

# emWin

Graphic Library with  
Graphic User Interface

User Guide & Reference Manual

Document: UM03001  
Software Version: 6.26  
Revision: 0  
Date: May 4, 2022

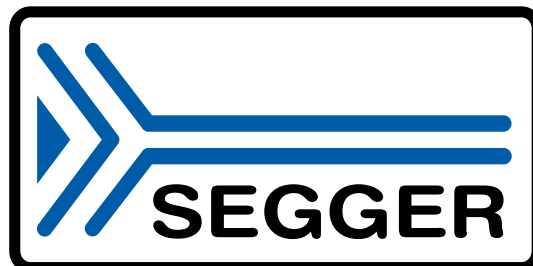

A product of SEGGER Microcontroller GmbH

[www.segger.com](http://www.segger.com)

## Disclaimer

The information written in this document is assumed to be accurate without guarantee. The information in this manual is subject to change for functional or performance improvements without notice. SEGGER Microcontroller GmbH (SEGGER) assumes no responsibility for any errors or omissions in this document. SEGGER disclaims any warranties or conditions, express, implied or statutory for the fitness of the product for a particular purpose. It is your sole responsibility to evaluate the fitness of the product for any specific use.

## Copyright notice

You may not extract portions of this manual or modify the PDF file in any way without the prior written permission of SEGGER. The software described in this document is furnished under a license and may only be used or copied in accordance with the terms of such a license.

© 2022 SEGGER Microcontroller GmbH, Monheim am Rhein / Germany

## Trademarks

Names mentioned in this manual may be trademarks of their respective companies.

Brand and product names are trademarks or registered trademarks of their respective holders.

## Contact address

SEGGER Microcontroller GmbH

Ecolab-Allee 5  
D-40789 Monheim am Rhein

Germany

Tel.           +49 2173-99312-0  
Fax.           +49 2173-99312-28  
E-mail:       support@segger.com\*  
Internet:     [www.segger.com](http://www.segger.com)

---

\*By sending us an email your (personal) data will automatically be processed. For further information please refer to our privacy policy which is available at <https://www.segger.com/legal/privacy-policy/>.

## Manual versions

This manual describes the current software version. If you find an error in the manual or a problem in the software, please inform us and we will try to assist you as soon as possible. Contact us for further information on topics or functions that are not yet documented.

Print date: May 4, 2022

| Software | Revision | Date   | By | Description   |
|----------|----------|--------|----|---|
| 6.26     | 0        | 220428 | FO | <p>Chapter <i>The Window Manager (WM)</i> updated.</p> <ul style="list-style-type: none"> <li>• New function WM_GetContentRect() added.</li> <li>• New function WM_GetContentRectEx() added.</li> <li>• New function WM_IsUntouchable() added.</li> </ul> <p>Chapter <i>Widgets</i> updated.</p> <ul style="list-style-type: none"> <li>• New SCROLLER widget added: smartphone-like scroll bar widget.</li> <li>• New WHEEL widget added: new and improved version of the LIST-WHEEL widget.</li> <li>• Parameters of SWIPELIST_GetOverlap() changed.</li> <li>• Parameters of SWIPELIST_SetOverlap() changed.</li> <li>• Parameters of SWIPELIST_GetDefaultOverlap() changed.</li> <li>• Parameters of SWIPELIST_SetDefaultOverlap() changed.</li> </ul>  |
| 6.24     | 0        | 220118 | FO | <p>Chapter <i>Configuration</i> updated.</p> <ul style="list-style-type: none"> <li>• New function GUI_SetOnLogFunc() added.</li> <li>• New function GUI_SetOnWarnFunc() added.</li> </ul> <p>Chapter <i>2-D Graphic Library</i> updated.</p> <ul style="list-style-type: none"> <li>• New function GUI_DrawArchREx() added.</li> <li>• New function GUI_DrawFrame() added.</li> <li>• New function GUI_DrawFrameEx() added.</li> </ul> <p>Chapter <i>Displaying bitmap files</i> updated.</p> <ul style="list-style-type: none"> <li>• Added "Limitations" sub-section to JPEG section.</li> </ul> <p>Chapter <i>Colors</i> updated.</p> <ul style="list-style-type: none"> <li>• Added new color conversion GUICC_666_18.</li> <li>• Added new color conversion GUICC_M666_18.</li> </ul> <p>Chapter <i>Widgets</i> updated.</p> <ul style="list-style-type: none"> <li>• New function DROPDOWN_Clear() added.</li> <li>• New function DROPDOWN_SetText() added.</li> <li>• New function HEADER_GetBorderH() added.</li> <li>• New function HEADER_GetBorderV() added.</li> <li>• New function HEADER_SetBorderH() added.</li> <li>• New function HEADER_SetBorderV() added.</li> <li>• New function LISTVIEW_Clear() added.</li> <li>• New function LISTVIEW_GetGridColor() added.</li> <li>• New function LISTVIEW_SetGridColor() added.</li> </ul> <p>Chapter <i>Anti-aliasing</i> updated.</p> <ul style="list-style-type: none"> <li>• New function GUI_AA_SetBufferSize() added.</li> </ul>   |
| 6.22     | 0        | 211116 | FO | <p>Chapter <i>Colors</i> updated.</p> <ul style="list-style-type: none"> <li>• New color conversion GUICC_8888I added.</li> </ul> <p>Chapter <i>Fonts</i> updated.</p> <ul style="list-style-type: none"> <li>• New function GUI_BDF_EmboldenFont() added.</li> <li>• New function GUI_BDF_EmboldenFontEx() added.</li> <li>• New function GUI_BDF_SetLetterSpacing() added.</li> <li>• New function GUI_FT_GetMeasurementChars() added.</li> <li>• New function GUI_FT_SetMeasurementChars() added.</li> <li>• New function GUI_TTF_EmboldenFont() added.</li> <li>• New function GUI_TTF_EmboldenFontEx() added.</li> <li>• New function GUI_TTF_ObliqueFont() added.</li> <li>• New function GUI_TTF_ObliqueFontEx() added.</li> </ul> <p>Chapter <i>The Window Manager (WM)</i> updated.</p> <ul style="list-style-type: none"> <li>• Section 'Widgets with motion support' added.</li> <li>• New function WM_DeleteWindowSecure() added.</li> </ul> <p>Chapter <i>Widgets</i> updated.</p> <ul style="list-style-type: none"> <li>• New function DROPDOWN_EnableMotion() added.</li> <li>• DROPDOWN widget now sends DROPDOWN_NOTIFICATION_COLLAPSED and DROPDOWN_NOTIFICATION_EXPANDED notifications to its parent.</li> <li>• New function LISTVIEW_GetDefaultBkColor() added.</li> <li>• New function LISTVIEW_GetDefaultFont() added.</li> <li>• New function LISTVIEW_GetDefaultGridColor() added.</li> <li>• New function LISTVIEW_GetDefaultScrollStepH() added.</li> <li>• New function LISTVIEW_GetDefaultTextColor() added.</li> <li>• New function LISTVIEW_SetDefaultScrollStepH() added.</li> <li>• New function LISTVIEW_SetScrollStepH() added.</li> <li>• New function LISTVIEW_GetScrollStepH() added.</li> </ul> |

| Software | Revision | Date   | By       | Description   |
|----------|----------|--------|----------|---|
|          |          |        |          | <ul style="list-style-type: none"> <li>• New function <code>LISTVIEW_SetScrollPos()</code> added.</li> <li>• New function <code>MULTIEDIT_GetDefaultAlign()</code> added.</li> <li>• New function <code>MULTIEDIT_GetDefaultBkColor()</code> added.</li> <li>• New function <code>MULTIEDIT_GetDefaultCursorColor()</code> added.</li> <li>• New function <code>MULTIEDIT_GetDefaultFont()</code> added.</li> <li>• New function <code>MULTIEDIT_GetDefaultHBorder()</code> added.</li> <li>• New function <code>MULTIEDIT_GetDefaultTextColor()</code> added.</li> <li>• New function <code>MULTIEDIT_SetDefaultAlign()</code> added.</li> <li>• New function <code>MULTIEDIT_SetDefaultBkColor()</code> added.</li> <li>• New function <code>MULTIEDIT_SetDefaultCursorColor()</code> added.</li> <li>• New function <code>MULTIEDIT_SetDefaultFont()</code> added.</li> <li>• New function <code>MULTIEDIT_SetDefaultHBorder()</code> added.</li> <li>• New function <code>MULTIEDIT_SetDefaultTextColor()</code> added.</li> <li>• New function <code>SWITCH_DisableAnimation()</code> added.</li> </ul> <p>SWIPELIST widget now sends notifications when its overlap area has been reached or released.<br/>Chapter <i>emWinView</i> updated.</p> <ul style="list-style-type: none"> <li>• Selection position and size can now be edited from a dialog.</li> </ul>   |
| 6.20     | 0        | 210810 | FO       | <p>Chapter <i>Displaying Text</i> updated.</p> <ul style="list-style-type: none"> <li>• New function <code>GUI_GetShowMissingCharacters()</code> added.</li> </ul> <p>Chapter <i>2-D Graphic Library</i> updated.</p> <ul style="list-style-type: none"> <li>• New function <code>GUI_DrawArcHR()</code> added.</li> <li>• New function <code>GUI_DrawPieHR()</code> added.</li> </ul> <p>Chapter <i>Fonts</i> updated.</p> <ul style="list-style-type: none"> <li>• 'Requirements' section added.</li> </ul> <p>Chapter <i>Movies</i> updated.</p> <ul style="list-style-type: none"> <li>• Bitmap-based emWin movie files added.</li> </ul> <p>Chapter <i>Widgets</i> updated.</p> <ul style="list-style-type: none"> <li>• New function <code>GAUGE_GetRange()</code> added.</li> <li>• Fixed mistakes in the SPINBOX configuration options table.</li> <li>• New function <code>IMAGE_SetAlign()</code> added.</li> <li>• New function <code>IMAGE_SetOffset()</code> added.</li> <li>• New function <code>IMAGE_SetAlpha()</code> added.</li> <li>• New function <code>IMAGE_SetAngle()</code> added.</li> <li>• New function <code>IMAGE_SetScale()</code> added.</li> <li>• New function <code>IMAGE_EnableLQ()</code> added.</li> </ul> <p>Chapter <i>VNC server</i> updated.</p> <ul style="list-style-type: none"> <li>• Multiple VNC connections to the same layer are now possible.</li> <li>• Section for connection with a web browser added.</li> </ul> <p>Chapter <i>Anti-aliasing</i> updated.</p> <ul style="list-style-type: none"> <li>• New function <code>GUI_AA_DrawPie()</code> added.</li> </ul> <p>Chapter <i>Bitmap Converter</i> updated.</p> <ul style="list-style-type: none"> <li>• Bitmap-based emWin movie files added.</li> </ul> <p>Chapter <i>Display drivers</i> updated.</p> <ul style="list-style-type: none"> <li>• <code>GUIDRV_SLinEPD_SSD1673</code> now supports SSD1680.</li> <li>• <code>GUIDRV_SLinEPD</code> now supports UC8451.</li> <li>• <code>GUIDRV_FlexColor</code> now supports ST7715.</li> </ul> <p>Chapter <i>Support</i> updated.</p> <ul style="list-style-type: none"> <li>• Fixed typo and updated FAQ.</li> </ul> |
| 6.18     | 0        | 210503 | JE<br>FO | <p>Chapter <i>Fonts</i> updated.</p> <ul style="list-style-type: none"> <li>• New function <code>GUI_BDF_CreateFont()</code> added.</li> <li>• New function <code>GUI_BDF_DeleteFont()</code> added.</li> <li>• New function <code>GUI_BDF_GetFamilyName()</code> added.</li> <li>• New function <code>GUI_BDF_GetStyleName()</code> added.</li> <li>• Function <code>GUI_TTF_DestroyCache()</code> renamed to <code>GUI_FT_DestroyCache()</code>.</li> <li>• Function <code>GUI_TTF_Done()</code> renamed to <code>GUI_FT_Done()</code>.</li> <li>• Function <code>GUI_TTF_SetCacheSize()</code> renamed to <code>GUI_FT_SetCacheSize()</code>.</li> <li>• New function <code>GUI_GetFallbackFont()</code> added.</li> <li>• New function <code>GUI_SetFallbackFont()</code> added.</li> <li>• New function <code>GUI_SetFuncGetFallbackFont()</code> added.</li> </ul> <p>Chapter <i>Font Converter</i> updated.</p> <ul style="list-style-type: none"> <li>• New command line options added added.</li> </ul> <p>Chapter <i>Simulation</i> updated.</p> <ul style="list-style-type: none"> <li>• New function <code>SIM_GUI_EnableModifierKey()</code> added.</li> <li>• New function <code>SIM_GUI_IsModifierKeyEnabled()</code> added.</li> </ul> <p>Chapter <i>Display drivers</i> updated.</p> <ul style="list-style-type: none"> <li>• <code>GUIDRV_FlexColor</code> supports Sitronix ST7626.</li> </ul> <p>Chapter <i>Memory Devices</i> updated.</p> <ul style="list-style-type: none"> <li>• New function <code>GUI_MEMDEV_GetBitsPerPixel()</code> added.</li> <li>• New function <code>GUI_MEMDEV_GetSelMemdev()</code> added.</li> </ul>   |



| Software | Revision | Date   | By | Description  |
|----------|----------|--------|----|--|
|          |          |        |    | <p>Chapter <i>2-D Graphic Library</i> updated.</p> <ul style="list-style-type: none"> <li>• New function <code>GUI_SetAfterExitHook()</code> added.</li> </ul> <p>Chapter <i>Animations</i> updated.</p> <ul style="list-style-type: none"> <li>• New function <code>GUI_ANIM_AddItemById()</code> added.</li> <li>• New function <code>GUI_ANIM_CreateWithId()</code> added.</li> <li>• New function <code>GUI_ANIM_DeleteById()</code> added.</li> <li>• New function <code>GUI_ANIM_Get()</code> added.</li> <li>• New function <code>GUI_ANIM_StartExId()</code> added.</li> <li>• New function <code>GUI_ANIM_StopById()</code> added.</li> </ul> <p>Chapter <i>Configuration</i> updated.</p> <ul style="list-style-type: none"> <li>• New function <code>GUI_SetFuncDrawCircle()</code> added.</li> <li>• New function <code>GUI_SetFuncDrawLine()</code> added.</li> <li>• New function <code>GUI_SetFuncDrawRoundedRect()</code> added.</li> <li>• New function <code>GUI_SetFuncFillCircle()</code> added.</li> <li>• New function <code>GUI_SetFuncFillRoundedRect()</code> added.</li> <li>• Table of currently existing ready to use hardware accelerators added.</li> <li>• Structure of sub chapters changed.</li> </ul> <p>Chapter <i>Widgets (window objects)</i> updated.</p> <ul style="list-style-type: none"> <li>• New function <code>LISTBOX_GetVisItemIndices()</code> added.</li> <li>• New function <code>LISTBOX_IsItemPartiallyVisible()</code> added.</li> <li>• New function <code>KEYBOARD_SetRadius()</code> added.</li> <li>• New function <code>KEYBOARD_SetSpace()</code> added.</li> <li>• Parameters changed of <code>LISTBOX_EnableMotion()</code>, <code>LISTVIEW_EnableMotion()</code> and <code>MULTIEDIT_EnableMotion()</code>. Calls of previous versions are not affected by this.</li> <li>• Added support of the following keys to <code>LISTBOX</code>: <code>GUI_KEY_HOME</code>, <code>GUI_KEY_END</code>, <code>GUI_KEY_PGUP</code>, <code>GUI_KEY_PGDOWN</code></li> </ul> <p>Chapter <i>'Viewer'</i> renamed to <i>emWinView</i>.</p> <ul style="list-style-type: none"> <li>• <code>emWinView</code> tool rewritten.</li> <li>• Added Selection/Measure tool.</li> <li>• Keyboard input gets send to <code>emWin</code> application.</li> <li>• Transparency is shown for multi-layer configurations.</li> </ul>  |
| 6.16     | 0        | 201120 | FO | <p>Chapter <i>2-D Graphic Library</i> updated.</p> <ul style="list-style-type: none"> <li>• New function <code>GUI_CreateBitmapFromStreamRLE1()</code> added.</li> </ul> <p>Chapter <i>Widgets (window objects)</i> updated.</p> <ul style="list-style-type: none"> <li>• New function <code>EDIT_GetMinMax()</code> added.</li> <li>• New function <code>SPINBOX_GetRange()</code> added.</li> <li>• New function <code>TEXT_GetFrameColor()</code> added.</li> <li>• New function <code>TEXT_GetDefaultFrameColor()</code> added.</li> <li>• New function <code>TEXT_SetFrameColor()</code> added.</li> <li>• New function <code>TEXT_SetDefaultFrameColor()</code> added.</li> <li>• <code>PROGBAR</code> now sends <code>WM_NOTIFICATION_VALUE_CHANGED</code> to parent when its value has changed.</li> <li>• New keyboard layout <code>KEYBOARD_ARA</code> for Arabic added.</li> <li>• New function <code>MULTIEDIT_EnableMotion()</code> added.</li> <li>• New function <code>MULTIEDIT_SetCursorColor()</code> added.</li> <li>• New function <code>MULTIEDIT_SetInvertCursor()</code> added.</li> <li>• New function <code>HEADER_SetColumnsResizable()</code> added.</li> <li>• New function <code>BUTTON_SetToggleMode()</code> added.</li> <li>• New function <code>BUTTON_Toggle()</code> added.</li> <li>• <code>BUTTON_REACT_ON_LEVEL</code> is now the default way how PID events are handled by a <code>BUTTON</code>.</li> <li>• New function <code>SWIPELIST_SetOverlap()</code> added.</li> <li>• New function <code>SWIPELIST_GetOverlap()</code> added.</li> <li>• New function <code>SWIPELIST_SetDefaultOverlap()</code> added.</li> <li>• New function <code>SWIPELIST_GetDefaultOverlap()</code> added.</li> <li>• New function <code>LISTVIEW_GetVisRowIndices()</code> added.</li> <li>• New function <code>LISTVIEW_IsRowPartiallyVisible()</code> added.</li> </ul> <p>Chapter <i>Anti-aliasing</i> updated.</p> <ul style="list-style-type: none"> <li>• New function <code>GUI_AA_DrawRoundedFrame()</code> added.</li> <li>• New function <code>GUI_AA_DrawRoundedFrameEx()</code> added.</li> </ul> <p>Chapter <i>Memory Devices</i> updated.</p> <ul style="list-style-type: none"> <li>• New function <code>GUI_MEMDEV_SerializeExBMP()</code> added.</li> <li>• Fixed color format issue in <code>GUI_MEMDEV_PunchOutDevice()</code> example.</li> </ul> <p>Chapter <i>AppWizard</i> updated.</p> <ul style="list-style-type: none"> <li>• New function <code>APPW_SetCustCallback()</code> added.</li> </ul> <p>Chapter <i>Bitmap Converter</i> updated.</p> <ul style="list-style-type: none"> <li>• Reading of C and DTA files added.</li> <li>• New bitmap format <code>RLE1</code> (compressed 1bpp) added.</li> <li>• Added section about memory footprint.</li> </ul> |
| 6.14     | 0        | 200602 | FO | <p>Structure of chapters reworked.</p> <p>Chapter <i>Introduction to emWin</i> updated.</p>  |

| Software | Revision | Date   | By | Description  |
|----------|----------|--------|----|--|
|          |          |        |    | <ul style="list-style-type: none"> <li>Added "Complete emWin system" diagram.</li> <li>Example section enhanced.</li> <li>Added information about AppWizard.</li> </ul> Chapter <i>Getting Started</i> updated. <ul style="list-style-type: none"> <li>Prep.bat, CC.bat and Lib.bat examples updated to GCC/Cortex-M4.</li> </ul> Chapter <i>Simulation</i> updated. <ul style="list-style-type: none"> <li>Hardkey bitmap examples updated.</li> </ul> Chapter <i>Fonts</i> updated. <ul style="list-style-type: none"> <li>New function GUI_GetTrailingBlankRows() added.</li> <li>New function GUI_GetLeadingBlankRows() added.</li> </ul> Chapter <i>The Window Manager (WM)</i> updated. <ul style="list-style-type: none"> <li>WM_GetUserData() now returns 0 if the given handle is NULL.</li> </ul> Chapter <i>Widgets (window objects)</i> updated. <ul style="list-style-type: none"> <li>New KEYBOARD widget added.</li> <li>New function KEYBOARD_CreateUser() added.</li> <li>New function KEYBOARD_CreateIndirect() added.</li> <li>New function KEYBOARD_ExportLayout() added.</li> <li>New function KEYBOARD_ExportPatternFile() added.</li> <li>New function KEYBOARD_SetLayout() added.</li> <li>New function KEYBOARD_SetStreamedLayout() added.</li> <li>New function KEYBOARD_SetColor() added.</li> <li>New function KEYBOARD_SetFont() added.</li> <li>New function KEYBOARD_SetPeriod() added.</li> <li>New function EDIT_EnableAutoScroll() added.</li> </ul> |
| 6.12     | 1        | 200417 | FO | Chapter <i>Displaying bitmap files</i> updated. <ul style="list-style-type: none"> <li>Added member Progressive to struct GUI_JPEG_INFO to tell whether or not the JPEG image is progressive.</li> </ul> Chapter <i>Anti-aliasing</i> updated. <ul style="list-style-type: none"> <li>New function GUI_AA_FillEllipseXL() added.</li> </ul>  |
| 6.12     | 0        | 200408 | FO | Chapter <i>2-D Graphic Library</i> updated. <ul style="list-style-type: none"> <li>New function GUI_QR_CreateFramed() added.</li> </ul> Chapter <i>Widgets (Window objects)</i> updated. <ul style="list-style-type: none"> <li>New GAUGE widget added.</li> <li>New function GAUGE_CreateIndirect() added.</li> <li>New function GAUGE_CreateUser() added.</li> <li>New function GAUGE_GetValue() added.</li> <li>New function GAUGE_SetAlign() added.</li> <li>New function GAUGE_SetBkColor() added.</li> <li>New function GAUGE_SetColor() added.</li> <li>New function GAUGE_SetOffset() added.</li> <li>New function GAUGE_SetRadius() added.</li> <li>New function GAUGE_SetRange() added.</li> <li>New function GAUGE_SetRoundedEnd() added.</li> <li>New function GAUGE_SetRoundedValue() added.</li> <li>New function GAUGE_SetValue() added.</li> <li>New function GAUGE_SetValueRange() added.</li> <li>New function GAUGE_SetWidth() added.</li> <li>New QR CODE widget added.</li> <li>New function QR_CODE_CreateIndirect() added.</li> <li>New function QR_CODE_CreateUser() added.</li> <li>New function QR_CODE_SetEccLevel() added.</li> <li>New function QR_CODE_SetNumModules() added.</li> <li>New function QR_CODE_SetPixelSize() added.</li> <li>New function QR_CODE_SetText() added.</li> <li>New function QR_CODE_SetWiFiText() added.</li> </ul>   |
| 6.10     | 4        | 200318 | FO | Chapter <i>AppWizard</i> updated. <ul style="list-style-type: none"> <li>New function APPW_GetFont() added.</li> </ul> Chapter <i>Widgets (window objects)</i> updated. <ul style="list-style-type: none"> <li>New function RADIO_GetImage() added.</li> <li>New function LISTVIEW_GetLBorder() added.</li> <li>New function LISTVIEW_GetRBorder() added.</li> <li>New function LISTVIEW_GetTextAlign() added.</li> <li>New function LISTVIEW_RowIsDisabled() added.</li> <li>New function IMAGE_SetTiled() added.</li> <li>New function IMAGE_GetImageSize() added.</li> <li>New function GRAPH_SetGridOffY() added.</li> <li>New function CHECKBOX_GetDefaultAlign() added.</li> <li>New function CHECKBOX_SetDefaultAlign() added.</li> <li>New function CALENDAR_ShowDate() added.</li> <li>New function CALENDAR_GetWeekday() added.</li> </ul> Chapter <i>Language Support</i> updated. <ul style="list-style-type: none"> <li>Updated section <i>Thai language support</i>.</li> </ul>  |

| Software | Revision | Date   | By | Description  |
|----------|----------|--------|----|--|
|          |          |        |    | <ul style="list-style-type: none"> <li>• New function <code>GUI_UC_EnableThai()</code> added.</li> </ul>   |
| 6.10     | 3        | 200313 | FO | <p>Chapter <i>Displaying Text</i> updated.</p> <ul style="list-style-type: none"> <li>• Added parameter to <code>GUI_GetCharFromPos()</code> to save character index.</li> </ul> <p>Chapter <i>Fonts</i> updated.</p> <ul style="list-style-type: none"> <li>• New function <code>GUI_GetStringDistXEx()</code> added.</li> </ul> <p>Chapter <i>Movies</i> updated.</p> <ul style="list-style-type: none"> <li>• New function <code>GUI_MOVIE_GetInfoH()</code> added.</li> <li>• New function <code>GUI_MOVIE_GetNumFrames()</code> added.</li> </ul> <p>Fixed a bug with <code>GUI_DrawBitmapEx()</code> where transparency wasn't drawn correctly.</p> <p>Chapter <i>Widgets (window objects)</i> updated.</p> <ul style="list-style-type: none"> <li>• Added the functionality of HOME and END keys to EDIT widget.</li> <li>• Added automatic horizontal text scrolling to EDIT widget.</li> <li>• New function <code>TEXT_GetRotation()</code> added.</li> <li>• New function <code>TEXT_SetRotation()</code> added.</li> <li>• New function <code>TEXT_SetDefaultRotation()</code> added.</li> <li>• New function <code>TEXT_GetDefaultRotation()</code> added.</li> <li>• New function <code>TEXT_GetTextOffset()</code> added.</li> <li>• New function <code>TEXT_SetTextOffset()</code> added.</li> </ul>  |
| 6.10     | 2        | 200218 | FO | <p>Chapter <i>Simulation</i> updated.</p> <ul style="list-style-type: none"> <li>• Screenshots updated.</li> <li>• <code>SIM_GUI_SetCompositeSize()</code> and <code>SIM_GUI_ShowDevice()</code> enhanced.</li> <li>• Added 'Data structures' section to Device simulation API.</li> <li>• Added 'Defines' section to Device simulation API.</li> </ul> <p>Chapter <i>Viewer</i> updated.</p> <ul style="list-style-type: none"> <li>• Screenshots updated.</li> </ul> <p>Chapter <i>AppWizard</i> updated.</p> <ul style="list-style-type: none"> <li>• Screenshots updated.</li> </ul> <p>Chapter <i>emWinSPY</i> updated.</p> <ul style="list-style-type: none"> <li>• Screenshots updated.</li> </ul> <p>Chapter <i>Displaying text</i> updated.</p> <ul style="list-style-type: none"> <li>• Added 'Defines' section to Text API.</li> <li>• Added 'Enumerations' section to Text API.</li> </ul> <p>Chapter <i>2-D Graphic Library</i> updated.</p> <ul style="list-style-type: none"> <li>• New function <code>GUI_DrawRoundedRectEx()</code> added.</li> <li>• New function <code>GUI_DrawRoundedFrameEx()</code> added.</li> <li>• Added 'Data structures' section to Graphic API.</li> <li>• Added 'Defines' section to Graphic API.</li> </ul> <p>Chapter <i>Displaying bitmap files</i> updated.</p> <ul style="list-style-type: none"> <li>• Added 'Data structures' section to JPEG API.</li> <li>• Added 'Data structures' section to GIF API.</li> </ul> <p>Chapter <i>Bitmap Converter</i> updated.</p> <ul style="list-style-type: none"> <li>• Screenshots updated.</li> </ul> <p>Chapter <i>Language Support</i> updated.</p> <ul style="list-style-type: none"> <li>• References to BiDi removed even if emWin is compiled with <code>GUI_SUPPORT_BIDI</code>. Calling of <code>GUI_UC_EnableBIDI()</code> now is mandatory.</li> </ul> <p>Chapter <i>Fonts</i> updated.</p> <ul style="list-style-type: none"> <li>• Added 'Data structures' section to Font API.</li> <li>• Added 'Defines' section to Font API.</li> </ul> <p>Chapter <i>Font Converter</i> updated.</p> <ul style="list-style-type: none"> <li>• Screenshots updated.</li> </ul> <p>Chapter <i>Movies</i> updated.</p> <ul style="list-style-type: none"> <li>• Screenshot updated.</li> <li>• Added 'Data structures' section to Movie API.</li> <li>• Added 'Defines' section to Movie API.</li> </ul> <p>Chapter <i>Animations</i> updated.</p> <ul style="list-style-type: none"> <li>• Added section <i>Using a delete callback function</i>.</li> <li>• Added 'Data structures' section to Animation API.</li> <li>• Added 'Defines' section to Animation API.</li> </ul> <p>Chapter <i>Colors</i> updated.</p> <ul style="list-style-type: none"> <li>• Screenshot updated.</li> </ul> <p>Chapter <i>Memory Devices</i></p> <ul style="list-style-type: none"> <li>• Added 'Defines' section to Memory Device API.</li> </ul> <p>Chapter <i>The Window Manager (WM)</i> updated.</p> <ul style="list-style-type: none"> <li>• Added 'Data structures' section to WM API.</li> <li>• Added 'Defines' section to WM API.</li> </ul> <p>Chapter <i>Widgets (window objects)</i> updated.</p> <ul style="list-style-type: none"> <li>• Added 'Defines' section to BUTTON API.</li> <li>• Added 'Defines' section to CHECKBOX API.</li> <li>• Added 'Defines' section to DROPDOWN API.</li> <li>• Added 'Defines' section to EDIT API.</li> <li>• Added 'Defines' section to FRAMEWIN API.</li> </ul> |

| Software | Revision | Date   | By | Description  |
|----------|----------|--------|----|--|
|          |          |        |    | <ul style="list-style-type: none"> <li>• Added 'Defines' section to GRAPH API.</li> <li>• New function GRAPH_DATA_XY_Clear() added.</li> <li>• New function GRAPH_DATA_XY_GetLineVis() added.</li> <li>• New function GRAPH_DATA_XY_GetPointVis() added.</li> <li>• New function GRAPH_DATA_XY_SetLineVis() added.</li> <li>• New function GRAPH_DATA_XY_SetPointVis() added.</li> <li>• New function HEADER_DeleteItem() added.</li> <li>• New function HEADER_GetSel() added.</li> <li>• New function HEADER_SetFixed() added.</li> <li>• New function HEADER_SetScrollPos() added.</li> <li>• Added 'Defines' section to ICONVIEW API.</li> <li>• Added 'Defines' section to IMAGE API.</li> <li>• Added 'Defines' section to LISTBOX API.</li> <li>• Added 'Defines' section to LISTVIEW API.</li> <li>• Added 'Defines' section to LISTWHEEL API.</li> <li>• Added 'Data structures' section to MENU API.</li> <li>• Added 'Defines' section to MENU API.</li> <li>• Added 'Defines' section to MULTIEDIT API.</li> <li>• Added 'Defines' section to MULTIPAGE API.</li> <li>• Added 'Defines' section to RADIO API.</li> <li>• New function RADIO_GetNumItems() added.</li> <li>• New function RADIO_GetSpacing() added.</li> <li>• New function RADIO_SetSpacing() added.</li> <li>• Added 'Defines' section to SCROLLBAR API.</li> <li>• Added 'Defines' section to SLIDER API.</li> <li>• Added 'Defines' section to SPINBOX API.</li> <li>• Added 'Defines' section to SWIPELIST API.</li> <li>• Added 'Defines' section to SWITCH API.</li> </ul> <p>Chapter <i>Dialogs</i> updated.</p> <ul style="list-style-type: none"> <li>• Added 'Data structures' section to CALENDAR API.</li> <li>• Added 'Defines' section to CALENDAR API.</li> <li>• Added 'Defines' section to CHOOSECOLOR API.</li> <li>• Added 'Data structures' section to CHOOSEFILE API.</li> <li>• Added 'Defines' section to CHOOSEFILE API.</li> </ul> <p>Chapter <i>MultiLayer / MultiDisplay support</i> updated.</p> <ul style="list-style-type: none"> <li>• Added 'Data structures' section to MultiLayer API.</li> </ul> <p>Chapter <i>MultiTouch support (MT)</i> updated.</p> <ul style="list-style-type: none"> <li>• Added 'Data structures' section to Basic buffer access API.</li> <li>• Added 'Defines' section to Basic buffer access API.</li> </ul> <p>Chapter <i>Cursors</i> updated.</p> <ul style="list-style-type: none"> <li>• Added 'Data structures' section to Cursor API.</li> </ul> <p>Chapter <i>VNC Server</i> updated.</p> <ul style="list-style-type: none"> <li>• Added 'Data structures' section to VNC Server API.</li> </ul> <p>Chapter <i>Indexes</i> updated.</p> <ul style="list-style-type: none"> <li>• Added 'Types' index for data structures.</li> </ul> |
| 6.10     | 1        | 200203 | JE | <p>Chapter <i>Display drivers</i> updated.</p> <ul style="list-style-type: none"> <li>• GUIDRV_SPage supports Sitronix ST7571, GUIDRV_SPage_Set1510()</li> </ul>   |
| 6.10     | 0        | 200106 | FO | <p>New chapter <i>AppWizard</i>.</p> <ul style="list-style-type: none"> <li>• New function APPW_SetVarData() added.</li> <li>• New function APPW_GetVarData() added.</li> </ul> <p>Chapter <i>Displaying Text</i> updated.</p> <ul style="list-style-type: none"> <li>• New function GUI_GetCharFromPos() added.</li> </ul> <p>Chapter <i>2-D Graphic Library</i> updated.</p> <ul style="list-style-type: none"> <li>• New function GUI_BARCODE_Draw() added.</li> <li>• New function GUI_BARCODE_GetXSize() added.</li> <li>• New function GUI_DrawGradientVEx() added.</li> <li>• New function GUI_DrawGradientHEX() added.</li> <li>• New function GUI_DrawGradientMVEx() added.</li> <li>• New function GUI_DrawGradientMHEX() added.</li> <li>• New function GUI_DrawGradientRoundedVEx() added.</li> <li>• New function GUI_DrawGradientRoundedHEX() added.</li> <li>• New function GUI_FillRoundedRectEx() added.</li> <li>• New function GUI_YUV_Create() added.</li> <li>• New function GUI_YUV_CreateEx() added.</li> <li>• New function GUI_YUV_Delete() added.</li> <li>• New function GUI_YUV_DeleteEx() added.</li> <li>• New function GUI_YUV_GetpData() added.</li> <li>• New function GUI_YUV_GetpDataEx() added.</li> <li>• New function GUI_YUV_InvalidArea() added.</li> <li>• New function GUI_YUV_SetPeriodEx() added.</li> <li>• New function GUI_YUV_SetPeriod() added.</li> </ul> <p>Chapter <i>Animations</i> updated.</p>  |

| Software | Revision | Date   | By | Description  |
|----------|----------|--------|----|--|
|          |          |        |    | <ul style="list-style-type: none"> <li>• New function GUI_ANIM_DeleteAll() added.</li> <li>• New function GUI_ANIM_GetFirst() added.</li> <li>• New function GUI_ANIM_GetNext() added.</li> <li>• New function GUI_ANIM_GetData() added.</li> <li>• New function GUI_ANIM_IsRunning() added.</li> <li>• New function GUI_ANIM_GetNumItems() added.</li> <li>• New function GUI_ANIM_GetItemData() added.</li> </ul> <p>Chapter <i>Widgets (window objects)</i> updated.</p> <ul style="list-style-type: none"> <li>• New ROTARY widget added.</li> <li>• New SWITCH widget added.</li> <li>• New function EDIT_GetCharAtPixel() added.</li> <li>• New function EDIT_GetSel() added.</li> <li>• New function EDIT_GetSelText() added.</li> <li>• New function GRAPH_DATA_YT_SetColor() added.</li> <li>• New function GRAPH_DATA_XY_SetColor() added.</li> <li>• New function HEADER_GetColumnFromPos() added.</li> <li>• New function LISTBOX_EnableMotion() added.</li> <li>• New function LISTVIEW_EnableMotion() added.</li> <li>• New function MULTIEDIT_GetNumChars() added.</li> <li>• New function MULTIEDIT_GetTextFromLine() added.</li> <li>• New function MULTIEDIT_GetTextFromPos() added.</li> <li>• New function MULTIPAGE_GetTabHeight() added.</li> <li>• New function MULTIPAGE_GetTabWidth() added.</li> <li>• New function MULTIPAGE_GetNumTabs() added.</li> <li>• New function SWIPELIST_IsSepItem() added.</li> <li>• Fixed a bug with the LISTVIEW widget where column headers would not move in fixed mode.</li> <li>• Fixed a bug with LISTWHEEL_SetItemData() that would cause a crash.</li> <li>• Fixed a bug where if SKINFLEX_PROPS were set only for the SPINBOX_SKINFLEX_PI_FOCUSED state, the lower button wasn't drawn correctly.</li> <li>• Fixed a bug where if DROPDOWN was collapsed it was possible to select disabled item by keyboard.</li> <li>• Fixed a bug where some widgets in a MULTIPAGE widget wouldn't get the focus.</li> </ul> <p>Chapter <i>Sprites</i> updated.</p> <ul style="list-style-type: none"> <li>• Fixed a bug where sprites weren't working with 1bpp bitmaps.</li> </ul> <p>Chapter <i>Anti-aliasing</i> updated.</p> <ul style="list-style-type: none"> <li>• Fixed a bug where GUI_AA_DrawLine() didn't draw a line in a window properly, added missing WM_ADDORG(x1, y1).</li> </ul> <p>Chapter <i>Display drivers</i> updated.</p> <ul style="list-style-type: none"> <li>• GUIDRV_FlexColor supports UC1698, GUIDRV_FlexColor_Func66725</li> </ul> <p>Chapter <i>VNC Server</i> updated.</p> <ul style="list-style-type: none"> <li>• emVNC is now available for MacOS and Linux.</li> <li>• New functions such as managing last connections, zooming in and out and fullscreen mode.</li> </ul> |
| 5.50     | 1        | 191015 | FO | Various corrections and improvements.  |
| 5.50     | 0        | 190528 | SC | <p>Chapter <i>Displaying Text</i> updated.</p> <ul style="list-style-type: none"> <li>• New function GUI_ShowMissingCharacters() added.</li> </ul> <p>Chapter <i>2-D Graphic Library</i> updated.</p> <ul style="list-style-type: none"> <li>• New function GUI_DrawGradientMH() added.</li> <li>• New function GUI_DrawGradientMV() added.</li> </ul> <p>Chapter <i>Memory Devices</i> updated.</p> <ul style="list-style-type: none"> <li>• New function GUI_MEMDEV_CreateCopy() added.</li> </ul> <p>Chapter <i>The Window Manager (WM)</i> updated.</p> <ul style="list-style-type: none"> <li>• New function WM_SetUntouchable() added.</li> </ul> <p>Chapter <i>Widgets (window objects)</i> updated.</p> <ul style="list-style-type: none"> <li>• New function GRAPH_InvertScrollBar() added.</li> <li>• New function GRAPH_DATA_YT/XY_SetColor() added.</li> <li>• New function KNOB_SetInvert() added.</li> <li>• New function KNOB_SetRotateHQ() added.</li> <li>• New function KNOB_SetRotateLQ() added.</li> <li>• New function SLIDER_EnableFocusRect() added.</li> <li>• New function SLIDER_SetInvertDir() added.</li> <li>• New function SPINBOX_SetTimerPeriod() added.</li> </ul> <p>Chapter <i>Display drivers</i> updated.</p> <ul style="list-style-type: none"> <li>• New driver GUIDRV_SLineEPD added.</li> <li>• New driver GUIDRV_SSD1322 added.</li> </ul> <p>Chapter <i>Configuration</i> updated.</p> <ul style="list-style-type: none"> <li>• New function GUI_AlphaEnableFillRectHW() added.</li> </ul>  |
| 5.48     | 0        | 180611 | SC | <p>Chapter <i>Displaying Text</i> updated.</p> <ul style="list-style-type: none"> <li>• New function GUI_SetClearTextRectMode() added.</li> </ul>  |



| Software | Revision | Date   | By | Description   |
|----------|----------|--------|----|---|
|          |          |        |    | <p>Chapter <i>The Window Manager (WM)</i> updated.</p> <ul style="list-style-type: none"> <li>• New function WM_Rect2Screen() added.</li> <li>• New function WM_Rect2Client() added.</li> <li>• New function WM_XY2Screen() added.</li> <li>• New function WM_XY2Client() added.</li> </ul> <p>Chapter <i>Widgets (window objects)</i> updated.</p> <ul style="list-style-type: none"> <li>• New function LISTBOX_SetFixedScrollPos() added.</li> </ul> <p>Chapter <i>Language Support</i> updated.</p> <ul style="list-style-type: none"> <li>• New function GUI_UC_SetEncodesJIS() added.</li> </ul> <p>Chapter <i>Display drivers</i> updated.</p> <ul style="list-style-type: none"> <li>• New function GUIDRV_FlexColor_SetOrientation() added.</li> <li>• New function GUIDRV_S1D13781_SetOrientation() added.</li> <li>• New function GUIDRV_S1D13L01_SetOrientation() added.</li> <li>• New function LCD_Refresh() added.</li> <li>• New function LCD_RefreshEx() added.</li> <li>• New function LCD_ROTATE_AddDriver() added.</li> <li>• New function LCD_ROTATE_AddDriverEx() added.</li> <li>• New function LCD_ROTATE_DecSel() added.</li> <li>• New function LCD_ROTATE_DecSelEx() added.</li> <li>• New function LCD_ROTATE_IncSel() added.</li> <li>• New function LCD_ROTATE_IncSelEx() added.</li> <li>• New function LCD_ROTATE_SetCallback() added.</li> <li>• New function LCD_ROTATE_SetSel() added.</li> <li>• New function LCD_ROTATE_SetSelEx() added.</li> <li>• GUIDRV_FlexColor support for SSD1353 added.</li> </ul> <p>Chapter <i>Configuration</i> updated.</p> <ul style="list-style-type: none"> <li>• New function GUI_ALLOC_GetMemInfo() added.</li> <li>• New function GUI_AA_SetFuncFillCircle() added.</li> <li>• New function GUI_AA_SetFuncFillPolygon() added.</li> <li>• New function GUI_AA_SetFuncDrawCircle() added.</li> <li>• New function GUI_AA_SetFuncDrawLine() added.</li> <li>• New function GUI_AA_SetFuncDrawPolyOutline() added.</li> <li>• New function GUI_AA_SetFuncDrawArc() added.</li> <li>• New function GUI_AA_SetpfStrcmp() added.</li> <li>• New function GUI_AA_SetpfStrcpy() added.</li> <li>• New function GUI_AA_SetpfStrlen() added.</li> </ul> |
| 5.46     | 0        | 171212 | SC | <p>Chapter <i>Introduction to emWin</i> updated.</p> <ul style="list-style-type: none"> <li>• Support of 64 bit data models added.</li> </ul> <p>Chapter <i>Bitmap Converter</i> updated.</p> <ul style="list-style-type: none"> <li>• Description of DTA files added.</li> </ul> <p>Chapter <i>The Window Manager (WM)</i> updated.</p> <ul style="list-style-type: none"> <li>• New message WM_SET_CALLBACK added.</li> <li>• Desktop window (WM_HBKWIN) is able to get user data now.</li> </ul> <p>Chapter <i>Widgets (window objects)</i> updated.</p> <ul style="list-style-type: none"> <li>• New function CHECKBOX_GetImage() added.</li> <li>• New function HEADER_GetItemText() added.</li> </ul> <p>Chapter <i>Display drivers</i> updated.</p> <ul style="list-style-type: none"> <li>• New function LCD_GetVRAMAddr() added.</li> <li>• New function LCD_GetVRAMAddrEx() added.</li> <li>• GUIDRV_FlexColor support for HX8367 added.</li> <li>• GUIDRV_SPage support for UC1628 added.</li> <li>• GUIDRV_SPage support for ST75320 added.</li> <li>• GUIDRV_SPage support for SSD1309 added.</li> </ul> <p>Chapter <i>Timing- and execution-related functions</i> updated.</p> <ul style="list-style-type: none"> <li>• renamed GUI_Error() to GUI_ErrorOut().</li> </ul>   |
| 5.44     | 1        | 171115 | SC | Fixed table description.  |
| 5.44     | 0        | 171020 | SC | <p>Chapter <i>emWin SPY</i> updated.</p> <ul style="list-style-type: none"> <li>• New function GUI_SPY_StartServerEx() added.</li> </ul> <p>Chapter <i>2-D Graphic Library</i> updated.</p> <ul style="list-style-type: none"> <li>• New function GUI_SPLINE_Create() added.</li> <li>• New function GUI_SPLINE_Draw() added.</li> <li>• New function GUI_SPLINE_Delete() added.</li> <li>• New function GUI_SPLINE_GetY() added.</li> <li>• New function GUI_SPLINE_GetXSize() added.</li> <li>• New function GUI_SPLINE_DrawAA() added.</li> </ul> <p>Chapter <i>Displaying bitmap files</i> updated.</p> <ul style="list-style-type: none"> <li>• New function GUI_JPEG_SetpfDrawEx() added.</li> </ul> <p>Chapter <i>Movies</i> updated.</p> <ul style="list-style-type: none"> <li>• New function GUI_MOVIE_SetpfNotify() added.</li> <li>• New functionality of displaying AVI files added.</li> </ul> <p>Chapter <i>The Window Manager (WM)</i> updated.</p>   |

| Software | Revision | Date   | By | Description  |
|----------|----------|--------|----|--|
|          |          |        |    | <ul style="list-style-type: none"> <li>• New message WM_USER_DATA added.</li> </ul> Chapter <i>Widgets (window objects)</i> updated. <ul style="list-style-type: none"> <li>• New function EDIT_GetTextAlign() added.</li> </ul> Chapter <i>Anti-aliasing</i> updated. <ul style="list-style-type: none"> <li>• New function GUI_AA_DrawCircle() added.</li> </ul> Chapter <i>Display drivers</i> updated. <ul style="list-style-type: none"> <li>• New driver GUIDRV_SH_MEM_3 added.</li> <li>• GUIDRV_FlexColor support for ST7775 added.</li> <li>• New function GUIDRV_SPage_SetUC1610() added.</li> <li>• GUIDRV_1611 removed, covered by GUIDRV_SPage.</li> </ul> Chapter <i>Configuration</i> updated. <ul style="list-style-type: none"> <li>• New function GUI_ALLOC_GetMaxUsedBytes() added.</li> <li>• New function GUI_RegisterAfterInitHook() added.</li> <li>• New functionality, interface for JPEG hardware support.</li> </ul>  |
| 5.42     | 0        | 170731 | SC | Chapter <i>Displaying Text</i> updated. <ul style="list-style-type: none"> <li>• New function GUI_DispStringInRectWrapEx() added.</li> <li>• New function GUI_SetStrikeWidth() added.</li> </ul> Chapter <i>2-D Graphic Library</i> updated. <ul style="list-style-type: none"> <li>• New function GUI_AddRect() added.</li> </ul> Chapter <i>Bitmap Converter</i> updated. <ul style="list-style-type: none"> <li>• Description about options dialog</li> </ul> Chapter <i>Widgets (window objects)</i> updated. <ul style="list-style-type: none"> <li>• New function CHECKBOX_GetBkColor() added.</li> <li>• New function CHECKBOX_GetBoxBkColor() added.</li> <li>• New function CHECKBOX_GetFocusColor() added.</li> <li>• New function CHECKBOX_GetFont() added.</li> <li>• New function CHECKBOX_GetTextAlign() added.</li> <li>• New function CHECKBOX_GetTextColor() added.</li> <li>• New function DROPDOWN_GetBkColor() added.</li> <li>• New function DROPDOWN_GetColor() added.</li> <li>• New function DROPDOWN_GetFont() added.</li> <li>• New function DROPDOWN_GetTextColor() added.</li> <li>• New function GRAPH_GetColor() added.</li> <li>• New function HEADER_GetFont() added.</li> <li>• New function ICONVIEW_GetBkColor() added.</li> <li>• New function ICONVIEW_GetFont() added.</li> <li>• New function ICONVIEW_GetTextColor() added.</li> <li>• New function ICONVIEW_GetReleasedItem() added.</li> <li>• New function LISTBOX_GetBkColor() added.</li> <li>• New function LISTBOX_GetTextColor() added.</li> <li>• New function MENU_GetBkColor() added.</li> <li>• New function MENU_GetFont() added.</li> <li>• New function MENU_GetTextColor() added.</li> <li>• New function MULTIEDIT_GetBkColor() added.</li> <li>• New function MULTIEDIT_GetFont() added.</li> <li>• New function MULTIEDIT_GetTextColor() added.</li> <li>• New function MULTIEDIT_ShowCursor() added.</li> <li>• New function MULTIPAGE_GetBkColor() added.</li> <li>• New function MULTIPAGE_GetTextColor() added.</li> <li>• New function PROGBAR_GetBarColor() added.</li> <li>• New function PROGBAR_GetFont() added.</li> <li>• New function RADIO_GetBkColor() added.</li> <li>• New function RADIO_GetFocusColor() added.</li> <li>• New function RADIO_GetFont() added.</li> <li>• New function RADIO_GetTextColor() added.</li> <li>• New function SCROLLBAR_GetColor() added.</li> <li>• New function SPINBOX_GetFont() added.</li> <li>• New function SPINBOX_GetTextColor() added.</li> <li>• New function TEXT_SetDec() added.</li> </ul> Chapter <i>Dialogs</i> updated. <ul style="list-style-type: none"> <li>• New function CALENDAR_AddKey() added.</li> </ul> Chapter <i>Display drivers</i> updated. <ul style="list-style-type: none"> <li>• 16bpp support for GUIDRV_S1D13L01 added.</li> <li>• 16bpp support for GUIDRV_S1D13781 added.</li> <li>• New function LCD_SetBufferPtr() added.</li> <li>• New function LCD_SetBufferPtrEx() added.</li> </ul> |
| 5.40     | 2        | 170524 | JE | Chapter <i>Displaying bitmap files</i> updated. <ul style="list-style-type: none"> <li>• Download link to PNG library changed.</li> </ul> Chapter <i>Fonts</i> updated. <ul style="list-style-type: none"> <li>• Download link to iType and iTypeSpark glue code changed.</li> <li>• Download link to Freetype library changed.</li> <li>• Description of XBF format added.</li> </ul>   |

| Software | Revision | Date   | By       | Description   |
|----------|----------|--------|----------|---|
| 5.40     | 1        | 170508 | JE       | <p>Chapter <i>Display drivers</i> updated.</p> <ul style="list-style-type: none"> <li>• New driver GUIDRV_S1D13L01 added</li> <li>• New driver GUIDRV_S1D13L02 added</li> <li>• New driver GUIDRV_S1D13L04 added</li> </ul>   |
| 5.40     | 0        | 170302 | JE       | <p>Chapter <i>Simulation</i> updated.</p> <ul style="list-style-type: none"> <li>• Function SIM_GUI_SaveCompositeBMP() added.</li> </ul> <p>Chapter <i>Displaying Text</i> updated.</p> <ul style="list-style-type: none"> <li>• Function GUI_WrapSetSeparators() added.</li> <li>• Function GUI_WrapGetPositions() added.</li> </ul> <p>Chapter <i>Movies</i> updated.</p> <ul style="list-style-type: none"> <li>• Function GUI_MOVIE_DrawFrame() added.</li> </ul> <p>Chapter <i>Widgets (window objects)</i> updated.</p> <ul style="list-style-type: none"> <li>• Function ICONVIEW_GetItemBitmap() added.</li> <li>• Function ICONVIEW_SetOwnerDraw() added.</li> <li>• Function MULTIEDIT_SetCursorCharPos() added.</li> <li>• Function MULTIEDIT_SetCursorPixelPos() added.</li> <li>• Function WIDGET_SetFocusable() added.</li> <li>• Function WIDGET_EnableStreamAuto() added.</li> </ul> <p>Chapter <i>Bitmap Converter</i> updated.</p> <ul style="list-style-type: none"> <li>• Bitmap Converter now supports JPEG files.</li> <li>• New command line option 'reducecolors' added.</li> <li>• New command line option 'hide' added.</li> <li>• New command line option 'scale' added.</li> </ul> <p>Chapter <i>The Window Manager (WM)</i> updated.</p> <ul style="list-style-type: none"> <li>• Function WM_GetNumInvalidWindows() added.</li> <li>• Function WM_MOTION_SetThreshold() added.</li> <li>• 'Overlapping' support added to WM_MOTION.</li> <li>• New variables added to WM_MOTION_INFO.</li> </ul> <p>Chapter <i>Display drivers</i> updated.</p> <ul style="list-style-type: none"> <li>• Function LCD_On() and LCD_OnEx() added.</li> <li>• Function LCD_Off() and LCD_OffEx() added.</li> </ul> <p>Chapter <i>Configuration</i> updated.</p> <ul style="list-style-type: none"> <li>• Function GUI_SetpfMemset() added.</li> <li>• Function GUI_SetpfMemcpy() added.</li> </ul>  |
| 5.38     | 0        | 161124 | JE<br>SC | <p>Chapter <i>Simulation</i> updated.</p> <ul style="list-style-type: none"> <li>• Function SIM_GUI_Delay() added.</li> <li>• Function SIM_GUI_ExecIdle() added.</li> <li>• Function SIM_GUI_GetTime() added.</li> </ul> <p>Chapter <i>2-D Graphic Library</i> updated.</p> <ul style="list-style-type: none"> <li>• Function GUI_GCACHE_4_Create() added.</li> <li>• Function GUI_GCACHE_4_CreateEx() added.</li> </ul> <p>Chapter <i>Fonts</i> updated.</p> <ul style="list-style-type: none"> <li>• Function GUI_GetDefaultFont() added.</li> </ul> <p>Chapter <i>Animations</i> updated.</p> <ul style="list-style-type: none"> <li>• Function GUI_ANIM_StartEx() added.</li> <li>• Function GUI_ANIM_Stop() added.</li> </ul> <p>Chapter <i>Colors</i> updated.</p> <ul style="list-style-type: none"> <li>• Function GUI_GetDefaultBkColor() added.</li> <li>• Function GUI_GetDefaultColor() added.</li> <li>• Function GUI_SetDefaultBkColor() added.</li> <li>• Function GUI_SetDefaultColor() added.</li> </ul> <p>Chapter <i>Memory Devices</i> updated.</p> <ul style="list-style-type: none"> <li>• Function GUI_MEMDEV_MULTIBUF_Enable() added.</li> </ul> <p>Chapter <i>The Window Manager (WM)</i> updated.</p> <ul style="list-style-type: none"> <li>• Explanation how to work with WM and multiple layers added.</li> </ul> <p>Chapter <i>Widgets (window objects)</i> updated.</p> <ul style="list-style-type: none"> <li>• MULTIEDIT: GUI_KEY_PGUP and GUI_KEY_PGDOWN added</li> </ul> <p>Chapter <i>Pointer Input Devices</i> updated.</p> <ul style="list-style-type: none"> <li>• Function GUI_PID_SetHook() added.</li> </ul> <p>Chapter <i>Display drivers</i> updated.</p> <ul style="list-style-type: none"> <li>• LCD_DEVFUNC_DRAWBMP_32BPP added to LCD_SetDevFunc().</li> <li>• New driver GUIDRV_S1D13513 added.</li> <li>• GUIDRV_FlexColor: 24bpp mode added to F66720.</li> </ul> <p>Chapter <i>VNC Server</i> updated.</p> <ul style="list-style-type: none"> <li>• Function GUI_VNC_SetRetryCount() added.</li> </ul> <p>Chapter <i>Timing and execution related functions</i> updated.</p> <ul style="list-style-type: none"> <li>• Function GUI_GetTimeSlice() added.</li> <li>• Function GUI_SetTimeSlice() added.</li> </ul> <p>Chapter <i>Configuration</i> updated.</p> <ul style="list-style-type: none"> <li>• Explanation added how to work with a frame buffer and DCACHE</li> <li>• Function GUI_SetFuncDrawAlpha() added.</li> <li>• Function GUI_DCACHE_Clear() added.</li> </ul> |



| Software | Revision | Date   | By | Description   |
|----------|----------|--------|----|---|
|          |          |        |    | <ul style="list-style-type: none"> <li>Function GUI_DCACHE_SetClearCacheHook() added.</li> </ul>  |
| 5.36     | 2        | 160906 | JE | Chapter <i>Performance and Resource usage</i> updated. <ul style="list-style-type: none"> <li>Performance values for ARM Cortex-M4 and A9 added</li> <li>Image performance values recalculated</li> </ul>   |
| 5.36     | 1        | 160901 | JE | Chapter <i>Display drivers</i> updated. <ul style="list-style-type: none"> <li>GUIDRV_FlexColor: 24bpp mode added</li> </ul>  |
| 5.36     | 0        | 160829 | JE | Chapter <i>Widgets (window objects)</i> updated. <ul style="list-style-type: none"> <li>Function SWIPELIST_GetThreshold() added.</li> <li>Function SWIPELIST_SetThreshold() added.</li> <li>Function SWIPELIST_SetDefaultThreshold() added.</li> <li>Function SWIPELIST_GetDefaultThreshold() added.</li> <li>Function GRAPH_DATA_YT_GetValue() added.</li> <li>Function GRAPH_DATA_XY_GetPoint() added.</li> </ul> Chapter <i>Anti-aliasing</i> updated. <ul style="list-style-type: none"> <li>Function GUI_AA_EnableGammaAA4() added.</li> <li>Function GUI_AA_SetGammaAA4() added.</li> <li>Function GUI_AA_GetGammaAA4() added.</li> </ul> Chapter <i>Language Support</i> updated. <ul style="list-style-type: none"> <li>Explanation of Unicode standard compatibility added.</li> <li>Function GUI_UC_SetBaseDir() added.</li> </ul> Chapter <i>Display drivers</i> updated. <ul style="list-style-type: none"> <li>Support for Sitronix ST7796 added to GUIDRV_FlexColor.</li> <li>Support for LDT LD7138 added to GUIDRV_FlexColor.</li> <li>Support for SP9230 added to GUIDRV_FlexColor.</li> <li>Support for IST3501 added to GUIDRV_SPage.</li> <li>Support for Sitronix ST7570 added to GUIDRV_SPage.</li> </ul>   |
| 5.34     | 2        | 160621 | JE | Chapter <i>Introduction</i> updated. <ul style="list-style-type: none"> <li>Compiler limitation added: 'char' needs to be 8 bit</li> </ul>  |
| 5.34     | 1        | 160517 | JE | Chapter <i>Display drivers</i> updated. <ul style="list-style-type: none"> <li>GUIDRV_SH_MEM: LS013B7DH06 removed, only b/w supported</li> </ul>  |
| 5.34     | 0        | 160425 | JE | Chapter <i>Getting Started</i> updated. <ul style="list-style-type: none"> <li>Function GUI_IsInitialized() added.</li> </ul> Chapter <i>Simulation</i> updated. <ul style="list-style-type: none"> <li>Function SIM_GUI_SaveBMP() added.</li> <li>Function SIM_GUI_SaveBMPEX added.</li> </ul> Chapter <i>2-D Graphic Library</i> updated. <ul style="list-style-type: none"> <li>Function GUI_QR_Create() added.</li> <li>Function GUI_QR_Delete() added.</li> <li>Function GUI_QR_Draw() added.</li> <li>Function GUI_QR_GetInfo() added.</li> <li>Function GUI_SetControlHook() added.</li> </ul> Chapter <i>Displaying bitmap files</i> updated. <ul style="list-style-type: none"> <li>Function GUI_BMP_EnableAlpha() added.</li> </ul> Chapter <i>Fonts</i> updated. <ul style="list-style-type: none"> <li>Support for iTypeSpark® font engine added.</li> </ul> Chapter <i>Widgets (window objects)</i> updated. <ul style="list-style-type: none"> <li>Function LISTBOX_GetOwner() added.</li> </ul> Chapter <i>Pointer Input Devices</i> updated. <ul style="list-style-type: none"> <li>Function GUI_PID_SetInitFunc() added.</li> </ul> Chapter <i>Display drivers</i> updated. <ul style="list-style-type: none"> <li>New display driver for Sharp Memory LCDs added</li> </ul> Chapter <i>VNC Server</i> updated. <ul style="list-style-type: none"> <li>File transfer capabilities added.</li> </ul> Chapter <i>Configuration</i> updated. <ul style="list-style-type: none"> <li>Macro GUI_POST_INIT added.</li> </ul> |
| 5.32     | 0        | 150930 | JE | Chapter <i>Simulation</i> updated. <ul style="list-style-type: none"> <li>Function SIM_GUI_GetCompositeTouch() added.</li> <li>Function SIM_GUI_SetCompositeTouch() added.</li> </ul> Chapter <i>emWinSPY</i> updated. <ul style="list-style-type: none"> <li>RTT connection added.</li> </ul> Chapter <i>Widgets (window objects)</i> updated. <ul style="list-style-type: none"> <li>New widget 'SWIPELIST' added.</li> <li>Function LISTVIEW_SetSelCol() added.</li> <li>Function SLIDER_GetRange() added.</li> <li>Function EDIT_EnableInversion() added.</li> </ul> Chapter <i>Language Support</i> updated. <ul style="list-style-type: none"> <li>Function GUI_LANG_GetLang() added.</li> </ul> Chapter <i>Display drivers</i> updated. <ul style="list-style-type: none"> <li>Commands added to LCD_X_DisplayDriver():</li> </ul>   |

| Software | Revision | Date   | By       | Description   |
|----------|----------|--------|----------|---|
|          |          |        |          | <ul style="list-style-type: none"> <li>• LCD_X_SHOWBUFFER, LCD_X_SETVIS, LCD_X_SETPOS, LCD_X_SETSIZE, LCD_X_SETALPHA</li> </ul>   |
| 5.30     | 0        | 150706 | JE<br>AS | <p>Chapter <i>2-D Graphic Library</i> updated.</p> <ul style="list-style-type: none"> <li>• Function GUI_PreserveTrans() added.</li> <li>• Function GUI_SetAlphaMask8888() added.</li> </ul> <p>Chapter <i>Bitmap Converter</i> updated.</p> <ul style="list-style-type: none"> <li>• Saving of PNGs now supported.</li> <li>• New bitmap format M8888I supported.</li> </ul> <p>Chapter <i>Font Converter</i> updated.</p> <ul style="list-style-type: none"> <li>• Loading of Adobe (B)itmap (D)istribution (F)ormat (BDF) added.</li> </ul> <p>Chapter <i>Animations</i> updated.</p> <ul style="list-style-type: none"> <li>• Function GUI_ANIM_AddItem() added.</li> <li>• Function GUI_ANIM_Create() added.</li> <li>• Function GUI_ANIM_Delete() added.</li> <li>• Function GUI_ANIM_Exec() added.</li> <li>• Function GUI_ANIM_Start() added.</li> </ul> <p>Chapter <i>Colors</i> updated.</p> <ul style="list-style-type: none"> <li>• New logical color mode ARGB added.</li> </ul> <p>Chapter <i>Memory Devices</i> updated.</p> <ul style="list-style-type: none"> <li>• Function GUI_MEMDEV_WriteOpaque() added.</li> <li>• Function GUI_MEMDEV_WriteOpaqueAt() added.</li> </ul> <p>Chapter <i>The Window Manager (WM)</i> updated.</p> <ul style="list-style-type: none"> <li>• Explanation of tiling algorithm added.</li> </ul> <p>Chapter <i>Widgets (window objects)</i> updated.</p> <ul style="list-style-type: none"> <li>• Function LISTWHEEL_IsMoving() added.</li> <li>• Function PROGBAR_GetMinMax() added.</li> <li>• Function PROGBAR_GetValue() added.</li> <li>• Function TEXT_GetBkColor() added.</li> <li>• Function TEXT_GetFont() added.</li> <li>• Function TEXT_GetTextAlign() added.</li> <li>• Function TEXT_GetTextColor() added.</li> <li>• Function TEXT_GetWrapMode() added.</li> <li>• Function TEXT_GetDefaultTextColor() added.</li> <li>• Function TEXT_GetDefaultWrapMode() added.</li> </ul> <p>Chapter <i>Display drivers</i> updated.</p> <ul style="list-style-type: none"> <li>• Support for HX8369 added to GUIDRV_FlexColor.</li> <li>• Support for ST7715 added to GUIDRV_FlexColor.</li> <li>• Support for SSD1325 added to GUIDRV_SLin.</li> </ul> |
| 5.28     | 1        | 150206 | JE       | Licensing information of TTF and PNG support changed.   |
| 5.28     | 0        | 150128 | JE<br>AS | <p>Chapter <i>Simulation</i> updated.</p> <ul style="list-style-type: none"> <li>• Function SIM_GUI_SetTransMode() added.</li> </ul> <p>New Chapter <i>emWinSPY</i> updated.</p> <ul style="list-style-type: none"> <li>• New tool emWinSPY added:</li> <li>• Function GUI_SPY_Process() added.</li> <li>• Function GUI_SPY_SetMemHandler() added.</li> <li>• Function GUI_SPY_StartServer() added.</li> <li>• Function GUI_SPY_X_StartServer() added.</li> </ul> <p>Chapter <i>2-D Graphic Library</i> updated.</p> <ul style="list-style-type: none"> <li>• Function GUI_SetRefreshHook() added.</li> </ul> <p>Chapter <i>Fonts</i> updated.</p> <ul style="list-style-type: none"> <li>• Commas added to standard digit fonts.</li> </ul> <p>Chapter <i>Widgets (window objects)</i> updated.</p> <ul style="list-style-type: none"> <li>• Some new default values added to FRAMEWIN and WINDOW.</li> <li>• Function LISTBOX_EnableWrapMode() added.</li> </ul> <p>Chapter <i>Multi layer / multi display support</i> updated.</p> <ul style="list-style-type: none"> <li>• Softlayers added:</li> <li>• Function GUI_SOFTLAYER_Enable() added.</li> <li>• Function GUI_SOFTLAYER_MULTIBUF_Enable() added.</li> <li>• Function GUI_SOFTLAYER_Refresh() added.</li> <li>• Function GUI_SOFTLAYER_SetCompositeColor() added.</li> </ul> <p>Chapter <i>Sprites</i> updated.</p> <ul style="list-style-type: none"> <li>• Sprites now support true color bitmaps with alpha blending.</li> </ul> <p>Chapter <i>Display drivers</i> updated.</p> <ul style="list-style-type: none"> <li>• LCD_DEVFUNC_DRAWBMP_8BPP added to LCD_SetDevFunc().</li> <li>• Support for ST7789 added to GUIDRV_FlexColor.</li> <li>• Support for UC1638 added to GUIDRV_SPage</li> <li>• Support for Avanti Electronics SBN0064G added to GUIDRV_SPage</li> <li>• New display driver GUIDRV_7528 added</li> </ul> <p>Chapter <i>Configuration</i> updated.</p> <ul style="list-style-type: none"> <li>• Function GUITASK_GetMaxTask() added.</li> <li>• Function GUICC_M1555I_SetCustColorConv() added.</li> </ul>   |

| Software | Revision | Date   | By       | Description   |
|----------|----------|--------|----------|---|
|          |          |        |          | <ul style="list-style-type: none"> <li>Function GUICC_M565_SetCustColorConv() added.</li> <li>Function GUICC_M4444I_SetCustColorConv() added.</li> <li>Function GUICC_M888_SetCustColorConv() added.</li> <li>Function GUICC_M8888I_SetCustColorConv() added.</li> <li>Function GUI_SetFuncAlphaBlending() added.</li> <li>Function GUI_SetFuncGetpPalConvTable() added.</li> <li>Function GUI_SetFuncMixColors() added.</li> <li>Function GUI_SetFuncMixColorsBulk() added.</li> <li>Function GUI_AA_SetpfDrawCharAA4() added.</li> <li>Function GUI_MEMDEV_SetDrawMemdev16bppFunc() added.</li> </ul>   |
| 5.26     | 2        | 141128 | AS       | Various corrections.  |
| 5.26     | 1        | 140821 | JE<br>AS | <p>Chapter <i>Widgets (window objects)</i> updated.</p> <ul style="list-style-type: none"> <li>Function MULTIPAGE_SetDefaultBorderSizeX() added.</li> <li>Function MULTIPAGE_SetDefaultBorderSizeY() added.</li> </ul> <p>Various corrections.</p>  |
| 5.26     | 0        | 140805 | JE<br>AS | <p>Chapter <i>2-D Graphic Library</i> updated.</p> <ul style="list-style-type: none"> <li>Function GUI_DIRTYDEVICE_Create() added.</li> <li>Function GUI_DIRTYDEVICE_CreateEx() added.</li> <li>Function GUI_DIRTYDEVICE_Delete() added.</li> <li>Function GUI_DIRTYDEVICE_DeleteEx() added.</li> <li>Function GUI_DIRTYDEVICE_Fetch() added.</li> <li>Function GUI_DIRTYDEVICE_FetchEx() added.</li> </ul> <p>Chapter <i>Bitmap Converter</i> updated.</p> <ul style="list-style-type: none"> <li>Dithering added.</li> </ul> <p>Chapter <i>Memory Devices</i> updated.</p> <ul style="list-style-type: none"> <li>Function GUI_MEMDEV_FadeOutDevices() added.</li> <li>Function GUI_MEMDEV_RotateHQAlpha() added.</li> <li>Function GUI_MEMDEV_RotateAlpha() added.</li> <li>Function GUI_MEMDEV_Dither32() added.</li> </ul> <p>Chapter <i>The Window Manager (WM)</i> updated.</p> <ul style="list-style-type: none"> <li>Function WM_GetScrollbarH() added.</li> <li>Function WM_GetScrollbarV() added.</li> <li>Function WM_SetModalLayer() added.</li> <li>Function WM_GetModalLayer() added.</li> </ul> <p>Chapter <i>Widgets (window objects)</i> updated.</p> <ul style="list-style-type: none"> <li>Function LISTVIEW_EnableCellSelect() added.</li> <li>Function LISTVIEW_GetItemRect() added.</li> <li>Function LISTVIEW_SetItemTextSorted() added.</li> <li>Function MULTIPAGE_EnableScrollBar() added.</li> <li>Function MULTIPAGE_SetBitmap() added.</li> <li>Function MULTIPAGE_SetBitmapEx() added.</li> <li>Function MULTIPAGE_SetTabHeight() added.</li> <li>Function MULTIPAGE_SetTabWidth() added.</li> <li>Function MULTIPAGE_SetTextAlign() added.</li> </ul> <p>Chapter <i>Anti-aliasing</i> updated.</p> <ul style="list-style-type: none"> <li>Function GUI_AA_FillEllipse() added.</li> </ul> <p>Chapter <i>Display drivers</i> updated.</p> <ul style="list-style-type: none"> <li>Support for LGDP4525 added to GUIDRV_FlexColor.</li> <li>Support for Ilitek ILI9488 added to GUIDRV_FlexColor.</li> <li>Support for Himax HX8357 added to GUIDRV_FlexColor.</li> <li>Support for Raio RA8875 added to GUIDRV_FlexColor.</li> <li>Support for OriseTech SPLC502B added to GUIDRV_SPage.</li> </ul> |
| 5.24     | 2        | 140429 | SC<br>AS | <p>Table titles were added for all tables except "Permitted values".</p> <p>Chapter <i>Colors</i> updated.</p> <ul style="list-style-type: none"> <li>Structure 'LCD_PHYSPALETTE' added.</li> <li>Section 'Look-up table API' added.</li> <li>Function 'LCD_SetLUT()' added.</li> <li>Function 'LCD_SetLUTEx()' added.</li> <li>Function 'LCD_SetLUTEntryEx()' added.</li> </ul>  |
| 5.24     | 1        | 140225 | SC<br>AS | Various corrections.  |
| 5.24     | 0        | 130801 | JE       | <p>Chapter <i>2-D Graphic Library</i> updated.</p> <ul style="list-style-type: none"> <li>New function GUI_CreateBitmapFromStreamA555() added.</li> <li>New function GUI_CreateBitmapFromStreamAM555() added.</li> <li>New function GUI_CreateBitmapFromStreamA565() added.</li> <li>New function GUI_CreateBitmapFromStreamAM565() added.</li> <li>New function GUI_DrawStreamedBitmapA555Ex() added.</li> <li>New function GUI_DrawStreamedBitmapAM555Ex() added.</li> <li>New function GUI_DrawStreamedBitmapA565Ex() added.</li> </ul>  |

| Software | Revision | Date   | By       | Description   |
|----------|----------|--------|----------|---|
|          |          |        |          | <ul style="list-style-type: none"> <li>• New function GUI_DrawStreamedBitmapAM565Ex() added.</li> </ul> Chapter <i>Bitmap Converter</i> updated. <ul style="list-style-type: none"> <li>• New bitmap formats added: 16bpp + 8 bit alpha channel.</li> </ul> Chapter <i>Fonts</i> updated. <ul style="list-style-type: none"> <li>• New function GUI_TTF_CreateFontAA() added.</li> </ul> Chapter <i>Memory Devices</i> updated. <ul style="list-style-type: none"> <li>• New function GUI_MEMDEV_ClearAlpha() added.</li> <li>• New function GUI_MEMDEV_CreateFixed32() added.</li> <li>• New function GUI_MEMDEV_BlendColor32() added.</li> </ul> Chapter <i>The Window Manager (WM)</i> updated. <ul style="list-style-type: none"> <li>• Circular motion support added.</li> </ul> Chapter <i>Widgets (window objects)</i> updated. <ul style="list-style-type: none"> <li>• New widget "KNOB" added.</li> <li>• New function LISTWHEEL_SetDeceleration() added.</li> <li>• New function DROPDOWN_SetListHeight() added.</li> <li>• New function LISTVIEW_OwnerDraw() added.</li> <li>• New function LISTVIEW_SetOwnerDraw() added.</li> <li>• New function LISTVIEW_GetWrapMode() added.</li> <li>• New function MULTIPAGE_GetPageText() added.</li> <li>• New function SPINBOX_SetEditMode() added.</li> <li>• New function SPINBOX_SetStep() added.</li> </ul> New Chapter <i>MultiTouch</i> added. <ul style="list-style-type: none"> <li>• New function GUI_MTOUCH_Enable() added.</li> <li>• New function GUI_MTOUCH_GetEvent() added.</li> <li>• New function GUI_MTOUCH_GetTouchInput() added.</li> <li>• New function GUI_MTOUCH_IsEmpty() added.</li> <li>• New function GUI_MTOUCH_SetOrientation() added.</li> <li>• New function GUI_MTOUCH_SetOrientationEx() added.</li> <li>• New function GUI_MTOUCH_StoreEvent() added.</li> <li>• New function WM_EnableGestures() added.</li> </ul> Chapter <i>Anti-aliasing</i> updated. <ul style="list-style-type: none"> <li>• New function GUI_AA_PreserveTrans() added.</li> </ul> Chapter <i>Language Support</i> updated. <ul style="list-style-type: none"> <li>• Remark that Devanagari transitions are not supported.</li> </ul> Chapter <i>Display drivers</i> updated. <ul style="list-style-type: none"> <li>• New function LCD_SetChromaEx() added.</li> <li>• New function LCD_SetChromaModeEx() added.</li> <li>• New function LCD_SetAlpha() added.</li> <li>• New function LCD_SetAlphaModeEx() added.</li> <li>• New function LCD_SetVisEx() added.</li> <li>• Support for Ilitek ILI9163 added to GUIDRV_FlexColor.</li> <li>• Support for RAI08870 added to GUIDRV_FlexColor.</li> <li>• Support for Solomon SSD1351 added to GUIDRV_FlexColor.</li> <li>• Support for RAI0 8835 added to GUIDRV_SLin.</li> <li>• Support for Samsung S6B0108 added to GUIDRV_SPage.</li> <li>• Support for Hitachi HD61202 added to GUIDRV_SPage.</li> </ul> Chapter <i>Touch drivers</i> updated. <ul style="list-style-type: none"> <li>• New multi touch driver added for PIXCIR TangoC32.</li> </ul> Chapter <i>Performance and Resource Usage</i> updated. <ul style="list-style-type: none"> <li>• New sub chapter 'Optimizing Footprint' added.</li> </ul> |
| 5.22     | 2        | 140108 | AS       | GUIDRV_CompactColor_16: <ul style="list-style-type: none"> <li>• Support for Samsung S6D0128 added to 66772.</li> <li>• Support for Sitronix ST7789 added to 66717.</li> </ul>  |
| 5.22     | 1        | 130801 | AS       | Various corrections.  |
| 5.22     | 0        | 130625 | JE<br>AS | New chapter <i>Movies</i> added.<br>Chapter <i>Colors</i> updated. <ul style="list-style-type: none"> <li>• New color conversion GUICC_8 added.</li> </ul> Chapter <i>Memory Devices</i> updated. <ul style="list-style-type: none"> <li>• New function GUI_MEMDEV_BlendWinBk() added.</li> <li>• New function GUI_MEMDEV_BlurAndBlendWinBk() added.</li> <li>• New function GUI_MEMDEV_BlurWinBk() added.</li> <li>• New function GUI_MEMDEV_CreateBlurredDevice32() added.</li> <li>• New function GUI_MEMDEV_CreateBlurredDevice32HQ() added.</li> <li>• New function GUI_MEMDEV_CreateBlurredDevice32LQ() added.</li> <li>• New function GUI_MEMDEV_PunchOutDevice() added.</li> <li>• New function GUI_MEMDEV_RotateHQHR() added.</li> <li>• New function GUI_MEMDEV_RotateHR() added.</li> <li>• New function GUI_MEMDEV_SetBlurHQ() added.</li> <li>• New function GUI_MEMDEV_SetBlurLQ() added.</li> </ul> Chapter <i>Widgets (window objects)</i> updated. <ul style="list-style-type: none"> <li>• Added notification messages sent by the IMAGE widget.</li> </ul>   |

| Software | Revision | Date   | By | Description  |
|----------|----------|--------|----|--|
|          |          |        |    | <ul style="list-style-type: none"> <li>• Added notification messages sent by the TEXT widget.</li> <li>• New function GRAPH_SetAutoScrollbar() added.</li> <li>• New function GRAPH_GetScrollValue() added.</li> <li>• New function GRAPH_SetScrollValue() added.</li> <li>• New function ICONVIEW_SetIconAlign() added.</li> <li>• New function LISTWHEEL_GetItemFromPos() added.</li> <li>• New function MULTIEDIT_SetFocussable() added.</li> <li>• New function MULTIPAGE_GetPageText() added.</li> <li>• New function TREEVIEW_ScrollToSel() added.</li> <li>• New section 'Custom widgets' added.</li> </ul> Chapter <i>Sprites</i> updated. <ul style="list-style-type: none"> <li>• New function GUI_SPRITE_SetLoop() added.</li> <li>• New function GUI_SPRITE_StartAnim() added.</li> <li>• New function GUI_SPRITE_StopAnim() added.</li> </ul> Chapter <i>Anti-aliasing</i> updated. <ul style="list-style-type: none"> <li>• New function GUI_AA_FillRoundedRect() added.</li> <li>• New function GUI_AA_FillRoundedRectEx() added.</li> <li>• New function GUI_AA_DrawRoundedRect() added.</li> <li>• New function GUI_AA_DrawRoundedRectEx() added.</li> </ul> Chapter <i>Display drivers</i> updated. <ul style="list-style-type: none"> <li>• New display driver GUIDRV_UC1698G added.</li> <li>• Support for Solomon SSD1306 added to GUIDRV_SPage.</li> </ul> Chapter <i>Timing- and execution-related functions</i> updated. <ul style="list-style-type: none"> <li>• New function GUI_TIMER_Create() added.</li> <li>• New function GUI_TIMER_Delete() added.</li> <li>• New function GUI_TIMER_Restart() added.</li> <li>• New function GUI_TIMER_SetPeriod() added.</li> </ul>  |
| 5.20     | 4        | 130409 | AS | GUIDRV_SPage: <ul style="list-style-type: none"> <li>• Support for Solomon SSD1305 added to 1510.</li> </ul>   |
| 5.20     | 3        | 130409 | AS | Various corrections / improvements.  |
| 5.20     | 2        | 130308 | AS | Chapter <i>Language Support</i> updated. <ul style="list-style-type: none"> <li>• New function GUI_LANG_GetTextBuffered() added.</li> <li>• New function GUI_LANG_GetTextBufferedEx() added.</li> </ul>  |
| 5.20     | 1        | 130305 | AS | Chapter <i>Skimming</i> updated. <ul style="list-style-type: none"> <li>• New function CHECKBOX_GetSkinFlexButtonSize() added.</li> <li>• New function CHECKBOX_SetSkinFlexButtonSize() added.</li> </ul>  |
| 5.20     | 0        | 130218 | JE | Chapter <i>Fonts</i> updated. <ul style="list-style-type: none"> <li>• Support for iType® fonts of Monotype Imaging added.</li> </ul> Chapter <i>Colors</i> updated. <ul style="list-style-type: none"> <li>• New color conversions added: GUICC_M8888I, GUICC_M1555I, GUICC_M4444I, GUICC_1616I, GUICC_88666I</li> </ul> Chapter <i>Dialogs</i> updated. <ul style="list-style-type: none"> <li>• CALENDAR dialog and functions added:               <ul style="list-style-type: none"> <li>• CALENDAR_Create()</li> <li>• CALENDAR_GetDate()</li> <li>• CALENDAR_GetSel()</li> <li>• CALENDAR_SetDate()</li> <li>• CALENDAR_SetSel()</li> <li>• CALENDAR_SetDefaultBkColor()</li> <li>• CALENDAR_SetDefaultColor()</li> <li>• CALENDAR_SetDefaultDays()</li> <li>• CALENDAR_SetDefaultFont()</li> <li>• CALENDAR_SetDefaultMonths()</li> <li>• CALENDAR_SetDefaultSize()</li> </ul> </li> </ul> Chapter <i>Sprites</i> updated. <ul style="list-style-type: none"> <li>• New function GUI_SPRITE_CreateHidden() added.</li> <li>• New function GUI_SPRITE_CreateHiddenEx() added.</li> </ul> Chapter <i>Display drivers</i> updated. <ul style="list-style-type: none"> <li>• GUIDRV_FlexColor:               <ul style="list-style-type: none"> <li>• Support for Himax HX8340 added to 66712.</li> <li>• New module 66772 added with support for: Hitachi HD66772, Samsung S6D0117, Sitronix ST7712, Himax HX8301, Ilitek ILI9220 and ILI9221</li> <li>• GUIDRV_SLin: Support for Epson S1D13305 added.</li> </ul> </li> </ul> Chapter <i>VNC Server</i> updated. <ul style="list-style-type: none"> <li>• New function GUI_VNC_SetLockFrame() added.</li> </ul> Chapter <i>Timing and execution</i> updated. <ul style="list-style-type: none"> <li>• New function GUI_Error() added.</li> </ul> Chapter <i>Configuration</i> updated. <ul style="list-style-type: none"> <li>• New function GUI_SetOnErrorFunc() added.</li> </ul> |

| Software | Revision | Date   | By       | Description   |
|----------|----------|--------|----------|---|
| 5.18     | 0        | 120917 | JE<br>AS | <p>Chapter <i>Displaying bitmap files</i> updated.</p> <ul style="list-style-type: none"> <li>• New function <code>GUI_BMP_SerializeExBpp()</code> added.</li> </ul> <p>Chapter <i>Bitmap Converter</i> updated.</p> <ul style="list-style-type: none"> <li>• New functions added to create animated sprites and cursors out of animated GIF files.</li> </ul> <p>Chapter <i>Memory Devices</i> updated.</p> <ul style="list-style-type: none"> <li>• New function <code>GUI_MEMDEV_SerializeBMP()</code> added.</li> </ul> <p>Chapter <i>The Window Manager (WM)</i> updated.</p> <ul style="list-style-type: none"> <li>• New function <code>WM_SetCaptureMove()</code> added.</li> <li>• New function <code>WM_Screen2hWin()</code> added.</li> <li>• New function <code>WM_Screen2hWinEx()</code> added.</li> </ul> <p>Chapter <i>Widgets (window objects)</i> updated.</p> <ul style="list-style-type: none"> <li>• New functions added:</li> <li>• <code>TEXT_GetText()</code></li> <li>• <code>LISTVIEW_SetWrapMode()</code></li> </ul> <p>Chapter <i>Anti-aliasing</i> updated.</p> <ul style="list-style-type: none"> <li>• New function <code>GUI_AA_SetDrawMode()</code> added.</li> </ul> <p>Chapter <i>Language Support</i> updated.</p> <ul style="list-style-type: none"> <li>• New feature "Text" and language resource files" added.</li> </ul> <p>Chapter <i>Display drivers</i> updated.</p> <ul style="list-style-type: none"> <li>• <code>GUIDRV_FlexColor</code>:</li> <li>• Function <code>GUIDRV_FlexColor_SetInterface66709_B16()</code> replaced by the function <code>GUIDRV_FlexColor_SetReadFunc66709_B16()</code>.</li> <li>• Function <code>GUIDRV_FlexColor_SetInterface66720_B16()</code> replaced by the function <code>GUIDRV_FlexColor_SetReadFunc66720_B16()</code>.</li> <li>• New module 66702 added: Solomon SSD1284, SSD1289, SSD1298</li> <li>• New module 66715 added: Himax HX8352B</li> <li>• Recommended calling sequence for configuration functions added.</li> <li>• <code>GUIDRV_S1D13781</code>:</li> <li>• Additional information about initialized registers added.</li> </ul> |
| 5.16     | 2        | 120809 | AS       | <p>Chapter <i>Widgets (window objects)</i> updated.</p> <ul style="list-style-type: none"> <li>• New function <code>SPINBOX_SetRange()</code> added.</li> </ul> <p>Various corrections.</p>   |
| 5.16     | 1        | 120628 | AS       | <p>Chapter <i>The Window Manager (WM)</i> updated.</p> <ul style="list-style-type: none"> <li>• Descriptions of the following functions reworked:</li> <li>• <code>WM_GetScrollPosH()</code></li> <li>• <code>WM_GetScrollPosV()</code></li> <li>• <code>WM_SetScrollPosH()</code></li> <li>• <code>WM_SetScrollPosV()</code></li> <li>• Preface, About and Chapter <i>Introduction</i> reworked.</li> </ul>  |
| 5.16     | 0        | 120605 | JE<br>AS | <p>Chapter <i>Colors</i> updated.</p> <ul style="list-style-type: none"> <li>• New color conversion routine added to support 1bpp at different color depths.</li> </ul> <p>Chapter <i>Memory Devices</i> updated.</p> <ul style="list-style-type: none"> <li>• New function <code>GUI_MEMDEV_RotateHQT()</code> added.</li> </ul> <p>Chapter <i>The Window Manager (WM)</i> updated.</p> <ul style="list-style-type: none"> <li>• Support for ToolTips added.</li> <li>• New functions added:</li> <li>• <code>WM_TOOLTIP_AddTool()</code></li> <li>• <code>WM_TOOLTIP_Create()</code></li> <li>• <code>WM_TOOLTIP_Delete()</code></li> <li>• <code>WM_TOOLTIP_SetDefaultFont()</code></li> <li>• <code>WM_TOOLTIP_SetDefaultColor()</code></li> <li>• <code>WM_TOOLTIP_SetDefaultPeriod()</code></li> </ul> <p>Chapter <i>Widgets (window objects)</i> updated.</p> <ul style="list-style-type: none"> <li>• New functions added:</li> <li>• <code>BUTTON_SetReactOnTouch()</code></li> <li>• <code>DROPDOWN_SetUpMode()</code></li> <li>• <code>ICONVIEW_EnableStreamAuto()</code></li> </ul> <p>Changed function <code>SPINBOX_SetButtonSize()</code>:</p> <ul style="list-style-type: none"> <li>• New option <code>SPINBOX_EDGE_CENTER</code>.</li> </ul> <p>Chapter <i>Dialogs</i> updated.</p> <ul style="list-style-type: none"> <li>• <code>CHOOSECOLOR</code> dialog and functions added:</li> <li>• <code>CHOOSECOLOR_Create()</code></li> <li>• <code>CHOOSECOLOR_GetSel()</code></li> <li>• <code>CHOOSECOLOR_SetSel()</code></li> <li>• <code>CHOOSECOLOR_SetDefaultColor()</code></li> <li>• <code>CHOOSECOLOR_SetDefaultSpace()</code></li> <li>• <code>CHOOSECOLOR_SetDefaultBorder()</code></li> <li>• <code>CHOOSECOLOR_SetDefaultButtonSize()</code></li> <li>• <code>CHOOSEFILE_EnableToolTips()</code></li> </ul>   |



| Software | Revision | Date   | By | Description  |
|----------|----------|--------|----|--|
|          |          |        |    | <ul style="list-style-type: none"> <li>• CHOOSEFILE_SetButtonText()</li> <li>• CHOOSEFILE_SetDefaultButtonText()</li> <li>• CHOOSEFILE_SetToolTips()</li> <li>• CHOOSEFILE_SetTopMode()</li> </ul> <p>Chapter <i>Pointer Input Devices</i> updated.</p> <ul style="list-style-type: none"> <li>• New function GUI_PID_IsPressed() added.</li> </ul> <p>Chapter <i>Keyboard Input</i> updated.</p> <ul style="list-style-type: none"> <li>• New function GUI_GetKeyState() added.</li> </ul> <p>Chapter <i>Language Support</i> updated.</p> <ul style="list-style-type: none"> <li>• New function GUI_LANG_GetNumItems() added.</li> </ul> <p>Chapter <i>Language Support</i> updated.</p> <ul style="list-style-type: none"> <li>• New function GUI_LANG_GetText() added.</li> <li>• New function GUI_LANG_GetTextEx() added.</li> <li>• New function GUI_LANG_LoadCSV() added.</li> <li>• New function GUI_LANG_LoadCSVEx() added.</li> <li>• New function GUI_LANG_LoadText() added.</li> <li>• New function GUI_LANG_LoadTextEx() added.</li> <li>• New function GUI_LANG_SetLang() added.</li> <li>• New function GUI_LANG_SetMaxNumLang() added.</li> <li>• New function GUI_LANG_SetSep() added.</li> </ul> <p>Chapter <i>Display drivers</i> updated.</p> <ul style="list-style-type: none"> <li>• New display controller supported by</li> <li>• GUIDRV_SPage, GUIDRV_SPage_Set1510:</li> <li>• Epson S1D15605, S1D15606, S1D15607, S1D15608, S1D15705, S1D15710, S1D15714</li> <li>• Integrated Solutions Technology IST3020</li> <li>• New Japan Radio Company NJU6676</li> <li>• Novatek NT7502, NT7534, NT7538, NT75451</li> <li>• Samsung S6B0719, S6B0713, S6B0724, S6B1713</li> <li>• Sino Wealth SH1101A</li> <li>• Sitronix ST7522, ST7565, ST7567</li> <li>• Solomon SSD1303, SSD1805, SSD1815, SSD1821</li> <li>• Sunplus SPLC501C</li> <li>• UltraChip UC1608, UC1701, UC1601, UC1606</li> <li>• GUIDRV_SPage_Set1512:</li> <li>• Epson S1D15E05, S1D15E06, S1D15719, S1D15721</li> <li>• GUIDRV_SPage_SetST7591: Sitronix ST7591</li> <li>• New display controllers supported by GUIDRV_FlexColor:</li> <li>• 66708: Ilitek ILI9335</li> <li>• 66709: Ilitek ILI9338, ILI9340, ILI9341, ILI9342</li> <li>• 66719: Samsung S6E63D6</li> <li>• New function LCD_SetMaxNumColors() added.</li> <li>• Support for 1bpp added to GUIDRV_SPage.</li> <li>• Function GUIDRV_SPage_SetS1D15() obsolete, replaced by GUIDRV_SPage_Set1512</li> <li>• New variants GUIDRV_Lin added:</li> <li>• GUIDRV_LIN_OX_8</li> <li>• GUIDRV_LIN_OXY_8</li> <li>• New driver GUIDRV_S1D13781 added.</li> </ul> <p>New chapter <i>Touch drivers</i> added.</p> <ul style="list-style-type: none"> <li>• New driver GUITDRV_ADS7846 added.</li> </ul> |
| 5.14     | 3        | 120202 | AS | <p>Chapter <i>Display drivers</i> updated.</p> <ul style="list-style-type: none"> <li>• New display controller supported by GUIDRV_FlexColor:</li> <li>• 66709: Ilitek ILI9340</li> <li>• New display controllers supported by GUIDRV_SPage:</li> <li>• Epson S1D15605, S1D15606, S1D15607, S1D15608, S1D15705, S1D15710, S1D15714</li> <li>• Integrated Solutions Technology IST3020</li> <li>• New Japan Radio Company NJU6676</li> <li>• Novatek NT7502, NT7534, NT7538, NT75451</li> <li>• Samsung S6B0719, S6B0713, S6B0724, S6B1713</li> <li>• Sino Wealth SH1101A</li> <li>• Sitronix ST7522, ST7565, ST7567</li> <li>• Solomon SSD1805, SSD1303, SSD1815</li> <li>• UltraChip UC1608, UC1701, UC1601, UC1606</li> <li>• Sunplus SPLC501C</li> <li>• New function GUIDRV_SPage_Set1510 added.</li> <li>• New function GUIDRV_SPage_Set1512 added.</li> </ul>  |
| 5.14     | 2        | 120201 | AS | <p>Chapter <i>Displaying bitmaps files</i> updated.</p> <ul style="list-style-type: none"> <li>• Improved description of the 'GetData'-function.</li> </ul> <p>Chapter <i>Display drivers</i> updated.</p> <ul style="list-style-type: none"> <li>• GUIDRV_SPage now supports 1bpp.</li> </ul>   |

| Software | Revision | Date   | By       | Description   |
|----------|----------|--------|----------|---|
|          |          |        |          | <ul style="list-style-type: none"> <li>• New display controllers supported by GUIDRV_SPage:</li> <li>• Epson S1D15E05, S1D15E06, S1D15719, S1D15721</li> <li>• Sitronix ST7591</li> <li>• New function GUIDRV_SPage_SetST7591 added.</li> </ul>   |
| 5.14     | 1        | 120124 | AS       | <p>Chapter <i>Widgets (window objects)</i> updated.</p> <ul style="list-style-type: none"> <li>• New function EDIT_GetTextColor().</li> <li>• New function SPINBOX_GetEditHandle().</li> </ul>  |
| 5.14     | 0        | 120111 | JE<br>AS | <p>Chapter <i>Simulation</i> updated.</p> <ul style="list-style-type: none"> <li>• New function SIM_GUI_Enable() added.</li> </ul> <p>Chapter <i>2-D Graphic Library</i> updated.</p> <ul style="list-style-type: none"> <li>• New functions added:</li> <li>• GUI_DrawStreamedBitmapAuto()</li> <li>• GUI_DrawStreamedBitmapExAuto()</li> <li>• GUI_DrawStreamedBitmap24Ex()</li> <li>• GUI_DrawStreamedBitmap555Ex()</li> <li>• GUI_DrawStreamedBitmap565Ex()</li> <li>• GUI_DrawStreamedBitmapM555Ex()</li> <li>• GUI_DrawStreamedBitmapM565Ex()</li> </ul> <p>Chapter <i>Font Converter</i> updated.</p> <ul style="list-style-type: none"> <li>• Functions to size, shift and move characters added.</li> </ul> <p>Chapter <i>Colors</i> updated.</p> <ul style="list-style-type: none"> <li>• Sub chapter 'Gamma correction' added.</li> </ul> <p>Chapter <i>The Window Manager (WM)</i> updated.</p> <ul style="list-style-type: none"> <li>• Change of the WM_MOVE message to transmit position changes.</li> <li>• New functions added:</li> <li>• WM_MOTION_Enable()</li> <li>• WM_MOTION_SetMovement()</li> <li>• WM_MOTION_SetDeceleration()</li> <li>• WM_MOTION_SetDefaultPeriod()</li> <li>• WM_MOTION_SetMotion()</li> <li>• WM_MOTION_SetMoveable()</li> <li>• WM_MOTION_SetSpeed()</li> </ul> <p>Chapter <i>Widgets (window objects)</i> updated.</p> <ul style="list-style-type: none"> <li>• New widget "SPINBOX" added.</li> <li>• New widget "IMAGE" added.</li> <li>• Return values added to the following functions:</li> <li>• BUTTON_SetText()</li> <li>• TEXT_SetText()</li> <li>• New function DROPDOWN_GetItemText() added.</li> <li>• New function EDIT_GetBkColor() added.</li> <li>• New function EDIT_SetBkColor() added.</li> <li>• New function EDIT_SetFocussable() added.</li> <li>• New function EDIT_GetFont() added.</li> <li>• New function GUI_EditFloat() added.</li> <li>• Listing of widget IDs added.</li> </ul> <p>Chapter <i>Sprites</i> updated.</p> <ul style="list-style-type: none"> <li>• New function GUI_SPRITE_CreateAnim() added.</li> <li>• New function GUI_SPRITE_CreateExAnim() added.</li> </ul> <p>Chapter <i>Cursors</i> updated.</p> <ul style="list-style-type: none"> <li>• New function GUI_CURSOR_SelectAnim() added.</li> </ul> <p>Chapter <i>Display drivers</i> updated.</p> <ul style="list-style-type: none"> <li>• New display controllers supported by GUIDRV_FlexColor:</li> <li>• 66708: FocalTech FT1509</li> <li>• 66709: Renesas R61526</li> <li>• 66709: Ilitek ILI9342</li> <li>• 66712: Himax HX8347</li> <li>• 66712: Himax HX8352</li> <li>• New display controllers supported by GUIDRV_CompactColor_16:</li> <li>• 66708: FocalTech FT1509</li> <li>• 66709: Renesas R61526</li> <li>• 66709: Ilitek ILI9342</li> </ul> |
| 5.12     | 1        | 111021 | AS       | <p>Font Converter documentation added as chapter 11.</p> <ul style="list-style-type: none"> <li>• New function GUIDRV_FlexColor_SetFunc66712() added.</li> <li>• New function GUIDRV_FlexColor_SetInterface66712B16() added.</li> <li>• New display controller supported by GUIDRV_07X1:</li> <li>• 741: Novatek NT7508</li> <li>• New display controller supported by GUIDRV_Page1bpp:</li> <li>• 1510: Solomon SSD1821</li> <li>• GUIDRV_Lin 'Using the Lin driver in systems with cache memory' changed.</li> </ul>  |



| Software | Revision | Date   | By       | Description  |
|----------|----------|--------|----------|--|
| 5.12     | 0        | 110621 | AS<br>JE | <p>Chapter <i>Widgets (window objects)</i> updated.</p> <ul style="list-style-type: none"> <li>• New function <code>LISTVIEW_SetHeaderHeight()</code> added.</li> <li>• New function <code>ICONVIEW_AddStreamedBitmapItem()</code> added.</li> <li>• New function <code>ICONVIEW_GetItemText()</code> added.</li> <li>• New function <code>ICONVIEW_GetItemUserData()</code> added.</li> <li>• New function <code>ICONVIEW_GetNumItems()</code> added.</li> <li>• New function <code>ICONVIEW_InsertBitmapItem()</code> added.</li> <li>• New function <code>ICONVIEW_InsertStreamedBitmapItem()</code> added.</li> <li>• New function <code>ICONVIEW_SetBitmapItem()</code> added.</li> <li>• New function <code>ICONVIEW_SetFrame()</code> added.</li> <li>• New function <code>ICONVIEW_SetItemText()</code> added.</li> <li>• New function <code>ICONVIEW_SetItemUserData()</code> added.</li> <li>• New function <code>ICONVIEW_SetSpace()</code> added.</li> <li>• New function <code>ICONVIEW_SetStreamedBitmapItem()</code> added.</li> <li>• New function <code>ICONVIEW_SetTextAlign()</code> added.</li> <li>• New function <code>TEXT_GetNumLines()</code> added.</li> </ul> <p>Chapter <i>Display drivers</i> updated.</p> <ul style="list-style-type: none"> <li>• New display drivers added: <ul style="list-style-type: none"> <li>• <code>GUIDRV_Dist</code></li> <li>• <code>GUIDRV_SPage</code></li> </ul> </li> <li>• New display controller supported by <code>GUIDRV_CompactColor_16</code>:</li> <li>• 66709: Solomon SSD1961</li> <li>• <code>LCD_SetDevFunc(): LCD_DEVFUNC_COPYRECT</code> added.</li> <li>• <code>GUIDRV_Lin: Support for LCD_DEVFUNC_COPYRECT</code> added.</li> </ul>  |
| 5.10     | 1        | 110531 | AS<br>JE | <p>Chapter <i>Display drivers</i> updated.</p> <ul style="list-style-type: none"> <li>• New display driver: <code>GUIDRV_FlexColor</code></li> </ul>   |
| 5.10     | 0        | 110329 | AS<br>JE | <p>Chapter <i>Memory Devices</i> updated.</p> <ul style="list-style-type: none"> <li>• Default for <code>GUI_USE_MEMDEV_1BPP_FOR_SCREEN</code> set to 1.</li> <li>• New function <code>GUI_MEMDEV_MarkDirty()</code> added.</li> </ul> <p>New chapter <i>GUI Builder</i> added.</p> <p>Chapter <i>Display drivers</i> updated.</p> <ul style="list-style-type: none"> <li>• New display controllers supported by <code>GUIDRV_CompactColor_16</code>:</li> <li>• 66708: Ilitek ILI9328</li> <li>• 66709: Sitronix ST7715</li> <li>• 66772: Ilitek ILI9221</li> <li>• New function <code>GUIDRV_BitPlains_Config()</code> added.</li> </ul>   |
| 5.08     | 0        | 110112 | AS<br>JE | <p>Chapter <i>2-D Graphic Library</i> updated.</p> <ul style="list-style-type: none"> <li>• New function <code>GUI_CreateBitmapFromStreamRLEAlpha()</code> added.</li> <li>• New function <code>GUI_CreateBitmapFromStreamRLE32()</code> added.</li> <li>• Function <code>GUI_CreateBitmapFromStream()</code> supports additional formats.</li> </ul> <p>Chapter <i>Bitmap Converter</i> updated.</p> <ul style="list-style-type: none"> <li>• New format 'Alpha channel, compressed' added.</li> <li>• New format 'True color with alpha channel, compressed' added.</li> <li>• New function 'Image/Convert Into/Best Palette + transparency' added.</li> </ul> <p>Chapter <i>Memory Devices</i> updated.</p> <ul style="list-style-type: none"> <li>• New functions <code>GUI_MEMDEV_SetAnimationCallback()</code> added.</li> <li>• New functions <code>GUI_MEMDEV_ShiftInWindow()</code> added.</li> <li>• New functions <code>GUI_MEMDEV_ShiftOutWindow()</code> added.</li> </ul> <p>Chapter <i>Execution Model: Single Task / Multitask</i> updated.</p> <ul style="list-style-type: none"> <li>• New function <code>GUI_SetSignalEventFunc()</code> added.</li> <li>• New function <code>GUI_SetWaitEventFunc()</code> added.</li> <li>• New function <code>GUI_SetWaitEventTimedFunc()</code> added.</li> <li>• Definitions of configuration macros changed.</li> </ul> <p>Chapter <i>The Window Manager (WM)</i> updated.</p> <ul style="list-style-type: none"> <li>• New function <code>WM_MULTIBUF_Enable()</code> added.</li> <li>• New messages <code>WM_PRE_PAINT</code> and <code>WM_POST_PAINT</code> added.</li> </ul> <p>Chapter <i>Widgets (window objects)</i> updated.</p> <ul style="list-style-type: none"> <li>• <code>LISTVIEW_SetUserData()</code> renamed in <code>LISTVIEW_SetUserDataRow()</code>.</li> <li>• <code>LISTVIEW_GetUserData()</code> renamed in <code>LISTVIEW_GetUserDataRow()</code>.</li> <li>• New function <code>&lt;WIDGET&gt;_SetUserData()</code> added for all widgets.</li> <li>• New function <code>&lt;WIDGET&gt;_GetUserData()</code> added for all widgets.</li> <li>• New function <code>&lt;WIDGET&gt;_CreateUser()</code> added for all widgets.</li> <li>• New function <code>BUTTON_GetTextAlign()</code> added.</li> <li>• New function <code>BUTTON_SetReactOnLevel()</code> added.</li> <li>• New function <code>ICONVIEW_CreateIndirect()</code> added.</li> <li>• New function <code>ICONVIEW_DeleteItem()</code> added.</li> <li>• New function <code>LISTWHEEL_CreateIndirect()</code> added.</li> <li>• New function <code>SCROLLBAR_SetThumbSizeMin()</code> added.</li> <li>• New function <code>SCROLLBAR_GetThumbSizeMin()</code> added.</li> <li>• New function <code>TREEVIEW_ITEM_CollapseAll()</code> added.</li> </ul> |

| Software | Revision | Date   | By | Description   |
|----------|----------|--------|----|---|
|          |          |        |    | <ul style="list-style-type: none"> <li>• New function TREEVIEW_ITEM_ExpandAll() added.</li> </ul> Chapter <i>Skinning</i> updated. <ul style="list-style-type: none"> <li>• New configuration macro WIDGET_USE_FLEX_SKIN added.</li> <li>• New message WIDGET_ITEM_GET_RADIUS added to frame window skin.</li> </ul> Chapter <i>Multiple Buffering</i> updated. <ul style="list-style-type: none"> <li>• New function GUI_MULTIBUF_Begin() added.</li> <li>• New function GUI_MULTIBUF_End() added.</li> <li>• New function GUI_MULTIBUF_Config() added.</li> </ul> Chapter <i>Language Support</i> <ul style="list-style-type: none"> <li>• New function GUI_UC_EnableBIDI() added.</li> </ul>   |
| 5.06     | 0        | 100907 | JE | Chapter <i>Fonts</i> updated. <ul style="list-style-type: none"> <li>• New function GUI_SetDefaultFont() added.</li> </ul> Chapter <i>Memory Devices</i> updated. <ul style="list-style-type: none"> <li>• New function GUI_MEMDEV_FadeDevices() added.</li> </ul> Chapter <i>Widgets (window objects)</i> updated. <ul style="list-style-type: none"> <li>• New function BUTTON_SetReactOnLevel() added.</li> <li>• New function GRAPH_DATA_XY_SetOwnerDraw() added.</li> <li>• New function LISTVIEW_SetItemBitmap() added.</li> <li>• New function LISTWHEEL_SetPos() added.</li> <li>• New function SCROLLBAR_GetNumItems() added.</li> <li>• New function SCROLLBAR_GetPageSize() added.</li> </ul> New Chapter <i>Skinning</i> added. <ul style="list-style-type: none"> <li>• Skinning for the most common widgets added.</li> </ul> Chapter <i>Display drivers</i> updated. <ul style="list-style-type: none"> <li>• New function GUI_SetOrientation() added.</li> <li>• New OXY-orientations for 16, 24 and 32 bpp added to GUIDRV_Lin.</li> </ul> |
| 5.04     | 2        | 100526 | AS | Chapter <i>Widgets (window objects)</i> updated. <ul style="list-style-type: none"> <li>• New function GRAPH_DATA_XY_SetOwnerDraw() added.</li> <li>• New function LISTVIEW_SetItemBitmap() added.</li> </ul> Chapter <i>Fonts</i> updated. <ul style="list-style-type: none"> <li>• New function GUI_SetDefaultFont() added.</li> </ul> Chapter <i>2-D Graphic Library</i> updated. <ul style="list-style-type: none"> <li>• New function GUI_GetPixelIndex() added.</li> </ul> Chapter <i>Execution Model: Single Task / Multitask</i> updated. <ul style="list-style-type: none"> <li>• GUITASK_SetMaxTask()</li> <li>• GUIDRV_CompactColor_16:</li> <li>• Support for the following display controllers added:               <ul style="list-style-type: none"> <li>• Himax HX8353</li> <li>• LGDP4551</li> <li>• Orisetech SPFD54124C</li> <li>• Renesas R61505</li> <li>• Sitronix ST7735, ST7787</li> <li>• Solomon SSD1284, SSD2119</li> </ul> </li> <li>• Added driver macros to each driver which uses them.</li> </ul>                           |
| 5.04     | 1        | 100505 | AS | New Drivers 'GUIDRV_S1D15G00' and 'GUIDRV_SLin' added.<br>Various corrections<br>Chapter <i>2-D Graphic Library</i> updated. <ul style="list-style-type: none"> <li>• New function GUI_DrawGradientRoundedV()</li> <li>• New function GUI_DrawGradientRoundedH()</li> <li>• New function GUI_DrawRoundedFrame()</li> </ul> Chapter <i>Memory Devices</i> updated. <ul style="list-style-type: none"> <li>• New function GUI_MEMDEV_MoveInWindow()</li> <li>• New function GUI_MEMDEV_MoveOutWindow()</li> <li>• New function GUI_MEMDEV_FadeInWindow()</li> <li>• New function GUI_MEMDEV_FadeOutWindow()</li> </ul> Chapter <i>Simulation</i> updated. <ul style="list-style-type: none"> <li>• New function SIM_GUI_SetCallback()</li> <li>• New function SIM_GUI_ShowDevice()</li> </ul>   |
| 5.04     | 0        | 100104 | JE | Chapter <i>Displaying Text</i> updated. <ul style="list-style-type: none"> <li>• New function GUI_DispStringInRectWrap() added.</li> <li>• New function GUI_WrapGetNumLines() added.</li> </ul> Chapter <i>2-D Graphic Library</i> updated. <ul style="list-style-type: none"> <li>• New function GUI_EnableAlpha() added.</li> <li>• New function GUI_RestoreUserAlpha() added.</li> <li>• New function GUI_SetUserAlpha() added.</li> <li>• New function GUI_CreateBitmapFromStream() added.</li> <li>• New function GUI_DrawStreamedBitmapEx() added.</li> <li>• New function GUI_GetStreamedBitmapInfo() added.</li> <li>• New function GUI_GetStreamedBitmapInfoEx() added.</li> <li>• New function GUI_SetStreamedBitmapHook() added.</li> <li>• New function GUI_CreateBitmapFromStreamIDX() added.</li> </ul>   |

| Software | Revision | Date   | By | Description   |
|----------|----------|--------|----|---|
|          |          |        |    | <ul style="list-style-type: none"> <li>• New function GUI_CreateBitmapFromStreamRLE4() added.</li> <li>• New function GUI_CreateBitmapFromStreamRLE8() added.</li> <li>• New function GUI_CreateBitmapFromStream565() added.</li> <li>• New function GUI_CreateBitmapFromStreamM565() added.</li> <li>• New function GUI_CreateBitmapFromStream555() added.</li> <li>• New function GUI_CreateBitmapFromStreamM555() added.</li> <li>• New function GUI_CreateBitmapFromStreamRLE16() added.</li> <li>• New function GUI_CreateBitmapFromStreamRLEM16() added.</li> <li>• New function GUI_CreateBitmapFromStream24() added.</li> <li>• New function GUI_CreateBitmapFromStreamAlpha() added.</li> </ul> <p>Chapter <i>Fonts</i> updated.</p> <ul style="list-style-type: none"> <li>• New font F20F_ASCII (framed) added.</li> <li>• New fonts F6x8_ASCII and F6x8_1 added.</li> <li>• New fonts F8x8_ASCII and F8x8_1 added.</li> <li>• New fonts F8x16_ASCII and F8x16_1 added.</li> <li>• Support for new font formats extended AA2 and extended AA4 added.</li> </ul> <p>Chapter <i>Memory Devices</i> updated.</p> <ul style="list-style-type: none"> <li>• Considerations for multiple layers/displays added.</li> </ul> <p>Chapter <i>The Window Manager (WM)</i> updated.</p> <ul style="list-style-type: none"> <li>• WM_DeleteWindow() now also deletes any associated timer.</li> </ul> <p>Chapter <i>Widgets (window objects)</i> updated.</p> <ul style="list-style-type: none"> <li>• New function WINDOW_SetBkColor() added.</li> </ul> <p>Chapter <i>Pointer Input Devices</i> updated.</p> <ul style="list-style-type: none"> <li>• PID buffer added.</li> <li>• Explanation of touch calibration revised.</li> </ul> <p>Chapter <i>Keyboard Input</i> updated.</p> <ul style="list-style-type: none"> <li>• Keyboard buffer added.</li> </ul> <p>Chapter <i>Display drivers</i> updated.</p> <ul style="list-style-type: none"> <li>• New driver GUIDRV_BitPlains added.</li> <li>• New driver GUIDRV_SLin added.</li> <li>• New driver GUIDRV_SSD1926 added.</li> <li>• Driver GUIDRV_1611 added.</li> <li>• Driver GUIDRV_6331 added.</li> <li>• Driver GUIDRV_7529 added.</li> <li>• Driver GUIDRV_Page1bpp added.</li> <li>• GUIDRV_CompactColor_16:</li> <li>• Support for the following display controllers added:</li> <li>• Himax HX8340, HX8352</li> <li>• Solomon SSD1298, SSD1355, SSD1963</li> <li>• Epson S1D19122</li> <li>• Orisetech SPFD5414D</li> <li>• Ilitek ILI9320, ILI9326</li> </ul> <p>Chapter <i>VNC Server</i> updated.</p> <ul style="list-style-type: none"> <li>• New function GUI_VNC_EnableKeyboardInput()</li> <li>• New function GUI_VNC_GetNumConnections()</li> <li>• New function GUI_VNC_SetPassword()</li> <li>• New function GUI_VNC_SetProgName()</li> <li>• New function GUI_VNC_SetSize()</li> <li>• New function GUI_VNC_RingBell()</li> </ul> |
| 5.00     | 1        | 090409 | JE | <p>Chapter <i>Simulation</i> updated.</p> <ul style="list-style-type: none"> <li>• Completely revised.</li> </ul> <p>Chapter <i>Displaying bitmap files</i> updated.</p> <ul style="list-style-type: none"> <li>• PNG support added.</li> </ul>   |
| 5.00     | 0        | 090409 | JE | <p>Software has been completely revised.<br/>For the version history of earlier versions, refer to older documents.</p>   |



# About this document

---

## Assumptions

This document assumes that you already have a solid knowledge of the following:

- The software tools used for building your application (assembler, linker, C compiler).
- The C programming language.
- The target processor.
- DOS command line.

If you feel that your knowledge of C is not sufficient, we recommend *C: A Reference Manual* by Harbison and Steele (ISBN 0--13--089592X). This book provides a complete description of the C language, the run-time libraries, and a style of C programming that emphasizes correctness, portability, and maintainability.

## How to use this manual

This manual explains all the functions and macros that the product offers. It assumes you have a working knowledge of the C language. Knowledge of assembly programming is not required.

## Typographic conventions for syntax

This manual uses the following typographic conventions:

| Style                   | Used for   |
|-------------------------|--|
| Body                    | Body text.   |
| Parameter               | Parameters in API functions.   |
| Sample                  | Sample code in program examples.   |
| Sample comment          | Comments in program examples.  |
| User Input              | Text entered at the keyboard by a user in a session transcript.  |
| Secret Input            | Text entered at the keyboard by a user, but not echoed (e.g. password entry), in a session transcript. |
| Reference               | Reference to chapters, sections, tables and figures.   |
| <b>Emphasis</b>         | Very important sections.   |
| <i>SEgger home page</i> | A hyperlink to an external document or web site.   |



# Table of contents

---

|           |  |     |
|-----------|--|-----|
| 1         | Introduction to emWin .....                                  | 71  |
| 1.1       | Purpose of this document .....                               | 72  |
| 1.2       | Requirements .....   | 73  |
| 1.2.1     | Target system (hardware) .....                               | 73  |
| 1.2.2     | Development environment (compiler) .....                     | 73  |
| 1.3       | Features .....   | 74  |
| 1.4       | Complete emWin system .....                                  | 76  |
| 1.5       | Examples and demos .....                                     | 77  |
| 1.6       | Starter kits .....   | 79  |
| 1.7       | AppWizard .....  | 80  |
| 1.8       | Screen and coordinates .....                                 | 81  |
| 1.9       | How to connect the display to the microcontroller .....      | 82  |
| 1.10      | Data types .....   | 83  |
| 2         | Getting Started .....  | 84  |
| 2.1       | Recommended project structure .....                          | 85  |
| 2.2       | Subdirectories .....   | 86  |
| 2.2.1     | Include directories .....                                    | 86  |
| 2.3       | Adding emWin to the target program .....                     | 87  |
| 2.4       | Creating a library .....                                     | 88  |
| 2.4.1     | Adapting the library batch files to a different system ..... | 89  |
| 2.5       | C files to include in the project .....                      | 92  |
| 2.6       | Configuring emWin .....                                      | 93  |
| 2.6.1     | Configuration macros .....                                   | 93  |
| 2.7       | Initializing emWin .....                                     | 94  |
| 2.7.1     | GUI_Init() .....   | 95  |
| 2.7.2     | GUI_IsInitialized() .....                                    | 96  |
| 2.7.3     | GUI_Exit() .....   | 97  |
| 2.8       | Using emWin with target hardware .....                       | 98  |
| 2.9       | The "Hello world" example program .....                      | 99  |
| 3         | Configuration .....  | 100 |
| 3.1       | What needs to be configured? .....                           | 101 |
| 3.2       | Run-time- and compile-time configuration .....               | 102 |
| 3.3       | Initialization process of emWin .....                        | 103 |
| 3.4       | Run-time configuration .....                                 | 104 |
| 3.4.1     | Customizing GUIConf.c .....                                  | 104 |
| 3.4.1.1   | API functions to be used in GUI_X_Config() .....             | 104 |
| 3.4.1.1.1 | GUI_ALLOC_AssignMemory() .....                               | 105 |

|           |  |     |
|-----------|--|-----|
| 3.4.1.1.2 | GUI_RegisterAfterInitHook()                  | 106 |
| 3.4.1.1.3 | GUI_SetOnErrorFunc()                         | 107 |
| 3.4.1.1.4 | GUI_SetOnLogFunc()                           | 108 |
| 3.4.1.1.5 | GUI_SetOnWarnFunc()                          | 109 |
| 3.4.1.1.6 | GUITASK_GetMaxTask()                         | 110 |
| 3.4.1.1.7 | GUITASK_SetMaxTask()                         | 111 |
| 3.4.2     | Customizing LCDConf.c                        | 112 |
| 3.4.2.1   | LCD_X_Config()                               | 113 |
| 3.4.2.2   | LCD_X_DisplayDriver()                        | 114 |
| 3.4.2.3   | API functions to be used in LCD_X_Config()   | 115 |
| 3.4.2.3.1 | GUI_DEVICE_CreateAndLink()                   | 116 |
| 3.4.3     | Customizing GUI_X.c                          | 117 |
| 3.4.3.1   | Init routines                                | 117 |
| 3.4.3.1.1 | GUI_X_Init()                                 | 117 |
| 3.4.3.2   | Timing routines                              | 118 |
| 3.4.3.2.1 | GUI_X_Delay()                                | 118 |
| 3.4.3.2.2 | GUI_X_ExecIdle()                             | 119 |
| 3.4.3.2.3 | GUI_X_GetTime()                              | 120 |
| 3.4.3.3   | Debug routines                               | 121 |
| 3.4.3.3.1 | GUI_X_ErrorOut()                             | 121 |
| 3.4.3.3.2 | GUI_X_Warn()                                 | 121 |
| 3.4.3.3.3 | GUI_X_Log()                                  | 121 |
| 3.4.3.4   | Kernel interface routines                    | 122 |
| 3.4.4     | Function replacement                         | 122 |
| 3.4.4.1   | GUI_SetpfMemcpy()                            | 123 |
| 3.4.4.2   | GUI_SetpfMemset()                            | 124 |
| 3.4.4.3   | GUI_SetpfStrcmp()                            | 125 |
| 3.4.4.4   | GUI_SetpfStrcpy()                            | 126 |
| 3.4.4.5   | GUI_SetpfStrlen()                            | 127 |
| 3.5       | Compile-time configuration                   | 128 |
| 3.5.1     | Customizing GUIConf.h                        | 128 |
| 3.5.1.1   | Configuring the available features of emWin  | 128 |
| 3.5.1.2   | Default font and default color configuration | 128 |
| 3.5.1.3   | Advanced GUI configuration options           | 129 |
| 3.5.1.3.1 | GUI_MEMCPY (obsolete)                        | 129 |
| 3.5.1.3.2 | GUI_MEMSET (obsolete)                        | 130 |
| 3.5.1.3.3 | GUI_POST_INIT                                | 130 |
| 3.5.1.3.4 | GUI_TRIAL_VERSION                            | 130 |
| 3.5.2     | Customizing LCDConf.h                        | 130 |
| 3.6       | Hardware acceleration                        | 131 |
| 3.6.1     | Ready to use configurations                  | 131 |
| 3.6.2     | Using D/AVE 2D hardware IP core              | 132 |
| 3.6.3     | Using ChromART accelerator                   | 132 |
| 3.6.4     | Available API functions                      | 132 |
| 3.6.5     | Color conversion                             | 134 |
| 3.6.5.1   | GUICC_M1555I_SetCustColorConv()              | 134 |
| 3.6.5.2   | GUICC_M565_SetCustColorConv()                | 134 |
| 3.6.5.3   | GUICC_M4444I_SetCustColorConv()              | 134 |
| 3.6.5.4   | GUICC_M888_SetCustColorConv()                | 134 |
| 3.6.5.5   | GUICC_M8888I_SetCustColorConv()              | 134 |
| 3.6.6     | Filling, copy operations and bitmap drawing  | 135 |
| 3.6.7     | Alpha blending                               | 136 |
| 3.6.7.1   | GUI_AlphaEnableFillRectHW()                  | 136 |
| 3.6.7.2   | GUI_SetFuncAlphaBlending()                   | 137 |
| 3.6.7.3   | GUI_SetFuncDrawAlpha()                       | 138 |
| 3.6.8     | Mixing colors                                | 139 |
| 3.6.8.1   | GUI_SetFuncMixColors()                       | 139 |
| 3.6.8.2   | GUI_SetFuncMixColorsBulk()                   | 140 |
| 3.6.9     | Alpha text drawing                           | 141 |
| 3.6.9.1   | GUI_AA_SetpfDrawCharAA4()                    | 141 |



|            |  |     |
|------------|--|-----|
| 3.6.10     | Palette conversion .....                                   | 142 |
| 3.6.10.1   | GUI_SetFuncGetpPalConvTable() .....                        | 142 |
| 3.6.11     | Drawing bitmaps within memory devices .....                | 143 |
| 3.6.11.1   | GUI_MEMDEV_SetDrawMemdev16bppFunc() .....                  | 143 |
| 3.6.12     | Drawing shapes .....                                       | 144 |
| 3.6.12.1   | GUI_SetFuncFillCircle() .....                              | 144 |
| 3.6.12.2   | GUI_SetFuncDrawCircle() .....                              | 145 |
| 3.6.12.3   | GUI_SetFuncFillRoundedRect() .....                         | 146 |
| 3.6.12.4   | GUI_SetFuncDrawRoundedRect() .....                         | 147 |
| 3.6.12.5   | GUI_SetFuncDrawLine() .....                                | 148 |
| 3.6.13     | Drawing anti-aliased shapes .....                          | 149 |
| 3.6.13.1   | GUI_AA_SetFuncFillCircle() .....                           | 149 |
| 3.6.13.2   | GUI_AA_SetFuncFillPolygon() .....                          | 150 |
| 3.6.13.3   | GUI_AA_SetFuncDrawCircle() .....                           | 151 |
| 3.6.13.4   | GUI_AA_SetFuncDrawLine() .....                             | 152 |
| 3.6.13.5   | GUI_AA_SetFuncDrawPolyOutline() .....                      | 153 |
| 3.6.13.6   | GUI_AA_SetFuncDrawArc() .....                              | 154 |
| 3.6.14     | JPEG decoding .....  | 155 |
| 3.6.14.1   | GUI_JPEG_SetpfDrawEx() .....                               | 156 |
| 3.6.14.1.1 | pfDrawEx() .....   | 156 |
| 3.7        | Framebuffer located in data cache area of CPU .....        | 157 |
| 3.7.1      | Requirements .....   | 157 |
| 3.7.2      | Using multiple buffers and a data cache .....              | 157 |
| 3.7.2.1    | How it works .....   | 157 |
| 3.7.2.2    | Animations and multiple buffering .....                    | 157 |
| 3.7.2.3    | Memory device animation functions .....                    | 158 |
| 3.7.3      | Available API functions .....                              | 158 |
| 3.7.3.1    | GUI_DCACHE_Clear() .....                                   | 159 |
| 3.7.3.2    | GUI_DCACHE_SetClearCacheHook() .....                       | 160 |
| 3.8        | Memory management .....                                    | 161 |
| 3.8.1      | Usage .....  | 161 |
| 3.8.2      | Block management .....                                     | 161 |
| 3.8.3      | Available API functions .....                              | 161 |
| 3.8.3.1    | GUI_ALLOC_GetMaxUsedBytes() .....                          | 162 |
| 3.8.3.2    | GUI_ALLOC_GetNumFreeBytes() .....                          | 163 |
| 3.8.3.3    | GUI_ALLOC_GetMemInfo() .....                               | 164 |
| 3.8.3.4    | GUI_ALLOC_GetNumUsedBytes() .....                          | 165 |
| 4          | Simulation .....   | 166 |
| 4.1        | Using the simulation .....                                 | 167 |
| 4.1.1      | Rotating and mirroring the screen .....                    | 167 |
| 4.1.2      | Using the simulation with the trial version of emWin ..... | 167 |
| 4.1.2.1    | Directory structure .....                                  | 167 |
| 4.1.2.2    | Visual C++ workspace .....                                 | 168 |
| 4.1.2.3    | Compiling the demo program .....                           | 168 |
| 4.1.2.4    | Compiling the samples .....                                | 168 |
| 4.1.3      | Using the simulation with the emWin source .....           | 169 |
| 4.1.3.1    | Directory structure .....                                  | 169 |
| 4.1.3.2    | Visual C++ workspace .....                                 | 170 |
| 4.1.3.3    | Compiling the application .....                            | 170 |
| 4.1.4      | Advanced features of the simulation .....                  | 171 |
| 4.1.4.1    | Pause and Resume .....                                     | 171 |
| 4.1.4.2    | View system info .....                                     | 171 |
| 4.1.4.3    | Copy to clipboard .....                                    | 171 |
| 4.2        | Device simulation .....                                    | 172 |
| 4.2.1      | Generated frame view .....                                 | 172 |
| 4.2.2      | Custom bitmap view .....                                   | 173 |
| 4.2.3      | Window view .....  | 174 |
| 4.3        | Device simulation API .....                                | 175 |

|           |  |     |
|-----------|--|-----|
| 4.3.1     | Functions .....  | 177 |
| 4.3.1.1   | SIM_GUI_Delay() .....  | 177 |
| 4.3.1.2   | SIM_GUI_EnableModifierKey() .....                                  | 178 |
| 4.3.1.3   | SIM_GUI_ExecIdle() .....   | 179 |
| 4.3.1.4   | SIM_GUI_GetCompositeTouch() .....                                  | 180 |
| 4.3.1.5   | SIM_GUI_GetTime() .....  | 181 |
| 4.3.1.6   | SIM_GUI_IsModifierKeyEnabled() .....                               | 182 |
| 4.3.1.7   | SIM_GUI_SaveBMP() .....  | 183 |
| 4.3.1.8   | SIM_GUI_SaveBMPEx() .....  | 184 |
| 4.3.1.9   | SIM_GUI_SaveCompositeBMP() .....                                   | 185 |
| 4.3.1.10  | SIM_GUI_SetCallback() .....  | 186 |
| 4.3.1.11  | SIM_GUI_SetCompositeColor() .....                                  | 187 |
| 4.3.1.12  | SIM_GUI_SetCompositeSize() .....                                   | 188 |
| 4.3.1.13  | SIM_GUI_SetCompositeTouch() .....                                  | 189 |
| 4.3.1.14  | SIM_GUI_SetLCDColorBlack() .....                                   | 190 |
| 4.3.1.15  | SIM_GUI_SetLCDColorWhite() .....                                   | 190 |
| 4.3.1.16  | SIM_GUI_SetLCDPos() .....  | 192 |
| 4.3.1.17  | SIM_GUI_SetMag() .....   | 193 |
| 4.3.1.18  | SIM_GUI_SetTransColor() .....                                      | 194 |
| 4.3.1.19  | SIM_GUI_SetTransMode() .....                                       | 195 |
| 4.3.1.20  | SIM_GUI_ShowDevice() .....   | 196 |
| 4.3.1.21  | SIM_GUI_UseCustomBitmaps() .....                                   | 197 |
| 4.3.2     | Data structures .....  | 198 |
| 4.3.2.1   | SIM_GUI_INFO .....   | 198 |
| 4.3.3     | Defines .....  | 199 |
| 4.3.3.1   | Transparency modes .....   | 199 |
| 4.4       | Hardkey simulation .....   | 200 |
| 4.4.1     | Hardkey simulation API .....                                       | 200 |
| 4.4.1.1   | SIM_HARDKEY_GetNum() .....   | 201 |
| 4.4.1.2   | SIM_HARDKEY_GetState() .....                                       | 202 |
| 4.4.1.3   | SIM_HARDKEY_SetCallback() .....                                    | 203 |
| 4.4.1.4   | SIM_HARDKEY_SetMode() .....  | 204 |
| 4.4.1.5   | SIM_HARDKEY_SetState() .....                                       | 205 |
| 4.5       | Integrating the emWin simulation into an existing simulation ..... | 206 |
| 4.5.1     | Directory structure .....  | 206 |
| 4.5.2     | Using the simulation library .....                                 | 206 |
| 4.5.2.1   | Modifying WinMain .....  | 206 |
| 4.5.2.2   | Example application .....  | 207 |
| 4.5.3     | Integration into the embOS Simulation .....                        | 208 |
| 4.5.3.1   | SIM_OS.c .....   | 208 |
| 4.5.3.2   | Target program (main) .....  | 209 |
| 4.5.4     | GUI simulation API .....   | 210 |
| 4.5.4.1   | SIM_GUI_CreateLCDInfoWindow() .....                                | 211 |
| 4.5.4.2   | SIM_GUI_CreateLCDWindow() .....                                    | 212 |
| 4.5.4.3   | SIM_GUI_Enable() .....   | 213 |
| 4.5.4.4   | SIM_GUI_Exit() .....   | 214 |
| 4.5.4.5   | SIM_GUI_Init() .....   | 215 |
| 4.5.4.6   | SIM_GUI_SetLCDWindowHook() .....                                   | 216 |
| 5         | Basic features .....   | 217 |
| 5.1       | Displaying Text .....  | 218 |
| 5.1.1     | Basic routines .....   | 218 |
| 5.1.2     | Drawing modes .....  | 219 |
| 5.1.3     | Position .....   | 221 |
| 5.1.4     | Text API .....   | 222 |
| 5.1.4.1   | Displaying text .....  | 224 |
| 5.1.4.1.1 | GUI_DispCEOL() .....   | 224 |
| 5.1.4.1.2 | GUI_DispChar() .....   | 225 |
| 5.1.4.1.3 | GUI_DispCharAt() .....   | 226 |

|            |                                  |     |
|------------|----------------------------------|-----|
| 5.1.4.1.4  | GUI_DispChars()                  | 227 |
| 5.1.4.1.5  | GUI_DispString()                 | 228 |
| 5.1.4.1.6  | GUI_DispStringAt()               | 229 |
| 5.1.4.1.7  | GUI_DispStringAtCEOL()           | 230 |
| 5.1.4.1.8  | GUI_DispStringHCenterAt()        | 231 |
| 5.1.4.1.9  | GUI_DispStringInRect()           | 232 |
| 5.1.4.1.10 | GUI_DispStringInRectEx()         | 233 |
| 5.1.4.1.11 | GUI_DispStringInRectWrap()       | 234 |
| 5.1.4.1.12 | GUI_DispStringInRectWrapEx()     | 235 |
| 5.1.4.1.13 | GUI_DispStringLen()              | 236 |
| 5.1.4.1.14 | GUI_GetCharFromPos()             | 237 |
| 5.1.4.1.15 | GUI_GetShowMissingCharacters()   | 238 |
| 5.1.4.1.16 | GUI_ShowMissingCharacters()      | 239 |
| 5.1.4.1.17 | GUI_WrapGetNumLines()            | 240 |
| 5.1.4.2    | Drawing modes                    | 241 |
| 5.1.4.2.1  | GUI_GetTextMode()                | 241 |
| 5.1.4.2.2  | GUI_SetClearTextRectMode()       | 242 |
| 5.1.4.2.3  | GUI_SetTextMode()                | 243 |
| 5.1.4.2.4  | GUI_SetTextStyle()               | 244 |
| 5.1.4.3    | Alignment                        | 245 |
| 5.1.4.3.1  | GUI_GetTextAlign()               | 245 |
| 5.1.4.3.2  | GUI_SetLBorder()                 | 246 |
| 5.1.4.3.3  | GUI_SetTextAlign()               | 247 |
| 5.1.4.4    | Position                         | 248 |
| 5.1.4.4.1  | GUI_DispNextLine()               | 248 |
| 5.1.4.4.2  | GUI_GotoXY()                     | 249 |
| 5.1.4.4.3  | GUI_GotoX()                      | 249 |
| 5.1.4.4.4  | GUI_GotoY()                      | 249 |
| 5.1.4.4.5  | GUI_GetDispPosX()                | 250 |
| 5.1.4.4.6  | GUI_GetDispPosY()                | 251 |
| 5.1.4.5    | Defines                          | 252 |
| 5.1.4.5.1  | Text alignment flags             | 252 |
| 5.1.4.5.2  | Text drawing modes               | 253 |
| 5.1.4.5.3  | Text rotation modes              | 254 |
| 5.1.4.5.4  | Text style flags                 | 255 |
| 5.1.4.6    | Enumerations                     | 256 |
| 5.1.4.6.1  | GUI_WRAPMODE                     | 256 |
| 5.2        | Displaying Values                | 257 |
| 5.2.1      | Value API                        | 258 |
| 5.2.1.1    | Displaying decimal values        | 259 |
| 5.2.1.1.1  | GUI_DispDec()                    | 259 |
| 5.2.1.1.2  | GUI_DispDecAt()                  | 260 |
| 5.2.1.1.3  | GUI_DispDecMin()                 | 261 |
| 5.2.1.1.4  | GUI_DispDecShift()               | 262 |
| 5.2.1.1.5  | GUI_DispDecSpace()               | 263 |
| 5.2.1.1.6  | GUI_DispSDec()                   | 264 |
| 5.2.1.1.7  | GUI_DispSDecShift()              | 265 |
| 5.2.1.2    | Displaying floating point values | 266 |
| 5.2.1.2.1  | GUI_DispFloat()                  | 266 |
| 5.2.1.2.2  | GUI_DispFloatFix()               | 268 |
| 5.2.1.2.3  | GUI_DispFloatMin()               | 269 |
| 5.2.1.2.4  | GUI_DispSFloatFix()              | 270 |
| 5.2.1.2.5  | GUI_DispSFloatMin()              | 271 |
| 5.2.1.3    | Displaying binary values         | 272 |
| 5.2.1.3.1  | GUI_DispBin()                    | 272 |
| 5.2.1.3.2  | GUI_DispBinAt()                  | 273 |
| 5.2.1.4    | Displaying hexadecimal values    | 274 |
| 5.2.1.4.1  | GUI_DispHex()                    | 274 |
| 5.2.1.4.2  | GUI_DispHexAt()                  | 275 |
| 5.2.1.5    | GUI_GetVersionString()           | 276 |

|            |  |     |
|------------|--|-----|
| 5.3        | 2-D Graphic Library .....              | 277 |
| 5.3.1      | Graphic API .....                      | 277 |
| 5.3.1.1    | Drawing related functions .....        | 284 |
| 5.3.1.1.1  | GUI_AddRect() .....                    | 284 |
| 5.3.1.1.2  | GUI_GetClientRect() .....              | 285 |
| 5.3.1.1.3  | GUI_GetClipRect() .....                | 286 |
| 5.3.1.1.4  | GUI_GetDrawMode() .....                | 287 |
| 5.3.1.1.5  | GUI_GetPenSize() .....                 | 288 |
| 5.3.1.1.6  | GUI_GetPixelIndex() .....              | 289 |
| 5.3.1.1.7  | GUI_SetClipRect() .....                | 290 |
| 5.3.1.1.8  | GUI_SetDrawMode() .....                | 291 |
| 5.3.1.1.9  | GUI_SetPenSize() .....                 | 292 |
| 5.3.1.2    | Basic drawing routines .....           | 293 |
| 5.3.1.2.1  | GUI_Clear() .....                      | 293 |
| 5.3.1.2.2  | GUI_ClearRect() .....                  | 294 |
| 5.3.1.2.3  | GUI_CopyRect() .....                   | 295 |
| 5.3.1.2.4  | GUI_DrawFrame() .....                  | 296 |
| 5.3.1.2.5  | GUI_DrawFrameEx() .....                | 297 |
| 5.3.1.2.6  | GUI_DrawGradientH() .....              | 298 |
| 5.3.1.2.7  | GUI_DrawGradientHEx() .....            | 299 |
| 5.3.1.2.8  | GUI_DrawGradientV() .....              | 300 |
| 5.3.1.2.9  | GUI_DrawGradientVEx() .....            | 301 |
| 5.3.1.2.10 | GUI_DrawGradientRoundedH() .....       | 302 |
| 5.3.1.2.11 | GUI_DrawGradientRoundedHEx() .....     | 303 |
| 5.3.1.2.12 | GUI_DrawGradientRoundedV() .....       | 304 |
| 5.3.1.2.13 | GUI_DrawGradientRoundedVEx() .....     | 305 |
| 5.3.1.2.14 | GUI_DrawGradientMH() .....             | 306 |
| 5.3.1.2.15 | GUI_DrawGradientMV() .....             | 306 |
| 5.3.1.2.16 | GUI_DrawGradientMHEx() .....           | 307 |
| 5.3.1.2.17 | GUI_DrawGradientMVEx() .....           | 307 |
| 5.3.1.2.18 | GUI_DrawPixel() .....                  | 308 |
| 5.3.1.2.19 | GUI_DrawPoint() .....                  | 309 |
| 5.3.1.2.20 | GUI_DrawRect() .....                   | 310 |
| 5.3.1.2.21 | GUI_DrawRectEx() .....                 | 311 |
| 5.3.1.2.22 | GUI_DrawRoundedFrame() .....           | 312 |
| 5.3.1.2.23 | GUI_DrawRoundedFrameEx() .....         | 313 |
| 5.3.1.2.24 | GUI_DrawRoundedRect() .....            | 314 |
| 5.3.1.2.25 | GUI_DrawRoundedRectEx() .....          | 315 |
| 5.3.1.2.26 | GUI_FillRect() .....                   | 316 |
| 5.3.1.2.27 | GUI_FillRectEx() .....                 | 317 |
| 5.3.1.2.28 | GUI_FillRoundedRect() .....            | 318 |
| 5.3.1.2.29 | GUI_FillRoundedRectEx() .....          | 319 |
| 5.3.1.2.30 | GUI_InvertRect() .....                 | 320 |
| 5.3.1.3    | Alpha blending .....                   | 321 |
| 5.3.1.3.1  | GUI_EnableAlpha() .....                | 322 |
| 5.3.1.3.2  | GUI_PreserveTrans() .....              | 323 |
| 5.3.1.3.3  | GUI_RestoreUserAlpha() .....           | 324 |
| 5.3.1.3.4  | GUI_SetAlpha() .....                   | 325 |
| 5.3.1.3.5  | GUI_SetUserAlpha() .....               | 326 |
| 5.3.1.4    | Drawing bitmaps .....                  | 327 |
| 5.3.1.4.1  | GUI_DrawBitmap() .....                 | 327 |
| 5.3.1.4.2  | GUI_DrawBitmapEx() .....               | 328 |
| 5.3.1.4.3  | GUI_DrawBitmapMag() .....              | 329 |
| 5.3.1.4.4  | GUI_SetAlphaMask8888() .....           | 330 |
| 5.3.1.5    | Drawing streamed bitmaps .....         | 331 |
| 5.3.1.5.1  | GUI_CreateBitmapFromStream() .....     | 333 |
| 5.3.1.5.2  | GUI_CreateBitmapFromStreamIDX() .....  | 334 |
| 5.3.1.5.3  | GUI_CreateBitmapFromStreamRLE1() ..... | 334 |
| 5.3.1.5.4  | GUI_CreateBitmapFromStreamRLE4() ..... | 334 |
| 5.3.1.5.5  | GUI_CreateBitmapFromStreamRLE8() ..... | 334 |

|            |                                       |     |
|------------|---------------------------------------|-----|
| 5.3.1.5.6  | GUI_CreateBitmapFromStream444_12()    | 334 |
| 5.3.1.5.7  | GUI_CreateBitmapFromStream444_12_1()  | 334 |
| 5.3.1.5.8  | GUI_CreateBitmapFromStreamM444_12()   | 334 |
| 5.3.1.5.9  | GUI_CreateBitmapFromStreamM444_12_1() | 334 |
| 5.3.1.5.10 | GUI_CreateBitmapFromStream444_16()    | 334 |
| 5.3.1.5.11 | GUI_CreateBitmapFromStreamM444_16()   | 334 |
| 5.3.1.5.12 | GUI_CreateBitmapFromStreamA555()      | 334 |
| 5.3.1.5.13 | GUI_CreateBitmapFromStreamAM555()     | 334 |
| 5.3.1.5.14 | GUI_CreateBitmapFromStreamA565()      | 334 |
| 5.3.1.5.15 | GUI_CreateBitmapFromStreamAM565()     | 334 |
| 5.3.1.5.16 | GUI_CreateBitmapFromStream565()       | 334 |
| 5.3.1.5.17 | GUI_CreateBitmapFromStreamM565()      | 334 |
| 5.3.1.5.18 | GUI_CreateBitmapFromStream555()       | 334 |
| 5.3.1.5.19 | GUI_CreateBitmapFromStreamM555()      | 334 |
| 5.3.1.5.20 | GUI_CreateBitmapFromStreamRLE16()     | 334 |
| 5.3.1.5.21 | GUI_CreateBitmapFromStreamRLEM16()    | 334 |
| 5.3.1.5.22 | GUI_CreateBitmapFromStream24()        | 334 |
| 5.3.1.5.23 | GUI_CreateBitmapFromStreamAlpha()     | 334 |
| 5.3.1.5.24 | GUI_CreateBitmapFromStreamRLEAlpha()  | 334 |
| 5.3.1.5.25 | GUI_CreateBitmapFromStreamRLE32()     | 334 |
| 5.3.1.5.26 | GUI_DrawStreamedBitmap()              | 337 |
| 5.3.1.5.27 | GUI_DrawStreamedBitmapAuto()          | 338 |
| 5.3.1.5.28 | GUI_DrawStreamedBitmapEx()            | 339 |
| 5.3.1.5.29 | GUI_DrawStreamedBitmapExAuto()        | 340 |
| 5.3.1.5.30 | GUI_DrawStreamedBitmapA555Ex()        | 341 |
| 5.3.1.5.31 | GUI_DrawStreamedBitmapAM555Ex()       | 341 |
| 5.3.1.5.32 | GUI_DrawStreamedBitmapA565Ex()        | 341 |
| 5.3.1.5.33 | GUI_DrawStreamedBitmapAM565Ex()       | 341 |
| 5.3.1.5.34 | GUI_DrawStreamedBitmap555Ex()         | 341 |
| 5.3.1.5.35 | GUI_DrawStreamedBitmapM555Ex()        | 341 |
| 5.3.1.5.36 | GUI_DrawStreamedBitmap565Ex()         | 341 |
| 5.3.1.5.37 | GUI_DrawStreamedBitmapM565Ex()        | 341 |
| 5.3.1.5.38 | GUI_DrawStreamedBitmap24Ex()          | 341 |
| 5.3.1.5.39 | GUI_GetStreamedBitmapInfo()           | 342 |
| 5.3.1.5.40 | GUI_GetStreamedBitmapInfoEx()         | 343 |
| 5.3.1.5.41 | GUI_SetStreamedBitmapHook()           | 344 |
| 5.3.1.6    | Drawing lines                         | 345 |
| 5.3.1.6.1  | GUI_DrawHLine()                       | 346 |
| 5.3.1.6.2  | GUI_DrawLine()                        | 347 |
| 5.3.1.6.3  | GUI_DrawLineRel()                     | 348 |
| 5.3.1.6.4  | GUI_DrawLineTo()                      | 349 |
| 5.3.1.6.5  | GUI_DrawPolyLine()                    | 350 |
| 5.3.1.6.6  | GUI_DrawVLine()                       | 351 |
| 5.3.1.6.7  | GUI_GetLineStyle()                    | 352 |
| 5.3.1.6.8  | GUI_MoveRel()                         | 353 |
| 5.3.1.6.9  | GUI_MoveTo()                          | 354 |
| 5.3.1.6.10 | GUI_SetLineStyle()                    | 355 |
| 5.3.1.7    | Drawing polygons                      | 356 |
| 5.3.1.7.1  | GUI_DrawPolygon()                     | 356 |
| 5.3.1.7.2  | GUI_EnlargePolygon()                  | 357 |
| 5.3.1.7.3  | GUI_FillPolygon()                     | 358 |
| 5.3.1.7.4  | GUI_MagnifyPolygon()                  | 359 |
| 5.3.1.7.5  | GUI_RotatePolygon()                   | 361 |
| 5.3.1.8    | Drawing circles                       | 363 |
| 5.3.1.8.1  | GUI_DrawCircle()                      | 363 |
| 5.3.1.8.2  | GUI_FillCircle()                      | 364 |
| 5.3.1.9    | Drawing ellipses                      | 365 |
| 5.3.1.9.1  | GUI_DrawEllipse()                     | 365 |
| 5.3.1.9.2  | GUI_DrawEllipseXL()                   | 366 |
| 5.3.1.9.3  | GUI_FillEllipse()                     | 367 |

|            |  |     |
|------------|--|-----|
| 5.3.1.10   | Drawing arcs .....                         | 368 |
| 5.3.1.10.1 | GUI_DrawArc() .....                        | 368 |
| 5.3.1.10.2 | GUI_DrawArcHR() .....                      | 370 |
| 5.3.1.10.3 | GUI_DrawArcHREx() .....                    | 371 |
| 5.3.1.11   | Drawing graphs .....                       | 372 |
| 5.3.1.11.1 | GUI_DrawGraph() .....                      | 372 |
| 5.3.1.12   | Drawing barcodes .....                     | 373 |
| 5.3.1.12.1 | GUI_BARCODE_Draw() .....                   | 373 |
| 5.3.1.12.2 | GUI_BARCODE_GetXSize() .....               | 375 |
| 5.3.1.13   | Drawing QR codes .....                     | 376 |
| 5.3.1.13.1 | Memory requirement .....                   | 376 |
| 5.3.1.13.2 | GUI_QR_Create() .....                      | 377 |
| 5.3.1.13.3 | GUI_QR_CreateFramed() .....                | 378 |
| 5.3.1.13.4 | GUI_QR_Delete() .....                      | 379 |
| 5.3.1.13.5 | GUI_QR_Draw() .....                        | 380 |
| 5.3.1.13.6 | GUI_QR_GetInfo() .....                     | 381 |
| 5.3.1.14   | Drawing pie charts .....                   | 382 |
| 5.3.1.14.1 | GUI_DrawPie() .....                        | 382 |
| 5.3.1.14.2 | GUI_DrawPieHR() .....                      | 383 |
| 5.3.1.15   | Drawing splines .....                      | 384 |
| 5.3.1.15.1 | GUI_SPLINE_Create() .....                  | 384 |
| 5.3.1.15.2 | GUI_SPLINE_Delete() .....                  | 385 |
| 5.3.1.15.3 | GUI_SPLINE_Draw() .....                    | 386 |
| 5.3.1.15.4 | GUI_SPLINE_DrawAA() .....                  | 387 |
| 5.3.1.15.5 | GUI_SPLINE_GetY() .....                    | 388 |
| 5.3.1.15.6 | GUI_SPLINE_GetXSize() .....                | 389 |
| 5.3.1.16   | Saving and restoring the GUI context ..... | 390 |
| 5.3.1.16.1 | GUI_RestoreContext() .....                 | 390 |
| 5.3.1.16.2 | GUI_SaveContext() .....                    | 391 |
| 5.3.1.17   | Info about screen changes .....            | 392 |
| 5.3.1.17.1 | GUI_DIRTYDEVICE_Create() .....             | 392 |
| 5.3.1.17.2 | GUI_DIRTYDEVICE_CreateEx() .....           | 393 |
| 5.3.1.17.3 | GUI_DIRTYDEVICE_Delete() .....             | 394 |
| 5.3.1.17.4 | GUI_DIRTYDEVICE_DeleteEx() .....           | 395 |
| 5.3.1.17.5 | GUI_DIRTYDEVICE_Fetch() .....              | 396 |
| 5.3.1.17.6 | GUI_DIRTYDEVICE_FetchEx() .....            | 397 |
| 5.3.1.18   | YUV device .....                           | 398 |
| 5.3.1.18.1 | GUI_YUV_Create() .....                     | 398 |
| 5.3.1.18.2 | GUI_YUV_CreateEx() .....                   | 399 |
| 5.3.1.18.3 | GUI_YUV_Delete() .....                     | 400 |
| 5.3.1.18.4 | GUI_YUV_DeleteEx() .....                   | 401 |
| 5.3.1.18.5 | GUI_YUV_GetpData() .....                   | 402 |
| 5.3.1.18.6 | GUI_YUV_GetpDataEx() .....                 | 403 |
| 5.3.1.18.7 | GUI_YUV_InvalidateArea() .....             | 404 |
| 5.3.1.18.8 | GUI_YUV_SetPeriod() .....                  | 405 |
| 5.3.1.18.9 | GUI_YUV_SetPeriodEx() .....                | 406 |
| 5.3.1.19   | Cache with color reducer .....             | 407 |
| 5.3.1.19.1 | GUI_GCACHE_4_Create() .....                | 407 |
| 5.3.1.19.2 | GUI_GCACHE_4_CreateEx() .....              | 408 |
| 5.3.1.20   | Setting hook functions .....               | 409 |
| 5.3.1.20.1 | GUI_SetAfterExitHook() .....               | 409 |
| 5.3.1.20.2 | GUI_SetAfterInitHook() .....               | 410 |
| 5.3.1.20.3 | GUI_SetControlHook() .....                 | 411 |
| 5.3.1.20.4 | GUI_SetRefreshHook() .....                 | 412 |
| 5.3.1.21   | Data structures .....                      | 413 |
| 5.3.1.21.1 | GUI_ALPHA_STATE .....                      | 413 |
| 5.3.1.21.2 | GUI_BITMAPSTREAM_INFO .....                | 414 |
| 5.3.1.21.3 | GUI_BITMAPSTREAM_PARAM .....               | 415 |
| 5.3.1.21.4 | GUI_DIRTYDEVICE_INFO .....                 | 416 |
| 5.3.1.21.5 | GUI_GRADIENT_INFO .....                    | 417 |

|     |                               |   |     |
|-----|-------------------------------|---|-----|
|     | 5.3.1.21.6                    | GUI_POINT .....                                 | 418 |
|     | 5.3.1.21.7                    | GUI_QR_INFO .....                               | 419 |
|     | 5.3.1.21.8                    | GUI_RECT .....                                  | 420 |
|     | 5.3.1.22                      | Defines .....                                   | 421 |
|     | 5.3.1.22.1                    | Barcode types .....                             | 421 |
|     | 5.3.1.22.2                    | Drawing modes .....                             | 422 |
|     | 5.3.1.22.3                    | ECC levels for QR codes .....                   | 423 |
|     | 5.3.1.22.4                    | Line styles .....                               | 424 |
| 5.4 | Displaying bitmap files ..... |   | 425 |
|     | 5.4.1                         | BMP file support .....                          | 426 |
|     | 5.4.1.1                       | Supported formats .....                         | 426 |
|     | 5.4.1.2                       | BMP API .....                                   | 426 |
|     | 5.4.1.2.1                     | GUI_BMP_Draw() .....                            | 427 |
|     | 5.4.1.2.2                     | GUI_BMP_DrawEx() .....                          | 428 |
|     | 5.4.1.2.3                     | GUI_BMP_DrawScaled() .....                      | 429 |
|     | 5.4.1.2.4                     | GUI_BMP_DrawScaledEx() .....                    | 430 |
|     | 5.4.1.2.5                     | GUI_BMP_EnableAlpha() .....                     | 431 |
|     | 5.4.1.2.6                     | GUI_BMP_GetXSize() .....                        | 432 |
|     | 5.4.1.2.7                     | GUI_BMP_GetXSizeEx() .....                      | 433 |
|     | 5.4.1.2.8                     | GUI_BMP_GetYSize() .....                        | 434 |
|     | 5.4.1.2.9                     | GUI_BMP_GetYSizeEx() .....                      | 435 |
|     | 5.4.1.2.10                    | GUI_BMP_Serialize() .....                       | 436 |
|     | 5.4.1.2.11                    | GUI_BMP_SerializeEx() .....                     | 437 |
|     | 5.4.1.2.12                    | GUI_BMP_SerializeExBpp() .....                  | 438 |
|     | 5.4.2                         | JPEG file support .....                         | 439 |
|     | 5.4.2.1                       | Supported JPEG compression methods .....        | 439 |
|     | 5.4.2.2                       | Limitations .....                               | 439 |
|     | 5.4.2.3                       | Converting a JPEG file to C source .....        | 439 |
|     | 5.4.2.4                       | Displaying JPEG files .....                     | 439 |
|     | 5.4.2.5                       | Hardware support for decoding JPEG files .....  | 440 |
|     | 5.4.2.6                       | Memory usage .....                              | 440 |
|     | 5.4.2.7                       | Progressive JPEG files .....                    | 440 |
|     | 5.4.2.8                       | JPEG API .....                                  | 440 |
|     | 5.4.2.8.1                     | Functions .....                                 | 442 |
|     | 5.4.2.8.2                     | Data structures .....                           | 448 |
|     | 5.4.3                         | GIF file support .....                          | 449 |
|     | 5.4.3.1                       | Converting a GIF file to C source .....         | 449 |
|     | 5.4.3.2                       | Displaying GIF files .....                      | 449 |
|     | 5.4.3.3                       | Memory usage .....                              | 449 |
|     | 5.4.3.4                       | GIF API .....                                   | 449 |
|     | 5.4.3.4.1                     | Functions .....                                 | 451 |
|     | 5.4.3.4.2                     | Data structures .....                           | 467 |
|     | 5.4.4                         | PNG file support .....                          | 469 |
|     | 5.4.4.1                       | Converting a PNG file to C source .....         | 469 |
|     | 5.4.4.2                       | Displaying PNG files .....                      | 469 |
|     | 5.4.4.3                       | Memory usage .....                              | 469 |
|     | 5.4.4.4                       | PNG API .....                                   | 469 |
|     | 5.4.4.4.1                     | GUI_PNG_Draw() .....                            | 470 |
|     | 5.4.4.4.2                     | GUI_PNG_DrawEx() .....                          | 471 |
|     | 5.4.4.4.3                     | GUI_PNG_GetXSize() .....                        | 472 |
|     | 5.4.4.4.4                     | GUI_PNG_GetXSizeEx() .....                      | 473 |
|     | 5.4.4.4.5                     | GUI_PNG_GetYSize() .....                        | 474 |
|     | 5.4.4.4.6                     | GUI_PNG_GetYSizeEx() .....                      | 475 |
|     | 5.4.5                         | Getting data with the ...Ex() functions .....   | 476 |
| 5.5 | Colors .....                  |   | 478 |
|     | 5.5.1                         | Color management .....                          | 479 |
|     | 5.5.2                         | Logical colors .....                            | 480 |
|     | 5.5.3                         | Switching to ARGB .....                         | 481 |
|     | 5.5.3.1                       | Configuration .....                             | 481 |
|     | 5.5.3.2                       | Required changes in existing applications ..... | 481 |

|          |  |     |
|----------|--|-----|
| 5.5.3.3  | Configuring the BitmapConverter .....  | 482 |
| 5.5.4    | Predefined colors .....  | 483 |
| 5.5.5    | The color bar test routine .....   | 484 |
| 5.5.6    | Fixed palette modes .....  | 485 |
| 5.5.7    | Detailed fixed palette mode description .....  | 487 |
| 5.5.7.1  | GUICC_1: 1 bpp (black and white) .....   | 487 |
| 5.5.7.2  | GUICC_2: 2 bpp (4 grayscales) .....  | 487 |
| 5.5.7.3  | GUICC_4: 4 bpp (16 grayscales) .....   | 487 |
| 5.5.7.4  | GUICC_5: 5 bpp (32 grayscales) .....   | 487 |
| 5.5.7.5  | GUICC_111: 3 bpp (2 levels per color) .....  | 488 |
| 5.5.7.6  | GUICC_M111: 3 bpp (2 levels per color), red and blue swapped ..  | 488 |
| 5.5.7.7  | GUICC_16: 4 bpp (16 colors) .....  | 488 |
| 5.5.7.8  | GUICC_1616I: 8 bpp (16 colors + 4 bits alpha mask) .....   | 488 |
| 5.5.7.9  | GUICC_222: 6 bpp (4 levels per color) .....  | 489 |
| 5.5.7.10 | GUICC_M222: 6 bpp (4 levels per color), red and blue swapped<br>.....                                    | 489 |
| 5.5.7.11 | GUICC_8: 8 bpp (256 grayscales) .....  | 489 |
| 5.5.7.12 | GUICC_233: 8 bpp .....   | 490 |
| 5.5.7.13 | GUICC_M233: 8 bpp, red and blue swapped .....  | 490 |
| 5.5.7.14 | GUICC_323: 8 bpp .....   | 491 |
| 5.5.7.15 | GUICC_M323: 8 bpp, red and blue swapped .....  | 491 |
| 5.5.7.16 | GUICC_332: 8 bpp .....   | 492 |
| 5.5.7.17 | GUICC_M332: 8 bpp, red and blue swapped .....  | 492 |
| 5.5.7.18 | GUICC_444_12: .....  | 493 |
| 5.5.7.19 | GUICC_444_16: .....  | 493 |
| 5.5.7.20 | GUICC_M444_12: red and blue swapped .....  | 493 |
| 5.5.7.21 | GUICC_M444_16: red and blue swapped .....  | 493 |
| 5.5.7.22 | GUICC_M444_12_1: .....   | 494 |
| 5.5.7.23 | GUICC_M4444I: 12 bits colors + 4 bits alpha mask .....   | 494 |
| 5.5.7.24 | GUICC_555: 15 bpp .....  | 494 |
| 5.5.7.25 | GUICC_M555: 15 bpp, red and blue swapped .....   | 494 |
| 5.5.7.26 | GUICC_M1555I: 15 bits colors + 1 bit transparency .....  | 495 |
| 5.5.7.27 | GUICC_565: 16 bpp .....  | 495 |
| 5.5.7.28 | GUICC_M565: 16 bpp, red and blue swapped .....   | 495 |
| 5.5.7.29 | GUICC_666: 18 bpp .....  | 496 |
| 5.5.7.30 | GUICC_M666: 18 bpp, red and blue swapped .....   | 496 |
| 5.5.7.31 | GUICC_666_9: 18 bpp .....  | 496 |
| 5.5.7.32 | GUICC_M666_9: 18 bpp, red and blue swapped .....   | 496 |
| 5.5.7.33 | GUICC_666_18: 18 bpp .....   | 496 |
| 5.5.7.34 | GUICC_M666_18: 18 bpp, red and blue swapped .....  | 496 |
| 5.5.7.35 | GUICC_822216: 8 bpp, 2 levels per color + 8 grayscales + 16 levels<br>of alpha blending .....            | 496 |
| 5.5.7.36 | GUICC_84444: 8 bpp, 4 levels per color + 16 grayscales + 4(3)<br>levels of alpha blending .....          | 497 |
| 5.5.7.37 | GUICC_8666: 8bpp, 6 levels per color + 16 grayscales .....   | 497 |
| 5.5.7.38 | GUICC_8666_1: 8bpp, 6 levels per color + 16 grayscales +<br>transparency .....                           | 498 |
| 5.5.7.39 | GUICC_88666I: 16bpp - 8 bits color (6 levels per color + 16<br>grayscales) + 8 bits alpha blending ..... | 498 |
| 5.5.7.40 | GUICC_888: 24 bpp .....  | 499 |
| 5.5.7.41 | GUICC_M888: 24 bpp, red and blue swapped .....   | 499 |
| 5.5.7.42 | GUICC_8888: 32 bpp .....   | 499 |
| 5.5.7.43 | GUICC_8888I: 32 bpp .....  | 499 |
| 5.5.7.44 | GUICC_M8888: 32 bpp, red and blue swapped .....  | 500 |
| 5.5.7.45 | GUICC_M8888I: 32 bpp, red and blue swapped .....   | 500 |
| 5.5.7.46 | GUICC_0: Custom palette mode .....   | 500 |
| 5.5.7.47 | GUICC_1_2, GUICC_1_4, ... GUICC_1_24 .....   | 500 |
| 5.5.8    | Application defined color conversion .....   | 501 |
| 5.5.9    | Custom palette mode .....  | 502 |
| 5.5.9.1  | Look-up table API .....  | 502 |



|             |  |     |
|-------------|--|-----|
| 5.5.9.1.1   | LCD_SetLUT() .....                             | 503 |
| 5.5.9.1.2   | LCD_SetLUTEx() .....                           | 504 |
| 5.5.9.1.3   | LCD_SetLUTEntryEx() .....                      | 505 |
| 5.5.10      | Gamma correction .....                         | 506 |
| 5.5.11      | Color API .....                                | 506 |
| 5.5.11.1    | Basic functions .....                          | 507 |
| 5.5.11.1.1  | GUI_GetBkColor() .....                         | 507 |
| 5.5.11.1.2  | GUI_GetBkColorIndex() .....                    | 508 |
| 5.5.11.1.3  | GUI_GetColor() .....                           | 509 |
| 5.5.11.1.4  | GUI_GetColorIndex() .....                      | 510 |
| 5.5.11.1.5  | GUI_GetDefaultColor() .....                    | 511 |
| 5.5.11.1.6  | GUI_GetDefaultBkColor() .....                  | 512 |
| 5.5.11.1.7  | GUI_SetBkColor() .....                         | 513 |
| 5.5.11.1.8  | GUI_SetBkColorIndex() .....                    | 514 |
| 5.5.11.1.9  | GUI_SetColor() .....                           | 515 |
| 5.5.11.1.10 | GUI_SetColorIndex() .....                      | 516 |
| 5.5.11.1.11 | GUI_SetDefaultColor() .....                    | 517 |
| 5.5.11.1.12 | GUI_SetDefaultBkColor() .....                  | 518 |
| 5.5.11.2    | Conversion functions .....                     | 519 |
| 5.5.11.2.1  | GUI_CalcColorDist() .....                      | 519 |
| 5.5.11.2.2  | GUI_CalcVisColorError() .....                  | 520 |
| 5.5.11.2.3  | GUI_Color2Index() .....                        | 521 |
| 5.5.11.2.4  | GUI_Color2VisColor() .....                     | 522 |
| 5.5.11.2.5  | GUI_ColorIsAvailable() .....                   | 523 |
| 5.5.11.2.6  | GUI_Index2Color() .....                        | 524 |
| 5.6         | Fonts .....                                    | 525 |
| 5.6.1       | Introduction .....                             | 525 |
| 5.6.2       | Requirements .....                             | 525 |
| 5.6.3       | Font types .....                               | 526 |
| 5.6.4       | Font formats .....                             | 528 |
| 5.6.4.1     | C file format .....                            | 528 |
| 5.6.4.2     | System Independent Font (SIF) format .....     | 528 |
| 5.6.4.3     | External Bitmap Font (XBF) format .....        | 529 |
| 5.6.4.4     | iType and iTypeSpark font engine support ..... | 530 |
| 5.6.4.5     | TrueType Font (TTF) format .....               | 531 |
| 5.6.4.6     | Glyph Bitmap Distribution Format (BDF) .....   | 532 |
| 5.6.5       | Converting a TTF file to C source .....        | 533 |
| 5.6.6       | Declaring custom fonts .....                   | 533 |
| 5.6.7       | Selecting a font .....                         | 533 |
| 5.6.8       | Font API .....                                 | 534 |
| 5.6.8.1     | SIF file related font functions .....          | 537 |
| 5.6.8.1.1   | GUI_SIF_CreateFont() .....                     | 537 |
| 5.6.8.1.2   | GUI_SIF_DeleteFont() .....                     | 538 |
| 5.6.8.2     | TTF file related functions .....               | 539 |
| 5.6.8.2.1   | GUI_TTF_CreateFont() .....                     | 539 |
| 5.6.8.2.2   | GUI_TTF_CreateFontAA() .....                   | 541 |
| 5.6.8.2.3   | GUI_TTF_EmboldenFont() .....                   | 542 |
| 5.6.8.2.4   | GUI_TTF_EmboldenFontEx() .....                 | 543 |
| 5.6.8.2.5   | GUI_TTF_GetFamilyName() .....                  | 544 |
| 5.6.8.2.6   | GUI_TTF_GetStyleName() .....                   | 545 |
| 5.6.8.2.7   | GUI_TTF_ObliqueFont() .....                    | 546 |
| 5.6.8.2.8   | GUI_TTF_ObliqueFontEx() .....                  | 547 |
| 5.6.8.3     | XBF file related font functions .....          | 548 |
| 5.6.8.3.1   | GUI_XBF_CreateFont() .....                     | 548 |
| 5.6.8.3.2   | GUI_XBF_DeleteFont() .....                     | 550 |
| 5.6.8.4     | BDF file related font functions .....          | 551 |
| 5.6.8.4.1   | GUI_BDF_CreateFont() .....                     | 551 |
| 5.6.8.4.2   | GUI_BDF_DeleteFont() .....                     | 552 |
| 5.6.8.4.3   | GUI_BDF_EmboldenFont() .....                   | 553 |
| 5.6.8.4.4   | GUI_BDF_EmboldenFontEx() .....                 | 554 |

|            |  |     |
|------------|--|-----|
| 5.6.8.4.5  | GUI_BDF_GetFamilyName()                          | 555 |
| 5.6.8.4.6  | GUI_BDF_GetStyleName()                           | 556 |
| 5.6.8.4.7  | GUI_BDF_SetLetterSpacing()                       | 557 |
| 5.6.8.5    | FreeType related font functions                  | 558 |
| 5.6.8.5.1  | GUI_FT_DestroyCache()                            | 558 |
| 5.6.8.5.2  | GUI_FT_Done()                                    | 559 |
| 5.6.8.5.3  | GUI_FT_GetMeasurementChars()                     | 560 |
| 5.6.8.5.4  | GUI_FT_SetCacheSize()                            | 561 |
| 5.6.8.5.5  | GUI_FT_SetMeasurementChars()                     | 562 |
| 5.6.8.6    | Common font-related functions                    | 563 |
| 5.6.8.6.1  | GUI_GetCharDistX()                               | 563 |
| 5.6.8.6.2  | GUI_GetDefaultFont()                             | 564 |
| 5.6.8.6.3  | GUI_GetFallbackFont()                            | 565 |
| 5.6.8.6.4  | GUI_GetFont()                                    | 566 |
| 5.6.8.6.5  | GUI_GetFontDistY()                               | 567 |
| 5.6.8.6.6  | GUI_GetFontInfo()                                | 568 |
| 5.6.8.6.7  | GUI_GetFontSizeY()                               | 569 |
| 5.6.8.6.8  | GUI_GetLeadingBlankCols()                        | 570 |
| 5.6.8.6.9  | GUI_GetLeadingBlankRows()                        | 571 |
| 5.6.8.6.10 | GUI_GetStringDistX()                             | 572 |
| 5.6.8.6.11 | GUI_GetStringDistXEx()                           | 573 |
| 5.6.8.6.12 | GUI_GetTextExtend()                              | 574 |
| 5.6.8.6.13 | GUI_GetTrailingBlankCols()                       | 575 |
| 5.6.8.6.14 | GUI_GetTrailingBlankRows()                       | 576 |
| 5.6.8.6.15 | GUI_GetYDistOfFont()                             | 577 |
| 5.6.8.6.16 | GUI_GetYSizeOfFont()                             | 578 |
| 5.6.8.6.17 | GUI_IsInFont()                                   | 579 |
| 5.6.8.6.18 | GUI_SetDefaultFont()                             | 580 |
| 5.6.8.6.19 | GUI_SetFallbackFont()                            | 581 |
| 5.6.8.6.20 | GUI_SetFont()                                    | 582 |
| 5.6.8.6.21 | GUI_SetFuncGetFallbackFont()                     | 583 |
| 5.6.8.7    | Data structures                                  | 584 |
| 5.6.8.7.1  | GUI_FONTINFO                                     | 584 |
| 5.6.8.7.2  | GUI_TTF_CS                                       | 585 |
| 5.6.8.7.3  | GUI_TTF_DATA                                     | 586 |
| 5.6.8.8    | Defines  | 587 |
| 5.6.8.8.1  | Font info flags                                  | 587 |
| 5.6.8.8.2  | SIF font types                                   | 588 |
| 5.6.8.8.3  | XBF font types                                   | 589 |
| 5.6.9      | Character sets                                   | 590 |
| 5.6.9.1    | ASCII  | 590 |
| 5.6.9.2    | ISO 8859-1 Western Latin character set           | 590 |
| 5.6.9.3    | Unicode  | 592 |
| 5.6.10     | Standard fonts                                   | 593 |
| 5.6.10.1   | Font identifier naming convention                | 593 |
| 5.6.10.2   | Font file naming convention                      | 594 |
| 5.6.10.3   | Measurement, ROM-size and character set of fonts | 594 |
| 5.6.10.4   | Proportional fonts                               | 594 |
| 5.6.10.4.1 | Overview   | 594 |
| 5.6.10.4.2 | Font details                                     | 595 |
| 5.6.10.4.3 | Characters                                       | 597 |
| 5.6.10.5   | Proportional fonts, framed                       | 603 |
| 5.6.10.5.1 | Overview   | 603 |
| 5.6.10.5.2 | Font details                                     | 603 |
| 5.6.10.5.3 | Characters                                       | 603 |
| 5.6.10.6   | Monospaced fonts                                 | 603 |
| 5.6.10.6.1 | Overview   | 603 |
| 5.6.10.6.2 | Font details                                     | 604 |
| 5.6.10.6.3 | Characters                                       | 604 |
| 5.6.10.7   | Digit fonts (proportional)                       | 608 |

|            |  |     |
|------------|--|-----|
| 5.6.10.7.1 | Overview .....                                       | 608 |
| 5.6.10.7.2 | Font details .....                                   | 609 |
| 5.6.10.7.3 | Characters .....                                     | 609 |
| 5.6.10.8   | Digit fonts (monospaced) .....                       | 610 |
| 5.6.10.8.1 | Overview .....                                       | 610 |
| 5.6.10.8.2 | Font details .....                                   | 610 |
| 5.6.10.8.3 | Characters .....                                     | 611 |
| 5.7        | Animations .....                                     | 613 |
| 5.7.1      | Introduction .....                                   | 613 |
| 5.7.2      | Creating an animation object .....                   | 614 |
| 5.7.3      | Adding items to an animation .....                   | 614 |
| 5.7.4      | Position calculation .....                           | 615 |
| 5.7.4.1    | Custom defined position calculation .....            | 616 |
| 5.7.5      | Executing an animation .....                         | 617 |
| 5.7.5.1    | Using a slice callback function .....                | 617 |
| 5.7.5.2    | Animation item .....                                 | 617 |
| 5.7.5.3    | Using a delete callback function .....               | 618 |
| 5.7.6      | Animations API .....                                 | 619 |
| 5.7.6.1    | Functions .....                                      | 620 |
| 5.7.6.1.1  | GUI_ANIM_AddItem() .....                             | 620 |
| 5.7.6.1.2  | GUI_ANIM_AddItemById() .....                         | 621 |
| 5.7.6.1.3  | GUI_ANIM_Create() .....                              | 622 |
| 5.7.6.1.4  | GUI_ANIM_CreateWithId() .....                        | 623 |
| 5.7.6.1.5  | GUI_ANIM_Delete() .....                              | 624 |
| 5.7.6.1.6  | GUI_ANIM_DeleteAll() .....                           | 625 |
| 5.7.6.1.7  | GUI_ANIM_DeleteById() .....                          | 626 |
| 5.7.6.1.8  | GUI_ANIM_Exec() .....                                | 627 |
| 5.7.6.1.9  | GUI_ANIM_Get() .....                                 | 628 |
| 5.7.6.1.10 | GUI_ANIM_GetData() .....                             | 629 |
| 5.7.6.1.11 | GUI_ANIM_GetFirst() .....                            | 630 |
| 5.7.6.1.12 | GUI_ANIM_GetItemData() .....                         | 631 |
| 5.7.6.1.13 | GUI_ANIM_GetNext() .....                             | 632 |
| 5.7.6.1.14 | GUI_ANIM_GetNumItems() .....                         | 633 |
| 5.7.6.1.15 | GUI_ANIM_IsRunning() .....                           | 634 |
| 5.7.6.1.16 | GUI_ANIM_Start() .....                               | 635 |
| 5.7.6.1.17 | GUI_ANIM_StartEx() .....                             | 636 |
| 5.7.6.1.18 | GUI_ANIM_StartExId() .....                           | 637 |
| 5.7.6.1.19 | GUI_ANIM_Stop() .....                                | 638 |
| 5.7.6.1.20 | GUI_ANIM_StopById() .....                            | 639 |
| 5.7.6.2    | Data structures .....                                | 640 |
| 5.7.6.2.1  | GUI_ANIM_INFO .....                                  | 640 |
| 5.7.6.3    | Defines .....  | 641 |
| 5.7.6.3.1  | Animation states .....                               | 641 |
| 5.8        | Movies .....   | 642 |
| 5.8.1      | Introduction .....                                   | 642 |
| 5.8.2      | Requirements .....                                   | 643 |
| 5.8.3      | Creating JPEG files with FFmpeg.exe .....            | 643 |
| 5.8.4      | Creating an EMF file .....                           | 644 |
| 5.8.5      | Creating an AVI file .....                           | 646 |
| 5.8.6      | Modifying the conversion result .....                | 646 |
| 5.8.7      | Using JPEG2Movie .....                               | 646 |
| 5.8.8      | Bitmap-EMF files .....                               | 647 |
| 5.8.8.1    | Sample program to run EMF from external memory ..... | 648 |
| 5.8.9      | emWin Movie Player .....                             | 651 |
| 5.8.10     | Movies API .....                                     | 652 |
| 5.8.10.1   | Functions .....                                      | 653 |
| 5.8.10.1.1 | GUI_MOVIE_Create() .....                             | 653 |
| 5.8.10.1.2 | GUI_MOVIE_CreateEx() .....                           | 654 |
| 5.8.10.1.3 | GUI_MOVIE_Delete() .....                             | 655 |
| 5.8.10.1.4 | GUI_MOVIE_DrawFrame() .....                          | 656 |

|             |   |     |
|-------------|---|-----|
| 5.8.10.1.5  | GUI_MOVIE_GetFrameIndex()                             | 657 |
| 5.8.10.1.6  | GUI_MOVIE_GetInfo()                                   | 658 |
| 5.8.10.1.7  | GUI_MOVIE_GetInfoEx()                                 | 659 |
| 5.8.10.1.8  | GUI_MOVIE_GetInfoH()                                  | 660 |
| 5.8.10.1.9  | GUI_MOVIE_GetNumFrames()                              | 661 |
| 5.8.10.1.10 | GUI_MOVIE_GetPos()                                    | 662 |
| 5.8.10.1.11 | GUI_MOVIE_GotoFrame()                                 | 663 |
| 5.8.10.1.12 | GUI_MOVIE_Pause()                                     | 664 |
| 5.8.10.1.13 | GUI_MOVIE_Play()                                      | 665 |
| 5.8.10.1.14 | GUI_MOVIE_SetPeriod()                                 | 666 |
| 5.8.10.1.15 | GUI_MOVIE_SetpfNotify()                               | 667 |
| 5.8.10.1.16 | GUI_MOVIE_SetPos()                                    | 668 |
| 5.8.10.1.17 | GUI_MOVIE_Show()                                      | 669 |
| 5.8.10.2    | Data structures                                       | 670 |
| 5.8.10.2.1  | GUI_MOVIE_INFO  | 670 |
| 5.8.10.3    | Defines   | 671 |
| 5.8.10.3.1  | Movie notifications                                   | 671 |
| 5.9         | Pointer Input Devices                                 | 672 |
| 5.9.1       | Description   | 672 |
| 5.9.2       | Pointer input device API                              | 672 |
| 5.9.2.1     | Functions   | 673 |
| 5.9.2.1.1   | GUI_PID_GetCurrentState()                             | 673 |
| 5.9.2.1.2   | GUI_PID_GetState()                                    | 674 |
| 5.9.2.1.3   | GUI_PID_IsEmpty()                                     | 675 |
| 5.9.2.1.4   | GUI_PID_IsPressed()                                   | 676 |
| 5.9.2.1.5   | GUI_PID_SetHook()                                     | 677 |
| 5.9.2.1.6   | GUI_PID_StoreState()                                  | 678 |
| 5.9.2.2     | Data structures                                       | 679 |
| 5.9.2.2.1   | GUI_PID_STATE   | 679 |
| 5.9.3       | Mouse driver  | 680 |
| 5.9.3.1     | Generic mouse driver API                              | 680 |
| 5.9.3.1.1   | GUI_MOUSE_GetState()                                  | 681 |
| 5.9.3.1.2   | GUI_MOUSE_StoreState()                                | 682 |
| 5.9.3.2     | PS2 mouse driver                                      | 683 |
| 5.9.3.2.1   | Using the PS2 mouse driver                            | 683 |
| 5.9.3.2.2   | PS2 mouse driver API                                  | 683 |
| 5.9.4       | Touch screen driver                                   | 686 |
| 5.9.4.1     | Generic touch screen API                              | 686 |
| 5.9.4.1.1   | GUI_TOUCH_GetState()                                  | 687 |
| 5.9.4.1.2   | GUI_TOUCH_StoreState()                                | 688 |
| 5.9.4.1.3   | GUI_TOUCH_StoreStateEx()                              | 689 |
| 5.9.4.2     | The analog touch screen driver                        | 690 |
| 5.9.4.2.1   | Setting up the analog touch screen                    | 690 |
| 5.9.4.2.2   | Runtime calibration                                   | 692 |
| 5.9.4.2.3   | Hardware routines                                     | 693 |
| 5.9.4.2.4   | Driver API for analog touch screens                   | 697 |
| 5.9.4.2.5   | Configuring the analog touch-screen driver            | 702 |
| 5.9.5       | Touch screen calibration                              | 703 |
| 5.9.5.1     | Using calibration with the analog touch screen driver | 704 |
| 5.9.5.2     | Using calibration with a custom touch screen driver   | 704 |
| 5.9.5.3     | Calibration API                                       | 705 |
| 5.9.5.3.1   | GUI_TOUCH_CalcCoefficients()                          | 706 |
| 5.9.5.3.2   | GUI_TOUCH_CalibratePoint()                            | 707 |
| 5.9.5.3.3   | GUI_TOUCH_EnableCalibration()                         | 708 |
| 5.9.5.3.4   | GUI_TOUCH_TransformPoint()                            | 709 |
| 5.9.6       | Joystick input example                                | 710 |
| 5.10        | Multiple Buffering                                    | 712 |
| 5.10.1      | How it works  | 712 |
| 5.10.1.1    | Double Buffering                                      | 713 |
| 5.10.1.2    | Triple Buffering                                      | 713 |

|            |   |     |
|------------|---|-----|
| 5.10.2     | Requirements .....                                    | 713 |
| 5.10.3     | Limitations .....                                     | 713 |
| 5.10.4     | Configuration .....                                   | 714 |
| 5.10.4.1   | LCD_X_Config() .....                                  | 714 |
| 5.10.4.2   | LCD_X_DisplayDriver() .....                           | 715 |
| 5.10.5     | Automatic use of multiple buffers with the WM .....   | 716 |
| 5.10.6     | Multiple Buffering API .....                          | 717 |
| 5.10.6.1   | GUI_MULTIBUF_Begin() .....                            | 718 |
| 5.10.6.2   | GUI_MULTIBUF_BeginEx() .....                          | 719 |
| 5.10.6.3   | GUI_MULTIBUF_Config() .....                           | 720 |
| 5.10.6.4   | GUI_MULTIBUF_ConfigEx() .....                         | 721 |
| 5.10.6.5   | GUI_MULTIBUF_Confirm() .....                          | 722 |
| 5.10.6.6   | GUI_MULTIBUF_ConfirmEx() .....                        | 723 |
| 5.10.6.7   | GUI_MULTIBUF_End() .....                              | 724 |
| 5.10.6.8   | GUI_MULTIBUF_EndEx() .....                            | 725 |
| 5.10.6.9   | GUI_MULTIBUF_GetNumBuffers() .....                    | 726 |
| 5.10.6.10  | GUI_MULTIBUF_GetNumBuffersEx() .....                  | 727 |
| 5.10.6.11  | GUI_MULTIBUF_UseSingleBuffer() .....                  | 728 |
| 5.11       | Keyboard Input .....                                  | 729 |
| 5.11.1     | Description .....                                     | 729 |
| 5.11.2     | Driver layer API .....                                | 729 |
| 5.11.2.1   | GUI_StoreKeyMsg() .....                               | 730 |
| 5.11.2.2   | GUI_SendKeyMsg() .....                                | 731 |
| 5.11.3     | Application layer API .....                           | 732 |
| 5.11.3.1   | GUI_ClearKeyBuffer() .....                            | 733 |
| 5.11.3.2   | GUI_GetKey() .....                                    | 734 |
| 5.11.3.3   | GUI_GetKeyState() .....                               | 735 |
| 5.11.3.4   | GUI_StoreKey() .....                                  | 736 |
| 5.11.3.5   | GUI_WaitKey() .....                                   | 737 |
| 5.11.4     | Data structure .....                                  | 738 |
| 5.11.4.1   | GUI_KEY_STATE .....                                   | 738 |
| 5.12       | Language Support .....                                | 739 |
| 5.12.1     | Unicode .....   | 739 |
| 5.12.1.1   | UTF-8 encoding .....                                  | 739 |
| 5.12.1.2   | Unicode characters .....                              | 740 |
| 5.12.1.3   | UTF-8 strings .....                                   | 740 |
| 5.12.1.3.1 | Using U2C.exe to convert UTF-8 text into C code ..... | 740 |
| 5.12.1.4   | Unicode API .....                                     | 742 |
| 5.12.1.4.1 | UTF-8 functions .....                                 | 743 |
| 5.12.1.4.2 | Double byte functions .....                           | 755 |
| 5.12.2     | Text- and language resource files .....               | 756 |
| 5.12.2.1   | Unicode support .....                                 | 756 |
| 5.12.2.2   | Loading files from RAM .....                          | 756 |
| 5.12.2.3   | Loading files from non addressable areas .....        | 756 |
| 5.12.2.4   | Rules for CSV files .....                             | 756 |
| 5.12.2.5   | Rules for text files .....                            | 756 |
| 5.12.2.6   | Text- and language resource file API .....            | 757 |
| 5.12.2.6.1 | Text file functions .....                             | 758 |
| 5.12.2.6.2 | CSV file functions .....                              | 760 |
| 5.12.2.6.3 | Common functions .....                                | 762 |
| 5.12.3     | Right to left- and bidirectional text .....           | 774 |
| 5.12.3.1   | Bidirectional text algorithm .....                    | 774 |
| 5.12.3.2   | Basic text direction .....                            | 774 |
| 5.12.3.3   | Mirroring .....                                       | 774 |
| 5.12.3.4   | Requirements .....                                    | 774 |
| 5.12.3.5   | Maximum characters per line .....                     | 774 |
| 5.12.4     | Arabic support .....                                  | 776 |
| 5.12.4.1   | Notation forms .....                                  | 776 |
| 5.12.4.2   | Ligatures .....                                       | 777 |
| 5.12.4.3   | How to enable Arabic support .....                    | 778 |

|           |  |     |
|-----------|--|-----|
| 5.12.4.4  | Example .....  | 778 |
| 5.12.4.5  | Font files used with Arabic text .....                               | 778 |
| 5.12.5    | Thai language support .....  | 779 |
| 5.12.5.1  | Requirements .....   | 779 |
| 5.12.5.2  | How to enable Thai support .....                                     | 779 |
| 5.12.5.3  | Example .....  | 779 |
| 5.12.5.4  | Font files used with Thai text .....                                 | 779 |
| 5.12.6    | Shift JIS support .....  | 780 |
| 5.12.6.1  | Creating Shift JIS fonts .....                                       | 780 |
| 5.12.7    | Limitations .....  | 780 |
| 5.13      | Timing- and execution-related functions .....                        | 781 |
| 5.13.1    | Timing and execution API .....                                       | 781 |
| 5.13.1.1  | GUI_Delay() .....  | 782 |
| 5.13.1.2  | GUI_Exec() .....   | 783 |
| 5.13.1.3  | GUI_Exec1() .....  | 784 |
| 5.13.1.4  | GUI_GetTime() .....  | 785 |
| 5.13.1.5  | GUI_GetTimeSlice() .....   | 786 |
| 5.13.1.6  | GUI_SetTimeSlice() .....   | 787 |
| 5.13.2    | Verbosity API .....  | 788 |
| 5.13.2.1  | GUI_ErrorOut() .....   | 789 |
| 5.13.2.2  | GUI_Log() .....  | 790 |
| 5.13.2.3  | GUI_Warn() .....   | 791 |
| 5.13.3    | Timer API .....  | 792 |
| 5.13.3.1  | GUI_TIMER_Create() .....   | 793 |
| 5.13.3.2  | GUI_TIMER_Delete() .....   | 794 |
| 5.13.3.3  | GUI_TIMER_Restart() .....  | 795 |
| 5.13.3.4  | GUI_TIMER_SetPeriod() .....  | 796 |
| 6         | Advanced features .....  | 797 |
| 6.1       | The Window Manager (WM) .....  | 798 |
| 6.1.1     | Description of terms .....   | 798 |
| 6.1.2     | Callback mechanism, invalidation, rendering and keyboard input ..... | 801 |
| 6.1.2.1   | Rendering using callbacks .....                                      | 801 |
| 6.1.2.2   | Overwriting callback functions .....                                 | 802 |
| 6.1.2.3   | Background window redrawing and callback .....                       | 803 |
| 6.1.2.4   | Invalidation .....   | 803 |
| 6.1.2.5   | Tiling mechanism .....   | 803 |
| 6.1.2.6   | Rendering of transparent windows .....                               | 805 |
| 6.1.2.7   | Automatic use of Memory Devices .....                                | 805 |
| 6.1.2.8   | Automatic use of multiple frame buffers .....                        | 805 |
| 6.1.2.9   | Automatic use of display driver cache .....                          | 805 |
| 6.1.2.10  | Keyboard input .....   | 805 |
| 6.1.3     | Motion support .....   | 806 |
| 6.1.3.1   | Enabling motion support of the WM .....                              | 806 |
| 6.1.3.2   | Basic motion support for a window .....                              | 806 |
| 6.1.3.2.1 | Using creation flags .....   | 806 |
| 6.1.3.2.2 | Using API function .....   | 806 |
| 6.1.3.3   | Motion processing by application .....                               | 806 |
| 6.1.3.3.1 | WM_MOTION message and WM_MOTION_INFO .....                           | 807 |
| 6.1.3.4   | Motion support for circular moves .....                              | 808 |
| 6.1.3.5   | Widgets with motion support .....                                    | 808 |
| 6.1.4     | Window manager and multiple layers .....                             | 809 |
| 6.1.4.1   | Drawing operations .....   | 809 |
| 6.1.4.2   | Window relationship .....  | 809 |
| 6.1.4.3   | Semi-transparency .....  | 809 |
| 6.1.4.4   | Touch input .....  | 809 |
| 6.1.4.5   | Memory devices .....   | 809 |
| 6.1.5     | ToolTips .....   | 810 |
| 6.1.5.1   | How they work .....  | 810 |

|            |  |     |
|------------|--|-----|
| 6.1.5.2    | Creating ToolTips .....                    | 810 |
| 6.1.5.2.1  | Creating ToolTips for dialog items .....   | 810 |
| 6.1.5.2.2  | Creating ToolTips for simple windows ..... | 811 |
| 6.1.6      | Messages .....                             | 812 |
| 6.1.6.1    | Message structure .....                    | 812 |
| 6.1.6.2    | List of messages .....                     | 812 |
| 6.1.6.3    | System-defined messages .....              | 812 |
| 6.1.6.3.1  | WM_CREATE .....                            | 812 |
| 6.1.6.3.2  | WM_DELETE .....                            | 812 |
| 6.1.6.3.3  | WM_GET_ID .....                            | 812 |
| 6.1.6.3.4  | WM_GET_INSIDE_RECT .....                   | 812 |
| 6.1.6.3.5  | WM_INIT_DIALOG .....                       | 813 |
| 6.1.6.3.6  | WM_KEY .....                               | 813 |
| 6.1.6.3.7  | WM_MOVE .....                              | 813 |
| 6.1.6.3.8  | WM_NOTIFY_PARENT .....                     | 813 |
| 6.1.6.3.9  | WM_NOTIFY_VIS_CHANGED .....                | 813 |
| 6.1.6.3.10 | WM_PAINT .....                             | 814 |
| 6.1.6.3.11 | WM_POST_PAINT .....                        | 814 |
| 6.1.6.3.12 | WM_PRE_PAINT .....                         | 814 |
| 6.1.6.3.13 | WM_SET_CALLBACK .....                      | 814 |
| 6.1.6.3.14 | WM_SET_FOCUS .....                         | 815 |
| 6.1.6.3.15 | WM_SET_ID .....                            | 815 |
| 6.1.6.3.16 | WM_SIZE .....                              | 815 |
| 6.1.6.3.17 | WM_TIMER .....                             | 815 |
| 6.1.6.3.18 | WM_USER_DATA .....                         | 815 |
| 6.1.6.4    | Pointer input device (PID) messages .....  | 815 |
| 6.1.6.4.1  | WM_MOTION .....                            | 816 |
| 6.1.6.4.2  | WM_MOUSEOVER .....                         | 816 |
| 6.1.6.4.3  | WM_MOUSEOVER_END .....                     | 816 |
| 6.1.6.4.4  | WM_PID_STATE_CHANGED .....                 | 816 |
| 6.1.6.4.5  | WM_TOUCH .....                             | 816 |
| 6.1.6.4.6  | WM_TOUCH_CHILD .....                       | 817 |
| 6.1.6.4.7  | Example .....                              | 817 |
| 6.1.6.5    | System-defined notification codes .....    | 818 |
| 6.1.6.6    | Application-defined messages .....         | 818 |
| 6.1.7      | Configuration options .....                | 819 |
| 6.1.7.1    | WM_SUPPORT_NOTIFY_VIS_CHANGED .....        | 819 |
| 6.1.7.2    | WM_SUPPORT_TRANSPARENCY .....              | 819 |
| 6.1.8      | WM API .....                               | 820 |
| 6.1.8.1    | Using the WM API functions .....           | 825 |
| 6.1.8.2    | Basic functions .....                      | 826 |
| 6.1.8.2.1  | WM_Activate() .....                        | 826 |
| 6.1.8.2.2  | WM_AttachWindow() .....                    | 827 |
| 6.1.8.2.3  | WM_AttachWindowAt() .....                  | 828 |
| 6.1.8.2.4  | WM_BringToBottom() .....                   | 829 |
| 6.1.8.2.5  | WM_BringToTop() .....                      | 830 |
| 6.1.8.2.6  | WM_BroadcastMessage() .....                | 831 |
| 6.1.8.2.7  | WM_ClrHasTrans() .....                     | 832 |
| 6.1.8.2.8  | WM_CreateWindow() .....                    | 833 |
| 6.1.8.2.9  | WM_CreateWindowAsChild() .....             | 834 |
| 6.1.8.2.10 | WM_Deactivate() .....                      | 835 |
| 6.1.8.2.11 | WM_DefaultProc() .....                     | 836 |
| 6.1.8.2.12 | WM_DeleteWindow() .....                    | 837 |
| 6.1.8.2.13 | WM_DeleteWindowSecure() .....              | 838 |
| 6.1.8.2.14 | WM_DetachWindow() .....                    | 839 |
| 6.1.8.2.15 | WM_DisableWindow() .....                   | 840 |
| 6.1.8.2.16 | WM_EnableWindow() .....                    | 841 |
| 6.1.8.2.17 | WM_Exec() .....                            | 842 |
| 6.1.8.2.18 | WM_Exec1() .....                           | 843 |
| 6.1.8.2.19 | WM_ForEachDesc() .....                     | 844 |

|            |                           |     |
|------------|---------------------------|-----|
| 6.1.8.2.20 | WM_GetActiveWindow()      | 846 |
| 6.1.8.2.21 | WM_GetCallback()          | 847 |
| 6.1.8.2.22 | WM_GetClientRect()        | 848 |
| 6.1.8.2.23 | WM_GetClientRectEx()      | 849 |
| 6.1.8.2.24 | WM_GetDesktopWindow()     | 850 |
| 6.1.8.2.25 | WM_GetDesktopWindowEx()   | 851 |
| 6.1.8.2.26 | WM_GetDialogItem()        | 852 |
| 6.1.8.2.27 | WM_GetFirstChild()        | 853 |
| 6.1.8.2.28 | WM_GetFocusedWindow()     | 854 |
| 6.1.8.2.29 | WM_GetHasTrans()          | 855 |
| 6.1.8.2.30 | WM_GetInvalidRect()       | 856 |
| 6.1.8.2.31 | WM_GetModalLayer()        | 857 |
| 6.1.8.2.32 | WM_GetModalWindow()       | 858 |
| 6.1.8.2.33 | WM_GetNextSibling()       | 859 |
| 6.1.8.2.34 | WM_GetNumInvalidWindows() | 860 |
| 6.1.8.2.35 | WM_GetOrgX()              | 861 |
| 6.1.8.2.36 | WM_GetOrgY()              | 861 |
| 6.1.8.2.37 | WM_GetParent()            | 862 |
| 6.1.8.2.38 | WM_GetPrevSibling()       | 863 |
| 6.1.8.2.39 | WM_GetStayOnTop()         | 864 |
| 6.1.8.2.40 | WM_GetUserData()          | 865 |
| 6.1.8.2.41 | WM_GetWindowOrgX()        | 866 |
| 6.1.8.2.42 | WM_GetWindowOrgY()        | 866 |
| 6.1.8.2.43 | WM_GetWindowRect()        | 867 |
| 6.1.8.2.44 | WM_GetWindowRectEx()      | 868 |
| 6.1.8.2.45 | WM_GetWindowSizeX()       | 869 |
| 6.1.8.2.46 | WM_GetWindowSizeY()       | 869 |
| 6.1.8.2.47 | WM_HasCaptured()          | 870 |
| 6.1.8.2.48 | WM_HasFocus()             | 871 |
| 6.1.8.2.49 | WM_HideWindow()           | 872 |
| 6.1.8.2.50 | WM_InvalidateArea()       | 873 |
| 6.1.8.2.51 | WM_InvalidateRect()       | 874 |
| 6.1.8.2.52 | WM_InvalidateWindow()     | 875 |
| 6.1.8.2.53 | WM_IsCompletelyCovered()  | 876 |
| 6.1.8.2.54 | WM_IsCompletelyVisible()  | 877 |
| 6.1.8.2.55 | WM_IsEnabled()            | 878 |
| 6.1.8.2.56 | WM_IsUntouchable()        | 879 |
| 6.1.8.2.57 | WM_IsVisible()            | 880 |
| 6.1.8.2.58 | WM_IsWindow()             | 881 |
| 6.1.8.2.59 | WM_MakeModal()            | 882 |
| 6.1.8.2.60 | WM_MoveChildTo()          | 883 |
| 6.1.8.2.61 | WM_MoveTo()               | 884 |
| 6.1.8.2.62 | WM_MoveWindow()           | 885 |
| 6.1.8.2.63 | WM_NotifyParent()         | 886 |
| 6.1.8.2.64 | WM_Paint()                | 887 |
| 6.1.8.2.65 | WM_PaintWindowAndDescs()  | 888 |
| 6.1.8.2.66 | WM_Rect2Client()          | 889 |
| 6.1.8.2.67 | WM_Rect2Screen()          | 890 |
| 6.1.8.2.68 | WM_ReleaseCapture()       | 891 |
| 6.1.8.2.69 | WM_ResizeWindow()         | 892 |
| 6.1.8.2.70 | WM_Screen2hWin()          | 893 |
| 6.1.8.2.71 | WM_Screen2hWinEx()        | 894 |
| 6.1.8.2.72 | WM_SelectWindow()         | 895 |
| 6.1.8.2.73 | WM_SendMessage()          | 896 |
| 6.1.8.2.74 | WM_SendMessageNoPara()    | 897 |
| 6.1.8.2.75 | WM_SendToParent()         | 898 |
| 6.1.8.2.76 | WM_SetCallback()          | 899 |
| 6.1.8.2.77 | WM_SetCapture()           | 900 |
| 6.1.8.2.78 | WM_SetCaptureMove()       | 901 |
| 6.1.8.2.79 | WM_SetCreateFlags()       | 902 |



|             |                                  |     |
|-------------|----------------------------------|-----|
| 6.1.8.2.80  | WM_SetDesktopColor()             | 903 |
| 6.1.8.2.81  | WM_SetDesktopColorEx()           | 904 |
| 6.1.8.2.82  | WM_SetEnableState()              | 905 |
| 6.1.8.2.83  | WM_SetFocus()                    | 906 |
| 6.1.8.2.84  | WM_SetHasTrans()                 | 907 |
| 6.1.8.2.85  | WM_SetId()                       | 908 |
| 6.1.8.2.86  | WM_SetModalLayer()               | 909 |
| 6.1.8.2.87  | WM_SetpfPollPID()                | 910 |
| 6.1.8.2.88  | WM_SetSize()                     | 911 |
| 6.1.8.2.89  | WM_SetUntouchable()              | 912 |
| 6.1.8.2.90  | WM_SetWindowPos()                | 913 |
| 6.1.8.2.91  | WM_SetXSize()                    | 914 |
| 6.1.8.2.92  | WM_SetYSize()                    | 915 |
| 6.1.8.2.93  | WM_SetStayOnTop()                | 916 |
| 6.1.8.2.94  | WM_SetTransState()               | 917 |
| 6.1.8.2.95  | WM_SetUserClipRect()             | 918 |
| 6.1.8.2.96  | WM_SetUserData()                 | 919 |
| 6.1.8.2.97  | WM_ShowWindow()                  | 920 |
| 6.1.8.2.98  | WM_Update()                      | 921 |
| 6.1.8.2.99  | WM_UpdateWindowAndDescs()        | 922 |
| 6.1.8.2.100 | WM_ValidateRect()                | 923 |
| 6.1.8.2.101 | WM_ValidateWindow()              | 924 |
| 6.1.8.2.102 | WM_XY2Screen()                   | 925 |
| 6.1.8.2.103 | WM_XY2Client()                   | 926 |
| 6.1.8.3     | Motion support                   | 927 |
| 6.1.8.3.1   | WM_MOTION_Enable()               | 927 |
| 6.1.8.3.2   | WM_MOTION_SetDeceleration()      | 928 |
| 6.1.8.3.3   | WM_MOTION_SetDefaultPeriod()     | 929 |
| 6.1.8.3.4   | WM_MOTION_SetMotion()            | 930 |
| 6.1.8.3.5   | WM_MOTION_SetMoveable()          | 931 |
| 6.1.8.3.6   | WM_MOTION_SetMovement()          | 932 |
| 6.1.8.3.7   | WM_MOTION_SetSpeed()             | 933 |
| 6.1.8.3.8   | WM_MOTION_SetThreshold()         | 934 |
| 6.1.8.4     | ToolTip related functions        | 935 |
| 6.1.8.4.1   | WM_TOOLTIP_AddTool()             | 935 |
| 6.1.8.4.2   | WM_TOOLTIP_Create()              | 936 |
| 6.1.8.4.3   | WM_TOOLTIP_Delete()              | 937 |
| 6.1.8.4.4   | WM_TOOLTIP_SetDefaultColor()     | 938 |
| 6.1.8.4.5   | WM_TOOLTIP_SetDefaultFont()      | 939 |
| 6.1.8.4.6   | WM_TOOLTIP_SetDefaultPeriod()    | 940 |
| 6.1.8.5     | Multiple Buffering support       | 941 |
| 6.1.8.5.1   | WM_MULTIBUF_Enable()             | 941 |
| 6.1.8.6     | Memory Device support (optional) | 942 |
| 6.1.8.6.1   | WM_DisableMemdev()               | 942 |
| 6.1.8.6.2   | WM_EnableMemdev()                | 943 |
| 6.1.8.7     | Timer related                    | 944 |
| 6.1.8.7.1   | WM_CreateTimer()                 | 944 |
| 6.1.8.7.2   | WM_DeleteTimer()                 | 945 |
| 6.1.8.7.3   | WM_GetTimerId()                  | 946 |
| 6.1.8.7.4   | WM_RestartTimer()                | 947 |
| 6.1.8.8     | Widget related functions         | 948 |
| 6.1.8.8.1   | WM_GetClientWindow()             | 948 |
| 6.1.8.8.2   | WM_GetContentRect()              | 949 |
| 6.1.8.8.3   | WM_GetContentRectEx()            | 950 |
| 6.1.8.8.4   | WM_GetId()                       | 951 |
| 6.1.8.8.5   | WM_GetInsideRect()               | 952 |
| 6.1.8.8.6   | WM_GetInsideRectEx()             | 953 |
| 6.1.8.8.7   | WM_GetScrollbarH()               | 954 |
| 6.1.8.8.8   | WM_GetScrollbarV()               | 955 |
| 6.1.8.8.9   | WM_GetScrollPosH()               | 956 |

|            |   |      |
|------------|---|------|
| 6.1.8.8.10 | WM_GetScrollPosV()                                  | 957  |
| 6.1.8.8.11 | WM_GetScrollState()                                 | 958  |
| 6.1.8.8.12 | WM_SetScrollPosH()                                  | 959  |
| 6.1.8.8.13 | WM_SetScrollPosV()                                  | 960  |
| 6.1.8.8.14 | WM_SetScrollState()                                 | 961  |
| 6.1.8.9    | Data structures                                     | 962  |
| 6.1.8.9.1  | TOOLTIP_INFO  | 962  |
| 6.1.8.9.2  | WM_KEY_INFO   | 963  |
| 6.1.8.9.3  | WM_MESSAGE  | 964  |
| 6.1.8.9.4  | WM_MOTION_INFO                                      | 965  |
| 6.1.8.9.5  | WM_MOVE_INFO  | 966  |
| 6.1.8.9.6  | WM_PID_STATE_CHANGED_INFO                           | 967  |
| 6.1.8.9.7  | WM_SCROLL_STATE                                     | 968  |
| 6.1.8.10   | Defines   | 969  |
| 6.1.8.10.1 | Message IDs   | 969  |
| 6.1.8.10.2 | Motion flags  | 971  |
| 6.1.8.10.3 | Motion messages                                     | 972  |
| 6.1.8.10.4 | Motion overlap flags                                | 973  |
| 6.1.8.10.5 | Notification codes                                  | 974  |
| 6.1.8.10.6 | ToolTip color indexes                               | 975  |
| 6.1.8.10.7 | ToolTip period indexes                              | 976  |
| 6.1.8.10.8 | Window create flags                                 | 977  |
| 6.1.9      | Example   | 980  |
| 6.2        | Widgets (window objects)                            | 982  |
| 6.2.1      | Some basics   | 982  |
| 6.2.1.1    | Available widgets                                   | 982  |
| 6.2.1.2    | Custom widget types                                 | 985  |
| 6.2.1.3    | Understanding the redrawing mechanism               | 985  |
| 6.2.1.4    | How to use widgets                                  | 985  |
| 6.2.2      | Configuration options                               | 988  |
| 6.2.3      | Widget IDs  | 989  |
| 6.2.4      | General widget API                                  | 990  |
| 6.2.4.1    | WM routines used for widgets                        | 990  |
| 6.2.4.2    | Common routines                                     | 990  |
| 6.2.4.2.1  | <WIDGET>_Callback()                                 | 991  |
| 6.2.4.2.2  | <WIDGET>_CreateIndirect()                           | 992  |
| 6.2.4.2.3  | <WIDGET>_CreateUser()                               | 993  |
| 6.2.4.2.4  | <WIDGET>_GetUserData()                              | 994  |
| 6.2.4.2.5  | <WIDGET>_SetUserData()                              | 995  |
| 6.2.4.2.6  | WIDGET_EnableStreamAuto()                           | 996  |
| 6.2.4.2.7  | WIDGET_GetDefaultEffect()                           | 997  |
| 6.2.4.2.8  | WIDGET_SetDefaultEffect()                           | 998  |
| 6.2.4.2.9  | WIDGET_SetEffect()                                  | 999  |
| 6.2.4.2.10 | WIDGET_SetFocusable()                               | 1000 |
| 6.2.4.3    | User drawn widgets                                  | 1001 |
| 6.2.5      | BUTTON: Button widget                               | 1003 |
| 6.2.5.1    | Configuration options                               | 1003 |
| 6.2.5.1.1  | BUTTON_REACT_ON_LEVEL                               | 1003 |
| 6.2.5.1.2  | BUTTON_BKCOLOR0_DEFAULT,<br>BUTTON_BKCOLOR1_DEFAULT | 1004 |
| 6.2.5.2    | Predefined IDs                                      | 1004 |
| 6.2.5.3    | Notification codes                                  | 1004 |
| 6.2.5.4    | Keyboard reaction                                   | 1005 |
| 6.2.5.5    | BUTTON API  | 1005 |
| 6.2.5.5.1  | Functions   | 1007 |
| 6.2.5.5.2  | Defines   | 1050 |
| 6.2.5.6    | Examples  | 1052 |
| 6.2.6      | CHECKBOX: Checkbox widget                           | 1053 |
| 6.2.6.1    | Configuration options                               | 1053 |
| 6.2.6.2    | Predefined IDs                                      | 1054 |

|            |  |      |
|------------|--|------|
| 6.2.6.3    | Notification codes .....                   | 1054 |
| 6.2.6.4    | Keyboard reaction .....                    | 1054 |
| 6.2.6.5    | CHECKBOX API .....                         | 1055 |
| 6.2.6.5.1  | Functions .....                            | 1057 |
| 6.2.6.5.2  | Defines .....                              | 1100 |
| 6.2.6.6    | Example .....                              | 1102 |
| 6.2.7      | DROPDOWN: Dropdown widget .....            | 1103 |
| 6.2.7.1    | Configuration options .....                | 1103 |
| 6.2.7.2    | Predefined IDs .....                       | 1104 |
| 6.2.7.3    | Notification codes .....                   | 1104 |
| 6.2.7.4    | Keyboard reaction .....                    | 1104 |
| 6.2.7.5    | DROPDOWN API .....                         | 1105 |
| 6.2.7.5.1  | Functions .....                            | 1107 |
| 6.2.7.5.2  | Defines .....                              | 1154 |
| 6.2.7.6    | Example .....                              | 1157 |
| 6.2.8      | EDIT: Edit widget .....                    | 1158 |
| 6.2.8.1    | Configuration options .....                | 1158 |
| 6.2.8.2    | Predefined IDs .....                       | 1158 |
| 6.2.8.3    | Notification codes .....                   | 1159 |
| 6.2.8.4    | Keyboard reaction .....                    | 1159 |
| 6.2.8.5    | EDIT API .....                             | 1160 |
| 6.2.8.5.1  | Functions .....                            | 1162 |
| 6.2.8.5.2  | Defines .....                              | 1216 |
| 6.2.8.6    | Examples .....                             | 1218 |
| 6.2.9      | FRAMEWIN: Frame window widget .....        | 1219 |
| 6.2.9.1    | Structure of the frame window .....        | 1220 |
| 6.2.9.2    | Configuration options .....                | 1221 |
| 6.2.9.3    | Keyboard reaction .....                    | 1221 |
| 6.2.9.4    | FRAMEWIN API .....                         | 1221 |
| 6.2.9.4.1  | Functions .....                            | 1224 |
| 6.2.9.4.2  | Defines .....                              | 1276 |
| 6.2.9.5    | Example .....                              | 1279 |
| 6.2.10     | GAUGE: Gauge widget .....                  | 1280 |
| 6.2.10.1   | Configuration options .....                | 1280 |
| 6.2.10.2   | Predefined IDs .....                       | 1280 |
| 6.2.10.3   | Notification codes .....                   | 1281 |
| 6.2.10.4   | Keyboard reaction .....                    | 1281 |
| 6.2.10.5   | GAUGE API .....                            | 1281 |
| 6.2.10.5.1 | Functions .....                            | 1282 |
| 6.2.10.5.2 | Defines .....                              | 1297 |
| 6.2.11     | GRAPH: Graph widget .....                  | 1298 |
| 6.2.11.1   | Structure of the graph widget .....        | 1298 |
| 6.2.11.2   | Creating and deleting a graph widget ..... | 1299 |
| 6.2.11.3   | Drawing process .....                      | 1299 |
| 6.2.11.4   | Supported types of curves .....            | 1299 |
| 6.2.11.4.1 | GRAPH_DATA_XY .....                        | 1300 |
| 6.2.11.4.2 | GRAPH_DATA_YT .....                        | 1300 |
| 6.2.11.5   | Configuration options .....                | 1300 |
| 6.2.11.5.1 | Graph widget .....                         | 1300 |
| 6.2.11.5.2 | Scale object .....                         | 1300 |
| 6.2.11.6   | Predefined IDs .....                       | 1301 |
| 6.2.11.7   | Keyboard reaction .....                    | 1301 |
| 6.2.11.8   | GRAPH API .....                            | 1301 |
| 6.2.11.8.1 | Common routines .....                      | 1304 |
| 6.2.11.8.2 | GRAPH_DATA_YT related routines .....       | 1330 |
| 6.2.11.8.3 | GRAPH_DATA_XY related routines .....       | 1339 |
| 6.2.11.8.4 | Scale related routines .....               | 1353 |
| 6.2.11.8.5 | Defines .....                              | 1362 |
| 6.2.11.9   | Examples .....                             | 1367 |
| 6.2.12     | HEADER: Header widget .....                | 1368 |

|             |                                    |      |
|-------------|------------------------------------|------|
| 6.2.12.1    | Configuration options .....        | 1368 |
| 6.2.12.2    | Notification codes .....           | 1369 |
| 6.2.12.3    | Keyboard reaction .....            | 1369 |
| 6.2.12.4    | HEADER API .....                   | 1369 |
| 6.2.12.4.1  | HEADER_AddItem() .....             | 1372 |
| 6.2.12.4.2  | HEADER_Create() .....              | 1373 |
| 6.2.12.4.3  | HEADER_CreateAttached() .....      | 1374 |
| 6.2.12.4.4  | HEADER_CreateEx() .....            | 1375 |
| 6.2.12.4.5  | HEADER_CreateIndirect() .....      | 1376 |
| 6.2.12.4.6  | HEADER_CreateUser() .....          | 1377 |
| 6.2.12.4.7  | HEADER_DeleteItem() .....          | 1378 |
| 6.2.12.4.8  | HEADER_GetBkColor() .....          | 1379 |
| 6.2.12.4.9  | HEADER_GetBorderH() .....          | 1380 |
| 6.2.12.4.10 | HEADER_GetBorderV() .....          | 1381 |
| 6.2.12.4.11 | HEADER_GetColumnFromPos() .....    | 1382 |
| 6.2.12.4.12 | HEADER_GetDefaultBkColor() .....   | 1383 |
| 6.2.12.4.13 | HEADER_GetDefaultBorderH() .....   | 1384 |
| 6.2.12.4.14 | HEADER_GetDefaultBorderV() .....   | 1385 |
| 6.2.12.4.15 | HEADER_GetDefaultCursor() .....    | 1386 |
| 6.2.12.4.16 | HEADER_GetDefaultFont() .....      | 1387 |
| 6.2.12.4.17 | HEADER_GetDefaultTextColor() ..... | 1388 |
| 6.2.12.4.18 | HEADER_GetFont() .....             | 1389 |
| 6.2.12.4.19 | HEADER_GetHeight() .....           | 1390 |
| 6.2.12.4.20 | HEADER_GetItemText() .....         | 1391 |
| 6.2.12.4.21 | HEADER_GetItemWidth() .....        | 1392 |
| 6.2.12.4.22 | HEADER_GetNumItems() .....         | 1393 |
| 6.2.12.4.23 | HEADER_GetSel() .....              | 1394 |
| 6.2.12.4.24 | HEADER_GetTextColor() .....        | 1395 |
| 6.2.12.4.25 | HEADER_GetUserData() .....         | 1396 |
| 6.2.12.4.26 | HEADER_SetBitmap() .....           | 1397 |
| 6.2.12.4.27 | HEADER_SetBitmapEx() .....         | 1398 |
| 6.2.12.4.28 | HEADER_SetBkColor() .....          | 1399 |
| 6.2.12.4.29 | HEADER_SetBMP() .....              | 1400 |
| 6.2.12.4.30 | HEADER_SetBMPEX() .....            | 1401 |
| 6.2.12.4.31 | HEADER_SetBorderH() .....          | 1402 |
| 6.2.12.4.32 | HEADER_SetBorderV() .....          | 1403 |
| 6.2.12.4.33 | HEADER_SetDefaultBkColor() .....   | 1404 |
| 6.2.12.4.34 | HEADER_SetDefaultBorderH() .....   | 1405 |
| 6.2.12.4.35 | HEADER_SetDefaultBorderV() .....   | 1406 |
| 6.2.12.4.36 | HEADER_SetDefaultCursor() .....    | 1407 |
| 6.2.12.4.37 | HEADER_SetDefaultFont() .....      | 1408 |
| 6.2.12.4.38 | HEADER_SetDefaultTextColor() ..... | 1409 |
| 6.2.12.4.39 | HEADER_SetDragLimit() .....        | 1410 |
| 6.2.12.4.40 | HEADER_SetFixed() .....            | 1411 |
| 6.2.12.4.41 | HEADER_SetFont() .....             | 1412 |
| 6.2.12.4.42 | HEADER_SetHeight() .....           | 1413 |
| 6.2.12.4.43 | HEADER_SetItemText() .....         | 1414 |
| 6.2.12.4.44 | HEADER_SetItemWidth() .....        | 1415 |
| 6.2.12.4.45 | HEADER_SetScrollPos() .....        | 1416 |
| 6.2.12.4.46 | HEADER_SetStreamedBitmap() .....   | 1417 |
| 6.2.12.4.47 | HEADER_SetStreamedBitmapEx() ..... | 1418 |
| 6.2.12.4.48 | HEADER_SetTextAlign() .....        | 1419 |
| 6.2.12.4.49 | HEADER_SetTextColor() .....        | 1420 |
| 6.2.12.4.50 | HEADER_SetUserData() .....         | 1421 |
| 6.2.12.5    | Example .....                      | 1422 |
| 6.2.13      | ICONVIEW: Icon view widget .....   | 1423 |
| 6.2.13.1    | Configuration options .....        | 1423 |
| 6.2.13.2    | Predefined IDs .....               | 1424 |
| 6.2.13.3    | Notification codes .....           | 1424 |
| 6.2.13.4    | Keyboard reaction .....            | 1424 |

|            |  |      |
|------------|--|------|
| 6.2.13.5   | ICONVIEW API .....                           | 1425 |
| 6.2.13.5.1 | Functions .....                              | 1427 |
| 6.2.13.5.2 | Defines .....                                | 1462 |
| 6.2.13.6   | Example .....                                | 1465 |
| 6.2.14     | IMAGE: Image widget .....                    | 1466 |
| 6.2.14.1   | Configuration options .....                  | 1466 |
| 6.2.14.2   | Predefined IDs .....                         | 1466 |
| 6.2.14.3   | Notification codes .....                     | 1466 |
| 6.2.14.4   | IMAGE API .....                              | 1467 |
| 6.2.14.4.1 | Functions .....                              | 1468 |
| 6.2.14.4.2 | Defines .....                                | 1484 |
| 6.2.15     | KEYBOARD: Keyboard widget .....              | 1485 |
| 6.2.15.1   | Configuration options .....                  | 1485 |
| 6.2.15.2   | Predefined IDs .....                         | 1486 |
| 6.2.15.3   | Keyboard reaction .....                      | 1486 |
| 6.2.15.4   | Predefined keyboard layouts .....            | 1486 |
| 6.2.15.5   | Structure and definition of the widget ..... | 1487 |
| 6.2.15.5.1 | Key lines .....                              | 1487 |
| 6.2.15.5.2 | Keys .....                                   | 1487 |
| 6.2.15.5.3 | Long press characters .....                  | 1488 |
| 6.2.15.6   | Import and export of layouts .....           | 1489 |
| 6.2.15.7   | KEYBOARD API .....                           | 1490 |
| 6.2.15.7.1 | Functions .....                              | 1491 |
| 6.2.15.7.2 | Data structures .....                        | 1502 |
| 6.2.15.7.3 | Defines .....                                | 1511 |
| 6.2.16     | LISTBOX: List box widget .....               | 1514 |
| 6.2.16.1   | Configuration options .....                  | 1514 |
| 6.2.16.2   | Predefined IDs .....                         | 1514 |
| 6.2.16.3   | Notification codes .....                     | 1514 |
| 6.2.16.4   | Keyboard reaction .....                      | 1515 |
| 6.2.16.5   | LISTBOX API .....                            | 1515 |
| 6.2.16.5.1 | Functions .....                              | 1518 |
| 6.2.16.5.2 | Defines .....                                | 1577 |
| 6.2.16.6   | Examples .....                               | 1579 |
| 6.2.17     | LISTVIEW: Listview widget .....              | 1580 |
| 6.2.17.1   | Configuration options .....                  | 1581 |
| 6.2.17.2   | Predefined IDs .....                         | 1581 |
| 6.2.17.3   | Notification codes .....                     | 1582 |
| 6.2.17.4   | Keyboard reaction .....                      | 1582 |
| 6.2.17.5   | LISTVIEW API .....                           | 1582 |
| 6.2.17.5.1 | Functions .....                              | 1586 |
| 6.2.17.5.2 | Defines .....                                | 1673 |
| 6.2.17.6   | Example .....                                | 1674 |
| 6.2.18     | MENU: Menu widget .....                      | 1675 |
| 6.2.18.1   | Menu messages .....                          | 1676 |
| 6.2.18.1.1 | WM_MENU .....                                | 1676 |
| 6.2.18.2   | Configuration options .....                  | 1676 |
| 6.2.18.3   | Keyboard reaction .....                      | 1677 |
| 6.2.18.4   | MENU API .....                               | 1678 |
| 6.2.18.4.1 | Functions .....                              | 1680 |
| 6.2.18.4.2 | Data structures .....                        | 1716 |
| 6.2.18.4.3 | Defines .....                                | 1718 |
| 6.2.18.5   | Example .....                                | 1723 |
| 6.2.19     | MULTIEDIT: Multi line text widget .....      | 1724 |
| 6.2.19.1   | Configuration options .....                  | 1724 |
| 6.2.19.2   | Predefined IDs .....                         | 1726 |
| 6.2.19.3   | Notification codes .....                     | 1726 |
| 6.2.19.4   | Keyboard reaction .....                      | 1726 |
| 6.2.19.5   | MULTIEDIT API .....                          | 1727 |
| 6.2.19.5.1 | Functions .....                              | 1730 |

|             |                                       |      |
|-------------|---------------------------------------|------|
| 6.2.19.5.2  | Defines .....                         | 1787 |
| 6.2.19.6    | Example .....                         | 1790 |
| 6.2.20      | MULTIPAGE: Multiple page widget ..... | 1791 |
| 6.2.20.1    | Configuration options .....           | 1792 |
| 6.2.20.2    | Predefined IDs .....                  | 1792 |
| 6.2.20.3    | Notification codes .....              | 1793 |
| 6.2.20.4    | Keyboard reaction .....               | 1793 |
| 6.2.20.5    | MULTIPAGE API .....                   | 1793 |
| 6.2.20.5.1  | Functions .....                       | 1796 |
| 6.2.20.5.2  | Defines .....                         | 1840 |
| 6.2.20.6    | Example .....                         | 1844 |
| 6.2.21      | PROGBAR: Progress bar widget .....    | 1845 |
| 6.2.21.1    | Configuration options .....           | 1845 |
| 6.2.21.2    | Predefined IDs .....                  | 1845 |
| 6.2.21.3    | Notification codes .....              | 1845 |
| 6.2.21.4    | Keyboard reaction .....               | 1845 |
| 6.2.21.5    | PROGBAR API .....                     | 1846 |
| 6.2.21.5.1  | Functions .....                       | 1847 |
| 6.2.21.5.2  | Defines .....                         | 1867 |
| 6.2.21.6    | Examples .....                        | 1868 |
| 6.2.22      | QRCODE: QR code widget .....          | 1869 |
| 6.2.22.1    | Configuration options .....           | 1869 |
| 6.2.22.2    | Predefined IDs .....                  | 1869 |
| 6.2.22.3    | Keyboard reaction .....               | 1869 |
| 6.2.22.4    | QRCODE API .....                      | 1870 |
| 6.2.22.4.1  | Functions .....                       | 1871 |
| 6.2.22.4.2  | Defines .....                         | 1878 |
| 6.2.23      | RADIO: Radio button widget .....      | 1879 |
| 6.2.23.1    | Configuration options .....           | 1879 |
| 6.2.23.2    | Predefined IDs .....                  | 1880 |
| 6.2.23.3    | Notification codes .....              | 1880 |
| 6.2.23.4    | Keyboard reaction .....               | 1880 |
| 6.2.23.5    | RADIO API .....                       | 1881 |
| 6.2.23.5.1  | Functions .....                       | 1883 |
| 6.2.23.5.2  | Defines .....                         | 1915 |
| 6.2.23.6    | Examples .....                        | 1916 |
| 6.2.24      | ROTARY: Rotary widget .....           | 1917 |
| 6.2.24.1    | Configuration options .....           | 1917 |
| 6.2.24.2    | Predefined IDs .....                  | 1918 |
| 6.2.24.3    | Notification codes .....              | 1918 |
| 6.2.24.4    | Keyboard reaction .....               | 1918 |
| 6.2.24.5    | ROTARY API .....                      | 1919 |
| 6.2.24.5.1  | ROTARY_AddAngle() .....               | 1920 |
| 6.2.24.5.2  | ROTARY_AddValue() .....               | 1921 |
| 6.2.24.5.3  | ROTARY_CreateEx() .....               | 1922 |
| 6.2.24.5.4  | ROTARY_CreateIndirect() .....         | 1923 |
| 6.2.24.5.5  | ROTARY_CreateUser() .....             | 1924 |
| 6.2.24.5.6  | ROTARY_GetAngle() .....               | 1925 |
| 6.2.24.5.7  | ROTARY_GetImageSize() .....           | 1926 |
| 6.2.24.5.8  | ROTARY_GetMarkerSize() .....          | 1927 |
| 6.2.24.5.9  | ROTARY_GetUserData() .....            | 1928 |
| 6.2.24.5.10 | ROTARY_GetValue() .....               | 1929 |
| 6.2.24.5.11 | ROTARY_SetAngle() .....               | 1930 |
| 6.2.24.5.12 | ROTARY_SetBitmap() .....              | 1931 |
| 6.2.24.5.13 | ROTARY_SetDoRotate() .....            | 1932 |
| 6.2.24.5.14 | ROTARY_SetMarker() .....              | 1933 |
| 6.2.24.5.15 | ROTARY_SetOffset() .....              | 1934 |
| 6.2.24.5.16 | ROTARY_SetPeriod() .....              | 1935 |
| 6.2.24.5.17 | ROTARY_SetRadius() .....              | 1936 |
| 6.2.24.5.18 | ROTARY_SetRange() .....               | 1937 |

|             |  |      |
|-------------|--|------|
| 6.2.24.5.19 | ROTARY_SetSnap()                             | 1938 |
| 6.2.24.5.20 | ROTARY_SetTickSize()                         | 1939 |
| 6.2.24.5.21 | ROTARY_SetUserData()                         | 1940 |
| 6.2.24.5.22 | ROTARY_SetValue()                            | 1941 |
| 6.2.24.5.23 | ROTARY_SetValueRange()                       | 1942 |
| 6.2.25      | SCROLLER: Scroll widget                      | 1943 |
| 6.2.25.1    | Structure of the SCROLLER widget             | 1944 |
| 6.2.25.2    | Configuration options                        | 1945 |
| 6.2.25.3    | Predefined IDs                               | 1945 |
| 6.2.25.4    | Notification codes                           | 1946 |
| 6.2.25.5    | Widget behavior                              | 1946 |
| 6.2.25.6    | Attaching SCROLLERS to widgets               | 1947 |
| 6.2.25.7    | Attaching SCROLLERS to custom widgets        | 1948 |
| 6.2.25.8    | SCROLLER API                                 | 1952 |
| 6.2.25.8.1  | Functions                                    | 1955 |
| 6.2.25.8.2  | Data structures                              | 2014 |
| 6.2.25.8.3  | Defines                                      | 2015 |
| 6.2.26      | SLIDER: Slider widget                        | 2020 |
| 6.2.26.1    | Configuration options                        | 2020 |
| 6.2.26.2    | Predefined IDs                               | 2020 |
| 6.2.26.3    | Notification codes                           | 2021 |
| 6.2.26.3.1  | Keyboard reaction                            | 2021 |
| 6.2.26.4    | SLIDER API                                   | 2021 |
| 6.2.26.4.1  | Functions                                    | 2023 |
| 6.2.26.4.2  | Defines                                      | 2044 |
| 6.2.26.5    | Example                                      | 2045 |
| 6.2.27      | SPINBOX: Spinning box widget                 | 2046 |
| 6.2.27.1    | Configuration options                        | 2046 |
| 6.2.27.2    | Predefined IDs                               | 2047 |
| 6.2.27.3    | Notification codes                           | 2047 |
| 6.2.27.4    | Keyboard reaction                            | 2048 |
| 6.2.27.5    | SPINBOX API                                  | 2048 |
| 6.2.27.5.1  | Functions                                    | 2050 |
| 6.2.27.5.2  | Defines                                      | 2076 |
| 6.2.27.6    | Example                                      | 2080 |
| 6.2.28      | SWIPELIST: Swipelists widget                 | 2081 |
| 6.2.28.1    | Structure of the SWIPELIST widget            | 2081 |
| 6.2.28.2    | Difference between separator items and items | 2083 |
| 6.2.28.3    | Configuration options                        | 2083 |
| 6.2.28.4    | Predefined IDs                               | 2084 |
| 6.2.28.5    | Notification codes                           | 2085 |
| 6.2.28.6    | SWIPELIST API                                | 2085 |
| 6.2.28.6.1  | Functions                                    | 2088 |
| 6.2.28.6.2  | Defines                                      | 2158 |
| 6.2.28.7    | Examples                                     | 2164 |
| 6.2.29      | SWITCH: Switch widget                        | 2165 |
| 6.2.29.1    | Configuration options                        | 2165 |
| 6.2.29.2    | Predefined IDs                               | 2165 |
| 6.2.29.3    | Notification codes                           | 2165 |
| 6.2.29.4    | SWITCH API                                   | 2166 |
| 6.2.29.4.1  | Functions                                    | 2168 |
| 6.2.29.4.2  | Defines                                      | 2189 |
| 6.2.30      | TEXT: Text widget                            | 2194 |
| 6.2.30.1    | Configuration options                        | 2194 |
| 6.2.30.2    | Predefined IDs                               | 2194 |
| 6.2.30.3    | Notification codes                           | 2195 |
| 6.2.30.4    | Keyboard reaction                            | 2195 |
| 6.2.30.5    | TEXT API                                     | 2195 |
| 6.2.30.5.1  | Functions                                    | 2197 |
| 6.2.30.5.2  | Defines                                      | 2234 |

|            |   |      |
|------------|---|------|
| 6.2.30.6   | Examples .....                                | 2235 |
| 6.2.31     | TREEVIEW: Treeview widget .....               | 2236 |
| 6.2.31.1   | Description of terms .....                    | 2237 |
| 6.2.31.2   | Configuration options .....                   | 2237 |
| 6.2.31.3   | Predefined IDs .....                          | 2238 |
| 6.2.31.4   | Notification codes .....                      | 2238 |
| 6.2.31.5   | Keyboard reaction .....                       | 2239 |
| 6.2.31.6   | TREEVIEW API .....                            | 2239 |
| 6.2.31.6.1 | Common routines .....                         | 2242 |
| 6.2.31.6.2 | Item related routines .....                   | 2276 |
| 6.2.31.6.3 | Data structures .....                         | 2289 |
| 6.2.31.6.4 | Defines .....                                 | 2290 |
| 6.2.31.7   | Example .....                                 | 2297 |
| 6.2.32     | WHEEL: Wheel widget .....                     | 2298 |
| 6.2.32.1   | Structure of the WHEEL widget .....           | 2298 |
| 6.2.32.2   | Configuration options .....                   | 2300 |
| 6.2.32.3   | Predefined IDs .....                          | 2300 |
| 6.2.32.4   | Notification codes .....                      | 2300 |
| 6.2.32.5   | WHEEL API .....                               | 2300 |
| 6.2.32.5.1 | Functions .....                               | 2303 |
| 6.2.32.5.2 | Defines .....                                 | 2346 |
| 6.2.33     | WINDOW: Window widget .....                   | 2349 |
| 6.2.33.1   | Configuration options .....                   | 2349 |
| 6.2.33.2   | Keyboard reaction .....                       | 2349 |
| 6.2.33.3   | WINDOW API .....                              | 2349 |
| 6.2.33.3.1 | WINDOW_CreateEx() .....                       | 2350 |
| 6.2.33.3.2 | WINDOW_CreateIndirect() .....                 | 2351 |
| 6.2.33.3.3 | WINDOW_CreateUser() .....                     | 2352 |
| 6.2.33.3.4 | WINDOW_GetUserData() .....                    | 2353 |
| 6.2.33.3.5 | WINDOW_SetBkColor() .....                     | 2354 |
| 6.2.33.3.6 | WINDOW_SetDefaultBkColor() .....              | 2355 |
| 6.2.33.3.7 | WINDOW_SetUserData() .....                    | 2356 |
| 6.2.34     | Obsolete widgets .....                        | 2357 |
| 6.2.34.1   | KNOB: Knob widget (obsolete) .....            | 2357 |
| 6.2.34.1.1 | Requirements .....                            | 2357 |
| 6.2.34.1.2 | Configuration options .....                   | 2358 |
| 6.2.34.1.3 | Predefined IDs .....                          | 2358 |
| 6.2.34.1.4 | Notification codes .....                      | 2358 |
| 6.2.34.1.5 | Keyboard reaction .....                       | 2358 |
| 6.2.34.1.6 | KNOB API .....                                | 2359 |
| 6.2.34.2   | LISTWHEEL: Listwheel widget (obsolete) .....  | 2379 |
| 6.2.34.2.1 | Configuration options .....                   | 2379 |
| 6.2.34.2.2 | Predefined IDs .....                          | 2380 |
| 6.2.34.2.3 | Notification codes .....                      | 2380 |
| 6.2.34.2.4 | Keyboard reaction .....                       | 2380 |
| 6.2.34.2.5 | LISTWHEEL API .....                           | 2381 |
| 6.2.34.3   | SCROLLBAR: Scroll bar widget (obsolete) ..... | 2421 |
| 6.2.34.3.1 | Configuration options .....                   | 2421 |
| 6.2.34.3.2 | Predefined IDs .....                          | 2421 |
| 6.2.34.3.3 | Notification codes .....                      | 2422 |
| 6.2.34.3.4 | Keyboard reaction .....                       | 2422 |
| 6.2.34.3.5 | SCROLLBAR API .....                           | 2423 |
| 6.2.34.3.6 | Example .....                                 | 2451 |
| 6.3        | Dialogs .....                                 | 2452 |
| 6.3.1      | Dialog basics .....                           | 2452 |
| 6.3.2      | Creating a dialog .....                       | 2453 |
| 6.3.2.1    | Resource table .....                          | 2453 |
| 6.3.2.2    | Dialog procedure .....                        | 2453 |
| 6.3.2.2.1  | Initializing the dialog .....                 | 2454 |
| 6.3.2.3    | Defining dialog behavior .....                | 2455 |



|           |   |      |
|-----------|---|------|
| 6.3.3     | Dialog API .....                                    | 2456 |
| 6.3.3.1   | GUI_CreateDialogBox() .....                         | 2457 |
| 6.3.3.2   | GUI_ExecCreatedDialog() .....                       | 2458 |
| 6.3.3.3   | GUI_ExecDialogBox() .....                           | 2459 |
| 6.3.3.4   | GUI_EndDialog() .....                               | 2460 |
| 6.3.4     | CALENDAR dialog .....                               | 2461 |
| 6.3.4.1   | Notification codes .....                            | 2461 |
| 6.3.4.2   | Keyboard reaction .....                             | 2461 |
| 6.3.4.3   | CALENDAR_API .....                                  | 2462 |
| 6.3.4.3.1 | Functions .....                                     | 2463 |
| 6.3.4.3.2 | Data structures .....                               | 2478 |
| 6.3.4.3.3 | Defines .....                                       | 2479 |
| 6.3.5     | CHOOSECOLOR dialog .....                            | 2482 |
| 6.3.5.1   | Notification codes .....                            | 2482 |
| 6.3.5.2   | Keyboard reaction .....                             | 2482 |
| 6.3.5.3   | CHOOSECOLOR API .....                               | 2483 |
| 6.3.5.3.1 | Functions .....                                     | 2484 |
| 6.3.5.3.2 | Defines .....                                       | 2491 |
| 6.3.6     | CHOOSEFILE dialog .....                             | 2492 |
| 6.3.6.1   | Configuring options .....                           | 2492 |
| 6.3.6.2   | Keyboard reaction .....                             | 2492 |
| 6.3.6.3   | Path- and file names .....                          | 2492 |
| 6.3.6.4   | CHOOSEFILE API .....                                | 2493 |
| 6.3.6.4.1 | Functions .....                                     | 2494 |
| 6.3.6.4.2 | Data structures .....                               | 2503 |
| 6.3.6.4.3 | CHOOSEFILE_INFO .....                               | 2503 |
| 6.3.6.4.4 | Defines .....                                       | 2505 |
| 6.3.7     | MESSAGEBOX dialog .....                             | 2506 |
| 6.3.7.1   | Configuration options .....                         | 2506 |
| 6.3.7.2   | Keyboard reaction .....                             | 2506 |
| 6.3.7.3   | MESSAGEBOX API .....                                | 2506 |
| 6.3.7.3.1 | GUI_MessageBox() .....                              | 2507 |
| 6.3.7.3.2 | MESSAGEBOX_Create() .....                           | 2508 |
| 6.4       | Skinning .....                                      | 2509 |
| 6.4.1     | What is a 'skin' .....                              | 2509 |
| 6.4.2     | From using API functions to skinning .....          | 2509 |
| 6.4.3     | Skinnable widgets .....                             | 2511 |
| 6.4.4     | Using a skin .....                                  | 2511 |
| 6.4.4.1   | Runtime configuration .....                         | 2512 |
| 6.4.4.2   | Compile-time configuration .....                    | 2512 |
| 6.4.5     | Simple changes to the look of the 'Flex' skin ..... | 2512 |
| 6.4.6     | Major changes to the 'Flex' skin .....              | 2513 |
| 6.4.6.1   | The skinning callback mechanism .....               | 2513 |
| 6.4.6.2   | Changing the look of the default skin .....         | 2513 |
| 6.4.6.3   | List of commands .....                              | 2515 |
| 6.4.7     | General Skinning API .....                          | 2516 |
| 6.4.7.1   | <WIDGET>_DrawSkinFlex() .....                       | 2517 |
| 6.4.7.2   | <WIDGET>_GetSkinFlexProps() .....                   | 2518 |
| 6.4.7.3   | <WIDGET>_SetDefaultSkin() .....                     | 2519 |
| 6.4.7.4   | <WIDGET>_SetDefaultSkinClassic() .....              | 2520 |
| 6.4.7.5   | <WIDGET>_SetSkin() .....                            | 2521 |
| 6.4.7.6   | <WIDGET>_SetSkinClassic() .....                     | 2522 |
| 6.4.7.7   | <WIDGET>_SetSkinFlexProps() .....                   | 2523 |
| 6.4.8     | BUTTON_SKIN_FLEX .....                              | 2524 |
| 6.4.8.1   | Configuration structure .....                       | 2524 |
| 6.4.8.2   | Configuration options .....                         | 2525 |
| 6.4.8.3   | Skinning API .....                                  | 2525 |
| 6.4.8.3.1 | BUTTON_SetSkinFlexProps() .....                     | 2526 |
| 6.4.8.4   | List of commands .....                              | 2527 |
| 6.4.8.4.1 | WIDGET_ITEM_CREATE .....                            | 2527 |

|            |  |      |
|------------|--|------|
| 6.4.8.4.2  | WIDGET_ITEM_DRAW_BACKGROUND .....      | 2527 |
| 6.4.8.4.3  | WIDGET_ITEM_DRAW_BITMAP .....          | 2527 |
| 6.4.8.4.4  | WIDGET_ITEM_DRAW_TEXT .....            | 2528 |
| 6.4.9      | CHECKBOX_SKIN_FLEX .....               | 2529 |
| 6.4.9.1    | Configuration structure .....          | 2529 |
| 6.4.9.2    | Configuration options .....            | 2530 |
| 6.4.9.3    | Skinning API .....                     | 2530 |
| 6.4.9.3.1  | CHECKBOX_GetSkinFlexButtonSize() ..... | 2531 |
| 6.4.9.3.2  | CHECKBOX_SetSkinFlexButtonSize() ..... | 2532 |
| 6.4.9.3.3  | CHECKBOX_SetSkinFlexProps() .....      | 2533 |
| 6.4.9.4    | List of commands .....                 | 2534 |
| 6.4.9.4.1  | WIDGET_ITEM_CREATE .....               | 2534 |
| 6.4.9.4.2  | WIDGET_ITEM_DRAW_BUTTON .....          | 2534 |
| 6.4.9.4.3  | WIDGET_ITEM_DRAW_BITMAP .....          | 2534 |
| 6.4.9.4.4  | WIDGET_ITEM_DRAW_FOCUS .....           | 2535 |
| 6.4.9.4.5  | WIDGET_ITEM_DRAW_TEXT .....            | 2535 |
| 6.4.10     | DROPDOWN_SKIN_FLEX .....               | 2536 |
| 6.4.10.1   | Configuration structure .....          | 2536 |
| 6.4.10.2   | Configuration options .....            | 2537 |
| 6.4.10.3   | Skinning API .....                     | 2537 |
| 6.4.10.3.1 | DROPDOWN_SetSkinFlexProps() .....      | 2538 |
| 6.4.10.4   | List of commands .....                 | 2539 |
| 6.4.10.4.1 | WIDGET_ITEM_CREATE .....               | 2539 |
| 6.4.10.4.2 | WIDGET_ITEM_DRAW_ARROW .....           | 2539 |
| 6.4.10.4.3 | WIDGET_ITEM_DRAW_BACKGROUND .....      | 2539 |
| 6.4.10.4.4 | WIDGET_ITEM_DRAW_TEXT .....            | 2539 |
| 6.4.11     | FRAMEWIN_SKIN_FLEX .....               | 2540 |
| 6.4.11.1   | Configuration structure .....          | 2540 |
| 6.4.11.2   | Configuration options .....            | 2541 |
| 6.4.11.3   | Skinning API .....                     | 2541 |
| 6.4.11.3.1 | FRAMEWIN_SetSkinFlexProps() .....      | 2542 |
| 6.4.11.4   | List of commands .....                 | 2543 |
| 6.4.11.4.1 | WIDGET_ITEM_CREATE .....               | 2543 |
| 6.4.11.4.2 | WIDGET_ITEM_DRAW_BACKGROUND .....      | 2543 |
| 6.4.11.4.3 | WIDGET_ITEM_DRAW_FRAME .....           | 2544 |
| 6.4.11.4.4 | WIDGET_ITEM_DRAW_TEXT .....            | 2544 |
| 6.4.11.4.5 | WIDGET_ITEM_GET_BORDERSIZE_L .....     | 2544 |
| 6.4.11.4.6 | WIDGET_ITEM_GET_BORDERSIZE_R .....     | 2544 |
| 6.4.11.4.7 | WIDGET_ITEM_GET_BORDERSIZE_T .....     | 2544 |
| 6.4.11.4.8 | WIDGET_ITEM_GET_BORDERSIZE_B .....     | 2544 |
| 6.4.12     | HEADER_SKIN_FLEX .....                 | 2545 |
| 6.4.12.1   | Configuration structure .....          | 2545 |
| 6.4.12.2   | Configuration options .....            | 2545 |
| 6.4.12.3   | Skinning API .....                     | 2546 |
| 6.4.12.3.1 | HEADER_SetSkinFlexProps() .....        | 2547 |
| 6.4.12.4   | List of commands .....                 | 2548 |
| 6.4.12.4.1 | WIDGET_ITEM_CREATE .....               | 2548 |
| 6.4.12.4.2 | WIDGET_ITEM_DRAW_ARROW .....           | 2548 |
| 6.4.12.4.3 | WIDGET_ITEM_DRAW_BACKGROUND .....      | 2548 |
| 6.4.12.4.4 | WIDGET_ITEM_DRAW_BITMAP .....          | 2548 |
| 6.4.12.4.5 | WIDGET_ITEM_DRAW_OVERLAP .....         | 2549 |
| 6.4.12.4.6 | Widget_ITEM_DRAW_TEXT .....            | 2549 |
| 6.4.13     | MENU_SKIN_FLEX .....                   | 2550 |
| 6.4.13.1   | Configuration structure .....          | 2551 |
| 6.4.13.2   | Configuration options .....            | 2552 |
| 6.4.13.3   | Skinning API .....                     | 2552 |
| 6.4.13.3.1 | MENU_SetSkinFlexProps() .....          | 2553 |
| 6.4.13.3.2 | MENU_SkinEnableArrow() .....           | 2554 |
| 6.4.13.4   | List of commands .....                 | 2555 |
| 6.4.13.4.1 | WIDGET_ITEM_CREATE .....               | 2555 |

|            |                                    |      |
|------------|------------------------------------|------|
| 6.4.13.4.2 | WIDGET_ITEM_DRAW_ARROW .....       | 2555 |
| 6.4.13.4.3 | WIDGET_ITEM_DRAW_BACKGROUND .....  | 2556 |
| 6.4.13.4.4 | WIDGET_ITEM_DRAW_FRAME .....       | 2556 |
| 6.4.13.4.5 | WIDGET_ITEM_DRAW_TEXT .....        | 2556 |
| 6.4.14     | MULTIPAGE_SKIN_FLEX .....          | 2557 |
| 6.4.14.1   | Configuration structure .....      | 2557 |
| 6.4.14.2   | Configuration options .....        | 2558 |
| 6.4.14.3   | Skinning API .....                 | 2558 |
| 6.4.14.3.1 | MULTIPAGE_SetSkinFlexProps() ..... | 2559 |
| 6.4.14.4   | List of commands .....             | 2560 |
| 6.4.14.4.1 | WIDGET_ITEM_CREATE .....           | 2561 |
| 6.4.14.4.2 | WIDGET_ITEM_DRAW_BACKGROUND .....  | 2561 |
| 6.4.14.4.3 | WIDGET_ITEM_DRAW_FRAME .....       | 2561 |
| 6.4.14.4.4 | WIDGET_ITEM_DRAW_TEXT .....        | 2561 |
| 6.4.15     | PROGBAR_SKIN_FLEX .....            | 2562 |
| 6.4.15.1   | Configuration structure .....      | 2562 |
| 6.4.15.2   | Configuration options .....        | 2563 |
| 6.4.15.3   | Skinning API .....                 | 2563 |
| 6.4.15.3.1 | PROGBAR_SetSkinFlexProps() .....   | 2564 |
| 6.4.15.4   | List of commands .....             | 2565 |
| 6.4.15.4.1 | WIDGET_ITEM_CREATE .....           | 2565 |
| 6.4.15.4.2 | WIDGET_ITEM_DRAW_BACKGROUND .....  | 2565 |
| 6.4.15.4.3 | WIDGET_ITEM_DRAW_FRAME .....       | 2566 |
| 6.4.15.4.4 | WIDGET_ITEM_DRAW_TEXT .....        | 2566 |
| 6.4.16     | RADIO_SKIN_FLEX .....              | 2567 |
| 6.4.16.1   | Configuration structure .....      | 2567 |
| 6.4.16.2   | Configuration options .....        | 2568 |
| 6.4.16.3   | Skinning API .....                 | 2568 |
| 6.4.16.3.1 | RADIO_SetSkinFlexProps() .....     | 2569 |
| 6.4.16.4   | List of commands .....             | 2570 |
| 6.4.16.4.1 | WIDGET_ITEM_DRAW_FOCUS .....       | 2571 |
| 6.4.16.4.2 | WIDGET_ITEM_DRAW_TEXT .....        | 2571 |
| 6.4.16.4.3 | WIDGET_ITEM_GET_BUTTONSIZE .....   | 2571 |
| 6.4.17     | SCROLLBAR_SKIN_FLEX .....          | 2572 |
| 6.4.17.1   | Configuration structure .....      | 2572 |
| 6.4.17.2   | Configuration options .....        | 2573 |
| 6.4.17.3   | Skinning API .....                 | 2573 |
| 6.4.17.3.1 | SCROLLBAR_SetSkinFlexProps() ..... | 2574 |
| 6.4.17.4   | List of commands .....             | 2575 |
| 6.4.17.4.1 | WIDGET_ITEM_DRAW_BUTTON_L .....    | 2575 |
| 6.4.17.4.2 | WIDGET_ITEM_DRAW_BUTTON_R .....    | 2575 |
| 6.4.17.4.3 | WIDGET_ITEM_DRAW_OVERLAP .....     | 2576 |
| 6.4.17.4.4 | WIDGET_ITEM_DRAW_SHAFT_L .....     | 2576 |
| 6.4.17.4.5 | WIDGET_ITEM_DRAW_SHAFT_R .....     | 2576 |
| 6.4.17.4.6 | WIDGET_ITEM_DRAW_THUMB .....       | 2577 |
| 6.4.17.4.7 | WIDGET_ITEM_GET_BUTTONSIZE .....   | 2577 |
| 6.4.18     | SLIDER_SKIN_FLEX .....             | 2578 |
| 6.4.18.1   | Configuration structure .....      | 2578 |
| 6.4.18.2   | Configuration options .....        | 2579 |
| 6.4.18.3   | Skinning API .....                 | 2579 |
| 6.4.18.3.1 | SLIDER_SetSkinFlexProps() .....    | 2580 |
| 6.4.18.4   | List of commands .....             | 2581 |
| 6.4.18.4.1 | WIDGET_ITEM_CREATE .....           | 2581 |
| 6.4.18.4.2 | WIDGET_ITEM_DRAW_FOCUS .....       | 2581 |
| 6.4.18.4.3 | WIDGET_ITEM_DRAW_SHAFT .....       | 2581 |
| 6.4.18.4.4 | WIDGET_ITEM_DRAW_THUMB .....       | 2582 |
| 6.4.18.4.5 | WIDGET_ITEM_DRAW_TICKS .....       | 2582 |
| 6.4.19     | SPINBOX_SKIN_FLEX .....            | 2583 |
| 6.4.19.1   | Configuration options .....        | 2584 |
| 6.4.19.2   | Skinning API .....                 | 2584 |

|            |  |      |
|------------|--|------|
| 6.4.19.2.1 | SPINBOX_SetSkinFlexProps()                         | 2585 |
| 6.4.19.3   | List of commands                                   | 2586 |
| 6.4.19.3.1 | WIDGET_ITEM_CREATE                                 | 2586 |
| 6.4.19.3.2 | WIDGET_ITEM_DRAW_BACKGROUND                        | 2586 |
| 6.4.19.3.3 | WIDGET_ITEM_DRAW_BUTTON_U                          | 2586 |
| 6.4.19.3.4 | WIDGET_ITEM_DRAW_BUTTON_D                          | 2587 |
| 6.5        | Anti-aliasing                                      | 2588 |
| 6.5.1      | Introduction                                       | 2588 |
| 6.5.2      | Quality of anti-aliasing                           | 2588 |
| 6.5.3      | Anti-aliased fonts                                 | 2589 |
| 6.5.3.1    | Character representation in font files             | 2589 |
| 6.5.3.2    | Gamma correction                                   | 2589 |
| 6.5.4      | High-resolution coordinates                        | 2590 |
| 6.5.5      | Anti-aliasing API                                  | 2592 |
| 6.5.5.1    | Control functions                                  | 2594 |
| 6.5.5.1.1  | GUI_AA_DisableHiRes()                              | 2594 |
| 6.5.5.1.2  | GUI_AA_EnableHiRes()                               | 2595 |
| 6.5.5.1.3  | GUI_AA_GetFactor()                                 | 2596 |
| 6.5.5.1.4  | GUI_AA_PreserveTrans()                             | 2597 |
| 6.5.5.1.5  | GUI_AA_SetBufferSize()                             | 2598 |
| 6.5.5.1.6  | GUI_AA_SetFactor()                                 | 2599 |
| 6.5.5.2    | Drawing functions                                  | 2600 |
| 6.5.5.2.1  | GUI_AA_DrawArc()                                   | 2600 |
| 6.5.5.2.2  | GUI_AA_DrawCircle()                                | 2601 |
| 6.5.5.2.3  | GUI_AA_DrawLine()                                  | 2602 |
| 6.5.5.2.4  | GUI_AA_DrawPie()                                   | 2603 |
| 6.5.5.2.5  | GUI_AA_DrawPolyOutline()                           | 2604 |
| 6.5.5.2.6  | GUI_AA_DrawPolyOutlineEx()                         | 2605 |
| 6.5.5.2.7  | GUI_AA_DrawRoundedFrame()                          | 2606 |
| 6.5.5.2.8  | GUI_AA_DrawRoundedFrameEx()                        | 2607 |
| 6.5.5.2.9  | GUI_AA_DrawRoundedRect()                           | 2608 |
| 6.5.5.2.10 | GUI_AA_DrawRoundedRectEx()                         | 2609 |
| 6.5.5.2.11 | GUI_AA_FillCircle()                                | 2610 |
| 6.5.5.2.12 | GUI_AA_FillEllipse()                               | 2611 |
| 6.5.5.2.13 | GUI_AA_FillEllipseXL()                             | 2612 |
| 6.5.5.2.14 | GUI_AA_FillPolygon()                               | 2613 |
| 6.5.5.2.15 | GUI_AA_FillRoundedRect()                           | 2614 |
| 6.5.5.2.16 | GUI_AA_FillRoundedRectEx()                         | 2615 |
| 6.5.5.2.17 | GUI_AA_SetDrawMode()                               | 2616 |
| 6.5.5.3    | Gamma correction                                   | 2617 |
| 6.5.5.3.1  | GUI_AA_EnableGammaAA4()                            | 2617 |
| 6.5.5.3.2  | GUI_AA_GetGammaAA4()                               | 2618 |
| 6.5.5.3.3  | GUI_AA_SetGammaAA4()                               | 2619 |
| 6.5.6      | Examples   | 2620 |
| 6.5.6.1    | Different anti-aliasing factors                    | 2620 |
| 6.5.6.2    | Lines placed on high-resolution coordinates        | 2622 |
| 6.5.6.3    | Moving pointer using high-resolution anti-aliasing | 2624 |
| 6.6        | Memory Devices                                     | 2626 |
| 6.6.1      | Using Memory Devices: Illustration                 | 2627 |
| 6.6.2      | Supported color depth (bpp)                        | 2628 |
| 6.6.3      | Memory Devices and the Window Manager              | 2628 |
| 6.6.4      | Memory Devices and multiple layers                 | 2629 |
| 6.6.5      | Memory requirements                                | 2630 |
| 6.6.6      | Performance  | 2631 |
| 6.6.7      | Basic functions                                    | 2631 |
| 6.6.8      | In order to be able to use Memory Devices...       | 2631 |
| 6.6.9      | MultiLayer / MultiDisplay configuration            | 2631 |
| 6.6.10     | Configuration options                              | 2631 |
| 6.6.11     | Memory Device API                                  | 2632 |
| 6.6.11.1   | Basic functions                                    | 2636 |

|             |   |      |
|-------------|---|------|
| 6.6.11.1.1  | GUI_MEMDEV_Clear()                        | 2636 |
| 6.6.11.1.2  | GUI_MEMDEV_ClearAlpha()                   | 2637 |
| 6.6.11.1.3  | GUI_MEMDEV_CopyFromLCD()                  | 2639 |
| 6.6.11.1.4  | GUI_MEMDEV_CopyToLCD()                    | 2640 |
| 6.6.11.1.5  | GUI_MEMDEV_CopyToLCDAA()                  | 2641 |
| 6.6.11.1.6  | GUI_MEMDEV_CopyToLCDAt()                  | 2642 |
| 6.6.11.1.7  | GUI_MEMDEV_Create()                       | 2643 |
| 6.6.11.1.8  | GUI_MEMDEV_CreateCopy()                   | 2644 |
| 6.6.11.1.9  | GUI_MEMDEV_CreateEx()                     | 2645 |
| 6.6.11.1.10 | GUI_MEMDEV_CreateFixed()                  | 2646 |
| 6.6.11.1.11 | GUI_MEMDEV_CreateFixed32()                | 2647 |
| 6.6.11.1.12 | GUI_MEMDEV_Delete()                       | 2648 |
| 6.6.11.1.13 | GUI_MEMDEV_DrawPerspectiveX()             | 2649 |
| 6.6.11.1.14 | GUI_MEMDEV_GetBitsPerPixel()              | 2651 |
| 6.6.11.1.15 | GUI_MEMDEV_GetDataPtr()                   | 2652 |
| 6.6.11.1.16 | GUI_MEMDEV_GetSelMemdev()                 | 2653 |
| 6.6.11.1.17 | GUI_MEMDEV_GetXSize()                     | 2654 |
| 6.6.11.1.18 | GUI_MEMDEV_GetYSize()                     | 2655 |
| 6.6.11.1.19 | GUI_MEMDEV_MarkDirty()                    | 2656 |
| 6.6.11.1.20 | GUI_MEMDEV_PunchOutDevice()               | 2657 |
| 6.6.11.1.21 | GUI_MEMDEV_ReduceYSize()                  | 2659 |
| 6.6.11.1.22 | GUI_MEMDEV_Rotate()                       | 2660 |
| 6.6.11.1.23 | GUI_MEMDEV_RotateAlpha()                  | 2660 |
| 6.6.11.1.24 | GUI_MEMDEV_RotateHQ()                     | 2660 |
| 6.6.11.1.25 | GUI_MEMDEV_RotateHQAlpha()                | 2660 |
| 6.6.11.1.26 | GUI_MEMDEV_RotateHQHR()                   | 2660 |
| 6.6.11.1.27 | GUI_MEMDEV_RotateHQT()                    | 2660 |
| 6.6.11.1.28 | GUI_MEMDEV_RotateHR()                     | 2660 |
| 6.6.11.1.29 | GUI_MEMDEV_Select()                       | 2665 |
| 6.6.11.1.30 | GUI_MEMDEV_SerializeBMP()                 | 2666 |
| 6.6.11.1.31 | GUI_MEMDEV_SerializeExBMP()               | 2667 |
| 6.6.11.1.32 | GUI_MEMDEV_SetOrg()                       | 2668 |
| 6.6.11.1.33 | GUI_MEMDEV_Write()                        | 2669 |
| 6.6.11.1.34 | GUI_MEMDEV_WriteAlpha()                   | 2670 |
| 6.6.11.1.35 | GUI_MEMDEV_WriteAlphaAt()                 | 2671 |
| 6.6.11.1.36 | GUI_MEMDEV_WriteAt()                      | 2672 |
| 6.6.11.1.37 | GUI_MEMDEV_WriteEx()                      | 2673 |
| 6.6.11.1.38 | GUI_MEMDEV_WriteExAt()                    | 2674 |
| 6.6.11.1.39 | GUI_MEMDEV_WriteOpaque()                  | 2675 |
| 6.6.11.1.40 | GUI_MEMDEV_WriteOpaqueAt()                | 2676 |
| 6.6.11.1.41 | GUI_SelectLCD()                           | 2677 |
| 6.6.11.2    | Example for using a Memory Device         | 2678 |
| 6.6.11.3    | Banding Memory Device                     | 2679 |
| 6.6.11.3.1  | GUI_MEMDEV_Draw()                         | 2679 |
| 6.6.11.3.2  | Example for using a banding Memory Device | 2680 |
| 6.6.11.4    | Auto device object functions              | 2681 |
| 6.6.11.4.1  | GUI_MEMDEV_CreateAuto()                   | 2681 |
| 6.6.11.4.2  | GUI_MEMDEV_DeleteAuto()                   | 2682 |
| 6.6.11.4.3  | GUI_MEMDEV_DrawAuto()                     | 2683 |
| 6.6.11.4.4  | Example for using an auto device object   | 2684 |
| 6.6.11.5    | Measurement device object functions       | 2685 |
| 6.6.11.5.1  | GUI_MEASDEV_ClearRect()                   | 2685 |
| 6.6.11.5.2  | GUI_MEASDEV_Create()                      | 2686 |
| 6.6.11.5.3  | GUI_MEASDEV_Delete()                      | 2687 |
| 6.6.11.5.4  | GUI_MEASDEV_GetRect()                     | 2688 |
| 6.6.11.5.5  | GUI_MEASDEV_Select()                      | 2689 |
| 6.6.11.6    | Animation functions                       | 2690 |
| 6.6.11.6.1  | GUI_MEMDEV_FadeInDevices()                | 2690 |
| 6.6.11.6.2  | GUI_MEMDEV_FadeOutDevices()               | 2691 |
| 6.6.11.6.3  | GUI_MEMDEV_SetAnimationCallback()         | 2692 |

|             |   |      |
|-------------|---|------|
| 6.6.11.6.4  | GUI_MEMDEV_SetTimePerFrame()                                  | 2693 |
| 6.6.11.7    | Animation functions (Window Manager required)                 | 2694 |
| 6.6.11.7.1  | GUI_MEMDEV_FadeInWindow()                                     | 2694 |
| 6.6.11.7.2  | GUI_MEMDEV_FadeOutWindow()                                    | 2694 |
| 6.6.11.7.3  | GUI_MEMDEV_MoveInWindow()                                     | 2695 |
| 6.6.11.7.4  | GUI_MEMDEV_MoveOutWindow()                                    | 2695 |
| 6.6.11.7.5  | GUI_MEMDEV_ShiftInWindow()                                    | 2697 |
| 6.6.11.7.6  | GUI_MEMDEV_ShiftOutWindow()                                   | 2697 |
| 6.6.11.7.7  | GUI_MEMDEV_SwapWindow()                                       | 2698 |
| 6.6.11.8    | Blending, Blurring and Dithering functions                    | 2699 |
| 6.6.11.8.1  | GUI_MEMDEV_BlendColor32()                                     | 2699 |
| 6.6.11.8.2  | GUI_MEMDEV_CreateBlurredDevice32()                            | 2700 |
| 6.6.11.8.3  | GUI_MEMDEV_CreateBlurredDevice32HQ()                          | 2702 |
| 6.6.11.8.4  | GUI_MEMDEV_CreateBlurredDevice32LQ()                          | 2703 |
| 6.6.11.8.5  | GUI_MEMDEV_Dither32()   | 2704 |
| 6.6.11.8.6  | GUI_MEMDEV_SetBlurHQ()  | 2705 |
| 6.6.11.8.7  | GUI_MEMDEV_SetBlurLQ()  | 2706 |
| 6.6.11.9    | Blending and Blurring functions (Window Manager required) ... | 2707 |
| 6.6.11.9.1  | GUI_MEMDEV_BlendWinBk()                                       | 2707 |
| 6.6.11.9.2  | GUI_MEMDEV_BlurAndBlendWinBk()                                | 2708 |
| 6.6.11.9.3  | GUI_MEMDEV_BlurWinBk()  | 2709 |
| 6.6.11.10   | Setting up multiple buffering for animation functions         | 2710 |
| 6.6.11.10.1 | GUI_MEMDEV_MULTIBUF_Enable()                                  | 2710 |
| 6.6.11.11   | Defines   | 2711 |
| 6.6.11.11.1 | Color conversion routines                                     | 2711 |
| 6.6.11.11.2 | Direction symbols   | 2712 |
| 6.6.11.11.3 | Memory device color depths                                    | 2713 |
| 6.6.11.11.4 | Memory device flags   | 2714 |
| 6.7         | MultiTouch support (MT)                                       | 2715 |
| 6.7.1       | Introduction  | 2715 |
| 6.7.2       | Getting started   | 2716 |
| 6.7.3       | Using basic buffer access                                     | 2717 |
| 6.7.4       | Using gestures  | 2719 |
| 6.7.5       | Window animation  | 2720 |
| 6.7.6       | Basic buffer access API                                       | 2721 |
| 6.7.6.1     | Functions   | 2722 |
| 6.7.6.1.1   | GUI_MTOUCH_Enable()   | 2722 |
| 6.7.6.1.2   | GUI_MTOUCH_GetEvent()   | 2723 |
| 6.7.6.1.3   | GUI_MTOUCH_GetTouchInput()                                    | 2724 |
| 6.7.6.1.4   | GUI_MTOUCH_IsEmpty()  | 2725 |
| 6.7.6.1.5   | GUI_MTOUCH_SetOrientation()                                   | 2726 |
| 6.7.6.1.6   | GUI_MTOUCH_StoreEvent()                                       | 2727 |
| 6.7.6.2     | Data structures   | 2728 |
| 6.7.6.2.1   | GUI_MTOUCH_EVENT  | 2728 |
| 6.7.6.2.2   | GUI_MTOUCH_INPUT  | 2729 |
| 6.7.6.2.3   | WM_GESTURE_INFO   | 2730 |
| 6.7.6.2.4   | WM_ZOOM_INFO  | 2731 |
| 6.7.6.3     | Defines   | 2732 |
| 6.7.6.3.1   | MultiTouch flags  | 2732 |
| 6.7.6.3.2   | MultiTouch gesture flags                                      | 2733 |
| 6.8         | VNC Server  | 2734 |
| 6.8.1       | Introduction  | 2735 |
| 6.8.1.1     | Filetransfer  | 2735 |
| 6.8.1.2     | Requirements  | 2735 |
| 6.8.1.3     | Notes on this implementation                                  | 2735 |
| 6.8.2       | emVNC client  | 2737 |
| 6.8.2.1     | How to connect to a VNC-server                                | 2737 |
| 6.8.2.2     | Opening the file transfer dialog                              | 2737 |
| 6.8.2.3     | The file transfer window                                      | 2738 |
| 6.8.2.4     | Connecting with a web browser                                 | 2739 |

|            |   |      |
|------------|---|------|
| 6.8.3      | emWin VNC server .....  | 2740 |
| 6.8.3.1    | Starting the emWin VNC server .....                           | 2740 |
| 6.8.3.2    | Enabling file transfer support .....                          | 2740 |
| 6.8.3.3    | Starting the VNC server in the simulation .....               | 2740 |
| 6.8.3.4    | Example of starting the VNC server on the target system ..... | 2740 |
| 6.8.4      | RAM and ROM requirements .....                                | 2740 |
| 6.8.5      | VNC Server API .....  | 2741 |
| 6.8.5.1    | Functions .....   | 2742 |
| 6.8.5.1.1  | GUI_VNC_AttachToLayer() .....                                 | 2742 |
| 6.8.5.1.2  | GUI_VNC_EnableFileTransfer() .....                            | 2743 |
| 6.8.5.1.3  | GUI_VNC_EnableKeyboardInput() .....                           | 2744 |
| 6.8.5.1.4  | GUI_VNC_GetNumConnections() .....                             | 2745 |
| 6.8.5.1.5  | GUI_VNC_Process() .....                                       | 2746 |
| 6.8.5.1.6  | GUI_VNC_RingBell() .....                                      | 2747 |
| 6.8.5.1.7  | GUI_VNC_SetFS_API() .....                                     | 2748 |
| 6.8.5.1.8  | GUI_VNC_SetLockFrame() .....                                  | 2749 |
| 6.8.5.1.9  | GUI_VNC_SetPassword() .....                                   | 2750 |
| 6.8.5.1.10 | GUI_VNC_SetProgName() .....                                   | 2751 |
| 6.8.5.1.11 | GUI_VNC_SetRetryCount() .....                                 | 2752 |
| 6.8.5.1.12 | GUI_VNC_SetSize() .....                                       | 2753 |
| 6.8.5.1.13 | GUI_VNC_X_StartServer() .....                                 | 2754 |
| 6.8.5.1.14 | GUI_VNC_X_StartServerFT() .....                               | 2755 |
| 6.8.5.2    | Data structures .....   | 2756 |
| 6.8.5.2.1  | IP_FS_API .....   | 2756 |
| 7          | Legacy features .....   | 2758 |
| 7.1        | Sprites .....   | 2759 |
| 7.1.1      | Introduction .....  | 2759 |
| 7.1.2      | Sprite API .....  | 2760 |
| 7.1.2.1    | GUI_SPRITE_Create() .....                                     | 2761 |
| 7.1.2.2    | GUI_SPRITE_CreateAnim() .....                                 | 2762 |
| 7.1.2.3    | GUI_SPRITE_CreateEx() .....                                   | 2763 |
| 7.1.2.4    | GUI_SPRITE_CreateExAnim() .....                               | 2764 |
| 7.1.2.5    | GUI_SPRITE_CreateHidden() .....                               | 2765 |
| 7.1.2.6    | GUI_SPRITE_CreateHiddenEx() .....                             | 2766 |
| 7.1.2.7    | GUI_SPRITE_Delete() .....                                     | 2767 |
| 7.1.2.8    | GUI_SPRITE_GetState() .....                                   | 2768 |
| 7.1.2.9    | GUI_SPRITE_Hide() .....                                       | 2769 |
| 7.1.2.10   | GUI_SPRITE_SetBitmap() .....                                  | 2770 |
| 7.1.2.11   | GUI_SPRITE_SetBitmapAndPosition() .....                       | 2771 |
| 7.1.2.12   | GUI_SPRITE_SetLoop() .....                                    | 2772 |
| 7.1.2.13   | GUI_SPRITE_SetPosition() .....                                | 2773 |
| 7.1.2.14   | GUI_SPRITE_Show() .....                                       | 2774 |
| 7.1.2.15   | GUI_SPRITE_StartAnim() .....                                  | 2775 |
| 7.1.2.16   | GUI_SPRITE_StopAnim() .....                                   | 2776 |
| 7.2        | Cursors .....   | 2777 |
| 7.2.1      | Available cursors .....                                       | 2777 |
| 7.2.2      | Cursor API .....  | 2778 |
| 7.2.2.1    | Functions .....   | 2779 |
| 7.2.2.1.1  | GUI_CURSOR_GetState() .....                                   | 2779 |
| 7.2.2.1.2  | GUI_CURSOR_Hide() .....                                       | 2780 |
| 7.2.2.1.3  | GUI_CURSOR_Select() .....                                     | 2781 |
| 7.2.2.1.4  | GUI_CURSOR_SelectAnim() .....                                 | 2782 |
| 7.2.2.1.5  | GUI_CURSOR_SetPosition() .....                                | 2783 |
| 7.2.2.1.6  | GUI_CURSOR_Show() .....                                       | 2784 |
| 7.2.2.2    | Data structures .....   | 2785 |
| 7.2.2.2.1  | GUI_CURSOR_ANIM .....   | 2785 |
| 7.3        | Virtual screens / Virtual pages .....                         | 2786 |
| 7.3.1      | Introduction .....  | 2786 |

|           |  |      |
|-----------|--|------|
| 7.3.2     | Requirements .....                               | 2787 |
| 7.3.3     | Configuration .....                              | 2787 |
| 7.3.3.1   | LCD_SetVSizeEx() .....                           | 2788 |
| 7.3.4     | Examples .....                                   | 2789 |
| 7.3.4.1   | Basic example .....                              | 2789 |
| 7.3.4.2   | Real time example using the Window Manager ..... | 2790 |
| 7.3.4.3   | Dialog example using the Window Manager .....    | 2791 |
| 7.3.4.4   | Virtual screen API .....                         | 2792 |
| 7.3.4.4.1 | GUI_GetOrg() .....                               | 2793 |
| 7.3.4.4.2 | GUI_SetOrg() .....                               | 2794 |
| 8         | Tools .....                                      | 2795 |
| 8.1       | AppWizard .....                                  | 2796 |
| 8.1.1     | About the AppWizard .....                        | 2797 |
| 8.2       | emWinView .....                                  | 2798 |
| 8.2.1     | Installation .....                               | 2799 |
| 8.2.2     | Using the simulation and the viewer .....        | 2800 |
| 8.2.3     | Virtual pages .....                              | 2801 |
| 8.2.4     | Multibuffering .....                             | 2801 |
| 8.2.5     | Multiple displays .....                          | 2803 |
| 8.2.5.1   | Multiple layers .....                            | 2803 |
| 8.2.6     | Palette-based layers .....                       | 2805 |
| 8.2.7     | Tools .....                                      | 2806 |
| 8.2.7.1   | Selection Tool .....                             | 2806 |
| 8.2.7.2   | Hand Tool .....                                  | 2806 |
| 8.2.7.3   | Zooming .....                                    | 2807 |
| 8.2.7.4   | Grid .....                                       | 2807 |
| 8.2.8     | Options .....                                    | 2808 |
| 8.2.8.1   | Always on top .....                              | 2808 |
| 8.2.8.2   | Highlight palette colors .....                   | 2808 |
| 8.2.9     | Copy to clipboard .....                          | 2808 |
| 8.2.10    | Closing and opening layers .....                 | 2808 |
| 8.3       | Bitmap Converter .....                           | 2809 |
| 8.3.1     | What it does .....                               | 2809 |
| 8.3.2     | Loading a bitmap .....                           | 2810 |
| 8.3.2.1   | Supported input file formats .....               | 2810 |
| 8.3.2.2   | Loading from a file .....                        | 2810 |
| 8.3.2.3   | Using the clipboard .....                        | 2810 |
| 8.3.3     | Color conversion .....                           | 2811 |
| 8.3.4     | Dithering .....                                  | 2811 |
| 8.3.5     | Using a custom palette .....                     | 2812 |
| 8.3.5.1   | Saving a palette file .....                      | 2813 |
| 8.3.5.2   | Palette file format .....                        | 2813 |
| 8.3.5.3   | Palette files for fixed palette modes .....      | 2813 |
| 8.3.5.4   | Converting a bitmap .....                        | 2813 |
| 8.3.6     | Generating C files from bitmaps .....            | 2813 |
| 8.3.6.1   | Supported bitmap formats .....                   | 2814 |
| 8.3.6.2   | Palette information .....                        | 2814 |
| 8.3.6.3   | Transparency .....                               | 2815 |
| 8.3.6.4   | Alpha blending .....                             | 2815 |
| 8.3.6.5   | Selecting the best format .....                  | 2816 |
| 8.3.6.6   | Saving the file .....                            | 2817 |
| 8.3.7     | Generating C stream files .....                  | 2818 |
| 8.3.8     | Compressed bitmaps .....                         | 2820 |
| 8.3.9     | Creating animated sprites / cursors .....        | 2821 |
| 8.3.9.1   | Animated Sprite example .....                    | 2821 |
| 8.3.9.2   | Animated Cursor example .....                    | 2823 |
| 8.3.9.3   | Additional information .....                     | 2823 |
| 8.3.10    | Converting GIFs into Bitmap-EMFs .....           | 2824 |



|           |   |      |
|-----------|---|------|
| 8.3.11    | Memory footprint .....                                | 2826 |
| 8.3.12    | Command line usage .....                              | 2826 |
| 8.3.12.1  | Format for commands .....                             | 2826 |
| 8.3.12.2  | Command line options .....                            | 2826 |
| 8.3.13    | Options .....   | 2828 |
| 8.3.14    | Example of a converted bitmap .....                   | 2828 |
| 8.4       | Font Converter .....                                  | 2832 |
| 8.4.1     | Requirements .....                                    | 2832 |
| 8.4.2     | Creating an emWin font file from a Windows font ..... | 2833 |
| 8.4.3     | Font generation options dialog .....                  | 2835 |
| 8.4.3.1   | Type of font to generate .....                        | 2836 |
| 8.4.3.2   | Encoding .....  | 2836 |
| 8.4.3.3   | Antialiasing .....                                    | 2837 |
| 8.4.4     | Font Dialog .....                                     | 2837 |
| 8.4.4.1   | Font, Font Style, and Size .....                      | 2838 |
| 8.4.4.2   | Script .....  | 2838 |
| 8.4.4.3   | Unit of Size .....                                    | 2838 |
| 8.4.5     | User Interface .....                                  | 2839 |
| 8.4.5.1   | Selecting the current character .....                 | 2839 |
| 8.4.5.2   | Toggling character status .....                       | 2839 |
| 8.4.5.3   | Selecting pixels .....                                | 2839 |
| 8.4.5.4   | Modifying character bits .....                        | 2840 |
| 8.4.5.5   | Operations .....                                      | 2840 |
| 8.4.5.5.1 | Modifying the viewing mode .....                      | 2842 |
| 8.4.6     | Options .....   | 2842 |
| 8.4.7     | Saving the font .....                                 | 2844 |
| 8.4.7.1   | Creating a C file .....                               | 2844 |
| 8.4.7.2   | Creating a System Independent Font (SIF) .....        | 2844 |
| 8.4.7.3   | Creating an External Binary Font (XBF) .....          | 2844 |
| 8.4.8     | Loading and modifying a C font file .....             | 2844 |
| 8.4.9     | Loading Glyph (B)itmap (D)istribution (F)ormat .....  | 2844 |
| 8.4.10    | Merging fonts with existing C font files .....        | 2845 |
| 8.4.11    | Pattern files .....                                   | 2847 |
| 8.4.11.1  | Creating pattern files using Notepad .....            | 2847 |
| 8.4.11.2  | Creating pattern files using the Font Converter ..... | 2847 |
| 8.4.11.3  | Enabling characters using a pattern file .....        | 2847 |
| 8.4.12    | Command line options .....                            | 2847 |
| 8.4.12.1  | Table of commands .....                               | 2847 |
| 8.4.12.2  | Load an existing font file .....                      | 2849 |
| 8.4.12.3  | Execution examples .....                              | 2849 |
| 8.4.13    | Font Examples .....                                   | 2850 |
| 8.4.13.1  | Resulting C code, standard mode .....                 | 2850 |
| 8.4.13.2  | Resulting C code, 2 bpp anti-aliased mode .....       | 2851 |
| 8.4.13.3  | Resulting C code, 4 bpp anti-aliased mode .....       | 2852 |
| 8.4.13.4  | Resulting C code, extended mode .....                 | 2853 |
| 8.4.14    | Troubleshooting .....                                 | 2854 |
| 8.5       | emWinSPY .....  | 2855 |
| 8.5.1     | Introduction .....                                    | 2855 |
| 8.5.1.1   | Requirements .....                                    | 2855 |
| 8.5.1.2   | Availability .....                                    | 2856 |
| 8.5.2     | Starting the emWinSPY server.. ..                     | 2856 |
| 8.5.2.1   | ...in the simulation environment .....                | 2856 |
| 8.5.2.2   | ...on the target hardware .....                       | 2856 |
| 8.5.2.3   | GUI_SPY_X_StartServer .....                           | 2856 |
| 8.5.3     | The emWinSPY viewer .....                             | 2856 |
| 8.5.3.1   | The screen .....                                      | 2856 |
| 8.5.3.1.1 | Status area .....                                     | 2857 |
| 8.5.3.1.2 | History area .....                                    | 2857 |
| 8.5.3.1.3 | Windows area .....                                    | 2858 |
| 8.5.3.1.4 | Input area .....                                      | 2859 |

|         |  |      |
|---------|--|------|
| 8.5.3.2 | Connecting to target .....                             | 2859 |
| 8.5.3.3 | Configuration options .....                            | 2860 |
| 8.5.3.4 | Taking a screenshot from the target .....              | 2861 |
| 8.5.4   | emWinSPY API .....                                     | 2861 |
| 8.5.4.1 | GUI_SPY_Process() .....                                | 2862 |
| 8.5.4.2 | GUI_SPY_SetMemHandler() .....                          | 2863 |
| 8.5.4.3 | GUI_SPY_StartServer() .....                            | 2864 |
| 8.5.4.4 | GUI_SPY_StartServerEx() .....                          | 2865 |
| 8.5.4.5 | GUI_SPY_X_StartServer() .....                          | 2866 |
| 8.6     | GUI Builder .....                                      | 2867 |
| 8.6.1   | Introduction .....                                     | 2868 |
| 8.6.2   | Getting started .....                                  | 2869 |
| 8.6.3   | Creating a dialog .....                                | 2869 |
| 8.6.3.1 | Selecting a parent widget .....                        | 2869 |
| 8.6.3.2 | Resizing and positioning in the editor .....           | 2869 |
| 8.6.3.3 | Modifying the widget properties .....                  | 2870 |
| 8.6.3.4 | Adding additional functions to a widget .....          | 2870 |
| 8.6.3.5 | Deleting a widget property .....                       | 2871 |
| 8.6.3.6 | Deleting a widget .....                                | 2871 |
| 8.6.3.7 | Deleting a widget .....                                | 2871 |
| 8.6.4   | Saving the current dialog(s) .....                     | 2872 |
| 8.6.5   | Output of the GUIBuilder .....                         | 2872 |
| 8.6.6   | Modifying the C files .....                            | 2874 |
| 8.6.7   | How to use the C files .....                           | 2874 |
| 9       | Execution Model: Single Task / Multitask .....         | 2876 |
| 9.1     | Supported execution models .....                       | 2877 |
| 9.2     | Single task system (super loop) .....                  | 2878 |
| 9.2.1   | Description .....                                      | 2878 |
| 9.2.2   | Superloop example (without emWin) .....                | 2878 |
| 9.2.3   | Advantages .....                                       | 2878 |
| 9.2.4   | Disadvantages .....                                    | 2878 |
| 9.2.5   | Using emWin .....                                      | 2878 |
| 9.2.6   | Superloop example (with emWin) .....                   | 2878 |
| 9.3     | Multitask system: one task calling emWin .....         | 2880 |
| 9.3.1   | Description .....                                      | 2880 |
| 9.3.2   | Advantages .....                                       | 2880 |
| 9.3.3   | Using emWin .....                                      | 2880 |
| 9.4     | Multitask system: multiple tasks calling emWin .....   | 2881 |
| 9.4.1   | Description .....                                      | 2881 |
| 9.4.2   | Advantages .....                                       | 2881 |
| 9.4.3   | Using emWin .....                                      | 2881 |
| 9.4.4   | Recommendations .....                                  | 2881 |
| 9.4.5   | Example .....  | 2881 |
| 9.5     | Configuration functions for multitasking support ..... | 2883 |
| 9.5.1   | GUI_SetSignalEventFunc() .....                         | 2884 |
| 9.5.2   | GUI_SetWaitEventFunc() .....                           | 2885 |
| 9.5.3   | GUI_SetWaitEventTimedFunc() .....                      | 2886 |
| 9.5.4   | GUI_WaitEvent() .....                                  | 2887 |
| 9.6     | Configuration macros for multitasking support .....    | 2888 |
| 9.6.1   | GUI_MAXTASK .....                                      | 2888 |
| 9.6.2   | GUI_OS .....   | 2888 |
| 9.6.3   | GUI_X_SIGNAL_EVENT .....                               | 2888 |
| 9.6.4   | GUI_X_WAIT_EVENT .....                                 | 2889 |
| 9.6.5   | GUI_X_WAIT_EVENT_TIMED .....                           | 2889 |
| 9.7     | Kernel interface API .....                             | 2890 |
| 9.7.1   | GUI_X_GetTaskId() .....                                | 2891 |
| 9.7.2   | GUI_X_InitOS() .....                                   | 2892 |
| 9.7.3   | GUI_X_Lock() .....                                     | 2893 |

|          |  |      |
|----------|--|------|
| 9.7.4    | GUI_X_SignalEvent()                              | 2894 |
| 9.7.5    | GUI_X_Unlock()                                   | 2895 |
| 9.7.6    | GUI_X_WaitEvent()                                | 2896 |
| 9.7.7    | GUI_X_WaitEventTimed()                           | 2897 |
| 9.8      | Examples   | 2898 |
| 10       | MultiLayer / MultiDisplay support                | 2900 |
| 10.1     | Introduction                                     | 2901 |
| 10.1.1   | Selecting a layer for drawing operations         | 2901 |
| 10.1.2   | Selecting a layer for a window                   | 2901 |
| 10.1.2.1 | Moving a window from one layer to another        | 2902 |
| 10.2     | Using MultiLayer support                         | 2904 |
| 10.2.1   | Transparency                                     | 2904 |
| 10.2.2   | Alpha blending                                   | 2905 |
| 10.2.3   | Hardware cursors                                 | 2906 |
| 10.2.4   | MultiLayer example                               | 2906 |
| 10.2.5   | Configuring MultiLayer support                   | 2907 |
| 10.3     | Using MultiDisplay support                       | 2908 |
| 10.3.1   | Enabling MultiDisplay support                    | 2908 |
| 10.3.2   | Run-time screen rotation                         | 2908 |
| 10.3.3   | MultiDisplay example                             | 2908 |
| 10.3.4   | Configuring MultiDisplay support                 | 2909 |
| 10.4     | Using SoftLayers                                 | 2910 |
| 10.4.1   | Using SoftLayers within a simulation environment | 2910 |
| 10.4.2   | Memory requirements                              | 2911 |
| 10.4.3   | Configuring SoftLayers                           | 2911 |
| 10.5     | MultiLayer API                                   | 2913 |
| 10.5.1   | General MultiLayer functions                     | 2914 |
| 10.5.1.1 | GUI_AssignCursorLayer()                          | 2914 |
| 10.5.1.2 | GUI_GetLayerPosEx()                              | 2915 |
| 10.5.1.3 | GUI_SelectLayer()                                | 2916 |
| 10.5.1.4 | GUI_SetLayerAlphaEx()                            | 2917 |
| 10.5.1.5 | GUI_SetLayerPosEx()                              | 2918 |
| 10.5.1.6 | GUI_SetLayerSizeEx()                             | 2919 |
| 10.5.1.7 | GUI_SetLayerVisEx()                              | 2920 |
| 10.5.1.8 | LCD_GetNumLayers()                               | 2921 |
| 10.5.2   | SoftLayer specific functions                     | 2922 |
| 10.5.2.1 | GUI_SOFTLAYER_Enable()                           | 2922 |
| 10.5.2.2 | GUI_SOFTLAYER_Refresh()                          | 2923 |
| 10.5.2.3 | GUI_SOFTLAYER_SetCompositeColor()                | 2924 |
| 10.5.2.4 | GUI_SOFTLAYER_MULTIBUF_Enable()                  | 2925 |
| 10.5.3   | Data structures                                  | 2926 |
| 10.5.3.1 | GUI_SOFTLAYER_CONFIG                             | 2926 |
| 11       | Display drivers                                  | 2927 |
| 11.1     | Available display drivers                        | 2928 |
| 11.1.1   | Driver file naming convention                    | 2928 |
| 11.1.2   | Run-time configurable drivers                    | 2928 |
| 11.1.3   | Compile-time configurable drivers                | 2929 |
| 11.1.4   | Special purpose drivers                          | 2930 |
| 11.2     | CPU / Display controller interface               | 2931 |
| 11.2.1   | Direct interface                                 | 2931 |
| 11.2.2   | Indirect interface - Parallel bus                | 2931 |
| 11.2.2.1 | Example routines for connection to I/O pins      | 2932 |
| 11.2.3   | Indirect interface - 4 pin SPI                   | 2932 |
| 11.2.3.1 | Example routines for connection to I/O pins      | 2932 |
| 11.2.4   | Indirect interface - 3 pin SPI                   | 2932 |
| 11.2.4.1 | Example routines for connection to I/O pins      | 2933 |
| 11.2.5   | Indirect interface - I2C bus                     | 2933 |

|            |   |      |
|------------|---|------|
| 11.2.5.1   | Example routines for connection to I/O pins .....         | 2933 |
| 11.3       | Hardware interface configuration .....                    | 2934 |
| 11.3.1     | Direct interface .....                                    | 2934 |
| 11.3.2     | Indirect interface .....                                  | 2934 |
| 11.3.2.1   | Run-time configuration .....                              | 2934 |
| 11.3.2.1.1 | Elements of structure GUI_PORT_API .....                  | 2934 |
| 11.3.2.2   | Compile-time configuration .....                          | 2937 |
| 11.3.2.2.1 | LCD_READ_A0 .....   | 2938 |
| 11.3.2.2.2 | LCD_READ_A1 .....   | 2938 |
| 11.3.2.2.3 | LCD_WRITE_A0 .....  | 2938 |
| 11.3.2.2.4 | LCD_WRITE_A1 .....  | 2939 |
| 11.3.2.2.5 | LCD_WRITEM_A1 .....                                       | 2939 |
| 11.3.2.2.6 | LCD_WRITE .....   | 2939 |
| 11.3.2.2.7 | LCD_WRITEM .....  | 2939 |
| 11.4       | Non readable displays .....                               | 2941 |
| 11.5       | Display orientation .....                                 | 2942 |
| 11.5.1     | Driver based configuration of display orientation .....   | 2942 |
| 11.5.1.1   | Run-time configuration .....                              | 2942 |
| 11.5.1.2   | Compile-time configuration .....                          | 2942 |
| 11.5.2     | Runtime rotation .....                                    | 2943 |
| 11.5.2.1   | LCD_ROTATE_AddDriver() .....                              | 2944 |
| 11.5.2.2   | LCD_ROTATE_AddDriverEx() .....                            | 2945 |
| 11.5.2.3   | LCD_ROTATE_DecSel() .....                                 | 2946 |
| 11.5.2.4   | LCD_ROTATE_DecSelEx() .....                               | 2947 |
| 11.5.2.5   | LCD_ROTATE_IncSel() .....                                 | 2948 |
| 11.5.2.6   | LCD_ROTATE_IncSelEx() .....                               | 2949 |
| 11.5.2.7   | LCD_ROTATE_SetCallback() .....                            | 2950 |
| 11.5.2.8   | LCD_ROTATE_SetSel() .....                                 | 2951 |
| 11.5.2.9   | LCD_ROTATE_SetSelEx() .....                               | 2952 |
| 11.5.3     | Function based configuration of display orientation ..... | 2953 |
| 11.5.3.1   | GUI_SetOrientation() .....                                | 2954 |
| 11.5.3.2   | GUI_SetOrientationEx() .....                              | 2955 |
| 11.5.4     | Orientation flags .....                                   | 2956 |
| 11.6       | Display driver callback function .....                    | 2957 |
| 11.6.1     | Commands passed to the callback function .....            | 2957 |
| 11.6.1.1   | LCD_X_INITCONTROLLER .....                                | 2957 |
| 11.6.1.2   | LCD_X_ON .....  | 2957 |
| 11.6.1.3   | LCD_X_OFF .....   | 2957 |
| 11.6.1.4   | LCD_X_SETALPHA .....                                      | 2957 |
| 11.6.1.5   | LCD_X_SETLUTENTRY .....                                   | 2958 |
| 11.6.1.6   | LCD_X_SETORG .....  | 2958 |
| 11.6.1.7   | LCD_X_SETPOS .....  | 2958 |
| 11.6.1.8   | LCD_X_SETSIZE .....                                       | 2959 |
| 11.6.1.9   | LCD_X_SETVIS .....  | 2959 |
| 11.6.1.10  | LCD_X_SETVRAMADDR .....                                   | 2960 |
| 11.6.1.11  | LCD_X_SHOWBUFFER .....                                    | 2960 |
| 11.7       | Detailed display driver descriptions .....                | 2961 |
| 11.7.1     | GUIDRV_BitPlains .....                                    | 2961 |
| 11.7.1.1   | Supported hardware .....                                  | 2961 |
| 11.7.1.2   | Driver selection .....                                    | 2961 |
| 11.7.1.3   | Display data RAM organization .....                       | 2962 |
| 11.7.1.4   | RAM requirements .....                                    | 2962 |
| 11.7.1.5   | Hardware configuration .....                              | 2962 |
| 11.7.1.6   | Additional run-time configuration .....                   | 2962 |
| 11.7.1.7   | GUIDRV_BitPlains_Config() .....                           | 2964 |
| 11.7.2     | GUIDRV_DCache .....                                       | 2965 |
| 11.7.2.1   | Supported hardware .....                                  | 2965 |
| 11.7.2.2   | Driver selection .....                                    | 2965 |
| 11.7.2.3   | RAM requirements .....                                    | 2965 |
| 11.7.2.4   | Run-time configuration .....                              | 2965 |

|             |   |      |
|-------------|---|------|
| 11.7.2.5    | Configuration API .....                                 | 2966 |
| 11.7.2.5.1  | GUIDRV_DCache_AddDriver() .....                         | 2967 |
| 11.7.2.5.2  | GUIDRV_DCache_SetMode1bpp() .....                       | 2968 |
| 11.7.3      | GUIDRV_Dist .....                                       | 2969 |
| 11.7.3.1    | Supported hardware .....                                | 2969 |
| 11.7.3.2    | Driver selection .....                                  | 2969 |
| 11.7.3.3    | RAM requirements .....                                  | 2969 |
| 11.7.3.4    | Run-time configuration .....                            | 2969 |
| 11.7.3.5    | GUIDRV_Dist_AddDriver() .....                           | 2970 |
| 11.7.4      | GUIDRV_FlexColor .....                                  | 2971 |
| 11.7.4.1    | Supported hardware .....                                | 2971 |
| 11.7.4.2    | Driver selection .....                                  | 2971 |
| 11.7.4.3    | Display data RAM organization .....                     | 2971 |
| 11.7.4.4    | RAM requirements .....                                  | 2972 |
| 11.7.4.5    | Run-time configuration API .....                        | 2972 |
| 11.7.4.6    | Commands supported by LCD_SetDevFunc() .....            | 2972 |
| 11.7.4.7    | Configuration API .....                                 | 2973 |
| 11.7.4.7.1  | GUIDRV_FlexColor_SetFunc() .....                        | 2975 |
| 11.7.4.7.2  | GUIDRV_FlexColor_Config() .....                         | 2979 |
| 11.7.4.7.3  | GUIDRV_FlexColor_SetOrientation() .....                 | 2980 |
| 11.7.4.7.4  | GUIDRV_FlexColor_SetInterface66712_B9() .....           | 2981 |
| 11.7.4.7.5  | GUIDRV_FlexColor_SetInterface66715_B9() .....           | 2981 |
| 11.7.4.7.6  | GUIDRV_FlexColor_SetInterface66712_B18() .....          | 2982 |
| 11.7.4.7.7  | GUIDRV_FlexColor_SetInterface66715_B18() .....          | 2982 |
| 11.7.4.7.8  | GUIDRV_FlexColor_SetReadFunc66709_B16() .....           | 2983 |
| 11.7.4.7.9  | GUIDRV_FlexColor_SetReadFunc66712_B9() .....            | 2985 |
| 11.7.4.7.10 | GUIDRV_FlexColor_SetReadFunc66715_B9() .....            | 2985 |
| 11.7.4.7.11 | GUIDRV_FlexColor_SetReadFunc66712_B16() .....           | 2986 |
| 11.7.4.7.12 | GUIDRV_FlexColor_SetReadFunc66715_B16() .....           | 2986 |
| 11.7.4.7.13 | GUIDRV_FlexColor_SetReadFunc66720_B16() .....           | 2988 |
| 11.7.4.7.14 | GUIDRV_FlexColor_SetReadFunc66772_B8() .....            | 2989 |
| 11.7.4.7.15 | GUIDRV_FlexColor_SetReadFunc66772_B16() .....           | 2990 |
| 11.7.5      | GUIDRV_IST3088 .....                                    | 2991 |
| 11.7.5.1    | Supported hardware .....                                | 2991 |
| 11.7.5.2    | Driver selection .....                                  | 2991 |
| 11.7.5.3    | Display data RAM organization .....                     | 2991 |
| 11.7.5.4    | RAM requirements .....                                  | 2991 |
| 11.7.5.5    | Run-time configuration .....                            | 2991 |
| 11.7.5.5.1  | GUIDRV_IST3088_SetBus16() .....                         | 2993 |
| 11.7.5.6    | Required GUI_PORT_API routines .....                    | 2993 |
| 11.7.5.7    | Special requirements .....                              | 2993 |
| 11.7.6      | GUIDRV_Lin .....  | 2994 |
| 11.7.6.1    | Supported hardware .....                                | 2994 |
| 11.7.6.2    | Color depth and display orientation .....               | 2994 |
| 11.7.6.3    | Driver selection .....                                  | 2995 |
| 11.7.6.4    | Display data RAM organization .....                     | 2996 |
| 11.7.6.5    | RAM requirements .....                                  | 2997 |
| 11.7.6.6    | Compile-time configuration .....                        | 2997 |
| 11.7.6.7    | Run-time configuration .....                            | 2997 |
| 11.7.6.8    | Commands supported by LCD_SetDevFunc() .....            | 2997 |
| 11.7.6.9    | Configuration example .....                             | 2997 |
| 11.7.6.10   | Using the Lin driver in systems with cache memory ..... | 2998 |
| 11.7.7      | GUIDRV_S1D13L04 .....                                   | 2999 |
| 11.7.8      | GUIDRV_S1D13513 .....                                   | 2999 |
| 11.7.8.1    | Supported hardware .....                                | 2999 |
| 11.7.8.2    | Driver selection .....                                  | 2999 |
| 11.7.8.3    | Display data RAM organization .....                     | 3000 |
| 11.7.8.4    | RAM requirements .....                                  | 3000 |
| 11.7.8.5    | Basic function .....                                    | 3000 |
| 11.7.8.6    | Run-time configuration .....                            | 3000 |

|             |                                    |      |
|-------------|------------------------------------|------|
| 11.7.8.6.1  | GUIDRV_S1D13L04_Config()           | 3001 |
| 11.7.8.6.2  | GUIDRV_S1D13513_Config()           | 3001 |
| 11.7.8.6.3  | GUIDRV_S1D13L04_SetBus16()         | 3002 |
| 11.7.8.6.4  | GUIDRV_S1D13513_SetBus16()         | 3002 |
| 11.7.9      | GUIDRV_S1D13L02                    | 3003 |
| 11.7.10     | GUIDRV_S1D13748                    | 3003 |
| 11.7.10.1   | Supported hardware                 | 3003 |
| 11.7.10.2   | Basic function                     | 3003 |
| 11.7.10.3   | Driver selection                   | 3003 |
| 11.7.10.4   | Display data RAM organization      | 3004 |
| 11.7.10.5   | RAM requirements                   | 3004 |
| 11.7.10.6   | Run-time configuration             | 3004 |
| 11.7.10.6.1 | GUIDRV_S1D13L02_Config()           | 3005 |
| 11.7.10.6.2 | GUIDRV_S1D13748_Config()           | 3005 |
| 11.7.10.6.3 | GUIDRV_S1D13L02_SetBus16()         | 3006 |
| 11.7.10.6.4 | GUIDRV_S1D13748_SetBus16()         | 3006 |
| 11.7.10.7   | Required GUI_PORT_API routines     | 3006 |
| 11.7.10.8   | Special requirements               | 3006 |
| 11.7.11     | GUIDRV_S1D13L01                    | 3007 |
| 11.7.12     | GUIDRV_S1D13781                    | 3007 |
| 11.7.12.1   | Supported hardware                 | 3007 |
| 11.7.12.2   | Display orientation                | 3007 |
| 11.7.12.3   | Driver selection                   | 3007 |
| 11.7.12.4   | Display data RAM organization      | 3008 |
| 11.7.12.5   | RAM requirements                   | 3008 |
| 11.7.12.6   | Run-time configuration             | 3008 |
| 11.7.12.6.1 | GUIDRV_S1D13L01_Config()           | 3010 |
| 11.7.12.6.2 | GUIDRV_S1D13781_Config()           | 3010 |
| 11.7.12.6.3 | GUIDRV_S1D13L01_SetBusSPI()        | 3011 |
| 11.7.12.6.4 | GUIDRV_S1D13781_SetBusSPI()        | 3011 |
| 11.7.12.6.5 | GUIDRV_S1D13L01_SetOrientation()   | 3012 |
| 11.7.12.6.6 | GUIDRV_S1D13781_SetOrientation()   | 3012 |
| 11.7.12.7   | Required GUI_PORT_API routines     | 3012 |
| 11.7.12.8   | Optional functions                 | 3012 |
| 11.7.12.9   | Additional information             | 3013 |
| 11.7.13     | GUIDRV_S1D15G00                    | 3014 |
| 11.7.13.1   | Supported hardware                 | 3014 |
| 11.7.13.2   | Driver selection                   | 3014 |
| 11.7.13.3   | Display data RAM organization      | 3014 |
| 11.7.13.4   | RAM requirements                   | 3014 |
| 11.7.13.5   | Run-time configuration             | 3015 |
| 11.7.13.5.1 | GUIDRV_S1D15G00_Config()           | 3016 |
| 11.7.13.5.2 | GUIDRV_S1D15G00_SetBus8()          | 3017 |
| 11.7.13.6   | Required GUI_PORT_API routines     | 3017 |
| 11.7.13.7   | Configuration example              | 3017 |
| 11.7.14     | GUIDRV_SH_MEM                      | 3018 |
| 11.7.14.1   | Supported hardware                 | 3018 |
| 11.7.14.2   | Display orientation                | 3018 |
| 11.7.14.3   | Driver selection                   | 3019 |
| 11.7.14.4   | Display data RAM organization 1bpp | 3019 |
| 11.7.14.5   | Display data RAM organization 3bpp | 3019 |
| 11.7.14.6   | RAM requirements                   | 3019 |
| 11.7.14.7   | Run-time configuration             | 3019 |
| 11.7.14.7.1 | GUIDRV_SH_MEM_Config()             | 3021 |
| 11.7.14.7.2 | GUIDRV_SH_MEM_3_Config()           | 3021 |
| 11.7.14.7.3 | GUIDRV_SH_MEM_SetBus8()            | 3022 |
| 11.7.14.7.4 | GUIDRV_SH_MEM_3_SetBus8()          | 3022 |
| 11.7.14.8   | Required GUI_PORT_API routines     | 3023 |
| 11.7.14.9   | Configuration Example              | 3023 |
| 11.7.15     | GUIDRV_SLin                        | 3024 |

|              |   |      |
|--------------|---|------|
| 11.7.15.1    | Supported hardware .....                  | 3024 |
| 11.7.15.2    | Color depth and display orientation ..... | 3024 |
| 11.7.15.3    | Driver selection .....                    | 3025 |
| 11.7.15.4    | Display data RAM organization .....       | 3025 |
| 11.7.15.5    | RAM requirements .....                    | 3025 |
| 11.7.15.6    | Run-time configuration .....              | 3025 |
| 11.7.15.6.1  | GUIDRV_SLin_Config() .....                | 3027 |
| 11.7.15.6.2  | GUIDRV_SLin_SetBus8() .....               | 3028 |
| 11.7.15.6.3  | GUIDRV_SLin_SetS1D13700() .....           | 3029 |
| 11.7.15.6.4  | GUIDRV_SLin_SetSSD1325() .....            | 3030 |
| 11.7.15.6.5  | GUIDRV_SLin_SetSSD1848() .....            | 3031 |
| 11.7.15.6.6  | GUIDRV_SLin_SetT6963() .....              | 3032 |
| 11.7.15.6.7  | GUIDRV_SLin_SetUC1617() .....             | 3033 |
| 11.7.15.7    | Configuration example .....               | 3034 |
| 11.7.16      | GUIDRV_SLinEPD .....                      | 3035 |
| 11.7.16.1    | Description .....                         | 3035 |
| 11.7.16.2    | Supported hardware .....                  | 3035 |
| 11.7.16.3    | Color depth and display orientation ..... | 3036 |
| 11.7.16.4    | Driver selection .....                    | 3036 |
| 11.7.16.5    | Display data RAM organization .....       | 3036 |
| 11.7.16.6    | RAM requirements .....                    | 3036 |
| 11.7.16.7    | Run-time configuration .....              | 3037 |
| 11.7.16.7.1  | GUIDRV_SLinEPD_Config() .....             | 3038 |
| 11.7.16.7.2  | GUIDRV_SLinEPD_EnableFastMode() .....     | 3039 |
| 11.7.16.7.3  | GUIDRV_SLinEPD_EnablePartialMode() .....  | 3040 |
| 11.7.16.7.4  | GUIDRV_SLinEPD_SetBus8() .....            | 3041 |
| 11.7.16.7.5  | GUIDRV_SLinEPD_SetSSD1673() .....         | 3042 |
| 11.7.16.7.6  | GUIDRV_SLinEPD_SetUC8451() .....          | 3043 |
| 11.7.16.8    | Configuration example .....               | 3044 |
| 11.7.17      | GUIDRV_SPage .....                        | 3045 |
| 11.7.17.1    | Supported hardware .....                  | 3045 |
| 11.7.17.2    | Color depth and display orientation ..... | 3045 |
| 11.7.17.3    | Driver selection .....                    | 3046 |
| 11.7.17.4    | Display data RAM organization .....       | 3047 |
| 11.7.17.5    | RAM requirements .....                    | 3047 |
| 11.7.17.6    | Run-time configuration .....              | 3047 |
| 11.7.17.6.1  | GUIDRV_SPage_Config() .....               | 3049 |
| 11.7.17.6.2  | GUIDRV_SPage_SetBus8() .....              | 3050 |
| 11.7.17.6.3  | GUIDRV_SPage_Set1502() .....              | 3051 |
| 11.7.17.6.4  | GUIDRV_SPage_Set1510() .....              | 3052 |
| 11.7.17.6.5  | GUIDRV_SPage_Set1512() .....              | 3053 |
| 11.7.17.6.6  | GUIDRV_SPage_SetST75256() .....           | 3054 |
| 11.7.17.6.7  | GUIDRV_SPage_SetST75320() .....           | 3055 |
| 11.7.17.6.8  | GUIDRV_SPage_SetST7591() .....            | 3056 |
| 11.7.17.6.9  | GUIDRV_SPage_SetUC1610() .....            | 3057 |
| 11.7.17.6.10 | GUIDRV_SPage_SetUC1611() .....            | 3058 |
| 11.7.17.6.11 | GUIDRV_SPage_SetUC1628() .....            | 3059 |
| 11.7.17.6.12 | GUIDRV_SPage_SetUC1638() .....            | 3060 |
| 11.7.17.7    | Configuration Example .....               | 3061 |
| 11.7.18      | GUIDRV_SSD1322 .....                      | 3062 |
| 11.7.18.1    | Supported hardware .....                  | 3062 |
| 11.7.18.2    | Driver selection .....                    | 3062 |
| 11.7.18.3    | Display data RAM organization .....       | 3062 |
| 11.7.18.4    | RAM requirements .....                    | 3062 |
| 11.7.18.5    | Run-time configuration .....              | 3062 |
| 11.7.18.5.1  | GUIDRV_SSD1322_Config() .....             | 3063 |
| 11.7.18.5.2  | GUIDRV_SSD1322_SetBus8() .....            | 3064 |
| 11.7.18.6    | Required GUI_PORT_API routines .....      | 3065 |
| 11.7.18.7    | Configuration example .....               | 3065 |
| 11.7.19      | GUIDRV_SSD1926 .....                      | 3066 |

|             |  |      |
|-------------|--|------|
| 11.7.19.1   | Supported hardware .....                                       | 3066 |
| 11.7.19.2   | Color depth and display orientation .....                      | 3066 |
| 11.7.19.3   | Driver selection .....   | 3066 |
| 11.7.19.4   | Display data RAM organization .....                            | 3066 |
| 11.7.19.5   | RAM requirements .....   | 3067 |
| 11.7.19.6   | Run-time configuration .....                                   | 3067 |
| 11.7.19.6.1 | GUIDRV_SSD1926_Config() .....                                  | 3068 |
| 11.7.19.6.2 | GUIDRV_SSD1926_SetBus16() .....                                | 3069 |
| 11.7.19.7   | Required GUI_PORT_API routines .....                           | 3069 |
| 11.7.19.8   | Configuration Example .....                                    | 3069 |
| 11.7.20     | GUIDRV_UC1698G .....   | 3071 |
| 11.7.20.1   | Supported Hardware .....                                       | 3071 |
| 11.7.20.2   | Color depth and display orientation .....                      | 3071 |
| 11.7.20.3   | Driver selection .....   | 3071 |
| 11.7.20.4   | Display data RAM organization .....                            | 3072 |
| 11.7.20.5   | RAM requirements .....   | 3072 |
| 11.7.20.6   | Run-time configuration .....                                   | 3072 |
| 11.7.20.6.1 | GUIDRV_UC1698G_Config() .....                                  | 3073 |
| 11.7.20.6.2 | GUIDRV_UC1698G_SetBus8() .....                                 | 3074 |
| 11.7.20.6.3 | GUIDRV_UC1698G_SetBus16() .....                                | 3075 |
| 11.7.20.7   | Required GUI_PORT_API routines .....                           | 3076 |
| 11.7.21     | GUIDRV_CompactColor_16 .....                                   | 3077 |
| 11.7.21.1   | Supported Hardware .....                                       | 3077 |
| 11.7.21.2   | Driver selection and configuration .....                       | 3077 |
| 11.7.21.3   | Display data RAM organization .....                            | 3078 |
| 11.7.21.4   | RAM requirements .....   | 3078 |
| 11.7.21.5   | Compile-time configuration .....                               | 3078 |
| 11.7.21.6   | Additional configuration switches .....                        | 3080 |
| 11.7.21.7   | Configuration example .....                                    | 3080 |
| 11.7.22     | GUIDRV_Fujitsu_16 .....  | 3082 |
| 11.7.22.1   | Supported hardware .....                                       | 3082 |
| 11.7.22.2   | Driver selection and configuration .....                       | 3082 |
| 11.7.22.3   | Available configuration macros (compile time configuration) .. | 3082 |
| 11.7.22.4   | Display data RAM organization .....                            | 3082 |
| 11.7.22.5   | RAM requirements .....   | 3082 |
| 11.7.22.6   | Hardware configuration .....                                   | 3083 |
| 11.7.22.7   | Additional configuration switches .....                        | 3083 |
| 11.7.23     | GUIDRV_Page1bpp .....  | 3084 |
| 11.7.23.1   | Supported hardware .....                                       | 3084 |
| 11.7.23.2   | Driver selection and configuration .....                       | 3084 |
| 11.7.23.3   | Compile-time configuration .....                               | 3084 |
| 11.7.23.4   | RAM requirements .....   | 3085 |
| 11.7.23.5   | Additional driver functions .....                              | 3085 |
| 11.7.23.6   | Hardware configuration .....                                   | 3086 |
| 11.7.23.7   | Additional configuration switches .....                        | 3086 |
| 11.7.24     | GUIDRV_07X1 .....  | 3087 |
| 11.7.24.1   | Supported hardware .....                                       | 3087 |
| 11.7.24.2   | Driver selection and configuration .....                       | 3087 |
| 11.7.24.3   | Display data RAM organization .....                            | 3088 |
| 11.7.24.4   | RAM requirements .....   | 3088 |
| 11.7.24.5   | Additional driver functions .....                              | 3088 |
| 11.7.24.6   | Hardware configuration .....                                   | 3088 |
| 11.7.24.7   | Additional configuration switches .....                        | 3089 |
| 11.7.25     | GUIDRV_6331 .....  | 3090 |
| 11.7.25.1   | Supported hardware .....                                       | 3090 |
| 11.7.25.2   | Driver selection and configuration .....                       | 3090 |
| 11.7.25.3   | Display data RAM organization .....                            | 3091 |
| 11.7.25.4   | RAM requirements .....   | 3091 |
| 11.7.25.5   | Hardware configuration .....                                   | 3091 |
| 11.7.25.6   | Additional configuration switches .....                        | 3091 |



|             |   |      |
|-------------|---|------|
| 11.7.25.7   | Special requirements .....                        | 3092 |
| 11.7.26     | GUIDRV_7528 .....                                 | 3093 |
| 11.7.26.1   | Supported hardware .....                          | 3093 |
| 11.7.26.2   | Driver selection and configuration .....          | 3093 |
| 11.7.26.3   | Display data RAM organization .....               | 3094 |
| 11.7.26.4   | RAM requirements .....                            | 3094 |
| 11.7.26.5   | Hardware configuration .....                      | 3094 |
| 11.7.26.6   | Additional configuration switches .....           | 3095 |
| 11.7.27     | GUIDRV_7529 .....                                 | 3096 |
| 11.7.27.1   | Supported hardware .....                          | 3096 |
| 11.7.27.2   | Driver selection and configuration .....          | 3096 |
| 11.7.27.3   | Display data RAM organization .....               | 3097 |
| 11.7.27.4   | RAM requirements .....                            | 3097 |
| 11.7.27.5   | Hardware configuration .....                      | 3098 |
| 11.7.27.6   | Additional configuration switches .....           | 3098 |
| 11.7.28     | GUIDRV_Template - Template for a new driver ..... | 3099 |
| 11.8        | LCD layer and display driver API .....            | 3100 |
| 11.8.1      | Display driver API .....                          | 3100 |
| 11.8.1.1    | "Get" group .....                                 | 3102 |
| 11.8.1.1.1  | LCD_GetBitsPerPixel() .....                       | 3102 |
| 11.8.1.1.2  | LCD_GetBitsPerPixelEx() .....                     | 3103 |
| 11.8.1.1.3  | LCD_GetNumColors() .....                          | 3104 |
| 11.8.1.1.4  | LCD_GetNumColorsEx() .....                        | 3105 |
| 11.8.1.1.5  | LCD_GetPosEx() .....                              | 3106 |
| 11.8.1.1.6  | LCD_GetVRAMAddr() .....                           | 3107 |
| 11.8.1.1.7  | LCD_GetVRAMAddrEx() .....                         | 3108 |
| 11.8.1.1.8  | LCD_GetVXSize() .....                             | 3109 |
| 11.8.1.1.9  | LCD_GetVYSize() .....                             | 3109 |
| 11.8.1.1.10 | LCD_GetVXSizeEx() .....                           | 3110 |
| 11.8.1.1.11 | LCD_GetVYSizeEx() .....                           | 3110 |
| 11.8.1.1.12 | LCD_GetXMag() .....                               | 3111 |
| 11.8.1.1.13 | LCD_GetYMag() .....                               | 3111 |
| 11.8.1.1.14 | LCD_GetXMagEx() .....                             | 3112 |
| 11.8.1.1.15 | LCD_GetYMagEx() .....                             | 3112 |
| 11.8.1.1.16 | LCD_GetXSize() .....                              | 3113 |
| 11.8.1.1.17 | LCD_GetYSize() .....                              | 3113 |
| 11.8.1.1.18 | LCD_GetXSizeEx() .....                            | 3114 |
| 11.8.1.1.19 | LCD_GetYSizeEx() .....                            | 3114 |
| 11.8.1.2    | "Set" group .....                                 | 3115 |
| 11.8.1.2.1  | LCD_SetAlphaEx() .....                            | 3115 |
| 11.8.1.2.2  | LCD_SetAlphaModeEx() .....                        | 3116 |
| 11.8.1.2.3  | LCD_SetChromaEx() .....                           | 3117 |
| 11.8.1.2.4  | LCD_SetChromaModeEx() .....                       | 3118 |
| 11.8.1.2.5  | LCD_SetPosEx() .....                              | 3119 |
| 11.8.1.2.6  | LCD_SetVisEx() .....                              | 3120 |
| 11.8.1.3    | Configuration group .....                         | 3121 |
| 11.8.1.3.1  | LCD_SetBufferPtr() .....                          | 3121 |
| 11.8.1.3.2  | LCD_SetBufferPtrEx() .....                        | 3122 |
| 11.8.1.3.3  | LCD_Off() .....                                   | 3123 |
| 11.8.1.3.4  | LCD_OffEx() .....                                 | 3124 |
| 11.8.1.3.5  | LCD_On() .....                                    | 3125 |
| 11.8.1.3.6  | LCD_OnEx() .....                                  | 3126 |
| 11.8.1.3.7  | LCD_Refresh() .....                               | 3127 |
| 11.8.1.3.8  | LCD_RefreshEx() .....                             | 3128 |
| 11.8.1.3.9  | LCD_SetDevFunc() .....                            | 3129 |
| 11.8.1.3.10 | LCD_SetMaxNumColors() .....                       | 3133 |
| 11.8.1.3.11 | LCD_SetSizeEx() .....                             | 3134 |
| 11.8.1.3.12 | LCD_SetVRAMAddrEx() .....                         | 3135 |
| 11.8.1.3.13 | LCD_SetVSizeEx() .....                            | 3136 |
| 11.8.1.4    | Cache group .....                                 | 3137 |

|            |  |      |
|------------|--|------|
| 11.8.1.4.1 | LCD_ControlCache()                                   | 3137 |
| 12         | Touch drivers  | 3138 |
| 12.1       | GUIMTDRV_TangoC32                                    | 3139 |
| 12.1.1     | Supported hardware                                   | 3139 |
| 12.1.2     | Driver initialization                                | 3139 |
| 12.1.3     | GUIMTDRV_TangoC32 API                                | 3139 |
| 12.1.3.1   | GUIMTDRV_TangoC32_Init()                             | 3140 |
| 12.2       | GUITDRV_ADS7846                                      | 3142 |
| 12.2.1     | Supported hardware                                   | 3142 |
| 12.2.2     | Driver initialization                                | 3142 |
| 12.2.3     | GUITDRV_ADS7846 API                                  | 3142 |
| 12.2.3.1   | GUITDRV_ADS7846_Config()                             | 3143 |
| 12.2.3.2   | GUITDRV_ADS7846_Exec()                               | 3145 |
| 12.2.3.3   | GUITDRV_ADS7846_GetLastVal()                         | 3146 |
| 13         | Performance and Resource Usage                       | 3147 |
| 13.1       | Performance  | 3148 |
| 13.1.1     | Driver benchmark                                     | 3148 |
| 13.1.2     | Image drawing performance                            | 3149 |
| 13.2       | Memory requirements                                  | 3151 |
| 13.2.1     | Memory requirements of the GUI components            | 3151 |
| 13.2.2     | Stack requirements                                   | 3152 |
| 13.3       | Memory requirements of example applications          | 3153 |
| 13.4       | Optimizing footprint                                 | 3154 |
| 13.4.1     | Optimizing RAM requirement                           | 3154 |
| 13.4.2     | Optimizing ROM requirement                           | 3154 |
| 13.4.3     | Features with appreciable additional RAM requirement | 3155 |
| 14         | Support  | 3156 |
| 14.1       | Problems with tool chain (compiler, linker)          | 3157 |
| 14.1.1     | Compiler crash                                       | 3157 |
| 14.1.2     | Compiler warnings                                    | 3157 |
| 14.1.3     | Compiler errors                                      | 3157 |
| 14.1.4     | Linker problems                                      | 3158 |
| 14.2       | Problems with hardware/driver                        | 3159 |
| 14.3       | Problems with API functions                          | 3160 |
| 14.4       | Problems with the performance                        | 3161 |
| 14.5       | Contacting support                                   | 3162 |
| 14.6       | FAQ  | 3163 |
| 15         | Indexes  | 3164 |
| 15.1       | Function index                                       | 3165 |
| 15.2       | Type index   | 3194 |

# Chapter 1

## Introduction to emWin

---

This introduction gives some information about this document. It also gives an overview of what features emWin consists of and what it requires.

## 1.1 Purpose of this document

This guide describes how to install, configure and use the emWin graphical user interface for embedded applications. It also explains the internal structure of the software and all the functions which are offered by emWin and intended for direct use (API, Application Programming Interface). Before actually using emWin, you should read or at least glance through this manual in order to become familiar with the software. The following steps are recommended:

- Copy the emWin files to your computer.
- Go through the chapter *Getting Started* on page 84
- Use the simulator in order to become more familiar with what the software can do (refer to the chapter *Simulation* on page 166).
- Expand your program using the rest of the manual for reference.

## 1.2 Requirements

A target system is not required in order to develop software with emWin; most of the software can be developed using the simulator. However, the final purpose is usually to be able to run the software on a target system.

### 1.2.1 Target system (hardware)

Your target system must:

- Have a CPU (16/32 bits)
- Have a CPU with 64 bits (LP64 and LLP64 data model)
- Have a minimum of RAM and ROM
- Have a full graphic display (any type and any resolution)

The RAM needs to be 8-, 16- and 32-bit accessible. Memory requirements vary depending on which parts of the software are used and how efficient your target compiler is. It is therefore not possible to specify precise values, but the following applies to typical systems.

#### Small systems (no Window Manager)

- RAM: 100 Bytes
- Stack: 600 Bytes
- ROM: 10-25 KBytes (depending on the functionality used)

#### Big systems (including Window Manager and widgets)

- RAM: 2-20 KBytes \*
- Stack: 1200-1800 bytes \*
- ROM: 30-120 KBytes \*

\* Depending on the functionality used. The numbers above are only a rough estimation and could not reflect the exact requirements of an application. RAM requirement can be increased significantly when using large memory devices or when drawing PNG images. ROM requirements increase according to the number of fonts and/or images used in the application. All values are rough estimates and cannot be guaranteed. More details can be found in the chapter *Performance and Resource Usage* on page 3147.

### 1.2.2 Development environment (compiler)

The CPU used is of no importance; only an ANSI-compliant C compiler complying with at least one of the following international standard is required:

- ISO/IEC/ANSI 9899:1990 (C90) with support for C++ style comments (//)
- ISO/IEC 9899:1999 (C99)
- ISO/IEC 14882:1998 (C++)

If your compiler has some limitations, let us know and we will inform you if these will be a problem when compiling the software. Any compiler for 16/32-bit CPUs or DSPs that we know of can be used. A C++ compiler is not required, but can be used. The application program can therefore also be programmed in C++ if desired.

#### Limitation

The code of emWin requires a 'char' type of 8 bits. If a 'char' is 16 bits the code of emWin does not work right.

## 1.3 Features

emWin is designed to provide an efficient, processor- and display controller-independent graphical user interface for any application that operates with a graphical display. It is compatible with single-task and multitask environments, with a proprietary operating system or with any commercial RTOS. emWin is shipped as C source code. It may be adapted to any size physical and virtual display with any display controller and CPU. Its features include the following:

### General

- Any (monochrome, grayscale or color) display with any controller supported (if the right driver is available).
- Any interface supported using configuration macros.
- May work without display controller on smaller displays.
- Display-size configurable.
- Characters and bitmaps may be written at any point on the display, not just on even-numbered byte addresses.
- Routines are optimized for both size and speed.
- Compile time switches allow for different optimizations.
- For slower display controllers, display can be cached in memory, reducing access to a minimum and resulting in very high speed.
- Clear structure.
- Virtual display support; the virtual display can be larger than the actual display.

### Graphic library

- Bitmaps of different color depths supported.
- Bitmap Converter available.
- Absolutely no floating-point usage.
- Fast line/point drawing (without floating-point usage).
- Very fast drawing of circles/polygons.
- Different drawing modes.

### Fonts

- A variety of different fonts are shipped with the basic software: 4×6, 6×8, 6×9, 8×8, 8×9, 8×16, 8×17, 8×18, 24×32, and proportional fonts with pixel-heights of 8, 10, 13, 16. For more information, see chapter *Fonts* on page 525.
- New fonts can be defined and simply linked in.
- Only the fonts used by the application are actually linked to the resulting executable, resulting in minimum ROM usage.
- Using the Font Converter, any font available on the host system (that is, Microsoft Windows) can be converted for use in emWin.
- Scalable iType and TTF fonts are supported.

### String/value output routines

- Routines to show values in decimal, binary, hexadecimal, any font.
- Routines to edit values in decimal, binary, hexadecimal, any font.

### Window Manager (WM)

- Complete window management including clipping. Overwriting of areas outside a window's client area is impossible.
- Windows can be moved and resized.
- Callback routines supported (usage optional).
- WM uses minimum RAM (approx. 50 bytes per window).

### Optional widgets for PC look and feel

- Widgets (window objects, also known as controls) are available. They generally operate automatically and are simple to use.

**Touch-screen & mouse support**

- For window objects such as the button widget, emWin offers touch-screen and mouse support.

**PC tools**

- Simulation library for WIN32-Environments. The source code may be purchased additionally.
- emWinView.
- Bitmap Converter.
- Font Converter.
- GUIBuilder.

# 1.4 Complete emWin system

The diagram below shows the individual components of a complete emWin system.

### Note

The touch controller components are marked as **optional** since they are not necessary for running emWin.

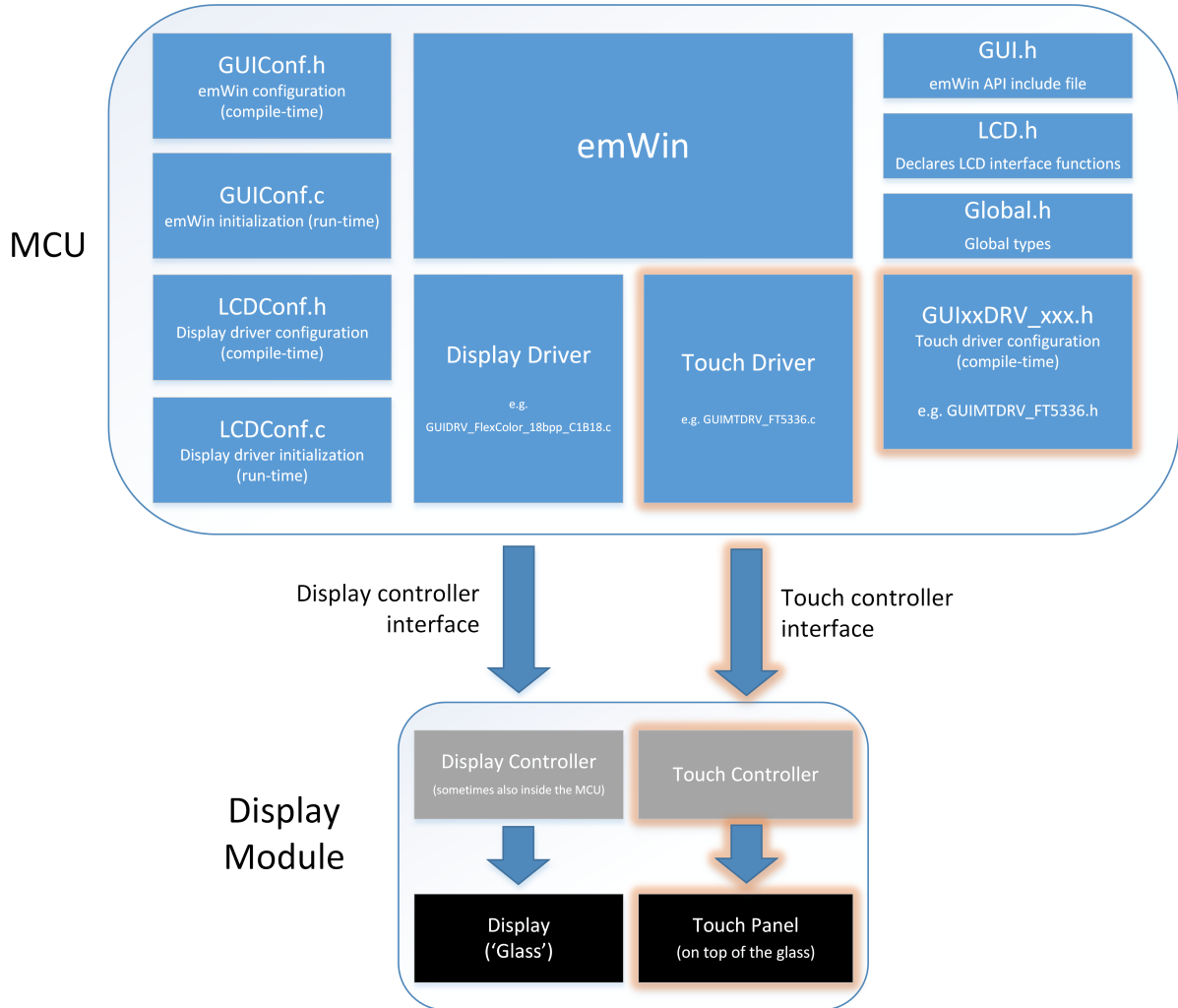





# 1.5 Examples and demos

To give you a better idea of what emWin can do, we have different demos available as “ready-to-use” simulation executables that you can find [here](#).

The source of the sample applications is located in the folder `Sample`. The folder `Sample\Application\GUIDemo` contains an application program showing many features of emWin. All examples are also available at [www.segger.com](http://www.segger.com). Example code in this documentation is provided as code snippet, which might require further modifications.

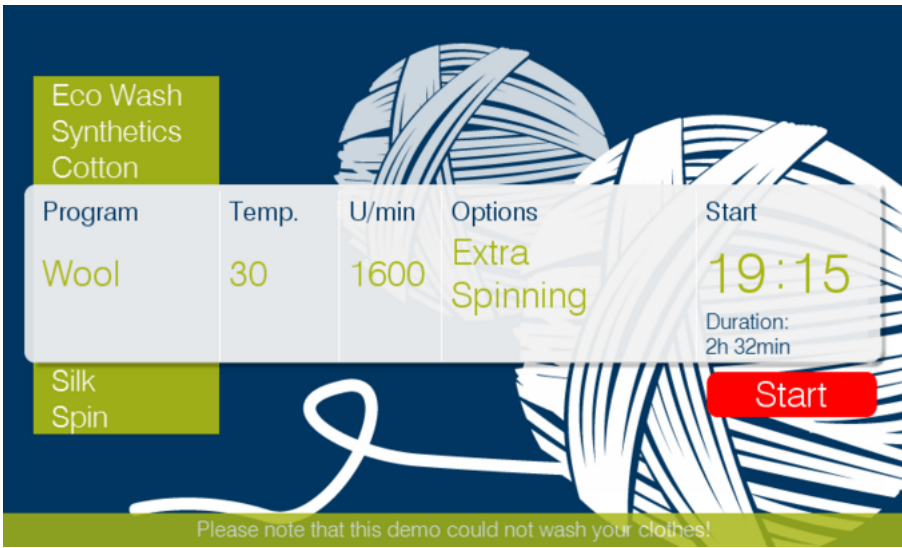
Listed below are some of the provided demos:

| Demo name                         | Screenshot   |
|-----------------------------------|--|
| <p><b>Temperature Control</b></p> |   |
| <p><b>Washing Machine</b></p>     |  |

| Demo name               | Screenshot   |
|-------------------------|--|
| <b>Weather Forecast</b> |  |

## 1.6 Starter kits

Complete starter kits including a demo board with a display, a C compiler and an example project are available. For more details, take a look at our website at [www.segger.com](http://www.segger.com).

## 1.7 AppWizard

With emWin's newest tool AppWizard, users are able to create complete and ready-to-run emWin applications. It incorporates many of emWin's core features such as widgets, animations, language management and motion support to be able to create stunning applications without writing any line of code. Therefore, no knowledge of the C language is required.

More information about AppWizard can be read under *AppWizard* on page 80 or on [our website](#).

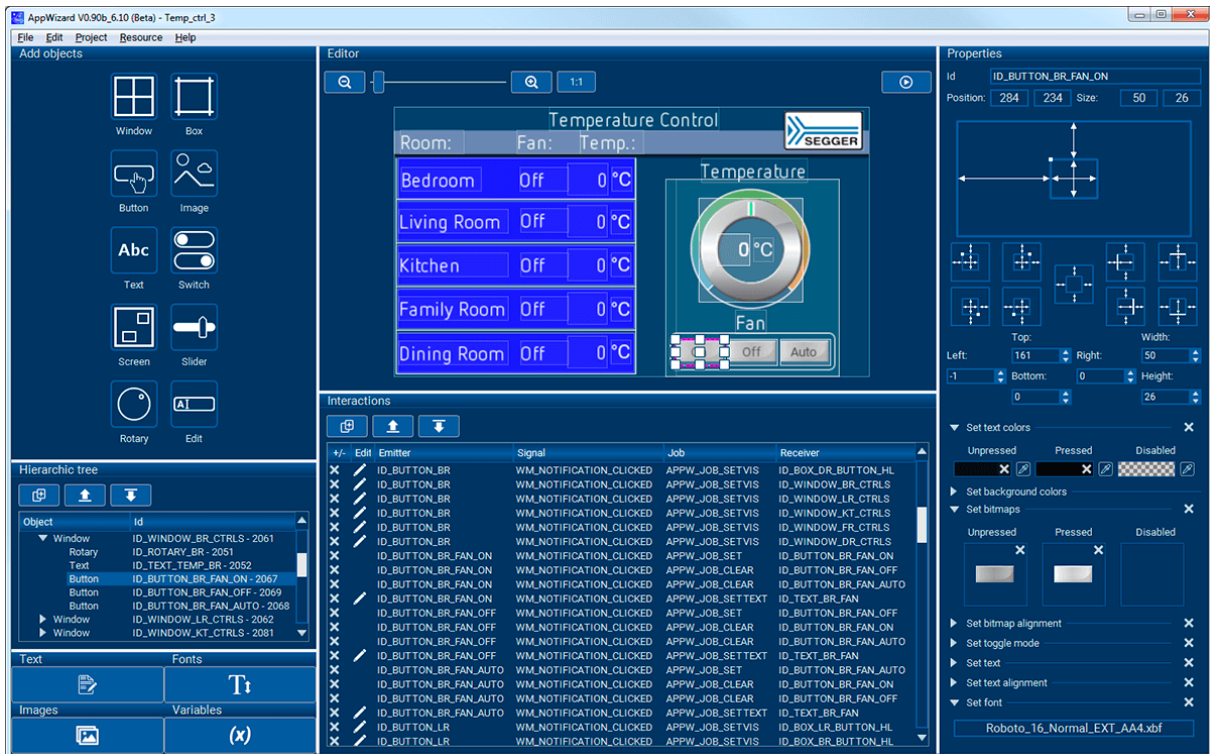

## 1.8 Screen and coordinates

The screen consists of many dots that can be controlled individually. These dots are called pixels. Most of the text and drawing functions that emWin offers in its API to the user program can write or draw on any specified pixel.

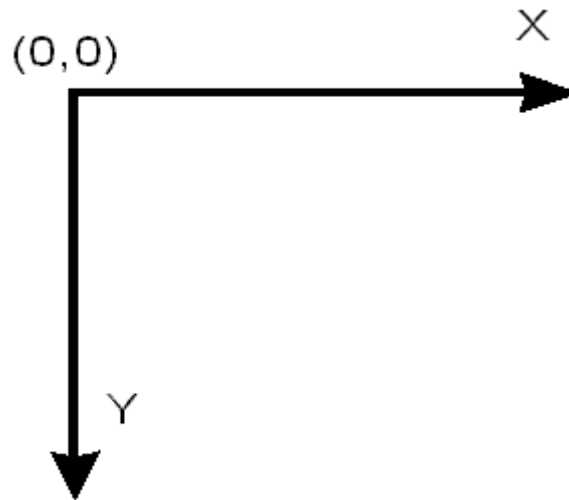

The horizontal scale is called the X-axis, whereas the vertical scale is called the Y-axis. Coordinates are denoted as a pair consisting of an X- and a Y-value (X, Y). The X-coordinate is always first in routines that require X and Y coordinates. The upper left corner of the display (or a window) has per default the coordinates (0,0). Positive X-values are always to the right; positive Y-values are always down. The above graph illustrates the coordinate system and directions of the X- and Y- axes. All coordinates passed to an API function are always specified in pixels.

## 1.9 How to connect the display to the microcontroller

emWin handles all access to the display. Virtually any display controller can be supported, independently of how it is accessed. For details, refer to the chapter *Configuration* on page 100. Also, get in contact with us if your display controller is not supported. We are currently writing drivers for all display controllers available on the market and may already have a proven driver for the display controller that you intend to use. It is usually very simple to write the routines (or macros) used to access the display in your application. SEGGER Microcontroller GmbH offers the service of making these customizations for you, if necessary with your target hardware. It does not really matter how the display is connected to the system as long as it is somehow accessible by software, which may be accomplished in a variety of ways. Most of these interfaces are supported by a driver which is supplied in source code form. This driver does not normally require modifications, but is configured for your hardware by making changes in the file `LCDConf.h`. Details about how to customize a driver to your hardware as necessary are provided in the chapter *Display drivers* on page 2927. The most common ways to access the display are described as follows. If you simply want to understand how to use emWin, you may skip this section.

### Display with memory-mapped display controller:

The display controller is connected directly to the data bus of the system, which means the controller can be accessed just like a RAM. This is a very efficient way of accessing the display controller and is most recommended. The display addresses are defined to the segment `LCDSEG`, and in order to be able to access the display the linker/locator simply needs to be told where to locate this segment. The location must be identical to the access address in physical address space. Drivers are available for this type of interface and for different display controllers.

### Display with display controller connected to port / buffer

For slower display controllers used on fast processors, the use of port-lines may be the only solution. This method of accessing the display has the disadvantage of being somewhat slower than direct bus-interface but, particularly with a cache that minimizes the accesses to the display, the display update is not slowed down significantly. All that needs to be done is to define routines or macros which set or read the hardware ports/buffers that the display is connected to. This type of interface is also supported by different drivers for the different display controllers.

### Proprietary solutions: display without display controller

The display can also be connected without an display controller. In this case, the display data is usually supplied directly by the controller via a 4- or 8-bit shift register. These proprietary hardware solutions have the advantage of being inexpensive, but the disadvantage of using up much of the available computation time. Depending on the CPU, this can be anything between 20 and almost 100 percent; with slower CPUs, it is really not possible at all. This type of interface does not require a specific display driver because emWin simply places all the display data into the display cache. You yourself must write the hardware-dependent portion that periodically transfers the data in the cache memory to your display.

## 1.10 Data types

Since C does not provide data types of fixed lengths which are identical on all platforms, emWin uses, in most cases, its own data types as shown in the table below:

| Data type | Definition     | Description                     |
|-----------|----------------|---------------------------------|
| I8        | signed char    | 8-bit signed value              |
| U8        | unsigned char  | 8-bit unsigned value            |
| I16       | signed short   | 16-bit signed value             |
| U16       | unsigned short | 16-bit unsigned value           |
| I32       | signed long    | 32-bit signed value             |
| U32       | unsigned long  | 32-bit unsigned value           |
| I16P      | signed short   | 16-bit (or more) signed value   |
| U16P      | unsigned short | 16-bit (or more) unsigned value |

For most 16/32-bit controllers, the settings will work fine. However, if you have similar defines in other sections of your program, you might want to change or relocate them. A recommended place is in the file `Global.h`.

# Chapter 2

## Getting Started

---

The following chapter provides an overview of the basic procedures for setting up and configuring emWin on your target system. It also includes a simple program example. If you find yourself unsure about certain areas, keep in mind that most topics are treated in greater detail in later chapters. You will most likely need to refer to other parts of the manual before you begin more complicated programming.



## 2.1 Recommended project structure

We recommend keeping emWin separate from your application files. It is good practice to keep all the program files (including the header files) together in the GUI subdirectories of your project's root directory. The directory structure should be similar to the one seen in the picture. This practice has the advantage of being very easy to update to newer versions of emWin by simply replacing the GUI\ directories. Your application files can be stored anywhere.

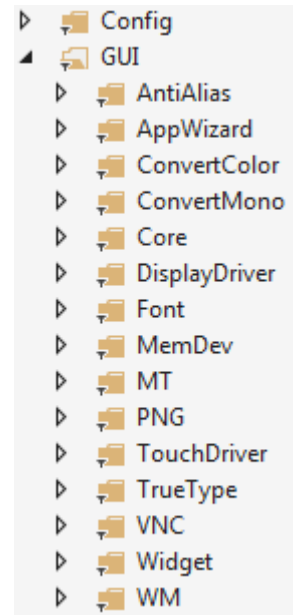

### Note

When updating to a newer emWin version:  
Since files may have been added, moved or deleted, the project directories may need to be updated accordingly.

## 2.2 Subdirectories

The following table shows the contents of all GUI subdirectories. Components marked with \* are optional.

| Directory         | Contents  |
|-------------------|---|
| Config            | Configuration files                                     |
| GUI\AntiAlias     | Antialiasing support *                                  |
| GUI\AppWizard     | AppWizard files   |
| GUI\ConvertMono   | Color conversion routines used for grayscale displays * |
| GUI\ConvertColor  | Color conversion routines used for color displays *     |
| GUI\Core          | emWin core files  |
| GUI\Font          | Font files  |
| GUI\DisplayDriver | Display driver  |
| GUI\MemDev        | Memory Device support *                                 |
| GUI\MT            | MultiTouch support                                      |
| GUI\VNC           | VNC support *   |
| GUI\Widget        | Widget library *  |
| GUI\WM            | Window Manager *  |

### 2.2.1 Include directories

You should make sure that the include path contains the following directories (the order of inclusion is of no importance):

- Config
- GUI\AppWizard
- GUI\Core
- GUI\DisplayDriver
- GUI\Widget (if using the widget library)
- GUI\WM (if using Window Manager)

#### Note

Always make sure that you have only one version of each file!

It is frequently a major problem when updating to a new version of emWin if you have old files included and therefore mix different versions. If you keep emWin in the directories as suggested (and only in these), this type of problem cannot occur. When updating to a newer version, you should be able to keep your configuration files and leave them unchanged. For safety reasons, we recommend backing up (or at least renaming) the GUI\ directories prior to updating.

## 2.3 Adding emWin to the target program

You basically have a choice between including only the source files that you are actually going to use in your project, which will then be compiled and linked, or creating a library and linking the library file. If your tool chain supports "smart" linking (linking in only the modules that are referenced and not those that are not referenced), there is no real need to create a library at all, since only the functions and data structures which are required will be linked. If your tool chain does not support "smart" linking, a library makes sense, because otherwise everything will be linked in and the program size will be excessively large. For some CPUs, we have example projects available to help you get started.

## 2.4 Creating a library

Building a library from the sources is a simple procedure. The first step is to copy the batch files (located under `Sample\Makelib`) into your project's root directory. That means the parent directory containing the `Config` and the `GUI` folder. Then, make any necessary changes. There are a total of four batch files which need to be copied, described in the table below. The main file, `Makelib.bat`, will be the same for all systems and requires no changes. To build a library for your target system, you will normally need to make slight modifications to the other three smaller files. Finally, start the file `Makelib.bat` to create the library. The batch files assume that your `GUI` and `Config` subdirectories are set up as recommended.

The procedure for creating a library is illustrated in the flow chart below. The `Makelib.bat` file first calls `Prep.bat` to prepare the environment for the tool chain. Then it calls `CC.bat` for every file to be included in the library. It does this as many times as necessary. `CC.bat` adds each object file to a list that will be used by `lib.bat`. When all files to be added to the library have been listed, `Makelib.bat` then calls `lib.bat`, which uses a librarian to put the listed object files into the actual library. Of course you are free to create libraries in another way.

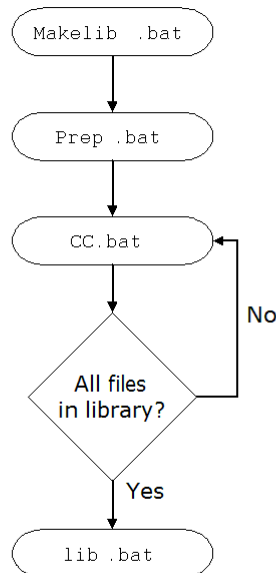

It is not recommended to create an emWin library including a compile-time configurable display driver. Detailed information about the configurability of emWin display drivers can be found in the section *Available display drivers* on page 2928.

| File                     | Description  |
|--------------------------|--|
| <code>Makelib.bat</code> | Main batch file. No modification required.   |
| <code>Prep.bat</code>    | Called by <code>Makelib.bat</code> to prepare environment for the tool chain to be used.   |
| <code>CC.bat</code>      | Called by <code>Makelib.bat</code> for every file to be added to the library; creates a list of these object files which will then be used in the next step by the librarian in the <code>lib.bat</code> file. |
| <code>Lib.bat</code>     | Called by <code>Makelib.bat</code> to put the object files listed by <code>CC.bat</code> into a library.   |

The files as shipped assume that a Microsoft compiler is installed in its default location. If all batch files are copied to the root directory (directly above `GUI`) and no changes are made

at all, a simulation library will be generated for the emWin simulation. In order to create a target library, however, it will be necessary to modify `Prep.bat`, `CC.bat` and `lib.bat`.

## 2.4.1 Adapting the library batch files to a different system

The following will show how to adapt the files by an example adaptation for the ARM Cortex-M4 CPU.

### Adapting Prep.bat

`Prep.bat` is called at the beginning of `Makelib.bat`. As described above its job is to set the environment variables for the used tools and the environment variable `PATH`, so that the batch files can call the tools without specifying an absolute path. Assuming the compiler is installed in the folder `C:\MTOOL` the file `Prep.bat` could look as follows:

```
@ECHO OFF
GOTO START

*****
*
* File      : Prep.bat
* Parameters: None
* Purpose   : Sets path and other environment variables as required by tool chain
*
* This file is written for the CM4 GCC toolchain
*
* It needs to be modified if the compiler is installed in a different location.
*
*****

:START
ECHO PREP.BAT:           Preparing environment for CM4 GCC

if "%_PREP_CM4_GCC%" == "_PREP_CM4_GCC_" goto cont
set _PREP_CM4_GCC=_PREP_CM4_GCC_

SET TOOLPATH=c:\Tool\C\Segger\SES_V452\
set PATH=%TOOLPATH%\gcc\arm-none-eabi\bin\;%PATH%
SET GNU_C_INCLUDE=%TOOLPATH%\include
:cont
```

### Adapting CC.bat

The job of `CC.bat` is to compile the passed source file and adding the file name of the object file to a link list. When starting `MakeLib.bat` it creates the following subdirectories relative to its position:

| Directory   | Contents   |
|-------------|--|
| Lib         | This folder should contain the library file after the build process.   |
| Temp\Output | Should contain all the compiler output and the link list file. Will be deleted after the build process.  |
| Temp\Source | <code>MakeLib.bat</code> uses this folder to copy all source and header files used for the build process. Will be deleted after the build process. |

The object file should be created (or moved) to `Temp\Output`. This makes sure all the output will be deleted after the build process. Also the link list should be located in the output folder. The following shows an example for the GCC compiler:

```
@ECHO OFF
GOTO START
```

```

*****
*
* File      : CC.bat
* Parameters: %1 Name of file to compile (without extension; .c is added)
* Purpose   : Compile one file and add it to the list of files to put in
*           : Library
*
* This file as is uses the GCC Compiler
*
*****

:START
ECHO CC.BAT:           Compiling %1.c with GCC compiler

if "%COMPILER_TEST_SAMPLES%"=="1" (
    ccl -mthumb -mcpu=cortex-m4 -mlittle-endian -mfpv4-sp-d16 -mfloat-abi=softfp -DDEBUG=1 -DSKIP_TEST -O3 -mfpv4-sp-d16 -mfloat-abi=softfp -fomit-frame-pointer -quiet -Wall -Wno-missing-field-initializers -Wextra -nostdinc "-I %GNU_C_INCLUDE%" -D__CROSSWORKS_ARM -fno-builtin -o temp/Output/%1.l temp/Source/%1.c
) else (
    ccl -mthumb -mcpu=cortex-m4 -mlittle-endian -mfpv4-sp-d16 -mfloat-abi=softfp -DDEBUG=1 -DSKIP_TEST -O3 -mfpv4-sp-d16 -mfloat-abi=softfp -fomit-frame-pointer -quiet -Wall -Wextra -Wlogical-op -Wfloat-equal -pedantic -nostdinc "-I %GNU_C_INCLUDE%" -D__CROSSWORKS_ARM -fno-builtin -o temp/Output/%1.l temp/Source/%1.c
)

IF ERRORLEVEL 1 PAUSE
as -mthumb -mcpu=cortex-m4 -mlittle-endian -mfpv4-sp-d16 -mfloat-abi=softfp -mfpv4-sp-d16 -mfloat-abi=softfp --traditional-format -EL "temp/Output/%1.l" -o "temp/Output/%1.o"
IF ERRORLEVEL 1 PAUSE
IF NOT EXIST temp\Lib.dat @ECHO create lib/libGUI.a>temp\Lib.dat
@ECHO addmod temp\output\%1.o>>temp/lib.dat

```

## Adapting Lib.bat

After all source files have been compiled Lib.bat will be called from MakeLib.bat. The job is to create a library file using the link list created by CC.bat. The destination folder of the library file should be the Lib folder created by MakeLib.bat. The following shows an example for the GCC toolchain:

```

@ECHO OFF
GOTO START

*****
*
* File      : Lib.bat
* Parameters: None
* Purpose   : Put all (object) files in linklist into the library
*
* This file is written for the GCC toolchain
*
*****

:START

ECHO MAKELIB.BAT:           Creating GUI target library using GCC tool-chain

REM *****
REM   Create library
REM *****

IF EXIST Lib\GUI_GNU.LIB DEL Lib\GUI_GNU.LIB
@ECHO save>>temp\lib.dat
@ECHO end>>temp\lib.dat
ar -M<temp/lib.dat

```

```
IF ERRORLEVEL 1 PAUSE
```

## 2.5 C files to include in the project

Generally speaking, you need to include the core C files of emWin, the display driver, all font files you plan to use and any optional modules you have ordered with emWin:

- All C files of the folder `Config`
- All C files of the folder `GUI\Core`
- The fonts you plan to use (located in `GUI\Font`)
- Display driver: All C files of the folder `GUI\DisplayDriver`.

### Additional software packages

If you plan to use additional, optional modules you must also include their C files:

- Gray scale converting functions: all C files located in `GUI\ConvertMono`
- Color conversion functions: all C files located in `GUI\ConvertColor`
- Antialiasing: all C files located in `GUI\AntiAlias`
- AppWizard: all C files located in `GUI\AppWizard`
- Memory Devices: all C files located in `GUI\MemDev`
- VNC support: all C files located in `GUI\VNC`
- Widget library: all C files located in `GUI\Widget`
- Window Manager: all C files located in `GUI\WM`

### Target specifics

For displays with indirect interface hardware routines must be included. Examples for several kinds of indirect interface routines are available under `Sample\LCD_X_Port`.

### RTOS specifics

- If emWin is intended to be used with an RTOS, some RTOS dependent functions need to be implemented. emWin comes with several sample files including implementations for common RTOS packages (called `GUI_X_<RTOS>.c`), as well as the file `GUI_X_Ex.c` which just contains place holders of the required functions and might be used to make emWin work with any RTOS.
- If multitasking is not required (access of the display by one task only) the file `GUI_X.c` may be used as a starting point for a custom implementation. The sample files can be found in the folder `Sample\GUI_X` which is contained in the emWin package.

### Additional information

Be sure to include `GUI.h` in all emWin accessing source files.



## 2.6 Configuring emWin

The `Config` folder should contain all configuration files. The chapter *Configuration* on page 100 explains in detail how emWin should be configured.

### 2.6.1 Configuration macros

The following types of configuration macros are available:

#### Binary switch "B"

Switches can have a value of either 0 or 1, where 0 means deactivated and 1 means activated (actually anything other than 0 would work, but using 1 makes it easier to read a config file). These switches can enable or disable a certain functionality or behavior. Switches are the simplest form of configuration macro.

#### Numerical value "N"

Numerical values are used somewhere in the code in place of a numerical constant. Typical examples are in the configuration of the resolution of a display.

#### Selection switch "S"

Selection switches are used to select one out of multiple options where only one of those options can be selected. A typical example might be the selection of the type of display controller used, where the number selected denotes which source code (in which display driver) is used to generate object code.

#### Alias "A"

A macro which operates like a simple text substitute. An example is `U8`, which is replaced by the preprocessor with `unsigned char`.

#### Function replacement "F"

Macros can basically be treated like regular functions although certain limitations apply, as a macro is still put into the code as simple text replacement. Function replacements are mainly used to add specific functionality to a module (such as the access to a display) which is highly hardware-dependent. This type of macro is always declared using brackets (and optional parameters).

#### Type replacement "T"

Type replacement macros allow changing the types of certain values.

## 2.7 Initializing emWin

The following functions should be used to initialize and 'de-initialize' emWin in order to start the configuration process (see chapter *Configuration* on page 100) or clear internal data from memory again.

| Routine                          | Description   |
|----------------------------------|---|
| <code>GUI_Init()</code>          | Initializes emWin internal data structures and variables.   |
| <code>GUI_IsInitialized()</code> | Returns the initialization state of emWin.  |
| <code>GUI_Exit()</code>          | Clears emWin internal data from memory to make further calls of <code>GUI_Init()</code> possible. |

### Code example

The section *The Hello world example program* on page 99 offers a code example that shows how emWin is initialized.

## 2.7.1 GUI\_Init()

### Description

Initializes emWin internal data structures and variables.

### Prototype

```
int GUI_Init(void);
```

### Return value

= 0        if successful.  
≠ 0        if the initialization of the display driver fails.

### Additional information

Executing this function is mandatory before using any emWin functions. The only exception is setting create flags for windows (see `WM_SetCreateFlags()`). If the Window Manager is used, the background window is created from within `GUI_Init()`. So if create flags are set up before `GUI_Init()` is called, the background window is created according to them.

## 2.7.2 GUI\_IsInitialized()

### Description

Returns the initialization state of emWin.

### Prototype

```
int GUI_IsInitialized(void);
```

### Return value

|   |                                 |
|---|---------------------------------|
| 1 | if emWin is already initialized |
| 0 | if not.                         |

## 2.7.3 GUI\_Exit()

### Description

Clears emWin internal data from memory to make further calls of `GUI_Init()` possible.

### Prototype

```
void GUI_Exit(void);
```

### Additional information

This function should be used if emWin represents a part of the application which is not used continuously and therefore has to be able to be turned on and off again. Please note that after `GUI_Exit()` was called emWin will not work properly until `GUI_Init()` is called again.

## 2.8 Using emWin with target hardware

The following is just a basic outline of the general steps that should be taken when starting to program with emWin. All steps are explained further in subsequent chapters.

### Step 1: Configuring emWin

The first step is usually to customize emWin. For details about the configuration, refer to the chapter *Configuration* on page 100.

### Step 2: Defining access addresses or access routines

For memory-mapped display controllers, the access addresses of the display simply need to be defined in the configuration file of the display controller. For port/buffer-accessed display controllers, interface routines must be defined. Examples of the required routines are available under `Sample\LCD_X_Port`.

### Step 3: Compiling, linking and testing the example code

emWin comes with example code for both single- and multitask environments. Compile, link and test these little example programs until you feel comfortable doing so.

### Step 4: Modifying the example program

Make simple modifications to the example programs. Add additional commands such as displaying text in different sizes on the display, showing lines and so on.

### Step 5: In multitask applications: adapt to your OS (if necessary)

If multiple tasks should be able to access the display simultaneously, the macros `GUI_MAX-TASK` and `GUI_OS` come into play, as well as the file `GUItask.c`. For details and example adaptations, refer to the chapter *Configuration* on page 100.

### Step 6: Write your own application using emWin

By now you should have a clearer understanding of how to use emWin. Think about how to structure the program your application requires and use emWin by calling the appropriate routines. Consult the reference chapters later in this manual, as they discuss the specific emWin functions and configuration macros that are available.

## 2.9 The "Hello world" example program

In the following we will show the "Hello world" example program. If you like to see a wide range of emWin based sample applications as well as further simple tutorial applications, please have a look in the `Sample` folder of your emWin shipment or visit the "emWin Samples" section on [www.segger.com](http://www.segger.com).

A "Hello world" program has been used as a starting point for C programming since the early days, because it is essentially the smallest program that can be written. An emWin "Hello world" program is shown below and is available as `BASIC>HelloWorld.c` in the `Sample\Tutorial` folder shipped with emWin. The whole purpose of the program is to write "Hello world" in the upper left corner of the display. In order to be able to do this, the hardware of the application, the display controller and the GUI must be initialized first. emWin is initialized by a simple call of `GUI_Init()` in the beginning of the program. In this example, we assume that the hardware of your application is already initialized. The "Hello world" program looks as follows:

```
#include "GUI.h"
void MainTask(void) {
    GUI_Init();
    GUI_DispString("Hello world!");
    while(1);
}
```

### Adding functionality to the "Hello world" program

Our little program has not been doing too much so far. We can now extend the functionality a bit: after displaying "Hello world", we would like the program to start counting on the display in order to be able to estimate how fast outputs to the display can be made. We can simply add a bit of code to the loop at the end of the main program, which is essentially a call to the function that displays a value in decimal form.

The example is available as `BASIC>Hello1.c` in the `Sample` folder.

```
#include "GUI.h"
void MainTask(void) {
    int i = 0;
    GUI_Init();
    GUI_DispString("Hello world!");
    while(1) {
        GUI_DispDecAt( i++, 20,20,4);
        if (i > 9999) {
            i = 0;
        }
    }
}
```

# Chapter 3

## Configuration

---

Before emWin can be used on a target system, the software needs to be configured. Configuring means modifying the configuration files which usually reside in the (sub)directory `Config`. We try to keep the configuration as simple as possible, but there are some configuration routines which need to be modified in order for the system to work properly.

The following items need to be configured:

- Memory area to be used by emWin
- Display driver to be used for drawing operations
- Color conversion routines to be used
- Display controller initialization
- Hardware acceleration
- Hardware JPEG decoding

The following chapter explains the configuration of emWin in detail.



## 3.1 What needs to be configured?

The configuration is basically divided into two parts: GUI-configuration and LCD-configuration. GUI-configuration means configuration of available features, default colors and - fonts and the configuration of available memory. The LCD-configuration is more hardware dependent and has to define the physical size of the display, the display driver and the color conversion routines to be used. For details about color conversion routines, refer to the chapter *Colors* on page 478.

If a hardware is used which offers acceleration features as for example available with the ChromeART accelerator of some of the STM32 devices, the chapter *Hardware acceleration* on page 131 contains more information.

A further part is configuring the simulation. But this is not required for the target hardware and not part of this chapter. For details about configuring the simulation, refer to the chapter *Simulation* on page 166.

## 3.2 Run-time- and compile-time configuration

There are C and include files to be configured. The configuration in the header files is fixed at compile time and can not be changed whereas the configuration done in the C files can be changed at run-time. This makes it possible to create a library which is largely configuration independent and can be used with any display and any driver. This requires that the configuration routines described in this chapter are not part of the library but of the application.

### 3.3 Initialization process of emWin

The illustration shows the process of initialization. To initialize emWin, the application only has to call `GUI_Init()`. The configuration routines explained below are called during the internal initialization process.

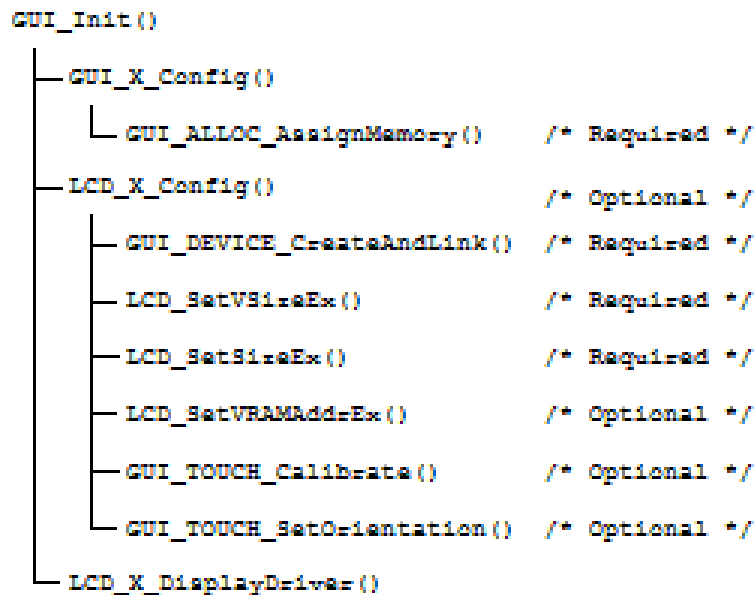

#### GUI\_X\_Config()

It is called at the very first beginning of the initialization process to make sure that memory is assigned to emWin. Within this routine `GUI_ALLOC_AssignMemory()` must be called to assign a memory block to emWin. The functions are explained later in this chapter.

#### LCD\_X\_Config()

This function is called immediately after `GUI_X_Config()`. The main purpose of this routine is creating a display driver device and selecting the color conversion routines. Further it is responsible for setting the display size. If a touch screen is used it should also be configured here.

#### LCD\_X\_DisplayDriver()

At a later point of the initialization process the function `LCD_X_DisplayDriver()` is called. It is called directly by the display driver. During the initialization process the task of this routine is putting the display controller into operation. A detailed description of the routine follows later in this chapter.

## 3.4 Run-time configuration

The following table shows the available run-time configuration files located in the subfolder Config:

| Configuration file | Purpose  |
|--------------------|--|
| GUIConf.c          | Configuration of available memory.   |
| LCDConf.c          | Configuration of the display size, the display driver and the color conversion routines. |
| SIMConf.c          | Configuration of the simulation (not part of this chapter).                              |
| GUI_X.c            | Configuration of timing routines.  |

### 3.4.1 Customizing GUIConf.c

The purpose of this module is to provide emWin with the function `GUI_X_Config()` which is responsible for assigning a memory block to the memory management system. This requires knowledge about the memory requirement of the used components. The separate chapter Performance and Resource Usage contains a detailed description of the memory requirements (RAM and ROM) of the individual emWin modules.

Per default GUIConf.c is located in the (sub)directory and contains the routine `GUI_X_Config()` which is responsible to assign a memory block to emWin. It is not cogently required to leave it in the file GUIConf.c. The routine `GUI_X_Config()` can be located anywhere in the application.

Calling this function is the very first thing done during the process of initialization. It is responsible to assign a memory block to emWin. This block is managed by the internal memory management system. Please also refer to `GUI_ALLOC_AssignMemory()`.

#### 3.4.1.1 API functions to be used in GUI\_X\_Config()

The following table shows the API functions which must be called within `GUI_X_Config()`:

| Routine                                  | Description   |
|--|---|
| <code>GUI_ALLOC_AssignMemory()</code>    | The function assigns the one and only memory block to emWin which is used by the internal memory management system. |
| <code>GUI_RegisterAfterInitHook()</code> | Registers a hook function which gets called after the GUI has been initialized.                                     |
| <code>GUI_SetOnErrorFunc()</code>        | Sets the hook function which is called from <code>GUI_ErrorOut()</code> .   |
| <code>GUI_SetOnLogFunc()</code>          | Sets the hook function which is called from <code>GUI_Log()</code> .  |
| <code>GUI_SetOnWarnFunc()</code>         | Sets the hook function which is called from <code>GUI_Warn()</code> .   |
| <code>GUI_TASK_GetMaxTask()</code>       | Returns the maximum number of possible tasks when multitasking is enabled.  |
| <code>GUI_TASK_SetMaxTask()</code>       | Sets the maximum number of tasks from which emWin can be accessed when multitasking is enabled.                     |

### 3.4.1.1.1 GUI\_ALLOC\_AssignMemory()

#### Description

The function assigns the one and only memory block to emWin which is used by the internal memory management system. This function should be called typically from GUI\_X\_Config().

#### Prototype

```
void GUI_ALLOC_AssignMemory(void * p,
                             U32   NumBytes);
```

#### Parameters

| Parameter             | Description  |
|-----------------------|--|
| <code>p</code>        | Pointer to the memory block which should be used by emWin. |
| <code>NumBytes</code> | Size of the memory block in bytes.                         |

#### Additional information

Note that not the complete memory block can be used by the application, because a small overhead is used by the management system itself. Each memory block requires approximately 12 additional bytes for management purpose. The assigned memory block needs to be accessible 8, 16 and 32 bit wise. It is used by emWin internally for memory allocation. Instead of using malloc() and free() the internal memory management uses that block for memory allocation. It is not used as frame buffer.

### 3.4.1.1.2 GUI\_RegisterAfterInitHook()

#### Description

Registers a hook function which gets called after the GUI has been initialized.

#### Prototype

```
void GUI_RegisterAfterInitHook(void (*pFunc)(),
                               GUI_REGISTER_INIT * pRegisterInit);
```

#### Parameters

| Parameter                  | Description                               |
|----------------------------|---|
| <code>pFunc</code>         | Pointer to a function to be called.       |
| <code>pRegisterInit</code> | Pointer to a GUI_REGISTER_INIT structure. |

#### Additional information

It is possible to set multiple function to be called after the GUI has been initialized. This requires a dedicated GUI\_REGISTER\_INIT structure for each function.

```
static void _Init0(void) {
}
static void _Init1(void) {
}
void GUI_X_Config(void) {
    static GUI_REGISTER_INIT RegisterInit0;
    static GUI_REGISTER_INIT RegisterInit1;

    static U32 aMemory[GUI_NUMBYTES / 4];
    GUI_ALLOC_AssignMemory(aMemory, GUI_NUMBYTES);
    GUI_SetDefaultFont(&GUI_Font6x8);
    GUI_RegisterAfterInitHook(_Init0, &RegisterInit0);
    GUI_RegisterAfterInitHook(_Init1, &RegisterInit1);
}
```

### 3.4.1.1.3 GUI\_SetOnErrorFunc()

#### Description

Sets the hook function which is called from `GUI_ErrorOut()`.

#### Prototype

```
void GUI_SetOnErrorFunc(void (*pFunc)(const char * s));
```

#### Parameters

| Parameter          | Description   |
|--------------------|---|
| <code>pFunc</code> | Pointer to the function which should be called by <code>GUI_ErrorOut()</code> . |

#### Additional information

The hook function gets a short error description in the string passed to the routine. It should contain the module and the function where the error occurred and a short description.

See also the description of `GUI_ErrorOut()`.

### 3.4.1.1.4 GUI\_SetOnLogFunc()

#### Description

Sets the hook function which is called from `GUI_Log()`.

#### Prototype

```
void GUI_SetOnLogFunc(void ( *pFunc)(const char * s ));
```

#### Parameters

| Parameter          | Description  |
|--------------------|--|
| <code>pFunc</code> | Pointer to the function which should be called by <code>GUI_Log()</code> . |

#### Additional information

The hook function gets a log message in the string passed to the routine. The string contains the module and the function from where the log was sent.

See also the description of `GUI_Log()`.



### 3.4.1.1.5 GUI\_SetOnWarnFunc()

#### Description

Sets the hook function which is called from GUI\_Warn().

#### Prototype

```
void GUI_SetOnWarnFunc(void ( *pFunc)(const char * s ));
```

#### Parameters

| Parameter          | Description   |
|--------------------|---|
| <code>pFunc</code> | Pointer to the function which should be called by GUI_Warn(). |

#### Additional information

The hook function gets a warning in the string passed to the routine. The string contains the module and the function where the error occurred and a short description.

See also the description of GUI\_Warn().

### 3.4.1.1.6 GUITASK\_GetMaxTask()

#### Description

Returns the maximum number of possible tasks when multitasking is enabled.

#### Prototype

```
int GUITASK_GetMaxTask(void);
```

#### Return value

Maximum number of possible tasks.

### 3.4.1.1.7 GUITASK\_SetMaxTask()

#### Description

Sets the maximum number of tasks from which emWin can be accessed when multitasking is enabled.

#### Prototype

```
void GUITASK_SetMaxTask(int MaxTask);
```

#### Parameters

| Parameter | Description                                       |
|-----------|---|
| MaxTask   | Number of tasks from which emWin is used at most. |

#### Additional information

This function is intended to be called from `GUI_X_Config()`. It is necessary to use this function when working with a pre-compiled library. Otherwise `GUI_MAXTASK` can be defined. Further information can be found under `GUI_MAXTASK` on page 2888.

## 3.4.2 Customizing LCDConf.c

The purpose of this module is to provide emWin with the required display configuration routine and the callback function for the display driver. These are the following functions:

| Routine                            | Description   |
|------------------------------------|---|
| <code>LCD_X_Config()</code>        | Configuration routine for creating the display driver device, setting the color conversion routines and the display size. |
| <code>LCD_X_DisplayDriver()</code> | Callback routine called by the display driver for putting the display controller into operation.                          |

### 3.4.2.1 LCD\_X\_Config()

#### Description

As described in the table above this routine is responsible to create a display driver device, set the right color conversion routines and for configuring the physical display size.

#### Prototype

```
void LCD_X_Config(void);
```

#### Additional information

Depending on the used display driver it could also be required to set the video RAM address, initialize a custom palette or some else. For information about any additional requirements, refer to *Detailed display driver descriptions* on page 2961. The functions available for configuration purpose in this routine are listed and explained later in this chapter.

#### Example

The following shows a typical example implementation:

```
//  
// Set display driver and color conversion for 1st layer  
//  
GUI_DEVICE_CreateAndLink(GUIDRV_LIN_16, GUICC_565, 0, 0);  
//  
// Display driver configuration  
//  
LCD_SetSizeEx    (0, 320, 240);  
LCD_SetVSizeEx  (0, 320, 240);  
LCD_SetVRAMAddrEx(0, (void *)0x200000);
```

### 3.4.2.2 LCD\_X\_DisplayDriver()

#### Description

This is the callback function of the display driver. It is called by the display driver for several jobs. It passes a command and a pointer to a data structure to the callback routine. The command tells the callback function what should be done. If the command requires parameters they are passed through the data pointer `pData`. It points to a structure whose format depends on the command.

#### Prototype

```
int LCD_X_DisplayDriver(unsigned LayerIndex,
                      unsigned Cmd,
                      void * pData);
```

#### Parameters

| Parameter               | Description  |
|-------------------------|--|
| <code>LayerIndex</code> | Zero based layer index.                              |
| <code>Cmd</code>        | Command to be executed. Detailed descriptions below. |
| <code>pData</code>      | Pointer to a data structure.                         |

#### Elements of structure LCD\_X\_SETVRAMADDR\_INFO

| Data type           | Element            | Description                                    |
|---------------------|--------------------|--|
| <code>void *</code> | <code>pVRAM</code> | Pointer to the start address of the video RAM. |

#### Return value

- 0 Command has been successfully executed.
- 1 Command is not handled by the function.
- 2 Error occurred.

#### Additional information

For more information about the commands passed to the routine by the display driver, refer to *Display drivers* on page 2927.

#### Examples

The folder `Sample\LCDConf` contains a lot of example implementations of this routine which can be used as starting point.

### 3.4.2.3 API functions to be used in LCD\_X\_Config()

The following table shows the API functions which are available for configuration purpose within `LCD_X_Config()`:

| Routine                                 | Description  |
|---|--|
| <code>GUI_DEVICE_CreateAndLink()</code> | Creates a display driver device and associates the color conversion routines to be used. |
| <code>GUI_TOUCH_SetOrientation()</code> | The function configures the touch screen orientation.                                    |
| <code>GUI_TOUCH_Calibrate()</code>      | Changes the calibration at runtime.  |
| <code>LCD_SetLUTEx()</code>             | Sets the look-up table for the given layer.  |
| <code>LCD_SetSizeEx()</code>            | Sets the physical size of the visible area of the given display/layer.                   |
| <code>LCD_SetVRAMAddrEx()</code>        | Sets the address of the video RAM.   |
| <code>LCD_SetVSizeEx()</code>           | Sets the size of the virtual display area.   |

Aside from the function `LCD_SetLUTEx()` the descriptions of the `LCD_...()` functions can be found in the chapter *Display drivers* on page 2927.

The descriptions of the `GUI_TOUCH_...()` functions can be found in the chapter *Touch screen driver* on page 686.

### 3.4.2.3.1 GUI\_DEVICE\_CreateAndLink()

#### Description

This routine creates the display driver device, sets the color conversion routines to be used for accessing the display and it links the driver device into the device list of the given layer. `LCD_X_Config()` is called immediately after `GUI_X_Config()`. This makes sure that the memory configuration already has been done and the driver is able to allocate memory. The required memory for a display driver device is approx. 50 bytes + the driver specific memory. For details about the memory requirements of the individual display drivers, refer to the chapter *Display drivers* on page 2927.

#### Prototype

```
GUI_DEVICE *GUI_DEVICE_CreateAndLink(const GUI_DEVICE_API    * pDeviceAPI,
                                     const LCD_API_COLOR_CONV * pColorConvAPI,
                                     U16                       Flags,
                                     int                       LayerIndex);
```

#### Parameters

| Parameter                  | Description   |
|----------------------------|---|
| <code>pDeviceAPI</code>    | Pointer to the display driver to be used. The chapter <i>Display drivers</i> on page 2927 contains a table of the available display drivers.              |
| <code>pColorConvAPI</code> | Pointer to the color conversion routines to be used. The chapter <i>Colors</i> on page 478 contains a table with the available color conversion routines. |
| <code>Flags</code>         | Should be zero.   |
| <code>LayerIndex</code>    | Layer which should be managed by the driver.  |

#### Return value

On success the function returns a pointer to the created device object, otherwise it returns NULL.

#### Additional information

Note that the used driver also determines the display orientation in some cases. This differs from driver to driver. For details about the display orientation, refer to the chapter *Display drivers* on page 2927.



### 3.4.3 Customizing GUI\_X.c

This file is the location of the timing routines, the debugging routines and the kernel interface routines:

#### 3.4.3.1 Init routines

##### 3.4.3.1.1 GUI\_X\_Init()

###### Description

This function is being called on initialization of emWin.

###### Prototype

```
void GUI_X_Init(void);
```

###### Additional information

Typically used to initialize a hardware timer to provide a time base used by the timing related GUI\_X functions. This is not required when using an underlying RTOS.

## 3.4.3.2 Timing routines

### 3.4.3.2.1 GUI\_X\_Delay()

#### Description

Returns after a specified time period in milliseconds.

#### Prototype

```
void GUI_X_Delay(int Period);
```

#### Parameters

| Parameter           | Description                          |
|---------------------|--------------------------------------|
| <code>Period</code> | <code>Period</code> in milliseconds. |

### 3.4.3.2.2 GUI\_X\_ExecIdle()

#### Description

Called only from non-blocking functions of the Window Manager.

#### Prototype

```
void GUI_X_ExecIdle(void);
```

#### Additional information

Called when there are no longer any messages which require processing. In this case the GUI is up to date.

### 3.4.3.2.3 GUI\_X\_GetTime()

#### Description

Used by `GUI_GetTime()` to return the current system time in milliseconds.

#### Prototype

```
GUI_TIMER_TIME GUI_X_GetTime(void);
```

#### Return value

The current system time in milliseconds, of type integer.

### 3.4.3.3 Debug routines

#### 3.4.3.3.1 GUI\_X\_ErrorOut()

#### 3.4.3.3.2 GUI\_X\_Warn()

#### 3.4.3.3.3 GUI\_X\_Log()

##### Description

These routines are called by emWin with debug information in higher debug levels in case a problem (Error) or potential problem is discovered. The routines can be blank; they are not required for the functionality of emWin. In a target system, they are typically not required in a release (production) build, since a production build typically uses a lower debug level.

- Fatal errors are output using `GUI_X_ErrorOut()` if `(GUI_DEBUG_LEVEL ≥ 3)`
- Warnings are output using `GUI_X_Warn()` if `(GUI_DEBUG_LEVEL ≥ 4)`
- Messages are output using `GUI_X_Log()` if `(GUI_DEBUG_LEVEL ≥ 5)`

##### Prototypes

```
void GUI_X_ErrorOut(const char * s);
```

```
void GUI_X_Warn(const char * s);
```

```
void GUI_X_Log(const char * s);
```

##### Parameters

| Parameter      | Description                       |
|----------------|-----------------------------------|
| <code>s</code> | Pointer to the string to be sent. |

##### Additional information

This routine is called by emWin to transmit error messages or warnings, and is required if logging is enabled. The GUI calls this function depending on the configuration macro `GUI_DEBUG_LEVEL`. The following table lists the permitted values for `GUI_DEBUG_LEVEL`:

| Value | Symbolic name                             | Description  |
|-------|---|--|
| 0     | <code>GUI_DEBUG_LEVEL_NOCHECK</code>      | No run-time checks are performed.  |
| 1     | <code>GUI_DEBUG_LEVEL_CHECK_PARA</code>   | Parameter checks are performed to avoid crashes. (Default for target system) |
| 2     | <code>GUI_DEBUG_LEVEL_CHECK_ALL</code>    | Parameter checks and consistency checks are performed.                       |
| 3     | <code>GUI_DEBUG_LEVEL_LOG_ERRORS</code>   | Errors are recorded.   |
| 4     | <code>GUI_DEBUG_LEVEL_LOG_WARNINGS</code> | Errors and warnings are recorded. (Default for PC-simulation)                |
| 5     | <code>GUI_DEBUG_LEVEL_LOG_ALL</code>      | Errors, warnings and messages are recorded.                                  |

### 3.4.3.4 Kernel interface routines

Detailed descriptions for these routines may be found in *Execution Model: Single Task / Multitask* on page 2876.

## 3.4.4 Function replacement

The following table shows the API functions which are available for setting up custom defined functions for common purpose:

| Routine                           | Description  |
|-----------------------------------|--|
| <a href="#">GUI_SetpfMemcpy()</a> | Sets a custom function for memcpy operations.              |
| <a href="#">GUI_SetpfMemset()</a> | Sets a custom function for memset operations.              |
| <a href="#">GUI_SetpfStrcmp()</a> | Sets a custom function for string compare operations.      |
| <a href="#">GUI_SetpfStrcpy()</a> | Sets a custom function for string copy operations.         |
| <a href="#">GUI_SetpfStrlen()</a> | Sets a custom function for getting the length of a string. |

### 3.4.4.1 GUI\_SetpfMemcpy()

#### Description

Sets a custom function for memcpy operations.

#### Prototype

```
void GUI_SetpfMemcpy  
    (void * ( *pFunc)(void * pDest , const void * pSrc , size_t Cnt ));
```

#### Parameters

| Parameter          | Description         |
|--------------------|---------------------|
| <code>pFunc</code> | Function to be used |

### 3.4.4.2 GUI\_SetpfMemset()

#### Description

Sets a custom function for memset operations.

#### Prototype

```
void GUI_SetpfMemset(void * ( *pFunc)(void * pDest , int c , size_t Cnt ));
```

#### Parameters

| Parameter          | Description         |
|--------------------|---------------------|
| <code>pFunc</code> | Function to be used |



### 3.4.4.3 GUI\_SetpfStrcmp()

#### Description

Sets a custom function for string compare operations.

#### Prototype

```
void GUI_SetpfStrcmp(int (*pFunc)(const char *, const char *));
```

#### Parameters

| Parameter          | Description         |
|--------------------|---------------------|
| <code>pFunc</code> | Function to be used |

### 3.4.4.4 GUI\_SetpfStrcpy()

#### Description

Sets a custom function for string copy operations.

#### Prototype

```
void GUI_SetpfStrcpy(char * ( *pFunc)(char * , const char * ));
```

#### Parameters

| Parameter          | Description         |
|--------------------|---------------------|
| <code>pFunc</code> | Function to be used |

### 3.4.4.5 GUI\_SetpfStrlen()

#### Description

Sets a custom function for getting the length of a string.

#### Prototype

```
void GUI_SetpfStrlen(size_t ( *pFunc)(const char * ));
```

#### Parameters

| Parameter          | Description         |
|--------------------|---------------------|
| <code>pFunc</code> | Function to be used |

## 3.5 Compile-time configuration

The following table shows the available compile time configuration files located in the sub-folder `Config`:

| Configuration file      | Purpose  |
|-------------------------|--|
| <code>GUIConf.h</code>  | Configuration of possible number of used layers, default fonts and colors and available features (e.g. Widgets). |
| <code>LCDCConf.h</code> | Configuration of the used display driver(s).   |

In case a precompiled emWin library is used, changing the configuration files will not have any effect until the library is compiled again with the required settings. This applies to all of the defines explained in the following sections.

### 3.5.1 Customizing GUIConf.h

As described above the file should contain the configuration of available features and the configuration of the default font. Each emWin shipment comes with a `GUIConf.h` file which includes a basic configuration which can be used as a starting point.

#### 3.5.1.1 Configuring the available features of emWin

The following table shows the available configuration macros:

| Type | Macro                             | Default          | Description  |
|------|-----------------------------------|------------------|--|
| B    | <code>GUI_OS</code>               | 0                | Activate to enable multitasking support with multiple tasks calling emWin (see the chapter <i>Execution Model: Single Task / Multitask</i> on page 2876).  |
| B    | <code>GUI_SUPPORT_CURSOR</code>   | (see expl.)      | Per default cursors are enabled if either <code>GUI_SUPPORT_TOUCH</code> or <code>GUI_SUPPORT_MOUSE</code> has been enabled. If cursors should be shown without enabling one of these options it should be set to 1. |
| B    | <code>GUI_SUPPORT_MEMDEV</code>   | 0                | Enables optional Memory Device support.  |
| B    | <code>GUI_SUPPORT_MOUSE</code>    | 0                | Enables the optional mouse support.  |
| B    | <code>GUI_SUPPORT_ROTATION</code> | 1                | Enables text rotation support.   |
| B    | <code>GUI_SUPPORT_SPY</code>      | 0                | Enables support for emWinSPY.  |
| B    | <code>GUI_SUPPORT_TOUCH</code>    | 0                | Enables optional touch-screen support.   |
| T    | <code>GUI_TIMER_TIME</code>       | <code>int</code> | Defines the type which is used for time values by the emWin Timer functionality.   |
| B    | <code>GUI_WINSUPPORT</code>       | 0                | Enables optional Window Manager support.   |
| B    | <code>GUI_SUPPORT_BIDI</code>     | 1                | Enables BiDi support for emWin. Set to 0 if not required and to save some ROM.   |

#### 3.5.1.2 Default font and default color configuration

The following table shows the available configuration macros:

| Type | Macro                            | Default                       | Description  |
|------|----------------------------------|-------------------------------|--|
| N    | <code>GUI_DEFAULT_BKCOLOR</code> | <code>GUI_BLACK</code>        | Define the default background color.   |
| N    | <code>GUI_DEFAULT_COLOR</code>   | <code>GUI_WHITE</code>        | Define the default foreground color.   |
| S    | <code>GUI_DEFAULT_FONT</code>    | <code>&amp;GUI_Font6x8</code> | Defines which font is used per default after <code>GUI_Init()</code> . If you do not use the default font, it makes sense to change to a different default, as |

| Type | Macro | Default | Description  |
|------|-------|---------|--|
|      |       |         | the default font is referenced by the code and will therefore always be linked.<br>Please also refer to <code>GUI_SetDefaultFont()</code> which can be used for runtime configuration of the default font. |

The default colors and fonts of the widgets which are part of the optional Window Manager can also be configured. For details, refer to the chapter *Widgets (window objects)* on page 982.

### 3.5.1.3 Advanced GUI configuration options

The following table shows the available configuration macros:

| Type | Macro               | Default                      | Description   |
|------|---------------------|------------------------------|---|
| S    | GUI_DEBUG_LEVEL     | 1 (target)<br>4 (simulation) | Defines the debug level, which determines how many checks (assertions) are performed by emWin and if debug errors, warnings and messages are output. Higher debug levels generate bigger code.          |
| N    | GUI_MAXTASK         | 4                            | Define the maximum number of tasks from which emWin is called to access the display when multitasking support is enabled (see the chapter <i>Execution Model: Single Task / Multitask</i> on page 2876. |
| F    | GUI_MEMCPY          | memcpy                       | This macro allows replacement of the memcpy function.   |
| F    | GUI_MEMSET          | memset                       | This macro allows replacement of the memset function  |
| N    | GUI_NUM_LAYERS      | 1                            | Defines the maximum of available layers/displays.   |
| F    | GUI_POST_INIT       | -                            | Defines a function to be called at the end of <code>GUI_Init()</code> .   |
| B    | GUI_TRIAL_VERSION   | 0                            | Marks the compiler output as evaluation version.  |
| B    | GUI_WINSUPPORT      | 0                            | Enables optional Window Manager support.  |
| N    | GUI_PID_BUFFER_SIZE | 5                            | Maximum number of PID events managed by the input buffer.   |
| N    | GUI_KEY_BUFFER_SIZE | 10                           | Maximum number of key events managed by the input buffer.   |

#### 3.5.1.3.1 GUI\_MEMCPY (obsolete)

##### Note

Please refer to `GUI_SetpfMemcpy` on page 123.

This macro allows replacement of the memcpy function of the GUI. On a lot of systems, memcpy takes up a considerable amount of time because it is not optimized by the compiler manufacturer. emWin contains an alternative memcpy routine, which has been optimized for 32 bit CPUs. On a lot of systems this routine should generate faster code than the default memcpy routine. However, this is still a generic C routine, which in a lot of systems can be replaced by faster code, typically using either a different C routine, which is better optimized for the particular CPU or by writing a routine in Assembly language.

To use the optimized emWin routine add the following define to the file `GUIConf.h`:

```
#define GUI_MEMCPY GUI__memcpy
```

### 3.5.1.3.2 GUI\_MEMSET (obsolete)

#### Note

Please refer to *GUI\_SetpfMemset* on page 124.

This macro allows replacement of the memset function of the GUI. On a lot of systems, memset takes up a considerable amount of time because it is not optimized by the compiler manufacturer. We have tried to address this by using our own memset() Routine *GUI\_\_memset*. However, this is still a generic C routine, which in a lot of systems can be replaced by faster code, typically using either a different C routine, which is better optimized for the particular CPU, by writing a routine in Assembly language or using the DMA.

If you want to use your own memset replacement routine, add the define to the *GUIConf.h* file.

### 3.5.1.3.3 GUI\_POST\_INIT

It could make sense to have a function which is called after the GUI has been completely initialized. To be able to have that the macro could be defined as follows:

#### Example

```
#define GUI_POST_INIT CustomFunction();
```

### 3.5.1.3.4 GUI\_TRIAL\_VERSION

This macro can be used to mark the compiler output as an evaluation build. It should be defined if the software is given to a third party for evaluation purpose (typically with evaluation boards).

Note that a special license is required to do this; the most common licenses do not permit redistribution of emWin in source or object code (relinkable) form. Contact [sales@segger.com](mailto:sales@segger.com) if you would like to do this.

If *GUI\_TRIAL\_VERSION* is defined, the following message is shown when calling *GUI\_Init()*:

```
This software
contains an eval-
build of emWin.

A license is
required to use
it in a product.

www.segger.com
```

This message is always shown in the upper left corner of the display and is normally visible for 1 second. The timing is implemented by a call of *GUI\_X\_Delay(1000)*. The functionality of emWin is in no way limited if this switch is active.

#### Example

```
#define GUI_TRIAL_VERSION 1
```

## 3.5.2 Customizing LCDConf.h

This file contains general configuration options required for compiling the display driver(s) which need not to be changed at run-time. The available configuration options depend on the used display driver. For details about the available configuration options, refer to the chapter *Display drivers* on page 2927. The detailed driver description shows the available configuration options for each display driver.

## 3.6 Hardware acceleration

If a CPU or an LCD-controller offers hardware acceleration features some or even most of them could be used by emWin for accelerating the process of drawing operations. To be able to achieve that, different mechanisms need to be used dependent on the kind of hardware acceleration which should be used.

The following table shows a rough classification of the features which could be accelerated:

| Group                                       | Purpose  |
|---|--|
| Color conversion                            | Some hardware like ChromART offers the possibility of converting colors from one format to a different format. For that many of the color conversion routines offers the possibility to set a hardware function for the process of color conversion. |
| Drawing of primitives                       | Hardware accelerated drawing of primitives (also anti-aliased) could be achieved by calling primitive specific setters for passing custom defined functions to be used for drawing.  |
| Filling, copy operations and bitmap drawing | Those operations could be accelerated by setting custom drawing functions using <code>LCD_SetDevFunc()</code> .  |
| Alpha blending                              | A custom function could be used to mix up the given foreground and background colors in accordance to the alpha values of the colors.  |
| Mixing colors                               | A custom function could be used to mix up the given foreground and background colors with the given intensity.   |
| Alpha text drawing                          | Drawing of anti-aliased text could be achieved by setting a custom function.   |
| Palette conversion                          | Conversion of bitmap palettes could be done by a custom function.  |
| Drawing bitmaps with-in memory devices      | Some internal memory device operations could be accelerated by setting a custom function.  |

### 3.6.1 Ready to use configurations

The following table shows some of the hardware accelerators which can be used with ready-to-use sample configurations that come with emWin. These sample configurations set up emWin to use most of the features of the hardware accelerators. They can be used on appropriate hardware with little or no modification:

| Hardware                          | Supported features   |
|-----------------------------------|--|
| Renesas D/AVE 2D hardware IP core | Clipping<br>Drawing of anti-aliased primitives<br>Drawing of bitmaps (8-, 16- and 32 bpp)<br>Filling operations<br>Rectangle filling with alpha blending<br>Drawing of anti-aliased text   |
| STM32 ChromART Accelerator        | Color conversion<br>Drawing of bitmaps (8-, 16- and 32bpp)<br>Filling operations<br>Rectangle filling with alpha blending (only supported by some devices, for example by STM32L4R9I)<br>Drawing of anti-aliased text<br>Rectangular copy operations |

Please note that the absence of an accelerator in the above table does not mean that it is not supported by emWin. It does only mean that we do not have ready to use configuration files for it.

## 3.6.2 Using D/AVE 2D hardware IP core

A useful feature of D/AVE 2D hardware IP core is the ability to support a clipping rectangle. Furthermore, it offers a dedicated hardware module for performing anti-aliased drawing operations for anti-aliased shapes. Performing these operations by software requires a lot of CPU time. emWin offers an interface to route these operations to the D/AVE 2D hardware. That makes it ideal for very fast drawing of complex screens with anti-aliased shapes. Also, it is able to fill rectangular areas with a semi-transparent color which can be used for e.g. dimming screen areas. Configuration files can be found under `Sample\LCDConf\GUIDRV_Lin\RX65N` and `Sample\LCDConf\GUIDRV_Lin\EK_RA6M3G`.

## 3.6.3 Using ChromART accelerator

Nearly all functions provided by the ChromART accelerator can be used with emWin. Once configured correctly, it speeds up many drawing operations drastically. The sample folder of emWin contains configuration files which use almost all features of ChromART accelerator which can be found under `Sample\LCDConf\GUIDRV_Lin\STM32xxx`. Please note that the samples are only available if the driver `GUIDRV_Lin` is licensed.

The ChromART accelerators on ST devices are not all identical, e.g. the STM32L4R9I is able to fill rectangular areas with semitransparent colors, but this function is not provided by ChromART on some other ST devices. To take these differences into account, a separate configuration can be found under `Sample\LCDConf\GUIDRV_Lin\STM32L4R9I`.

## 3.6.4 Available API functions

The following table shows the available routines:

| Routine   | Description  |
|---|--|
| Color conversion  |  |
| <a href="#">GUICC_M1555I_SetCustColorConv()</a><br><a href="#">GUICC_M565_SetCustColorConv()</a><br><a href="#">GUICC_M4444I_SetCustColorConv()</a><br><a href="#">GUICC_M888_SetCustColorConv()</a><br><a href="#">GUICC_M8888I_SetCustColorConv()</a> | Setting up custom color conversion routines for the according fixed palette modes.   |
| Filling, copy operations and bitmap drawing   |  |
| <a href="#">LCD_SetDevFunc()</a>  | The function sets additional and / or user defined functions of the display driver.  |
| Alpha blending  |  |
| <a href="#">GUI_AlphaEnableFillRectHW()</a>   | Enables filling a rectangle with a transparent color.  |
| <a href="#">GUI_SetFuncAlphaBlending()</a>  | Setting up a custom defined function for doing alpha blending operations.  |
| <a href="#">GUI_SetFuncDrawAlpha()</a>  | Sets two custom routines for drawing memory devices with alpha value into another memory device and for drawing a bitmap with alpha value. |
| Mixing colors   |  |
| <a href="#">GUI_SetFuncMixColors()</a>  | Setting up a custom defined function for blending a single background color value with the given color using the given intensity.          |
| <a href="#">GUI_SetFuncMixColorsBulk()</a>  | Setting up a custom defined function for bulk blending operations.   |
| Alpha text drawing  |  |



| Routine  | Description  |
|--|--|
| <code>GUI_AA_SetpfDrawCharAA4()</code>           | Sets up a custom defined function for drawing alpha blending characters with 4 bits per pixel.                 |
| Palette conversion                               |  |
| <code>GUI_SetFuncGetpPalConvTable()</code>       | Sets a function pointer to a custom function, which converts an array of colors into an array of index values. |
| Drawing bitmaps within memory devices            |  |
| <code>GUI_MEMDEV_SetDrawMemdev16bppFunc()</code> | Sets a custom function for the above described job.  |
| Drawing shapes                                   |  |
| <code>GUI_SetFuncFillCircle()</code>             | This function sets a function pointer which gets called to fill a circle.                                      |
| <code>GUI_SetFuncDrawCircle()</code>             | This function sets a function pointer which gets called to draw a circle.                                      |
| <code>GUI_SetFuncFillRoundedRect()</code>        | Sets a function pointer to fill a rounded rectangle by hardware.   |
| <code>GUI_SetFuncDrawRoundedRect()</code>        | Sets a function pointer to draw a rounded rectangle by hardware.   |
| <code>GUI_SetFuncDrawLine()</code>               | This function sets a function pointer which gets called to draw a line.  |
| Drawing anti-aliased shapes                      |  |
| <code>GUI_AA_SetFuncFillCircle()</code>          | This function sets a function pointer which gets called to fill an anti aliased circle.                        |
| <code>GUI_AA_SetFuncFillPolygon()</code>         | This function sets a function pointer which gets called to fill an anti aliased polygon.                       |
| <code>GUI_AA_SetFuncDrawCircle()</code>          | This function sets a function pointer which gets called to draw an anti aliased circle.                        |
| <code>GUI_AA_SetFuncDrawLine()</code>            | This function sets a function pointer which gets called to draw an anti aliased line.                          |
| <code>GUI_AA_SetFuncDrawPolyOutline()</code>     | This function sets a function pointer which gets called to draw an anti aliased polygon.                       |
| <code>GUI_AA_SetFuncDrawArc()</code>             | This function sets a function pointer which gets called to draw an anti aliased arc.                           |
| JPEG decoding                                    |  |
| <code>GUI_JPEG_SetpfDrawEx()</code>              | This function sets a function pointer to be used to decode and draw a JPEG file.                               |

## 3.6.5 Color conversion

As explained in detail in *Colors* on page 478, color conversion in emWin is required for converting a color value into an index value and vice versa. That is done by the routines pointed by the fixed palette mode structures. These structures have pointers for converting single items and also for bulk conversion of multiple items. The most important color conversions offers the possibility for setting custom defined routines for bulk conversion.

### 3.6.5.1 GUICC\_M1555I\_SetCustColorConv()

### 3.6.5.2 GUICC\_M565\_SetCustColorConv()

### 3.6.5.3 GUICC\_M4444I\_SetCustColorConv()

### 3.6.5.4 GUICC\_M888\_SetCustColorConv()

### 3.6.5.5 GUICC\_M8888I\_SetCustColorConv()

#### Description

These routines can be used to set custom routines for bulk color conversion for the according color conversion.

#### Prototype

```
void GUICC_XXX_SetCustColorConv(tLCDDEV_Color2IndexBulk * pfColor2IndexBulk,
                               tLCDDEV_Index2ColorBulk * pfIndex2ColorBulk);
```

#### Parameters

| Parameter                      | Description  |
|--------------------------------|--|
| <code>pfColor2IndexBulk</code> | Routine to be used for converting multiple colors into index values. |
| <code>pfIndex2ColorBulk</code> | Routine to be used for converting multiple index values into colors. |

#### Additional information

The definition of `tLCDDEV_Color2IndexBulk` is as follows:

```
typedef void tLCDDEV_Color2IndexBulk(
    LCD_COLOR * pColor,
    void * pIndex,
    U32 NumItems,
    U8 SizeOfIndex
);
```

The definition of `tLCDDEV_Index2ColorBulk` is as follows:

```
typedef void tLCDDEV_Index2ColorBulk(
    void * pIndex,
    LCD_COLOR * pColor,
    U32 NumItems,
    U8 SizeOfIndex
);
```

### 3.6.6 Filling, copy operations and bitmap drawing

As already explained before that can be achieved by the function *LCD\_SetDevFunc* on page 3129.

## 3.6.7 Alpha blending

### 3.6.7.1 GUI\_AlphaEnableFillRectHW()

#### Description

Enables filling a rectangle with a transparent color.

#### Prototype

```
void GUI_AlphaEnableFillRectHW(int OnOff);
```

#### Parameters

| Parameter | Description   |
|-----------|---|
| OnOff     | Turns filling a rectangle with a transparent color on or off. |

#### Additional information

This function requires a function for filling a rectangle by the hardware. Please refer to `LCD_SetDevFunc()`.

### 3.6.7.2 GUI\_SetFuncAlphaBlending()

#### Description

Sets a custom defined routine for alpha blending operations. That routine is called by emWin if multiple foreground colors should be mixed up with the background.

#### Prototype

```
void ( * GUI_SetFuncAlphaBlending(void ( * pFunc)
                                (LCD_COLOR          * pColorFG,
                                 LCD_COLOR          * pColorBG,
                                 LCD_COLOR          * pColorDst,
                                 U32 NumItems))) (LCD_COLOR * pColorFG,
                                                LCD_COLOR * pColorBG,
                                                LCD_COLOR * pColorDst,
                                                U32      NumItems);
```

#### Parameters

| Parameter             | Description                         |
|-----------------------|-------------------------------------|
| <a href="#">pFunc</a> | Pointer to the function to be used. |

#### Return value

Pointer to the previous used function.

#### Parameters of pFunc()

| Data type   | Parameter                  | Description                            |
|-------------|----------------------------|--|
| LCD_COLOR * | <a href="#">pColorFG</a>   | Pointer to the foreground color array. |
| LCD_COLOR * | <a href="#">pColorBG</a>   | Pointer to the background color array. |
| LCD_COLOR * | <a href="#">pColorDest</a> | Pointer to a buffer for the result.    |
| U32         | <a href="#">NumItems</a>   | Number of colors to be mixed up.       |

### 3.6.7.3 GUI\_SetFuncDrawAlpha()

#### Description

Sets two custom routines for drawing memory devices with alpha value into another memory device and for drawing a bitmap with alpha value.

#### Prototype

```
int GUI_SetFuncDrawAlpha(GUI_DRAWMEMDEV_FUNC * pfDrawAlphaMemdevFunc,
                        GUI_DRAWBITMAP_FUNC * pfDrawAlphaBitmapFunc);
```

#### Parameters

| Parameter                             | Description  |
|---------------------------------------|--|
| <a href="#">pfDrawAlphaMemdevFunc</a> | Pointer to a function for drawing bitmaps in memory devices. |
| <a href="#">pfDrawAlphaBitmapFunc</a> | Pointer to a function for drawing bitmaps in frame buffer.   |

#### Additional information

The prototype of the function used for memory devices is:

```
void GUI_DRAWMEMDEV_FUNC (
    void * pDst,
    const void * pSrc,
    int xSize,
    int ySize,
    int BytesPerLineDst,
    int BytesPerLineSrc);
```

The prototype of the function used for bitmaps is:

```
void GUI_DRAWBITMAP32_FUNC (int LayerIndex,
    int x,
    int y,
    U32 const * p,
    int xSize,
    int ySize,
    int BytesPerLine);
```

## 3.6.8 Mixing colors

Mixing up colors here means mixing up the given background with the given foreground using the given intensity.

### 3.6.8.1 GUI\_SetFuncMixColors()

#### Description

Sets a custom defined routine for mixing up single colors.

#### Prototype

```
LCD_COLOR ( * GUI_SetFuncMixColors(LCD_COLOR ( * pFunc)
                                     (LCD_COLOR          Color,
                                      LCD_COLOR          BkColor,
                                      U8 Intens))) (LCD_COLOR Color,
                                                  LCD_COLOR BkColor,
                                                  U8          Intens);
```

#### Parameters

| Parameter          | Description                         |
|--------------------|-------------------------------------|
| <code>pFunc</code> | Pointer to the function to be used. |

#### Parameters of pFunc()

| Data type | Parameter            | Description                                      |
|-----------|----------------------|--|
| LCD_COLOR | <code>Color</code>   | Color to be blended with the given intensity.    |
| LCD_COLOR | <code>BkColor</code> | Color of background.                             |
| U8        | <code>Intens</code>  | Intensity to be used for the blending operation. |

### 3.6.8.2 GUI\_SetFuncMixColorsBulk()

#### Description

Sets up a custom defined function for bulk mixing operations. That is mainly used for fading memory devices. It mixes up the given background area with the given foreground area using the desired intensity.

#### Prototype

```
void ( * GUI_SetFuncMixColorsBulk(void ( * pFunc)(U32          * pFG,
U32          * pBG,
U32          * pDst,
unsigned     OffFG,
unsigned     OffBG,
unsigned     OffDest,
unsigned     xSize,
unsigned     ySize,
U8 Intens))) (U32 * pFG,
U32 * pBG,
U32 * pDst,
unsigned OffFG,
unsigned OffBG,
unsigned OffDest,
unsigned xSize,
unsigned ySize,
U8 Intens);
```

#### Parameters

| Parameter          | Description                         |
|--------------------|-------------------------------------|
| <code>pFunc</code> | Pointer to the function to be used. |

#### Parameters of pFunc()

| Data type | Parameter            | Description  |
|-----------|----------------------|--|
| U32 *     | <code>pFG</code>     | Pointer to the foreground color array.   |
| U32 *     | <code>pBG</code>     | Pointer to the background color array.   |
| U32 *     | <code>pDst</code>    | Pointer to the destination buffer for the result.  |
| unsigned  | <code>OffFG</code>   | (currently not used)   |
| unsigned  | <code>OffBG</code>   | Pointer to the destination buffer for the result.  |
| unsigned  | <code>OffDest</code> | Additional offset in pixels ( <code>xSizeBG - xSizeFG</code> ) to be added for incrementing the background pointer at the end of a line. |
| unsigned  | <code>xSize</code>   | X-size of area to be converted.  |
| unsigned  | <code>ySize</code>   | Y-size of area to be converted.  |
| U8        | <code>Intens</code>  | Intensity to be used when blending the foreground over the background.   |

#### Return value

Pointer to the previous used function.



## 3.6.9 Alpha text drawing

If transparent mode is active, no memory device is selected and no clipping is required a custom function could be used for drawing anti-aliased characters. In all other cases automatically the default function is used by emWin. Alpha text drawing means that the given character image consists of intensity values which need to be used to mix up the current background with the current foreground color.

### 3.6.9.1 GUI\_AA\_SetpfDrawCharAA4()

#### Description

Sets up a custom defined function for drawing alpha blending characters with 4 bits per pixel. The intensities to be used are stored in a byte array passed to the function. Each pixel is stored in one nibble. The leftmost pixel is stored in the uppermost nibble.

#### Prototype

```
void GUI_AA_SetpfDrawCharAA4
    (int ( *pfDrawChar)
(int LayerIndex , int x , int y , U8 const * p , int xSize , int ySize , int BytesPerLine ));
```

#### Parameters

| Parameter               | Description                         |
|-------------------------|-------------------------------------|
| <code>pfDrawChar</code> | Pointer to the function to be used. |

#### Parameters of pfDrawChar()

| Data type  | Parameter                 | Description  |
|------------|---------------------------|--|
| int        | <code>LayerIndex</code>   | Destination layer of drawing operation.                                  |
| int        | <code>xPos</code>         | X-Position in screen coordinates to be used.                             |
| int        | <code>yPos</code>         | Y-Position in screen coordinates to be used.                             |
| const U8 * | <code>p</code>            | Pointer to an array of bytes containing the intensity values to be used. |
| int        | <code>xSize</code>        | X-size of character to be drawn.   |
| int        | <code>ySize</code>        | Y-size of character to be drawn.   |
| int        | <code>BytesPerLine</code> | Bytes per line of the intensity array.                                   |

## 3.6.10 Palette conversion

Palettes need to be converted when drawing device independent bitmaps with a color depth of not more than 8 bits per pixel. The conversion routine converts the colors of the bitmap palette into index values to be used for drawing into the frame buffer. For that conversion process, normally done by emWin, a custom function can be set.

### 3.6.10.1 GUI\_SetFuncGetpPalConvTable()

#### Description

Sets a function pointer to a custom function, which converts an array of colors into an array of index values. It should return a pointer to the first entry of the index table.

#### Prototype

```
void GUI_SetFuncGetpPalConvTable
    (LCD_PIXELINDEX * ( *pFunc)
 (const LCD_LOGPALETTE * pLogPal , const GUI_BITMAP * pBitmap , int LayerIndex ));
```

#### Parameters

| Parameter          | Description                         |
|--------------------|-------------------------------------|
| <code>pFunc</code> | Pointer to the function to be used. |

#### Parameters of pfFunc()

| Data type                           | Parameter               | Description                                     |
|-------------------------------------|-------------------------|---|
| <code>const LCD_LOGPALETTE *</code> | <code>pLogPal</code>    | Pointer to the array of colors to be converted. |
| <code>const GUI_BITMAP *</code>     | <code>pBitmap</code>    | Pointer to the bitmap to be drawn.              |
| <code>int</code>                    | <code>LayerIndex</code> | Layer index of drawing operation.               |

#### Elements of structure LCD\_LOGPALETTE

| Data type                      | Element                  | Description  |
|--------------------------------|--------------------------|--|
| <code>int</code>               | <code>NumEntries</code>  | Number of color values located in the palette.   |
| <code>char</code>              | <code>HasTrans</code>    | 0 - No transparency should be used.<br>1 - Pixels with index 0 are treated as transparent. |
| <code>const LCD_COLOR *</code> | <code>pPalEntries</code> | Pointer to the array of color values.  |

#### Return value

A pointer to the array of index values of type `LCD_PIXELINDEX`.

#### Additional information

The process of drawing a bitmap within emWin and the mechanism of color conversion should be well known when using that function.

## 3.6.11 Drawing bitmaps within memory devices

A custom function for drawing bitmaps with a color depth of 16bpp into memory devices with a color depth of 16bpp can be used. The task of that function is copying the data of the bitmap to be drawn into the destination memory device.

### 3.6.11.1 GUI\_MEMDEV\_SetDrawMemdev16bppFunc()

#### Description

Sets a custom function for the above described job.

#### Prototype

```
void GUI_MEMDEV_SetDrawMemdev16bppFunc
    (GUI_DRAWMEMDEV_16BPP_FUNC * pfDrawMemdev16bppFunc);
```

#### Parameters

| Parameter                             | Description                         |
|---------------------------------------|-------------------------------------|
| <a href="#">pfDrawMemdev16bppFunc</a> | Pointer to the function to be used. |

#### Additional information

The definition of GUI\_DRAWMEMDEV\_16BPP\_FUNC is as follows:

```
typedef void GUI_DRAWMEMDEV_16BPP_FUNC (
void * pDst,
const void * pSrc,
int xSize,
int ySize,
int BytesPerLineDst,
int BytesPerLineSrc
);
```

#### Parameters of GUI\_DRAWMEMDEV\_16BPP\_FUNC

| Data type    | Parameter                       | Description   |
|--------------|---------------------------------|---|
| void *       | <a href="#">pDst</a>            | Destination pointer for upper left pixel to be drawn. |
| const void * | <a href="#">pSrc</a>            | Source pointer for upper left pixel to be drawn.      |
| int          | <a href="#">xSize</a>           | X-size in pixels of area to be drawn.                 |
| int          | <a href="#">ySize</a>           | Y-size in pixels of area to be drawn.                 |
| int          | <a href="#">BytesPerLineDst</a> | Stride value in bytes of destination area.            |
| int          | <a href="#">BytesPerLineSrc</a> | Stride value in bytes of source bitmap.               |

## 3.6.12 Drawing shapes

### 3.6.12.1 GUI\_SetFuncFillCircle()

#### Description

This function sets a function pointer which gets called to fill a circle.

#### Prototype

```
void GUI_SetFuncFillCircle(int (*pfFillCircle)(int x0 , int y0 , int r));
```

#### Parameters

| Parameter                 | Description  |
|---------------------------|--|
| <code>pfFillCircle</code> | Function pointer to a function for filling a circle. |

#### Parameters of pfFillCircle()

| Data type | Parameter       | Description                             |
|-----------|-----------------|---|
| int       | <code>x0</code> | x position of the center of the circle. |
| int       | <code>y0</code> | y position of the center of the circle. |
| int       | <code>r</code>  | Radius of the circle.                   |

### 3.6.12.2 GUI\_SetFuncDrawCircle()

#### Description

This function sets a function pointer which gets called to draw a circle.

#### Prototype

```
void GUI_SetFuncDrawCircle(int (*pfDrawCircle)(int x0 , int y0 , int r ));
```

#### Parameters

| Parameter                 | Description  |
|---------------------------|--|
| <code>pfDrawCircle</code> | Function pointer to a function for drawing a circle. |

#### Parameters of pfDrawCircle()

| Data type | Parameter       | Description                             |
|-----------|-----------------|---|
| int       | <code>x0</code> | x position of the center of the circle. |
| int       | <code>y0</code> | y position of the center of the circle. |
| int       | <code>r</code>  | Radius of the circle.                   |

### 3.6.12.3 GUI\_SetFuncFillRoundedRect()

#### Description

Sets a function pointer to fill a rounded rectangle by hardware.

#### Prototype

```
void GUI_SetFuncFillRoundedRect
    (int ( *pfFillRoundedRect)(int x0 , int y0 , int x1 , int y1 , int r ));
```

#### Parameters

| Parameter                      | Description                           |
|--------------------------------|---------------------------------------|
| <code>pfFillRoundedRect</code> | Pointer to the function to be called. |

#### Parameters of pfFillRoundedRect()

| Data type | Parameter       | Description                  |
|-----------|-----------------|------------------------------|
| int       | <code>x0</code> | Upper left X-position.       |
| int       | <code>y0</code> | Upper left Y-position.       |
| int       | <code>x1</code> | Lower right X-position.      |
| int       | <code>y1</code> | Lower right Y-position.      |
| int       | <code>r</code>  | Radius in pixels to be used. |

### 3.6.12.4 GUI\_SetFuncDrawRoundedRect()

#### Description

Sets a function pointer to draw a rounded rectangle by hardware.

#### Prototype

```
void GUI_SetFuncDrawRoundedRect
    (int (*pfDrawRoundedRect)(int x0 , int y0 , int x1 , int y1 , int r ));
```

#### Parameters

| Parameter                         | Description                           |
|-----------------------------------|---------------------------------------|
| <a href="#">pfDrawRoundedRect</a> | Pointer to the function to be called. |

#### Parameters of pfDrawRoundedRect()

| Data type | Parameter          | Description                  |
|-----------|--------------------|------------------------------|
| int       | <a href="#">x0</a> | Upper left X-position.       |
| int       | <a href="#">y0</a> | Upper left Y-position.       |
| int       | <a href="#">x1</a> | Lower right X-position.      |
| int       | <a href="#">y1</a> | Lower right Y-position.      |
| int       | <a href="#">r</a>  | Radius in pixels to be used. |

### 3.6.12.5 GUI\_SetFuncDrawLine()

#### Description

This function sets a function pointer which gets called to draw a line.

#### Prototype

```
void GUI_SetFuncDrawLine(int (*pfDrawLine)(int x0 , int y0 , int x1 , int y1 ));
```

#### Parameters

| Parameter               | Description  |
|-------------------------|--|
| <code>pfDrawLine</code> | Function pointer to a function for drawing a line. |

#### Parameters of pfDrawLine()

| Data type | Parameter | Description                   |
|-----------|-----------|-------------------------------|
| int       | x0        | Start x position of the line. |
| int       | y0        | Start y position of the line. |
| int       | x1        | End x position of the line.   |
| int       | y1        | End y position of the line.   |



## 3.6.13 Drawing anti-aliased shapes

### 3.6.13.1 GUI\_AA\_SetFuncFillCircle()

#### Description

This function sets a function pointer which gets called to fill an anti aliased circle.

#### Prototype

```
void GUI_AA_SetFuncFillCircle(int (*pfFillCircle)(int x0 , int y0 , int r ));
```

#### Parameters

| Parameter                 | Description  |
|---------------------------|--|
| <code>pfFillCircle</code> | Function pointer to a function for filling a circle. |

#### Parameters of pfFillCircle()

| Data type | Parameter       | Description                             |
|-----------|-----------------|---|
| int       | <code>x0</code> | x position of the center of the circle. |
| int       | <code>y0</code> | y position of the center of the circle. |
| int       | <code>r</code>  | Radius of the circle.                   |

### 3.6.13.2 GUI\_AA\_SetFuncFillPolygon()

#### Description

This function sets a function pointer which gets called to fill an anti aliased polygon.

#### Prototype

```
void GUI_AA_SetFuncFillPolygon
    (int ( *pfFillPolygon)
    (const GUI_POINT * pPoints , int NumPoints , int x0 , int y0 ));
```

#### Parameters

| Parameter                  | Description   |
|----------------------------|---|
| <code>pfFillPolygon</code> | Function pointer to a function for filling a polygon. |

#### Parameters of pfFillPolygon()

| Data type                | Parameter              | Description                                  |
|--------------------------|------------------------|--|
| <code>GUI_POINT *</code> | <code>pPoints</code>   | Pointer to a list of points.                 |
| <code>int</code>         | <code>NumPoints</code> | Number of elements of <code>pPoints</code> . |
| <code>int</code>         | <code>x0</code>        | x position of the start of the polygon.      |
| <code>int</code>         | <code>y0</code>        | y position of the start of the polygon.      |

### 3.6.13.3 GUI\_AA\_SetFuncDrawCircle()

#### Description

This function sets a function pointer which gets called to draw an anti aliased circle.

#### Prototype

```
void GUI_AA_SetFuncDrawCircle(int (*pfDrawCircle)(int x0 , int y0 , int r ));
```

#### Parameters

| Parameter                 | Description  |
|---------------------------|--|
| <code>pfDrawCircle</code> | Function pointer to a function for drawing a circle. |

#### Parameters of pfDrawCircle()

| Data type | Parameter       | Description                             |
|-----------|-----------------|---|
| int       | <code>x0</code> | x position of the center of the circle. |
| int       | <code>y0</code> | y position of the center of the circle. |
| int       | <code>r</code>  | Radius of the circle.                   |

### 3.6.13.4 GUI\_AA\_SetFuncDrawLine()

#### Description

This function sets a function pointer which gets called to draw an anti aliased line.

#### Prototype

```
void GUI_AA_SetFuncDrawLine
      (int ( *pfDrawLine)(int x0 , int y0 , int x1 , int y1 ));
```

#### Parameters

| Parameter               | Description  |
|-------------------------|--|
| <code>pfDrawLine</code> | Function pointer to a function for drawing a line. |

#### Parameters of pfDrawLine()

| Data type | Parameter | Description                   |
|-----------|-----------|-------------------------------|
| int       | x0        | Start x position of the line. |
| int       | y0        | Start y position of the line. |
| int       | x1        | End x position of the line.   |
| int       | y1        | End y position of the line.   |

### 3.6.13.5 GUI\_AA\_SetFuncDrawPolyOutline()

#### Description

This function sets a function pointer which gets called to draw an anti aliased polygon.

#### Prototype

```
void GUI_AA_SetFuncDrawPolyOutline
    (int ( *pfDrawPolyOutline)
    (const GUI_POINT * pSrc , int NumPoints , int Thickness , int x , int y ));
```

#### Parameters

| Parameter                      | Description   |
|--------------------------------|---|
| <code>pfDrawPolyOutline</code> | Function pointer to a function for drawing a polygon. |

#### Parameters of pfDrawPolyOutline()

| Data type                | Parameter              | Description                                  |
|--------------------------|------------------------|--|
| <code>GUI_POINT *</code> | <code>pPoints</code>   | Pointer to a list of points.                 |
| <code>int</code>         | <code>NumPoints</code> | Number of elements of <code>pPoints</code> . |
| <code>int</code>         | <code>Thickness</code> | The thickness of the poly outline.           |
| <code>int</code>         | <code>x0</code>        | x position of the start of the polygon.      |
| <code>int</code>         | <code>y0</code>        | y position of the start of the polygon.      |

### 3.6.13.6 GUI\_AA\_SetFuncDrawArc()

#### Description

This function sets a function pointer which gets called to draw an anti aliased arc.

#### Prototype

```
void GUI_AA_SetFuncDrawArc
    (int (*pfDrawArc)(int x0 , int y0 , int rx , int ry , I32 a0 , I32 a1 ));
```

#### Parameters

| Parameter              | Description  |
|------------------------|--|
| <code>pfDrawArc</code> | Function pointer to a function for drawing an arc. |

#### Parameters of pfDrawArc()

| Data type | Parameter       | Description                   |
|-----------|-----------------|-------------------------------|
| int       | <code>x0</code> | Center x position of the arc. |
| int       | <code>y0</code> | Center y position of the arc. |
| int       | <code>rx</code> | Radius in x direction.        |
| int       | <code>ry</code> | Radius in y direction.        |
| int       | <code>a0</code> | Start of the arc in degrees.  |
| int       | <code>a1</code> | End of the arc in degrees.    |

## 3.6.14 JPEG decoding

If the used MCU is capable of decoding JPEG files, emWin offers an interface to reroute the decoding and drawing operations to hardware routines.

This offers a huge performance boost when displaying JPEG files compared to a software only solution. Especially if a movie file should be displayed (.emf or .avi) it makes sense to use the hardware decoder of a MCU.

The interface between emWin and the hardware decoder was developed on a STM32F769 MCU but can be configured to work on other MCUs which come with a hardware JPEG decoder.

### Using hardware JPEG decoding

Every emWin shipment comes with a sample configuration file which is located under `Sample\JPEGConf\STM32F769`. It requires embOS and the hardware abstraction layer provided by ST because it was made to be used on a STM32F769. Using the hardware decoding functionality is basically achieved by setting a function pointer. This function will manage the process of decoding and drawing. Every time one of the functions `GUI_JPEG_Draw()` or `GUI_JPEG_DrawEx()` are used the set function pointer gets called.

If the function gets called, it is necessary to call the `GetData` function to receive as many bytes as required to start the JPEG decoding process. After receiving the data they get passed to the hardware routines and the decoding process starts. If required the `GetData` function has to be called multiple times until the decoding process has been finished.

After the process of hardware decoding the data needs to be converted from YCbCr format into RGB data. Unfortunately the STM32F769 offers no function to do that conversion per hardware. The `JPEGConf.c` mentioned before is an example on how to do this.

Once the data is completely converted into RGB data it is shown on the display (depending on the currently selected device).

### 3.6.14.1 GUI\_JPEG\_SetpfDrawEx()

#### Description

This function sets a function pointer to be used to decode and draw a JPEG file.

#### Prototype

```
void GUI_JPEG_SetpfDrawEx
    (int (*pfDrawEx)
    (GUI_GET_DATA_FUNC * pfGetData , void * p , int x0 , int y0 ));
```

#### Parameters

| Parameter             | Description                         |
|-----------------------|-------------------------------------|
| <code>pfDrawEx</code> | Pointer to the function to be used. |

#### Additional information

If set, the function pointer gets called if `GUI_JPEG_Draw()` or `GUI_JPEG_DrawEx()` gets called. The MOVIE module of emWin makes also use of this function. The function pointer is described below.

#### 3.6.14.1.1 pfDrawEx()

#### Description

This function pointer gets called every time a JPEG should be displayed. Within this function data needs to be received by the GetData function, the decoding process has to be performed as well as the drawing of the completely decoded JPEG on the display.

#### Prototype

```
int (* pfDrawEx)(GUI_GET_DATA_FUNC * pfGetData,
                void * p,
                int x0,
                int y0);
```

#### Parameters

| Parameter              | Description   |
|------------------------|---|
| <code>pfGetData</code> | Function pointer to a GetData function                |
| <code>p</code>         | Data pointer which is passed to the GetData function. |
| <code>x0</code>        | x position the JPEG file should be displayed.         |
| <code>y0</code>        | y position the JPEG file should be displayed.         |

#### Return value

0        on success.  
1        on error.

#### Additional information

An example of the GetData function can be found under *Getting data with the ...Ex() functions* on page 476. If this function returns 1 the default JPEG drawing routine of emWin gets called.



## 3.7 Framebuffer located in data cache area of CPU

If available it makes sense to enable a data cache on CPU side. That normally speeds up RAM access performance a lot. When using a direct addressable frame buffer (normally managed by `GUIDRV_Lin`) and if the frame buffer of the LCD-controller is located within a cached data memory area, it could happen, that the display shows some disturbance like shown on the screenshot to the right. Please note that this is not a malfunction of emWin. It is caused by the data cache of the CPU. The display driver (normally `GUIDRV_Lin`) writes into memory which is managed by the CPU's data cache. But unfortunately not all data is written directly into the RAM area of the frame buffer, but only into the data cache. In that case the LCD-controller does not have the correct data for generating the display signals. The following explains how to avoid that disturbance.

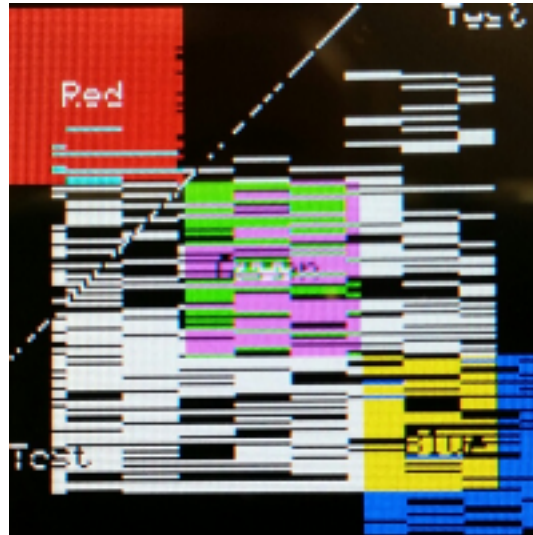

### 3.7.1 Requirements

To be able to use a data cache, it is required that either the cache could be configured to work in 'write-through' mode (please also refer to `GUIDRV_Lin` on page 2994) or multiple buffers should be used (please also refer to *Multiple Buffering* on page 712). If a 'write-through' mode is available, nothing else needs to be considered.

### 3.7.2 Using multiple buffers and a data cache

If the cache is not configurable, multiple buffering must be enabled and a cache clearance function should be set with `GUI_DCACHE_SetClearCacheHook()`.

#### 3.7.2.1 How it works

To be able to see always a screen without cache disturbance, it is required that emWin makes sure, the cache is cleared before the frame buffer becomes visible. That is done by calling the cache clearance function immediately before the back buffer becomes visible. In detail it is called immediately before the display driver callback function gets the command `LCD_X_SHOWBUFFER`.

#### When using the Window Manager

To make sure that all drawing operations are done automatically within the back buffer, the application should not draw anything outside the `WM_PAINT` event of the window manager.

#### 3.7.2.2 Animations and multiple buffering

The most recommended way to use animation functions is animating window content and invalidating the according windows within the animations. That makes sure, multi buffering is used automatically after enabled by `WM_MULTIBUF_Enable()`. If the window manager

is not available or when drawing with animations besides the Window Manager, a slice callback function using `GUI_MULTIBUF_Begin()` and `GUI_MULTIBUF_End()` should be used to make sure the DCache gets cleared. Please also refer to *Using a slice callback function* on page 617.

### 3.7.2.3 Memory device animation functions

#### Note

The following applies to functions listed in the following chapters:

- *Animation functions* on page 2690
- *Animation functions (Window Manager required)* on page 2694
- *Blending, Blurring and Dithering functions* on page 2699
- *Blending and Blurring functions (Window Manager required)* on page 2707

Normally those functions do not use multiple buffering. But in case of using a data cache, multiple buffering is required because all drawing operations need to be done within the back buffer before the cache is cleared and the back buffer becomes visible. For that case the function `GUI_MEMDEV_MULTIBUF_Enable()` should be used to enable that feature.

### 3.7.3 Available API functions

The following functions are available:

| Routine                                     | Description  |
|---|--|
| <code>GUI_DCACHE_Clear()</code>             | Calls the hook function set with <code>GUI_DCACHE_SetClearCacheHook()</code> . |
| <code>GUI_DCACHE_SetClearCacheHook()</code> | Sets up a function for clearing the cache of the given layer.                  |

### 3.7.3.1 GUI\_DCACHE\_Clear()

#### Description

Calls the hook function set with `GUI_DCACHE_SetClearCacheHook()`. Normally this function does not need to be called. It should be called automatically by emWin.

#### Prototype

```
void GUI_DCACHE_Clear(U32 LayerMask);
```

#### Parameters

| Parameter              | Description                       |
|------------------------|-----------------------------------|
| <code>LayerMask</code> | Bit mask of layers to be cleared. |

#### Additional information

Please refer to `GUI_DCACHE_SetClearCacheHook()`.

### 3.7.3.2 GUI\_DCACHE\_SetClearCacheHook()

#### Description

Sets up a function for clearing the cache of the given layer. That function is called immediately before a back buffer should become visible. That makes sure, no cache disturbance will be visible on the screen.

#### Prototype

```
void GUI_DCACHE_SetClearCacheHook(void ( *pFunc)(U32 LayerMask ));
```

#### Parameters

| Parameter          | Description                         |
|--------------------|-------------------------------------|
| <code>pFunc</code> | Pointer to the function to be used. |

#### Additional information

Parameter `LayerMask` passed to the hook function contains a bit mask of the layer(s) to be managed. The number of the bit represents the number of the layer. If for example the data cache of layer 2 should be cleared, bit 2 of the layer mask is set.

#### Example

The following shows a sample implementation of a clear cache function:

```
static void _ClearCacheHook(U32 LayerMask) {
    int i;
    for (i = 0; i < GUI_NUM_LAYERS; i++) {
        if (LayerMask & (1 << i)) {
            _CleanRange(_apVRAM[i], WIDTH * HEIGHT * NUM_BUFFERS * sizeof(U32));
        }
    }
}
```

## 3.8 Memory management

emWin comes with its own memory management system which makes it easy to calculate the total amount of memory required for emWin. Further, the user does not have to bother about allocating and freeing memory because emWin gets its own memory area.

### 3.8.1 Usage

With the function `GUI_ALLOC_AssignMemory()` the user spends emWin a block of memory which can reside in either internal or external memory. Once this block is allocated for emWin the user does not have to bother about memory management for emWin. emWin does only use the given memory area for allocating memory. This memory is used for Memory Devices, cache for indirect drivers, decompressing image data (e.g. JPEG, PNG) and many more operations which require a piece of memory. But, if using the `GUIDRV_Lin` driver, which requires a frame buffer, emWin does not allocate the memory for the frame buffer. This has to be done by the user.

The memory block gets managed by emWin and should not be accessed by the user directly. Otherwise it might come to unexpected behavior.

### 3.8.2 Block management

Memory in emWin get allocated in blocks. To manage these blocks emWin requires a few bytes of additional memory for each block. These bytes are located in a dedicated memory block. initially this block is quite small and can manage only a few memory blocks. Once emWin requires memory for the application (e.g. creating a window or a Memory Device) this block will grow up. This 'management'-memory gets reused if blocks are getting deleted and created again, but it will not get freed by emWin.

Sometimes it might look like a memory leak because the allocated 'management'-memory doesn't get freed but this is the normal behavior. Also, those bytes are not lost because they will get reused if possible.

### 3.8.3 Available API functions

The following functions allow control of memory usage at runtime. They can be used to e.g. prevent waste of memory.

| Routine                                  | Description   |
|--|---|
| <code>GUI_ALLOC_GetMaxUsedBytes()</code> | This function returns the number of the maximum number of used bytes.                 |
| <code>GUI_ALLOC_GetNumFreeBytes()</code> | This function returns the number of bytes which can be used for emWin functions.      |
| <code>GUI_ALLOC_GetMemInfo()</code>      | This function fills the given info structure with information about the memory usage. |
| <code>GUI_ALLOC_GetNumUsedBytes()</code> | This function returns the number of bytes which are already used by emWin functions.  |

### 3.8.3.1 GUI\_ALLOC\_GetMaxUsedBytes()

#### Description

This function returns the number of the maximum number of used bytes. This function is used to get the peak of used bytes.

#### Prototype

```
GUI_ALLOC_DATATYPE GUI_ALLOC_GetMaxUsedBytes(void);
```

#### Return value

Maximum number of used bytes.

### 3.8.3.2 GUI\_ALLOC\_GetNumFreeBytes()

#### Description

This function returns the number of bytes which can be used for emWin functions.

#### Prototype

```
GUI_ALLOC_DATATYPE GUI_ALLOC_GetNumFreeBytes(void);
```

#### Return value

Number of free bytes.

### 3.8.3.3 GUI\_ALLOC\_GetMemInfo()

#### Description

This function fills the given info structure with information about the memory usage.

#### Prototype

```
void GUI_ALLOC_GetMemInfo(GUI_ALLOC_INFO * pInfo);
```

#### Parameters

| Parameter          | Description                               |
|--------------------|---|
| <code>pInfo</code> | Pointer to to a GUI_ALLOC_INFO structure. |

#### Elements of structure GUI\_ALLOC\_INFO

| Data type | Element      | Description                                      |
|-----------|--------------|--|
| U32       | TotalBytes   | Total amount of bytes available.                 |
| U32       | FreeBytes    | Number of free bytes.                            |
| U32       | UsedBytes    | Number used bytes.                               |
| U32       | AllocSize    | Number of bytes available for memory management. |
| U32       | NumFixed     | Number of fixed bytes.                           |
| U32       | MaxUsedBytes | The peak of used bytes.                          |



### 3.8.3.4 GUI\_ALLOC\_GetNumUsedBytes()

#### Description

This function returns the number of bytes which are already used by emWin functions.

#### Prototype

```
GUI_ALLOC_DATATYPE GUI_ALLOC_GetNumUsedBytes(void);
```

#### Return value

Number of used bytes.

# Chapter 4

## Simulation

---

The PC simulation of emWin allows you to compile the same C source on your Windows PC using a native (typically Microsoft) compiler and create an executable for your own application. Doing so allows the following:

- Design of the user interface on your PC (no hardware required!).
- Debugging of the user interface program.
- Creation of demos of your application, which can be used to discuss the user interface.

The resulting executable can be sent easily via e-mail.



## 4.1 Using the simulation

The emWin simulation requires Microsoft Visual C++ (version 6.00 or higher) and the integrated development environment (IDE) which comes with it. You will see a simulation of your LCD on your PC screen, which has the same resolution in X and Y and can display the exact same colors as your LCD once it has been properly configured. The entire graphic library API and Window Manager API of the simulation are identical to those on your target system; all functions will behave in the very same way as on the target hardware since the simulation uses the same C source code as the target system. The difference lies only in the lower level of the software: the display driver. Instead of using the actual display driver, the PC simulation uses a simulation driver which writes into a bitmap. The bitmap is then displayed on your screen using a second thread of the simulation. This second thread is invisible to the application; it behaves just as if the LCD routines were writing directly to the display.

### 4.1.1 Rotating and mirroring the screen

emWin supports rotating and/or mirroring of the screen. Please note that these features do not affect the simulation screen.

### 4.1.2 Using the simulation with the trial version of emWin

The trial version of emWin contains a full library which allows you to evaluate all available features of emWin. It also includes the emWin viewer (used for debugging applications), as well as demo versions of the Font Converter and the Bitmap Converter. Keep in mind that, being a trial version, you will not be able to view the source code of emWin or the simulation, but you will still be able to become familiar with what emWin can do.

#### 4.1.2.1 Directory structure

The directory structure of the simulation in the trial version is shown below. The table below explains the contents of the folders:

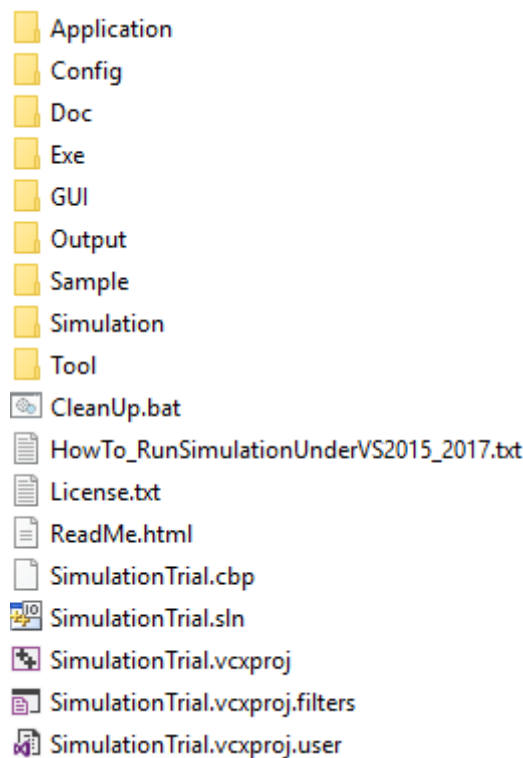

| Directory   | Content                     |
|-------------|-----------------------------|
| Application | Source of the demo program. |

| Directory  | Content   |
|------------|---|
| Config     | Configuration files used to build the library. Note that changes at the header files do not have any effect on the precompiled library! |
| Doc        | Document folder, contains emWin manual.   |
| Exe        | Ready-to-use demo program.  |
| GUI        | Library files and include files need to use the library.  |
| Sample     | Simulation examples.  |
| Simulation | Files needed for the simulation.  |
| Tool       | Contains all emWin tools, such as the emWin viewer, a demo version of the Bitmap and Font Converter and more.                           |

### 4.1.2.2 Visual C++ workspace

The root directory shown above includes the Microsoft Visual C++ solution (`SimulationTrial.sln`) and the rest of the project files. The workspace allows you to modify an application program and debug it before compiling it on your target system. Double-click the solution file to open the Microsoft Visual Studio IDE. The directory structure of the Visual C++ workspace will look like the one shown below.

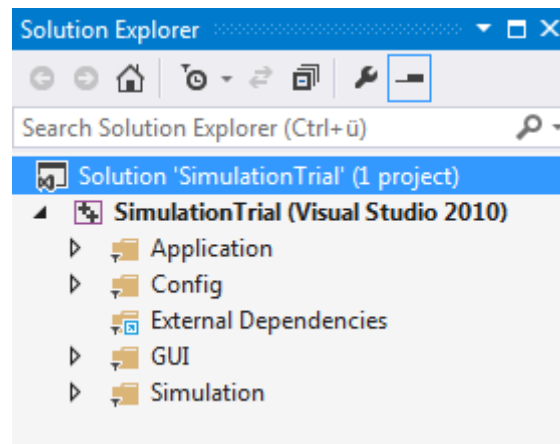

### 4.1.2.3 Compiling the demo program

The source files for the demo program are located in the `Application` directory as a ready-to-go simulation, meaning that you only need to rebuild and start it. Note that to rebuild the executable, you will need to have Microsoft Visual C++ (version 6.00 or later) installed.

- **Step 1:** Open the Visual C++ workspace by double-clicking on `SimulationTrial.sln`.
- **Step 2:** Rebuild the project by choosing **Build → Rebuild All** from the menu (or by pressing F7).
- **Step 3:** Start the simulation by choosing **Build → Start Debug → Go** from the menu (or by pressing F5). The demo project will begin to run and may be closed at any time by right-clicking on it and selecting **Exit**.

### 4.1.2.4 Compiling the samples

The `Sample` directory contains ready-to-go examples that demonstrate different features of emWin and provide examples of some of their typical uses. In order to build any of these executables, their C source must be 'activated' in the project. This is easily done with the following procedure:

- **Step 1:** Exclude the `Application` folder from the build process by right-clicking the `Application` folder of the workspace and selecting **Settings → General → Exclude from build**.

- **Step 2:** Open the Sample folder of the workspace by double-clicking on it. Include the example which should be used by right-clicking on it and deselecting **Settings** → **General** → **Exclude** from build.
- **Step 3:** If the example contains its own configuration files (`LCDConf.c` and/or `SIMConf.c`) the default configuration files located in the config folder need to be excluded from the build process.
- **Step 4:** Rebuild the example by choosing **Build** → **Rebuild All** from the menu (or by pressing F7).
- **Step 5:** Start the simulation by choosing **Build** → **Start Debug** → **Go** from the menu (or by pressing F5). The result of the example selected above is pictured below:



## 4.1.3 Using the simulation with the emWin source

### 4.1.3.1 Directory structure

The root directory of the simulation can be anywhere on your PC, for example `C:\Work\emWinSim`. The directory structure will appear as shown below. This structure is very similar to that which we recommend for your target application (see *Getting Started* on page 84 for more information).

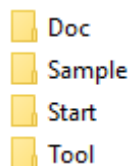

The following table shows the contents of the folders:

| Directory | Content   |
|-----------|---|
| Doc       | Contains the emWin documentation.                     |
| Sample    | Code examples, described later in this documentation. |
| Start     | All you need to create a new project with emWin.      |
| Tool      | Tools shipped with emWin.                             |

A new project can be started by making a copy of the Start-folder. It contains all required files for a new project. Subdirectories containing the emWin sources are in the `Start\GUI` folder and should contain the exact same files as the directories of the same names which

are used for your target (cross) compiler. The files of the GUI subdirectories should not be changed, as this would make updating to a newer version of emWin more difficult. The `Start\Config` directory contains configuration files which need to be modified in order to reflect your target hardware settings (mainly LCD-size and colors which can be displayed).

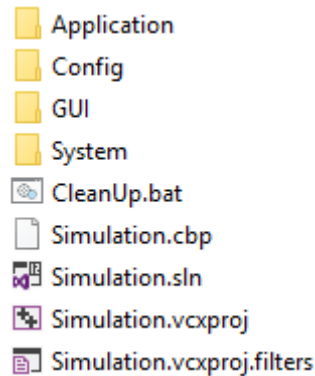

### 4.1.3.2 Visual C++ workspace

The root directory shown above includes the Microsoft Visual C++ workspace (`Simulation.dsw`) and project files (`Simulation.dsp`). The workspace allows you to modify an application program and debug it before compiling it on your target system. The directory structure of the Visual C++ workspace will appear similar to that shown to the right. Here, the `GUI` folder is open to display the emWin subdirectories. Note that your `GUI` directory may not look exactly like the one pictured, depending on which additional features of emWin you have. The folders `Core`, `Font` and `DisplayDriver` are part of the basic emWin package and will always appear in the workspace directory.

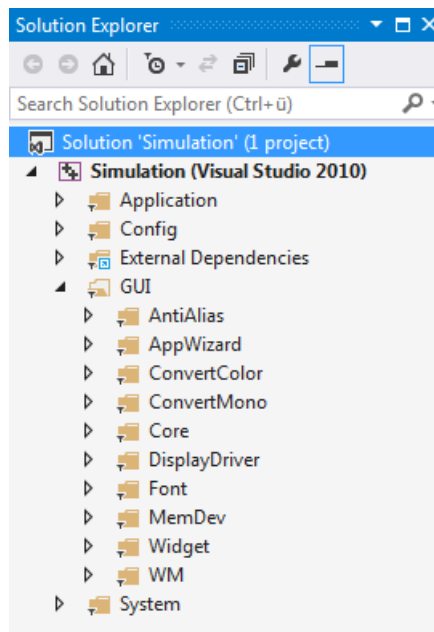

### 4.1.3.3 Compiling the application

The simulation contains one or more application C files (located in the `Application` directory), which can be modified or removed and additional files can be added to the project. You should then rebuild the program within the Visual C++ workspace in order to test/debug it. Once you have reached a point where you are satisfied with the result and want to use the program in your application, you should be able to compile these same files on your target system and get the same result on the target display. The general procedure for using the simulation would be as follows:

- **Step 1:** Open the Visual C++ workspace by double-clicking on `Simulation.dsw`.
- **Step 2:** Compile the project by choosing **Build → Rebuild All** from the menu (or by pressing F7).

- **Step 3:** Run the simulation by choosing **Build → Start Debug → Go** from the menu (or by pressing F5).
- **Step 4:** Replace the bitmap with your own logo or image.
- **Step 5:** Make further modifications to the application program as you wish, by editing the source code or adding/deleting files.
- **Step 6:** Compile and run the application program within Visual C++ to test the results. Continue to modify and debug as needed.
- **Step 7:** Compile and run the application program on your target system.

## 4.1.4 Advanced features of the simulation

Clicking the right mouse button shows a context menu with several advanced functions:

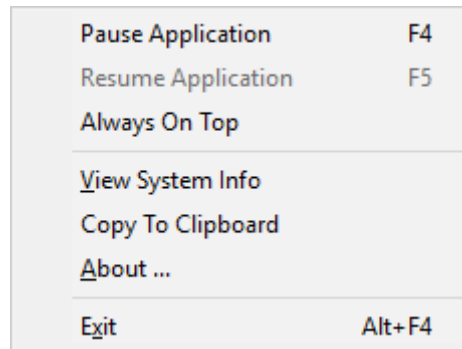

### 4.1.4.1 Pause and Resume

These menu items allow to pause and to resume the application currently running in the simulation. The same can be done by pressing **<F4>** or **<F5>**. Trying to pause an already paused application or trying to resume an already running application causes an error message.

### 4.1.4.2 View system info

This menu item opens a further window with information of the memory currently used by the application. The window continuously shows the current status of memory consumption by showing the free and used bytes and the free and used number of memory blocks.

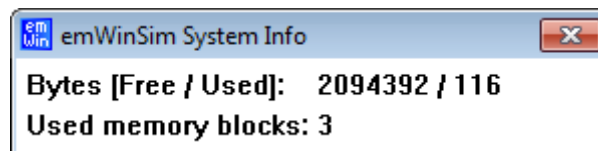

### 4.1.4.3 Copy to clipboard

This menu item copies the current contents of the display into the clipboard. This makes it easy to use it for documentation purpose with other applications.

## 4.2 Device simulation

The device simulation supports 3 views:

- Generated frame view
- Custom bitmap view
- Window view

The table below shows the different views:

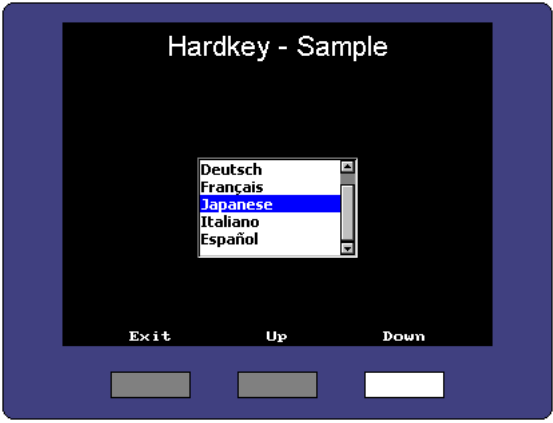
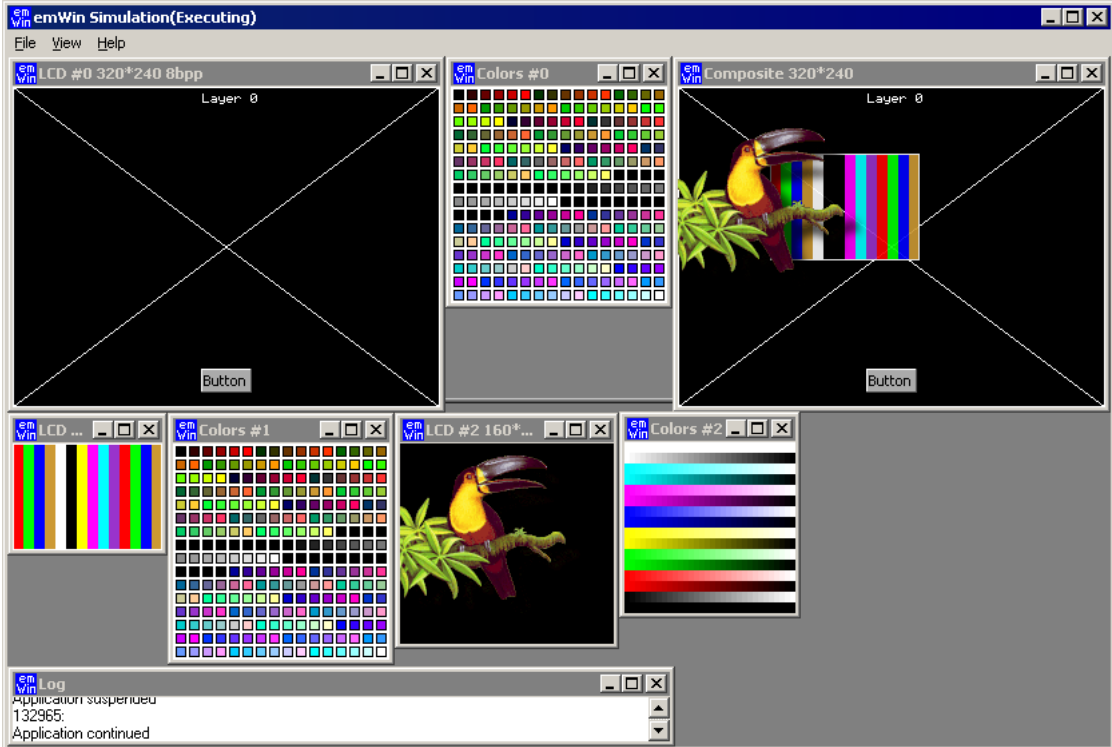
| Generated frame view   | Custom bitmap view   |
|--|--|
|     |  |
| Window view  |  |
|  |  |

The following will explain in detail how each option can be used.

### 4.2.1 Generated frame view

The simulation shows the display inside an automatically generated frame surrounding the display. The frame contains a small button which per default closes the application. This is the default behavior of the simulation for single layer systems. 'Single layer system' means that only the first layer is initialized.





## 4.2.2 Custom bitmap view

The simulation can show the simulated display in a bitmap of your choice, typically your target device. The bitmap can be used to simulate the behavior of the entire target device. In order to simulate the appearance of the device, bitmaps are required.

### Device bitmap

The first bitmap is usually a photo (top view) of the device, and needs to be named `Device.bmp`. It may be a separate file (in the same directory as the executable), or it may be included as a resource in the application. How to do this is explained later in this chapter. The file should provide an area for the simulated display of the same size in pixels as the physical display resolution.

If there are any hardkeys to be simulated the bitmap should also show all of them in unpressed state.

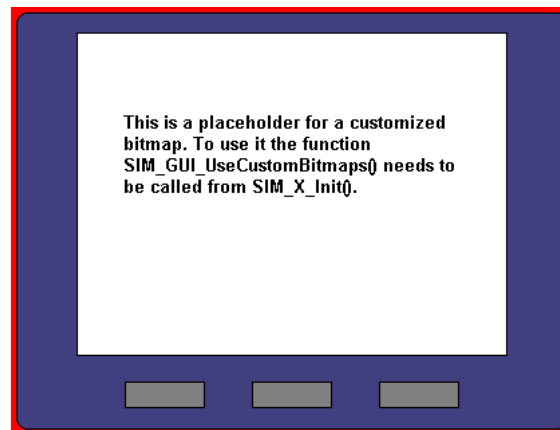

Transparent areas need to be colored with exact the same color as defined with the function `SIM_GUI_SetTransColor()`, typically red (`0xFF0000`). These areas do not have to be rectangular; they can have an arbitrary shape (up to a certain complexity which is limited by your operating system, but is normally sufficient). Red is the default color for transparent areas, mainly because it is not usually contained in most bitmaps. To use a bitmap with red, the default transparency color may be changed with the function `SIM_GUI_SetTransColor()`.

### Hardkey bitmap

The second bitmap file is required for defining the hardkeys and must be named `Device1.bmp`. It contains the buttons in pressed state. The non hardkey area has to be filled with the transparent color. This is only a short description. For more details about how to simulate hardkeys, see *Hardkey simulation* on page 200.

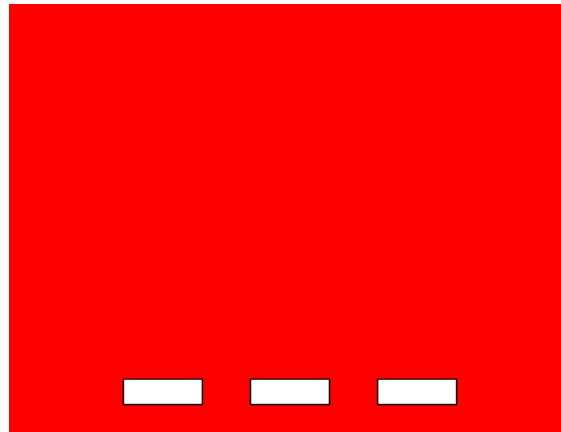

### Using separate files

When starting the simulation, it checks if the directory of the executable contains the bitmap files `Device.bmp` and `Device1.bmp`. If these files are available, they are used automatically and the resource bitmaps are ignored. Note that this is only valid with single layer systems.

### Adding the bitmap to the application resources

The resource file of the simulation can be found under `System\Simulation\Res\Simulation.rc`. It contains the following section:

```

////////////////////////////////////
//
// Customizable bitmaps
//
IDB_DEVICE          BITMAP  DISCARDABLE  "Device.bmp"
IDB_DEVICE1         BITMAP  DISCARDABLE  "Device1.bmp"

```

This section can be used to set custom device files. More information can be found in the Win32 documentation.

## 4.2.3 Window view

Default for simulating a multiple layer system is showing each layer in a separate window without using bitmaps or a generated frames.

## 4.3 Device simulation API

All of the device simulation API functions should be called in the setup phase. The calls should be done from within the routine `SIM_X_Config()`, which is located in the file `SIM-Conf.c` in the configuration folder. The example below calls `SIM_SetLCDPos()` in the setup:

```
#include "LCD_SIM.h"
void SIM_X_Config() {
    SIM_GUI_SetLCDPos(50, 20); // Define the position of the LCD in the bitmap
}
```

### Functions

| Routine                                     | Description  |
|---|--|
| <code>SIM_GUI_Delay()</code>                | Stops execution of simulation thread for the given period.   |
| <code>SIM_GUI_EnableModifierKey()</code>    | This function let modifier keys (ALT, CTRL) through to emWin.  |
| <code>SIM_GUI_ExecIdle()</code>             | Called by the simulation on idle time.   |
| <code>SIM_GUI_GetCompositeTouch()</code>    | Returns the layer index to be passed to emWin if the composite view is touched by the PID.                   |
| <code>SIM_GUI_GetTime()</code>              | Returns the period of time in ms elapsed since starting the simulation.                                      |
| <code>SIM_GUI_IsModifierKeyEnabled()</code> | This function indicates if modifier keys are turned on or not.   |
| <code>SIM_GUI_SaveBMP()</code>              | Saves a BMP file containing the current layer.   |
| <code>SIM_GUI_SaveBMPEx()</code>            | Saves a BMP file containing the given section of the current layer.  |
| <code>SIM_GUI_SaveCompositeBMP()</code>     | Saves a BMP file containing the current content of the composite view.                                       |
| <code>SIM_GUI_SetCallback()</code>          | Sets a callback function for receiving the handles of the simulation windows.                                |
| <code>SIM_GUI_SetCompositeColor()</code>    | Sets the background color of the composite window. (Only used with MultiLayer support)                       |
| <code>SIM_GUI_SetCompositeSize()</code>     | Enables composite window mode and sets the size of the composite window. (Only used with MultiLayer support) |
| <code>SIM_GUI_SetCompositeTouch()</code>    | Sets the layer index to be used for touch events on the composite view.                                      |
| <code>SIM_GUI_SetLCDColorBlack()</code>     | Set the colors to be used as black on color monochrome displays.   |
| <code>SIM_GUI_SetLCDColorWhite()</code>     | Set the colors to be used as white on color monochrome displays.   |
| <code>SIM_GUI_SetLCDPos()</code>            | Sets the position for the simulated LCD within the target device bitmap.                                     |
| <code>SIM_GUI_SetMag()</code>               | Sets magnification factors for X and/or Y axis.  |
| <code>SIM_GUI_SetTransColor()</code>        | Sets the color to be used for transparent areas of device or hardkey bitmaps.                                |
| <code>SIM_GUI_SetTransMode()</code>         | Sets the transparency mode for the given layer.  |
| <code>SIM_GUI_ShowDevice()</code>           | When using multiple layers, this function can be used to show the device bitmap.                             |

| Routine                                    | Description  |
|--|--|
| <a href="#">SIM_GUI_UseCustomBitmaps()</a> | Tells the simulation to use the custom bitmaps from the application resource file. |

### Data structures

| Structure                    | Description                                    |
|------------------------------|--|
| <a href="#">SIM_GUI_INFO</a> | Contains the window handles of the simulation. |

### Defines

| Group of defines                   | Description                              |
|------------------------------------|--|
| <a href="#">Transparency modes</a> | Available transparency modes for layers. |

## 4.3.1 Functions

### 4.3.1.1 SIM\_GUI\_Delay()

#### Description

Stops execution of simulation thread for the given period.

#### Prototype

```
void SIM_GUI_Delay(int ms);
```

#### Parameters

| Parameter | Description        |
|-----------|--------------------|
| ms        | Period to be used. |

### 4.3.1.2 SIM\_GUI\_EnableModifierKey()

#### Description

This function let modifier keys (ALT, CTRL) through to emWin.

#### Prototype

```
void SIM_GUI_EnableModifierKey(int OnOff);
```

#### Parameters

| Parameter | Description                   |
|-----------|-------------------------------|
| OnOff     | Turn modifier keys on or off. |

### 4.3.1.3 SIM\_GUI\_ExecIdle()

#### Description

Called by the simulation on idle time.

#### Prototype

```
void SIM_GUI_ExecIdle(void);
```

#### 4.3.1.4 SIM\_GUI\_GetCompositeTouch()

##### Description

Returns the layer index to be passed to emWin if the composite view is touched by the PID.

##### Prototype

```
int SIM_GUI_GetCompositeTouch(void);
```

##### Return value

Layer index passed to emWin if the composite view is touched.



### 4.3.1.5 SIM\_GUI\_GetTime()

#### Description

Returns the period of time in ms elapsed since starting the simulation.

#### Prototype

```
int SIM_GUI_GetTime(void);
```

#### Return value

Period of time in ms elapsed since starting the simulation.

### 4.3.1.6 SIM\_GUI\_IsModifierKeyEnabled()

#### Description

This function indicates if modifier keys are turned on or not.

#### Prototype

```
int SIM_GUI_IsModifierKeyEnabled(void);
```

#### Return value

- |   |                            |
|---|----------------------------|
| 0 | Modifier keys are disabled |
| 1 | Modifier keys are enabled  |

### 4.3.1.7 SIM\_GUI\_SaveBMP()

#### Description

Saves a BMP file containing the current layer.

#### Prototype

```
int SIM_GUI_SaveBMP(const char * sFileName);
```

#### Parameters

| Parameter              | Description          |
|------------------------|----------------------|
| <code>sFileName</code> | Filename to be used. |

#### Return value

0        on success  
1        on error.

### 4.3.1.8 SIM\_GUI\_SaveBMPEx()

#### Description

Saves a BMP file containing the given section of the current layer.

#### Prototype

```
int SIM_GUI_SaveBMPEx(const char * sFileName,
                      int x0,
                      int y0,
                      int xSize,
                      int ySize);
```

#### Parameters

| Parameter              | Description                                      |
|------------------------|--|
| <code>sFileName</code> | Filename to be used.                             |
| <code>x0</code>        | Left coordinate of the first pixels to be saved. |
| <code>y0</code>        | Top coordinate of the first pixels to be saved.  |
| <code>xSize</code>     | X-size in pixels of the section to be saved.     |
| <code>ySize</code>     | Y-size in pixels of the section to be saved.     |

#### Return value

0 on success  
1 on error.

### 4.3.1.9 SIM\_GUI\_SaveCompositeBMP()

#### Description

Saves a BMP file containing the current content of the composite view.

#### Prototype

```
int SIM_GUI_SaveCompositeBMP(const char * sFileName);
```

#### Parameters

| Parameter              | Description          |
|------------------------|----------------------|
| <code>sFileName</code> | Filename to be used. |

#### Return value

0        on success  
1        on error.

### 4.3.1.10 SIM\_GUI\_SetCallback()

#### Description

If it is required to simulate more than the display window or hardkeys, you can set a callback function to receive the window handles of the simulation. This opens up the possibility e.g. to add additional controls outside of the display window like leds or sliders. Please note that the emWin functions can not be used there.

#### Prototype

```
void SIM_GUI_SetCallback(int (*pfCallback)(SIM_GUI_INFO * pInfo));
```

#### Parameters

| Parameter                   | Description  |
|-----------------------------|--|
| <code>pfInfoCallback</code> | Pointer to the callback function. The function has to expect a pointer to a SIM_GUI_INFO structure as a parameter. |

#### Elements of structure SIM\_GUI\_INFO

| Data type | Element                     | Description                             |
|-----------|-----------------------------|---|
| HWND      | <code>hWndMain</code>       | Handle to the main window.              |
| HWND      | <code>ahWndLCD[16]</code>   | Array of handles to the display layers. |
| HWND      | <code>ahWndColor[16]</code> | Array of handles to the palette layers. |

### 4.3.1.11 SIM\_GUI\_SetCompositeColor()

#### Description

When simulating a multiple layer system each layer can be shown in its own window. However, the physical display has only one area. It shows the result of the blended layers. The simulation shows the result in the composite window which can have its own size independent of the layers. Each layer can have its own position and its own size within the composite window. This means that not necessarily the complete area is covered by the layers. For this case (and also for transparency effects) this function sets the default background color of the composite window.

#### Prototype

```
void SIM_GUI_SetCompositeColor(U32 Color);
```

#### Parameters

| Parameter | Description                  |
|-----------|------------------------------|
| Color     | Background color to be used. |

#### Additional information

This function does not have an effect when using SoftLayers.

### 4.3.1.12 SIM\_GUI\_SetCompositeSize()

#### Note

This function also enables the composite window mode. It is used in `SIM_X_Config()`.

#### Description

As described above under `SIM_GUI_SetCompositeColor()` the size of the composite window is independent of the size of the layers. This function is used to set the size of the composite window, as well as enable the composite window mode.

#### Prototype

```
void SIM_GUI_SetCompositeSize(int xSize,
                             int ySize);
```

#### Parameters

| Parameter          | Description                |
|--------------------|----------------------------|
| <code>xSize</code> | Horizontal size in pixels. |
| <code>ySize</code> | Vertical size in pixels.   |

#### Example

This example screenshot shows the enabled composite window mode. The two layers are shown on the right and on the left is the composite window, which shows the two layers merged.





### 4.3.1.13 SIM\_GUI\_SetCompositeTouch()

#### Description

Sets the layer index to be passed to emWin if the composite view is touched by the PID.

#### Prototype

```
void SIM_GUI_SetCompositeTouch(int LayerIndex);
```

#### Parameters

| Parameter               | Description  |
|-------------------------|--|
| <code>LayerIndex</code> | Layer index to be used for touch events on the composite view. |

### 4.3.1.14 SIM\_GUI\_SetLCDColorBlack()

### 4.3.1.15 SIM\_GUI\_SetLCDColorWhite()

#### Description

Set the colors to be used as black or white, respectively, on color monochrome displays.

#### Prototypes

```
int SIM_GUI_SetLCDColorBlack(int DisplayIndex,
                             int Color);
```

```
int SIM_GUI_SetLCDColorWhite(int DisplayIndex,
                              int Color);
```

#### Parameters

| Parameter    | Description                         |
|--------------|-------------------------------------|
| DisplayIndex | Reserved for future use; must be 0. |
| Color        | RGB value of the color.             |

#### Additional information

These functions can be used to simulate the true background color of your display. The default color values are black and white, or 0x000000 and 0xFFFFFFFF. Refer to SIM\_GUI\_SetLCDColorBlack() for an example.

#### Example using default settings

```
void SIM_X_Config() {
    SIM_GUI_SetLCDPos(14,84); // Define the position of the LCD
                              // in the bitmap
    SIM_GUI_SetLCDColorBlack (0, 0x000000); // Define the color used as black
    SIM_GUI_SetLCDColorWhite (0, 0xFFFFFFFF); // Define the color used as white
    (used for colored monochrome displays)
}
```

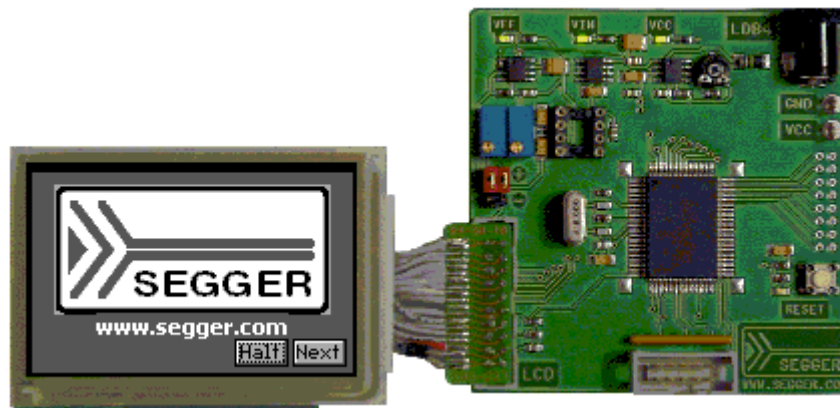

#### Example using yellow instead of white

```
void SIM_X_Config() {
    SIM_GUI_SetLCDPos(14,84); // Define the position of the LCD
                              // in the bitmap
    SIM_GUI_SetLCDColorBlack (0, 0x000000); // Define the color used as black
    SIM_GUI_SetLCDColorWhite (0, 0x00FFFF); // Define the color used as white
    (used for colored monochrome displays)
}
```

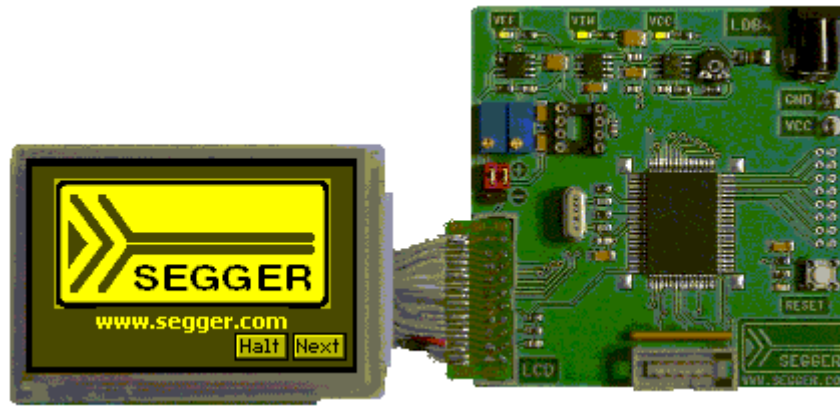

### 4.3.1.16 SIM\_GUI\_SetLCDPos()

#### Description

Sets the position for the simulated LCD within the target device bitmap.

#### Prototype

```
void SIM_GUI_SetLCDPos(int xPos,  
                      int yPos);
```

#### Parameters

| Parameter | Description  |
|-----------|--|
| xPos      | X-position of the upper left corner for the simulated LCD (in pixels). |
| yPos      | Y-position of the upper left corner for the simulated LCD (in pixels). |

#### Additional information

The X- and Y-positions are relative to the target device bitmap, therefore position (0,0) refers to the upper left corner (origin) of the bitmap and not your actual LCD. Only the origin of the simulated screen needs to be specified; the resolution of your display should already be reflected in the configuration files in the Config directory. The use of this function enables the use of the bitmaps Device.bmp and Device1.bmp . Note that the values need to be  $\geq 0$  for enabling the use of the bitmaps. If the use of the device bitmaps should be disabled, omit the call of this function in `SIM_X_Init()`.

### 4.3.1.17 SIM\_GUI\_SetMag()

#### Description

Sets magnification factors for X and/or Y axis.

#### Prototype

```
void SIM_GUI_SetMag(int MagX,  
                   int MagY);
```

#### Parameters

| Parameter | Description                      |
|-----------|----------------------------------|
| MagX      | Magnification factor for X axis. |
| MagY      | Magnification factor for Y axis. |

#### Additional information

Per default the simulation uses one pixel on the PC for each pixel of the simulated display. The use of this function makes sense for small displays. If using a device bit- map together with a magnification > 1 the device bitmap needs to be adapted to the magnification. The device bitmap is not magnified automatically.

### 4.3.1.18 SIM\_GUI\_SetTransColor()

#### Description

Sets the color to be used for transparent areas of device or hardkey bitmaps.

#### Prototype

```
int SIM_GUI_SetTransColor(int Color);
```

#### Parameters

| Parameter | Description   |
|-----------|---|
| Color     | RGB value of the color in the format 00000000RRRRRRRRGGGGGGGGBBBBBBB. |

#### Additional information

The default setting for transparency is bright red (0xFF0000). You would typically only need to change this setting if your bitmap contains the same shade of red.

### 4.3.1.19 SIM\_GUI\_SetTransMode()

#### Description

Sets the transparency mode for the given layer.

#### Prototype

```
void SIM_GUI_SetTransMode(int LayerIndex,  
                          int TransMode);
```

#### Parameters

| Parameter                  | Description  |
|----------------------------|--|
| <a href="#">LayerIndex</a> | Index of the layer for which the transparency mode should be set.        |
| <a href="#">TransMode</a>  | Permitted values are listed under <i>Transparency modes</i> on page 199. |

### 4.3.1.20 SIM\_GUI\_ShowDevice()

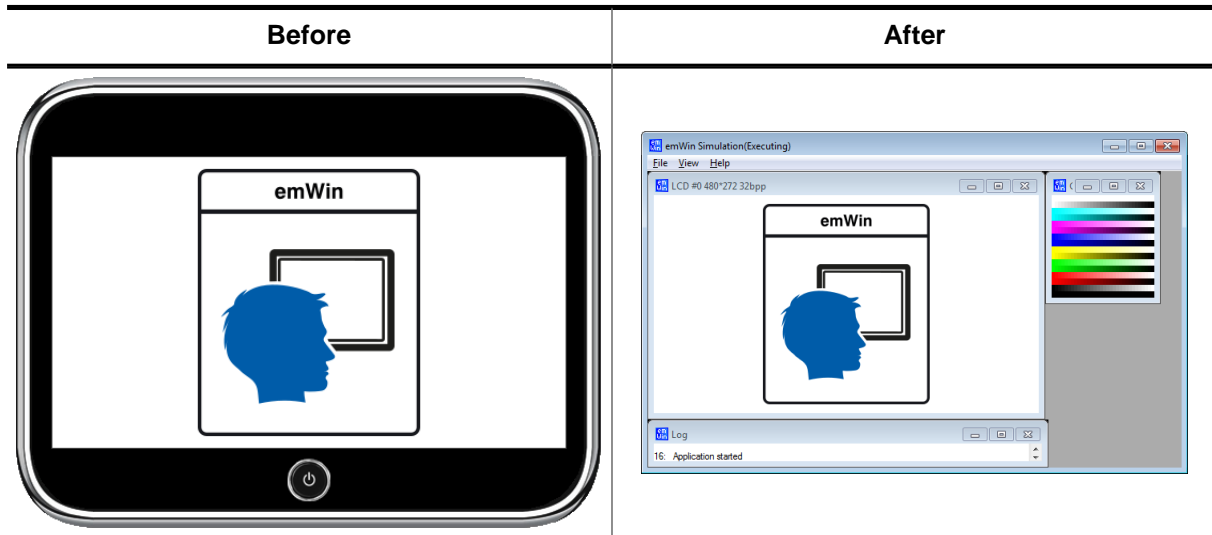

#### Description

When using multiple layers, this function can be used to show the device bitmap. By default each layer and the composite view are displayed in separate windows.

#### Prototype

```
void SIM_GUI_ShowDevice(int OnOff);
```

#### Parameters

| Parameter | Description                                |
|-----------|--|
| OnOff     | 1 for showing the bitmap, 0 for hiding it. |

#### Additional information

If using a multi-layer configuration and showing the device bitmap, only the composite view is shown. Because of this, the routine `SIM_GUI_SetCompositeSize()` also needs to be called in `SIM_X_Config()`.



### 4.3.1.21 SIM\_GUI\_UseCustomBitmaps()

#### Description

As described earlier in this chapter it is possible to use device bitmaps from the application resources. This function tells the simulation to use the device- and hardkey bitmaps from the application resources and not to generate the default frame bitmap.

#### Prototype

```
void SIM_GUI_UseCustomBitmaps(void);
```

#### Additional information

The emWin shipment contains per default 2 bitmaps, Device.bmp and Device1.bmp, located in `Start\System\Simulation\Res` which can be used as a starting point for your own bitmaps.

## 4.3.2 Data structures

### 4.3.2.1 SIM\_GUI\_INFO

#### Description

Contains the window handles of the simulation. This structure is required for `SIM_GUI_Set-Callback()`.

#### Type definition

```
typedef struct {
    HWND  hWndMain;
    HWND  ahWndLCD[];
    HWND  ahWndColor[];
} SIM_GUI_INFO;
```

#### Structure members

| Member                  | Description                             |
|-------------------------|---|
| <code>hWndMain</code>   | Handle to the main window.              |
| <code>ahWndLCD</code>   | Array of handles to the display layers. |
| <code>ahWndColor</code> | Array of handles to the palette layers. |

## 4.3.3 Defines

### 4.3.3.1 Transparency modes

#### Description

Available transparency modes for layers.

#### Definition

```
#define GUI_TRANSMODE_PIXELALPHA 0
#define GUI_TRANSMODE_ZERO 2
```

#### Symbols

| Definition                               | Description  |
|--|--|
| <a href="#">GUI_TRANSMODE_PIXELALPHA</a> | The alpha value is taken from the pixel data in order to mix colors with the according background. |
| <a href="#">GUI_TRANSMODE_ZERO</a>       | In this mode pixels are fully transparent if the pixel data equals 0.                              |

## 4.4 Hardkey simulation

The hardkey simulation can only be used in the custom bitmap view. Hardkeys may also be simulated as part of the device, and may be selected with the mouse pointer. The idea is to be able to distinguish whether a key or button on the simulated device is pressed or unpressed. A hardkey is considered “pressed” as long as the mouse button is held down; releasing the mouse button or moving the pointer off of the hardkey releases the key. A toggle behavior between pressed and unpressed may also be specified with the routine `SIM_HARDKEY_SetMode()`. In order to simulate hardkeys, you need a second bitmap of the device which is transparent except for the keys themselves (in their pressed state). As described earlier in this chapter, this bitmap can be in a separate file in the directory, or included as a resource in the executable. Hardkeys may be any shape, as long as they are exactly the same size in pixels in both `Device.bmp` and `Device1.bmp`. The following example illustrates this:

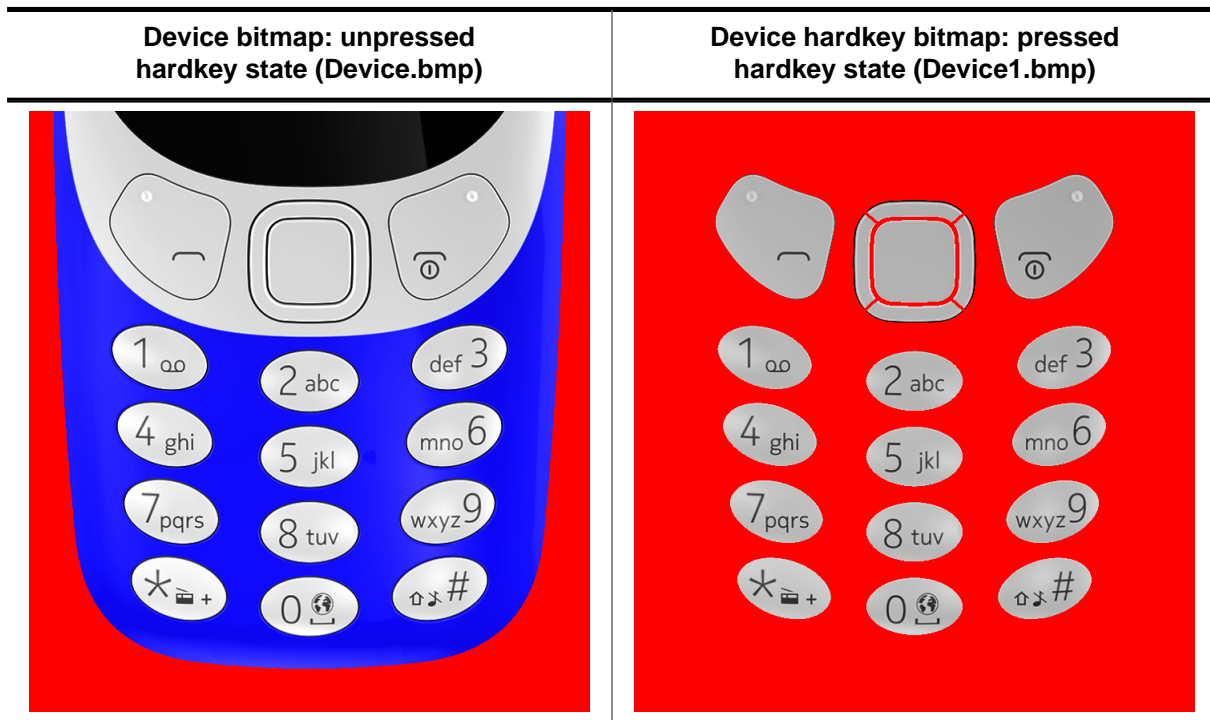

When a key is “pressed” with the mouse, the corresponding section of the hardkey bitmap (`Device1.bmp`) will overlay the device bitmap in order to display the key in its pressed state. The keys may be polled periodically to determine if their states (pressed/unpressed) have changed and whether they need to be updated. Alternatively, a callback routine may be set to trigger a particular action to be carried out when the state of a hardkey changes.

### 4.4.1 Hardkey simulation API

The hardkey simulation functions are part of the standard simulation program shipped with emWin. If using a user defined emWin simulation these functions may not be available. The table below lists the available hardkey-simulation-related routines in alphabetical order within their respective categories. Detailed descriptions of the routines follow:

| Routine                                   | Description   |
|---|---|
| <a href="#">SIM_HARDKEY_GetNum()</a>      | Returns the number of available hardkeys.   |
| <a href="#">SIM_HARDKEY_GetState()</a>    | Returns the state of a specified hardkey.   |
| <a href="#">SIM_HARDKEY_SetCallback()</a> | Sets a callback routine to be executed when the state of a specified hardkey changes. |
| <a href="#">SIM_HARDKEY_SetMode()</a>     | Sets the behavior for a specified hardkey.  |
| <a href="#">SIM_HARDKEY_SetState()</a>    | Sets the behavior for a specified hardkey.  |

### 4.4.1.1 SIM\_HARDKEY\_GetNum()

#### Description

Returns the number of available hardkeys.

#### Prototype

```
int SIM_HARDKEY_GetNum(void);
```

#### Return value

The number of available hardkeys found in the bitmap.

#### Additional information

The numbering order for hardkeys is standard reading order (left to right, then top to bottom). The topmost pixel of a hardkey is therefore found first, regardless of its horizontal position. In the bitmap below, for example, the hardkeys are labeled as they would be referenced by the [KeyIndex](#) parameter in other functions:

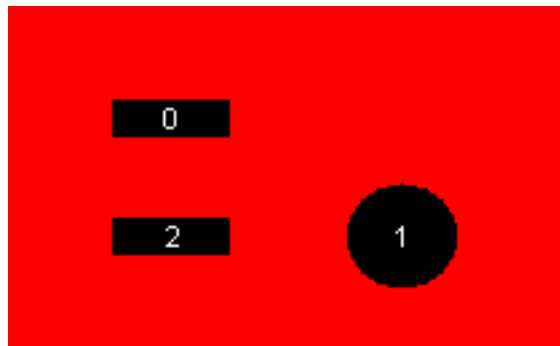

It is recommended to call this function in order to verify that a bitmap is properly loaded.

### 4.4.1.2 SIM\_HARDKEY\_GetState()

#### Description

Returns the state of a specified hardkey.

#### Prototype

```
int SIM_HARDKEY_GetState(unsigned int i);
```

#### Parameters

| Parameter             | Description                                |
|-----------------------|--|
| <code>KeyIndex</code> | Index of hardkey (0 = index of first key). |

#### Return value

State of the specified hardkey.

- 0       unpressed.
- 1       pressed.

### 4.4.1.3 SIM\_HARDKEY\_SetCallback()

#### Description

Sets a callback routine to be executed when the state of a specified hardkey changes.

#### Prototype

```
SIM_HARDKEY_CB *SIM_HARDKEY_SetCallback(unsigned int    KeyIndex,
                                         SIM_HARDKEY_CB * pfCallback);
```

#### Parameters

| Parameter                  | Description                                |
|----------------------------|--|
| <a href="#">KeyIndex</a>   | Index of hardkey (0 = index of first key). |
| <a href="#">pfCallback</a> | Pointer to callback routine.               |

#### Return value

Pointer to the previous callback routine.

#### Additional information

Note that multi tasking support has to be enabled if GUI functions need to be called within the callback functions. Without multi tasking support only the GUI functions which are allowed to be called within an interrupt routine should be used. The callback routine must have the following prototype:

#### Prototype of SIM\_HARDKEY\_CB

```
void SIM_HARDKEY_CB(int KeyIndex,
                    int State);
```

| Parameter                | Description   |
|--------------------------|---|
| <a href="#">KeyIndex</a> | Index of hardkey (0 = index of first key).                      |
| <a href="#">State</a>    | State of the specified hardkey. 0 for unpressed, 1 for pressed. |

#### 4.4.1.4 SIM\_HARDKEY\_SetMode()

##### Description

Sets the behavior for a specified hardkey.

##### Prototype

```
int SIM_HARDKEY_SetMode(unsigned int KeyIndex,  
                        int Mode);
```

##### Parameters

| Parameter                | Description  |
|--------------------------|--|
| <a href="#">KeyIndex</a> | Index of hardkey (0 = index of first key).                             |
| <a href="#">Mode</a>     | Behavior mode. 0 for normal behavior (default), 1 for toggle behavior. |

##### Additional information

Normal (default) hardkey behavior means that a key is considered pressed only as long as the mouse button is held down on it. When the mouse is released or moved off of the hardkey, the key is considered unpressed.

With toggle behavior, each click of the mouse toggles the state of a hardkey to pressed or unpressed. That means if you click the mouse on a hardkey and it becomes pressed, it will remain pressed until you click the mouse on it again.



### 4.4.1.5 SIM\_HARDKEY\_SetState()

#### Description

Sets the behavior for a specified hardkey.

#### Prototype

```
int SIM_HARDKEY_SetState(unsigned int i,  
                        int State);
```

#### Parameters

| Parameter                | Description  |
|--------------------------|--|
| <a href="#">KeyIndex</a> | Index of hardkey (0 = index of first key).                       |
| <a href="#">State</a>    | <a href="#">State</a> of the specified hardkey. See table below. |

#### Return value

Previous state of the key updated.

#### Additional information

This function is only usable when `SIM_HARDKEY_SetMode()` is set to 1 (toggle mode).

## 4.5 Integrating the emWin simulation into an existing simulation

In order to integrate the emWin simulation into an existing simulation, the source code of the simulation is not required. Only in some rare cases it is required to use the source code of the simulation. If required the source code of the simulation can be purchased separately and it is not part of a normal emWin shipment.

As described earlier in this chapter the basic package and the trial version contains a simulation library. The API functions of this library can be used if for example the emWin simulation should be added to an existing hardware or real time kernel (RTOS) simulation.

To add the emWin simulation to an existing simulation (written in C or C++, using the Win32 API), only a few lines of code need to be added.

### 4.5.1 Directory structure

The subfolder Simulation of the System folder contains the emWin simulation. The directory structure is shown on the right. The table below explains the contents of the subfolders:

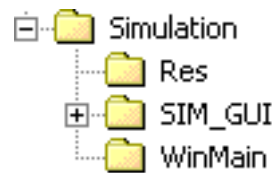

| Directory  | Content  |
|------------|--|
| Simulation | Simulation source and header files to be used with and without the simulation source code. The folder also contains a ready to use simulation library. |
| Res        | Resource files.  |
| SIM_GUI    | GUI simulation source code (optional).   |
| WinMain    | Contains the WinMain routine.  |

### 4.5.2 Using the simulation library

The following steps will show how to use the simulation library to integrate the emWin simulation into an existing simulation:

- **Step 1:** Add the simulation library `GUISim.lib` to the project.
- **Step 2:** Add all GUI files to the project as described in the chapter *Subdirectories* on page 86.
- **Step 3:** Add the include directories to the project as described in the chapter *Include Directories*.
- **Step 4:** Modify `WinMain()` or `SIM_OS.c`.

#### 4.5.2.1 Modifying WinMain

Every windows Win32 program starts with `WinMain()` (contrary to a normal C program from the command line, which starts with `main()`). All that needs to be done is to add a few lines of code to this routine.

The following function calls need to be added (normally in the order as it is shown in the following application code example):

- `SIM_GUI_Enable()`
- `SIM_GUI_Init()`
- `SIM_GUI_CreateLCDWindow()`
- `CreateThread()`
- `SIM_GUI_Exit()`

## 4.5.2.2 Example application

The following application is available under `Sample\WinMain\SampleApp.c` and shows how to integrate the emWin simulation into an existing application:

```
#include <windows.h>
#include "GUI_SIM_Win32.h"
void MainTask(void);
/*****
 *
 *      _Thread
 */
static DWORD __stdcall _Thread(void * Parameter) {
    MainTask();
    return 0;
}
/*****
 *
 *      _WndProcMain
 */
static LRESULT CALLBACK _WndProcMain(HWND hWnd, UINT message,
                                     WPARAM wParam, LPARAM lParam) {
    SIM_GUI_HandleKeyEvents(message, wParam);
    switch (message) {
        case WM_DESTROY:
            PostQuitMessage(0);
            break;
    }
    return DefWindowProc(hWnd, message, wParam, lParam);
}
/*****
 *
 *      _RegisterClass
 */
static void _RegisterClass(HINSTANCE hInstance) {
    WNDCLASSEX wcex;
    memset(&wcex, 0, sizeof(wcex));
    wcex.cbSize = sizeof(WNDCLASSEX);
    wcex.hInstance = hInstance;
    wcex.style = CS_HREDRAW | CS_VREDRAW;
    wcex.lpfnWndProc = (WNDPROC)_WndProcMain;
    wcex.hIcon = 0;
    wcex.hCursor = LoadCursor(NULL, IDC_ARROW);
    wcex.hbrBackground = (HBRUSH)(COLOR_APPWORKSPACE + 1);
    wcex.lpszMenuName = 0;
    wcex.lpszClassName = "GUIApplication";
    RegisterClassEx(&wcex);
}
/*****
 *
 *      WinMain
 */
int APIENTRY WinMain(HINSTANCE hInstance, HINSTANCE hPrevInstance,
                    LPSTR lpCmdLine, int nCmdShow) {
    DWORD ThreadID;
    MSG Msg;
    HWND hWndMain;
    //
    // Register window class
    //
    _RegisterClass(hInstance);
    //
    // Make sure the driver configuration is done
    //
    SIM_GUI_Enable();
    //
    // Create main window
```

```

//
hWndMain = CreateWindow("GUIApplication", "Application window",
                       WS_OVERLAPPEDWINDOW | WS_CLIPCHILDREN | WS_VISIBLE,
                       0, 0, 328, 267, NULL, NULL, hInstance, NULL);

//
// Initialize the emWin simulation and create an LCD window
//
SIM_GUI_Init(hInstance, hWndMain, lpCmdLine, "embOS - emWin Simulation");
SIM_GUI_CreateLCDWindow(hWndMain, 0, 0, 320, 240, 0);
//
// Create a thread which executes the code to be simulated
//
CreateThread(NULL, 0, (LPTHREAD_START_ROUTINE)_Thread, NULL, 0, &ThreadID);
//
// Main message loop
//
while (GetMessage(&Msg, NULL, 0, 0)) {
    TranslateMessage(&Msg);
    DispatchMessage(&Msg);
}
SIM_GUI_Exit();
}

```

## 4.5.3 Integration into the embOS Simulation

### 4.5.3.1 SIM\_OS.c

The following code example shows how to modify the existing `SIM_OS.c` of the embOS simulation in order to integrate the emWin simulation. Only four lines of coded have to be added to the function `_WindowThread()`. Add an include of `GUI_SIM_Win32.h` and the three function calls with prefix `SIM_GUI_<FunctionName>()` as shown below:

```

...
#include "GUI_SIM_Win32.h"
...
static DWORD WINAPI _WindowThread(LPVOID lpParameter) {
    BITMAP    BmpDevice;
    HINSTANCE hInstance;
    HACCEL    hAcceleratorTable;
    MSG       Msg;

    OS_USEPARA(lpParameter);
    //
    // Create a window. This window is used to simulate blinking LEDs.
    //
    _RegisterClass();
    hInstance = GetModuleHandle(NULL);
    hAcceleratorTable = LoadAccelerators(hInstance,
                                        MAKEINTRESOURCE(SIM_OS_IDC_WINMAIN));

    _hBmpDevice
    = (HBITMAP)LoadImage(hInstance, MAKEINTRESOURCE(SIM_OS_IDB_DEVICE),
                       IMAGE_BITMAP, 0, 0, 0);

    _hMenuPopup
    = LoadMenu(hInstance, MAKEINTRESOURCE(SIM_OS_IDC_CONTEXTMENU));
    _hMenuPopup = GetSubMenu(_hMenuPopup, 0);
    //
    // Create main window
    //
    GetObject(_hBmpDevice, sizeof(BmpDevice), &BmpDevice);
    _hWnd = CreateWindowEx(0, _sWindowClass, "embOS Simulation",
                          WS_SYSMENU | WS_CLIPCHILDREN | WS_POPUP | WS_VISIBLE,
                          10, 20, BmpDevice.bmWidth, BmpDevice.bmHeight, NULL,
                          NULL, hInstance, NULL);

    if (_hWnd == NULL) {
        _ErrorWin32("Could not create window.");
    }
}

```

```

    return -1; // Error
}
//
// Init emWin simulation and create window
//
SIM_GUI_Enable();
SIM_GUI_Init(hInstance, _hWnd, "", "embOS - emWin Simulation");
SIM_GUI_CreateLCDWindow(_hWnd, 0, 0, 320, 240, 0);
//
// Show main window
//
ShowWindow(_hWnd, SW_SHOWNORMAL);
#ifdef SIM_OS_TIMER_PERIOD && (SIM_OS_TIMER_PERIOD != 0)
//
// Create a timer which is periodically invalidating the Win32 window in order
// to redraw it
//
SetTimer(_hWnd, 0, SIM_OS_TIMER_PERIOD, _cbTimer);
#endif
//
// Handle message loop
//
while (GetMessage(&Msg, NULL, 0, 0)) {
    if (!TranslateAccelerator(_hWnd, hAcceleratorTable, &Msg)) {
        TranslateMessage(&Msg);
        DispatchMessage(&Msg);
    }
}
ExitProcess(0);
return 0;
}

```

### 4.5.3.2 Target program (main)

The emWin API can be called from one or more target threads. Without RTOS, the WIN32 API function `CreateThread` is normally used to create a target thread which calls the emWin API; within an RTOS simulation, a target task/thread (Created by the simulated RTOS) is used to call the emWin API. In other words: Use `OS_CreateTask` to create a task for the user interface. Below a modified embOS start application:

```

#include <windows.h>
#include "RTOS.H"
#include "HW_LED.h"
#include "GUI.h"
OS_STACKPTR int Stack0[128], Stack1[128], Stack2[2000]; // Task stacks
OS_TASK      TCB0,      TCB1,      TCB2; // Task-control-blocks
void Task0(void) {
    while (1) {
        HW_LED_Toggle0();
        OS_Delay(100);
    }
}
void Task1(void) {
    while (1) {
        HW_LED_Toggle1();
        OS_Delay(500);
    }
}
void MainTask(void) {
    int i;
    GUI_COLOR aColor[] = {GUI_RED, GUI_YELLOW};
    GUI_Init();
    while (1) {
        for (i = 0; i < 2; i++) {
            GUI_Clear();
            GUI_SetColor(aColor[i]);

```

```

GUI_SetFont(&GUI_FontComic24B_ASCII);
GUI_DispStringAt("Hello world!", 1, 1);
OS_Delay(200);
}
}
}
}
/*****
*
*      main
*/
void main(void) {
    OS_IncDI();           // Initially disable interrupts
    OS_InitKern();       // Initialize OS
    OS_InitHW();        // Initialize Hardware for OS
    //
    // At least one task here needs to be created here
    //
    OS_CREATETASK(&TCB0, "HP Task", Task0, 100, Stack0);
    OS_CREATETASK(&TCB1, "LP Task", Task1, 50, Stack1);
    OS_CREATETASK(&TCB2, "GUI Task", MainTask, 80, Stack2);
    OS_Start();         // Start multitasking
}

```

The following table shows the simulation before and after integrating the emWin simulation:

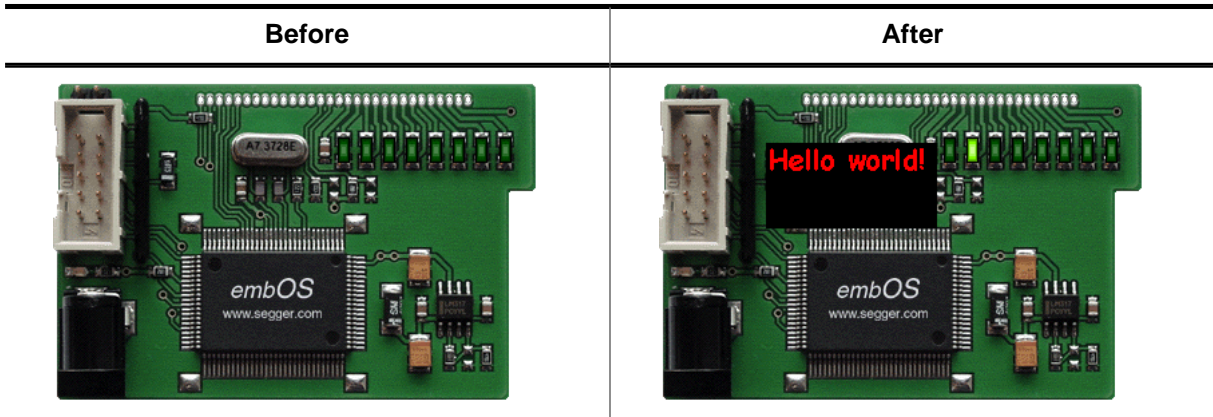

### 4.5.4 GUI simulation API

The table below lists the available routines for user defined simulation programs in alphabetical order within their respective categories. The functions are only available with the source code of the emWin simulation. Detailed descriptions of the routines follow:

| Routine                                    | Description   |
|--|---|
| <code>SIM_GUI_CreateLCDInfoWindow()</code> | Creates a window which shows the available colors for the given layer.                      |
| <code>SIM_GUI_CreateLCDWindow()</code>     | Creates a window which simulates a LCD display with the given size at the given position.   |
| <code>SIM_GUI_Enable()</code>              | Executes memory and driver configuration.   |
| <code>SIM_GUI_Exit()</code>                | Stops the GUI simulation.   |
| <code>SIM_GUI_Init()</code>                | Initializes the GUI simulation.   |
| <code>SIM_GUI_SetLCDWindowHook()</code>    | Sets a hook function to be called from the simulation if the LCD window receives a message. |

### 4.5.4.1 SIM\_GUI\_CreateLCDInfoWindow()

#### Description

Creates a window which shows the available colors for the given layer.

#### Prototype

```
HWND SIM_GUI_CreateLCDInfoWindow(HWND hParent,
                                int x,
                                int y,
                                int xSize,
                                int ySize,
                                int LayerIndex);
```

#### Parameters

| Parameter               | Description   |
|-------------------------|---|
| <code>hParent</code>    | Handle of the parent window.  |
| <code>x</code>          | X position in parent coordinates.   |
| <code>y</code>          | Y position in parent coordinates.   |
| <code>xSize</code>      | X size in pixel of the new window. Should be 160 if using a color depth between 1 and 8 or 128 if working in high color mode. |
| <code>ySize</code>      | Y size in pixel of the new window. Should be 160 if using a color depth between 1 and 8 or 128 if working in high color mode. |
| <code>LayerIndex</code> | Index of the layer to be shown.   |

#### Return value

Handle of the created window.

#### Additional information

The created color window has no frame, no title bar and no buttons.

#### Example

```
SIM_GUI_CreateLCDInfoWindow(hWnd, 0, 0, 160, 160, 0);
```

#### Screenshot



### 4.5.4.2 SIM\_GUI\_CreateLCDWindow()

#### Description

Creates a window which simulates a LCD display with the given size at the given position.

#### Prototype

```
HWND SIM_GUI_CreateLCDWindow(HWND hParent,
                             int x,
                             int y,
                             int xSize,
                             int ySize,
                             int LayerIndex);
```

#### Parameters

| Parameter               | Description                        |
|-------------------------|------------------------------------|
| <code>hParent</code>    | Handle of the parent window.       |
| <code>x</code>          | X position in parent coordinates.  |
| <code>y</code>          | Y position in parent coordinates.  |
| <code>xSize</code>      | X size in pixel of the new window. |
| <code>ySize</code>      | Y size in pixel of the new window. |
| <code>LayerIndex</code> | Index of the layer to be shown.    |

#### Return value

Handle of the created window.

#### Additional information

All display output to the given layer will be shown in this window. The size of the window should be the same as configured in LCDConf.c. The created simulation window has no frame, no title bar and no buttons.



### 4.5.4.3 SIM\_GUI\_Enable()

#### Description

The function needs to be called at the beginning of the application to make sure that memory and driver will be configured at first.

#### Prototype

```
void SIM_GUI_Enable(void);
```

#### 4.5.4.4 SIM\_GUI\_Exit()

##### Description

The function should be called before the simulation returns to the calling process.

##### Prototype

```
void SIM_GUI_Exit(void);
```

### 4.5.4.5 SIM\_GUI\_Init()

#### Description

This function initializes the emWin simulation and should be called before any other SIM\_GUI... function call.

#### Prototype

```
int SIM_GUI_Init(           HINSTANCE  hInst,
                           HWND        hWndMain,
                           char        * pCmdLine,
                           const char  * sAppName);
```

#### Parameters

| Parameter                | Description   |
|--------------------------|---|
| <a href="#">hInst</a>    | Handle to current instance passed to WinMain.           |
| <a href="#">hWndMain</a> | Handle to current instance passed to WinMain.           |
| <a href="#">pCmdLine</a> | Pointer to command line passed to WinMain               |
| <a href="#">sAppName</a> | Pointer to a string that contains the application name. |

#### Return value

0        on success  
1        on error.

#### Additional information

The parameters [hWndMain](#) and [sAppName](#) are used in case a message box should be displayed.

#### 4.5.4.6 SIM\_GUI\_SetLCDWindowHook()

##### Description

Sets a hook function to be called from the simulation if the LCD window receives a message.

##### Prototype

```
void SIM_GUI_SetLCDWindowHook(SIM_GUI_tfHook * pHook);
```

##### Parameters

| Parameter             | Description               |
|-----------------------|---------------------------|
| <a href="#">pHook</a> | Pointer to hook function. |

##### Return value

The hook function should return 0 if the message has been processed. In this case the GUI simulation ignores the message.

# Chapter 5

## Basic features

---

The following chapter contains all basic emWin features. These features are all part of the **emWin BASE package**.

- Displaying Text
- Displaying Values
- 2-D Graphic Library
- Displaying bitmap files
- Colors
- Fonts
- Animations
- Movies
- Pointer Input Devices
- Multiple Buffering
- Keyboard Input
- Language Support
- Timing- and execution-related functions

## 5.1 Displaying Text

It is very easy to display text with emWin. Knowledge of only a few routines already allows you to write any text, in any available font, at any point on the display. We first provide a short introduction to displaying text, followed by more detailed descriptions of the individual routines that are available.

### 5.1.1 Basic routines

Text can be displayed just by calling `GUI_DispString()`. For example:

```
GUI_DispString("Hello world!");
```

The above code will display the text "Hello world" at the current text position. However, there are functions to display text using different fonts or at certain positions. Even when using byte-oriented displays the position can be specified pixel accurate. In addition to that, it is also possible to display decimal, hexadecimal and binary values. Details on how values can be displayed using emWin can be found in the chapter *Displaying Values* on page 257.

#### Control characters

Control characters are characters with a character code of less than 32. The control characters are defined as part of ASCII. emWin ignores all control characters except the following:

| Char. Code | ASCII code | C  | Description   |
|------------|------------|----|---|
| 10         | LF         | \n | Line feed.<br>The current text position is changed to the beginning of the next line.<br>Per default, this is: X = 0.<br>Y += font-distance in pixels (as delivered by <code>GUI_GetFontDistY()</code> ). |

#### Note

emWin does not interpret carriage return (\r) characters! Only new line characters (\n) should be used to display text in a new line!

## 5.1.2 Drawing modes

Text is displayed using the foreground and background color which are set using the functions `GUI_SetColor()` and `GUI_SetBkColor()` described below. In order to set a certain drawing mode to display strings or single characters the function `GUI_SetTextMode()` can be called using the flags described below.

### Normal text

Displaying normal text is the default behavior. The characters are displayed using the foreground color. The background color is used to clear the background according to its width of the text and height of the currently selected font. Text can be displayed normally by specifying just `GUI_TM_NORMAL` or 0.

### Reverse text

Text can be displayed in reverse mode by specifying `GUI_TM_REV`. This causes characters to be displayed using the background color and the background to be cleared using the foreground color.

### Transparent text

Text can be displayed in transparent mode by specifying `GUI_TM_TRANS`. This causes characters to be displayed without the background to be cleared. In this case whatever was drawn before the text was displayed can still be seen.

### XOR text

Text can be displayed in XOR mode by specifying `GUI_TM_XOR`. This causes characters to be displayed using the inverted colors of the background. This is done pixel-wise. This is also a transparent drawing mode, so the background remains unchanged. This mode is often used to in 1bpp-configurations to ensure readability, since black is inverted to white and vice versa. In case colors are used a single pixel is inverted as follows:

```
New pixel color = number of colors - actual pixel color - 1
```

### Transparent reversed text

Text can be displayed in reverse and transparent mode by specifying `(GUI_TM_TRANS | GUI_TM_REV)`. According to the transparent mode, the background is not cleared. According to the reverse mode, the characters are displayed using the background color.

### Example

Displays normal, reverse, transparent, XOR, and transparent reversed text:

```
GUI_SetFont(&GUI_Font8x16);
GUI_SetBkColor(GUI_BLUE);
GUI_Clear();
GUI_SetPenSize(10);
GUI_SetColor(GUI_RED);
GUI_DrawLine(80, 10, 240, 90);
GUI_DrawLine(80, 90, 240, 10);
GUI_SetBkColor(GUI_BLACK);
GUI_SetColor(GUI_WHITE);
GUI_SetTextMode(GUI_TM_NORMAL);
GUI_DispStringHCenterAt("GUI_TM_NORMAL", 160, 10);
GUI_SetTextMode(GUI_TM_REV);
GUI_DispStringHCenterAt("GUI_TM_REV", 160, 26);
GUI_SetTextMode(GUI_TM_TRANS);
GUI_DispStringHCenterAt("GUI_TM_TRANS", 160, 42);
GUI_SetTextMode(GUI_TM_XOR);
GUI_DispStringHCenterAt("GUI_TM_XOR", 160, 58);
GUI_SetTextMode(GUI_TM_TRANS | GUI_TM_REV);
```

```
GUI_DispStringHCenterAt("GUI_TM_TRANS | GUI_TM_REV", 160, 74);
```

### Screenshot of above example





### 5.1.3 Position

Every task has a current text position. This is the position relative to the origin of the display. This position is used by text displaying functions to place the next characters. Initially this position is (0,0) which is the upper left corner of the display. When using the Window Manager the position is used according to the current window. In order to set the text position the function `GUI_GotoX()`, `GUI_GotoY()` and `GUI_GotoXY()` can be used.

## 5.1.4 Text API

The table below lists the available text-related functions in alphabetical order within their respective categories. Detailed function descriptions can be found in the following sections.

### Functions

| Routine                                     | Description   |
|---|---|
| Displaying text                             |   |
| <code>GUI_DispCEOL()</code>                 | Clears the current line from the current position to the end.   |
| <code>GUI_DispChar()</code>                 | Displays a single character.  |
| <code>GUI_DispCharAt()</code>               | Displays a single character at the specified position.  |
| <code>GUI_DispChars()</code>                | Displays a character a specified number of times.   |
| <code>GUI_DispString()</code>               | Displays a string.  |
| <code>GUI_DispStringAt()</code>             | Displays a string at the specified position.  |
| <code>GUI_DispStringAtCEOL()</code>         | Displays a string at the specified position and clears the current line to the end.   |
| <code>GUI_DispStringHCenterAt()</code>      | Displays a string centered horizontally at the given position.  |
| <code>GUI_DispStringInRect()</code>         | Displays a string in the specified rectangle.   |
| <code>GUI_DispStringInRectEx()</code>       | Displays a string rotated in the specified rectangle.   |
| <code>GUI_DispStringInRectWrap()</code>     | Displays a string wrapped in the specified rectangle.   |
| <code>GUI_DispStringInRectWrapEx()</code>   | Displays a string rotated and wrapped in the specified rectangle.   |
| <code>GUI_DispStringLength()</code>         | Displays a string at the current position with specified number of characters.  |
| <code>GUI_GetCharFromPos()</code>           | Returns a character from a string at a given X-position in the current font.  |
| <code>GUI_GetShowMissingCharacters()</code> | Returns if showing of missing characters is enabled or not.   |
| <code>GUI_ShowMissingCharacters()</code>    | This function enables displaying of missing characters.   |
| <code>GUI_WrapGetNumLines()</code>          | Returns the number of lines required to display the given text with the given wrap mode at the given size using the current font. |
| Drawing modes                               |   |
| <code>GUI_GetTextMode()</code>              | Returns the currently selected text mode.   |
| <code>GUI_SetClearTextRectMode()</code>     | Enables or disables the clear text rect mode.   |
| <code>GUI_SetTextMode()</code>              | Sets the text mode to the parameter specified.  |
| <code>GUI_SetTextStyle()</code>             | Sets the text style to the parameter specified.   |
| Alignment                                   |   |
| <code>GUI_GetTextAlign()</code>             | Returns the current text alignment mode.  |
| <code>GUI_SetLBorder()</code>               | Sets the left border for line feeds in the current window.  |
| <code>GUI_SetTextAlign()</code>             | Sets the text alignment.  |

| Routine                         | Description   |
|---------------------------------|---|
|                                 | Position  |
| <code>GUI_DispNextLine()</code> | Moves the cursor to the beginning of the next line. |
| <code>GUI_GotoX()</code>        | Sets the X-position.                                |
| <code>GUI_GotoXY()</code>       | Sets the X- and Y-position.                         |
| <code>GUI_GotoY()</code>        | Sets the Y-position.                                |
| <code>GUI_GetDispPosX()</code>  | Returns the current X-position.                     |
| <code>GUI_GetDispPosY()</code>  | Returns the current Y-position.                     |

## Defines

| Group of defines                  | Description                                  |
|-----------------------------------|--|
| <code>Text alignment flags</code> | Define the alignment of a text.              |
| <code>Text drawing modes</code>   | Define with which mode a text will be drawn. |
| <code>Text rotation modes</code>  | Rotate the text.                             |
| <code>Text style flags</code>     | Text style how a text will be displayed.     |

## Enumerations

| Enumeration type          | Description                             |
|---------------------------|---|
| <code>GUI_WRAPMODE</code> | Configuration how text will be wrapped. |

## 5.1.4.1 Displaying text

### 5.1.4.1.1 GUI\_DispCEOL()

#### Description

Clears the current line in the current window (or the display) from the current text position to the end of the window using the height of the current font.

#### Prototype

```
void GUI_DispCEOL(void);
```

#### Example

Shows "Hello world" on the display, waits 1 second and then displays "Hi" in the same place, replacing the old string:

```
GUI_DispStringAt("Hello world", 0, 0);  
GUI_Delay(1000);  
GUI_DispStringAt("Hi", 0, 0);  
GUI_DispCEOL();
```

### 5.1.4.1.2 GUI\_Dispatch()

#### Description

Displays a single character at the current text position in the current window using the current font.

#### Prototype

```
void GUI_Dispatch(U16 c);
```

#### Parameters

| Parameter | Description          |
|-----------|----------------------|
| c         | Character to display |

#### Additional information

This is the basic routine for displaying a single character. All other display routines (`GUI_DispatchAt()`, `GUI_DispatchString()`, etc.) call this routine to output the individual characters. Which characters are available depends on the selected font. If the character is not available in the current font, nothing is displayed.

#### Example

Shows a capital A on the display:

```
GUI_Dispatch('A');
```

#### Related topics

- *GUI\_DispatchChars* on page 227
- *GUI\_DispatchAt* on page 226

### 5.1.4.1.3 GUI\_DispatchAt()

#### Description

Displays a single character at the specified position in the current window using the current font.

#### Prototype

```
void GUI_DispatchAt(U16 c,  
                   I16P x,  
                   I16P y);
```

#### Parameters

| Parameter      | Description  |
|----------------|--|
| <code>c</code> | Character to display                                   |
| <code>x</code> | X-position to write to in pixels of the client window. |
| <code>y</code> | Y-position to write to in pixels of the client window. |

#### Additional information

Displays the character with its upper left corner at the specified (X,Y) position. Writes the character using the routine `GUI_Dispatch()`. If the character is not available in the current font, nothing is displayed.

#### Example

Shows a capital A on the display in the upper left corner:

```
GUI_DispatchAt('A',0,0);
```

#### Related topics

- [GUI\\_Dispatch](#) on page 225
- [GUI\\_DispatchChars](#) on page 227

### 5.1.4.1.4 GUI\_DispChars()

#### Description

Displays a character a specified number of times at the current text position in the current window using the current font.

#### Prototype

```
void GUI_DispChars(U16P c,
                  int NumChars);
```

#### Parameters

| Parameter | Description   |
|-----------|---|
| c         | Character to display                                      |
| Cnt       | Number of repetitions ( $0 \leq \text{Cnt} \leq 32767$ ). |

#### Additional information

Writes the character using the routine `GUI_DispChar()` . If the character is not available in the current font, nothing is displayed.

#### Example

Shows the line `*****` on the display:

```
GUI_DispChars('*', 30);
```

#### Related topics

- `GUI_DispChar` on page 225
- `GUI_DispCharAt` on page 226

### 5.1.4.1.5 GUI\_DisString()

#### Description

Displays the string passed as parameter at the current text position in the current window using the current font.

#### Prototype

```
void GUI_DisString(const char * s);
```

#### Parameters

| Parameter | Description       |
|-----------|-------------------|
| s         | String to display |

#### Additional information

The string can contain the control character `\n`. This control character moves the current text position to the beginning of the next line.

#### Example

Shows "Hello world" on the display and "Next line" on the next line:

```
GUI_DisString("Hello world"); //Disp text  
GUI_DisString("\nNext line"); //Disp text
```

#### Related topics

- [GUI\\_DisStringAt](#) on page 229
- [GUI\\_DisStringAtCEOL](#) on page 230
- [GUI\\_DisStringLen](#) on page 236



### 5.1.4.1.6 GUI\_DispStringAt()

#### Description

Displays the string passed as parameter at a specified position in the current window using the current font.

#### Prototype

```
void GUI_DispStringAt(const char * s,  
                     int      x,  
                     int      y);
```

#### Parameters

| Parameter      | Description  |
|----------------|--|
| <code>s</code> | String to display                                      |
| <code>x</code> | X-position to write to in pixels of the client window. |
| <code>y</code> | Y-position to write to in pixels of the client window. |

#### Example

Shows "Position 50,20" at position 50,20 on the display:

```
GUI_DispStringAt("Position 50,20", 50, 20); // Disp text
```

#### Related topics

- *GUI\_DispString* on page 228
- *GUI\_DispStringAtCEOL* on page 230
- *GUI\_DispStringLen* on page 236

### 5.1.4.1.7 GUI\_DisStringAtCEOL()

#### Description

Displays a given string at a specified position and clearing the remaining part of the line to the end by calling the routine `GUI_DispCEOL()`. This routine can be handy if one string is to overwrite another, and the overwriting string is or may be shorter than the previous one.

#### Prototype

```
void GUI_DisStringAtCEOL(const char * s,  
                        int x,  
                        int y);
```

#### Parameters

| Parameter      | Description  |
|----------------|--|
| <code>s</code> | String to display                                      |
| <code>x</code> | X-position to write to in pixels of the client window. |
| <code>y</code> | Y-position to write to in pixels of the client window. |

### 5.1.4.1.8 GUI\_DisStringHCenterAt()

#### Description

Displays the string passed as parameter horizontally centered at a specified position in the current window using the current font.

#### Prototype

```
void GUI_DisStringHCenterAt(const char * s,  
                           int      x,  
                           int      y);
```

#### Parameters

| Parameter         | Description  |
|-------------------|--|
| <a href="#">s</a> | String to display                                      |
| <a href="#">x</a> | X-position to write to in pixels of the client window. |
| <a href="#">y</a> | Y-position to write to in pixels of the client window. |

### 5.1.4.1.9 GUI\_DispStringInRect()

#### Description

Displays the string passed as parameter at a specified position within a specified rectangle, in the current window using the current font.

#### Prototype

```
void GUI_DispStringInRect(const char * pText,
                        GUI_RECT * pRect,
                        int TextAlign);
```

#### Parameters

| Parameter              | Description   |
|------------------------|---|
| <code>s</code>         | String to display   |
| <code>pRect</code>     | Rectangle to write to in pixels of the client window.   |
| <code>TextAlign</code> | Text alignment mode to set. List of flags can be found under <i>Text alignment flags</i> on page 252. |

#### Additional information

If the specified rectangle is too small, the text will be clipped.

#### Example

Shows the word "Text" centered horizontally and vertically in the current window:

```
GUI_RECT rClient;
GUI_GetClientRect(&rClient);
GUI_DispStringInRect("Text", &rClient, GUI_TA_HCENTER | GUI_TA_VCENTER);
```

#### Related topics

- *GUI\_DispString* on page 228
- *GUI\_DispStringAtCEOL* on page 230
- *GUI\_DispStringLength* on page 236

### 5.1.4.1.10 GUI\_DispStringInRectEx()

#### Description

Displays the string passed as parameter at a specified position within a specified rectangle, in the current window using the current font and (optionally) rotates it.

#### Prototype

```
void GUI_DispStringInRectEx(const char      * s,
                           GUI_RECT      * pRect,
                           int           TextAlign,
                           int           MaxLen,
                           const GUI_ROTATION * pLCD_Api);
```

#### Parameters

| Parameter              | Description   |
|------------------------|---|
| <code>s</code>         | String to display   |
| <code>pRect</code>     | Rectangle to write to in pixels of the client window.   |
| <code>TextAlign</code> | Text alignment mode. List of flags can be found under <i>Text alignment flags</i> on page 252.      |
| <code>MaxLen</code>    | Maximum number of characters to be shown.   |
| <code>pLCD_Api</code>  | Text rotation mode. See full list of available values under <i>Text rotation modes</i> on page 254. |

#### Additional information

If the specified rectangle is too small, the text will be clipped. To make the function available the configuration switch `GUI_SUPPORT_ROTATION` must be activated (default).

#### Example

Shows the word "Text" centered horizontally and vertically in the given rectangle:

```
GUI_RECT Rect = {10, 10, 40, 80};
char acText[] = "Rotated\ntext";
GUI_SetTextMode(GUI_TM_XOR);
GUI_FillRectEx(&Rect);
GUI_DispStringInRectEx(acText, &Rect, GUI_TA_HCENTER | GUI_TA_VCENTER,
                      strlen(acText), GUI_ROTATE_CCW);
```

#### Screenshot of above example



### 5.1.4.1.11 GUI\_DispStringInRectWrap()

#### Description

Displays a string at a specified position within a specified rectangle, in the current window using the current font and (optionally) wraps the text.

#### Prototype

```
void GUI_DispStringInRectWrap(const char * s,
                             GUI_RECT * pRect,
                             int TextAlign,
                             GUI_WRAPMODE WrapMode);
```

#### Parameters

| Parameter              | Description  |
|------------------------|--|
| <code>s</code>         | String to display  |
| <code>pRect</code>     | Rectangle to write to in pixels of the client window.  |
| <code>TextAlign</code> | Text alignment mode. List of flags can be found under <i>Text alignment flags</i> on page 252. |
| <code>WrapMode</code>  | Text wrap mode. See full list of available values under <i>GUI_WRAPMODE</i> on page 256.       |

#### Example

Shows a text centered horizontally and vertically in the given rectangle with word wrapping:

```
GUI_WRAPMODE aWm[]
= { GUI_WRAPMODE_NONE, GUI_WRAPMODE_CHAR, GUI_WRAPMODE_WORD};
GUI_RECT Rect = {10, 10, 59, 59};
char acText[] = "This example demonstrates text wrapping";
int i;
GUI_SetTextMode(GUI_TM_TRANS);
for (i = 0; i < 3; i++) {
    GUI_SetColor(GUI_BLUE);
    GUI_FillRectEx(&Rect);
    GUI_SetColor(GUI_WHITE);
    GUI_DispStringInRectWrap(acText, &Rect, GUI_TA_LEFT, aWm[i]);
    Rect.x0 += 60;
    Rect.x1 += 60;
}
```

#### Screenshot of above example



### 5.1.4.1.12 GUI\_DispStringInRectWrapEx()

#### Description

Displays a string rotated at a specified position within a specified rectangle, in the current window using the current font and (optionally) wraps the text.

#### Prototype

```
void GUI_DispStringInRectWrapEx(const char      * s,
                                GUI_RECT      * pRect,
                                int           TextAlign,
                                GUI_WRAPMODE   WrapMode,
                                const GUI_ROTATION * pLCD_Api);
```

#### Parameters

| Parameter              | Description   |
|------------------------|---|
| <code>s</code>         | String to display.  |
| <code>pRect</code>     | Rectangle to write to in pixels of the client window.   |
| <code>TextAlign</code> | Text alignment mode. List of flags can be found under <i>Text alignment flags</i> on page 252.      |
| <code>WrapMode</code>  | Text wrap mode. See full list of available values under <i>GUI_WRAPMODE</i> on page 256.            |
| <code>pLCD_Api</code>  | Text rotation mode. See full list of available values under <i>Text rotation modes</i> on page 254. |

### 5.1.4.1.13 GUI\_DispStringLen()

#### Description

Displays the string passed as parameter with a specified number of characters at the current text position, in the current window using the current font.

#### Prototype

```
void GUI_DispStringLen(const char * s,  
                      int      MaxNumChars);
```

#### Parameters

| Parameter                   | Description   |
|-----------------------------|---|
| <a href="#">s</a>           | Should be a terminated array of 8-bit characters. Passing NULL as parameter is permitted. |
| <a href="#">MaxNumChars</a> | Number of characters to display.  |

#### Additional information

If the string has less characters than specified (is shorter), it is padded with spaces. If the string has more characters than specified (is longer), then only the given number of characters is actually displayed. This function is especially useful if text messages can be displayed in different languages (and will naturally differ in length), but only a certain number of characters can be displayed.

#### Related topics

- [GUI\\_DispString](#) on page 228
- [GUI\\_DispStringAt](#) on page 229
- [GUI\\_DispStringAtCEOL](#) on page 230



#### 5.1.4.1.14 GUI\_GetCharFromPos()

##### Description

Returns a character from a string at a given X-position in the current font.

##### Prototype

```
U16 GUI_GetCharFromPos(const char * pText ,  
                       int      x ,  
                       int      * pIndex);
```

##### Parameters

| Parameter           | Description   |
|---------------------|---|
| <code>pText</code>  | Pointer to a string.  |
| <code>x</code>      | X-position in pixels in the string.   |
| <code>pIndex</code> | Pointer to int. Zero-based position of the character in the string. Can be <code>NULL</code> if not needed. |

##### Return value

= 0      No character found.  
≠ 0      Character at the given X-position in a string.

##### Additional information

The function assumes the text begins at `x = 0`. Notice also that a font has to have been set that contains the characters in the given string.

#### 5.1.4.1.15 GUI\_GetShowMissingCharacters()

##### Description

Returns if showing of missing characters is enabled or not.

##### Prototype

```
int GUI_GetShowMissingCharacters(void);
```

##### Return value

- 1        If enabled.
- 0        If not enabled.

### 5.1.4.1.16 GUI\_ShowMissingCharacters()

#### Description

This function enables displaying of missing characters.

#### Prototype

```
void GUI_ShowMissingCharacters(int OnOff);
```

#### Parameters

| Parameter | Description   |
|-----------|---|
| OnOff     | Enables (1) or disables (0) displaying of missing characters. |

#### Additional information

If a font does not contain a character to be displayed emWin skips this character. By calling this function a square gets displayed instead of the missing character.

### 5.1.4.1.17 GUI\_WrapGetNumLines()

#### Description

Returns the number of lines required to display the given text with the given wrap mode at the given size using the current font.

#### Prototype

```
int GUI_WrapGetNumLines(const char * pText,
                        int xSize,
                        GUI_WRAPMODE WrapMode);
```

#### Parameters

| Parameter             | Description   |
|-----------------------|---|
| <code>pText</code>    | String to display. Should be a \0-terminated array of 8-bit characters. |
| <code>xSize</code>    | X-size to be used to draw the text.                                     |
| <code>WrapMode</code> | See table below.  |

#### Return value

The number of lines which is required to display the given text.

## 5.1.4.2 Drawing modes

### 5.1.4.2.1 GUI\_GetTextMode()

#### Description

Returns the currently selected text mode.

#### Prototype

```
int GUI_GetTextMode(void);
```

#### Return value

The currently selected text mode.

### 5.1.4.2.2 GUI\_SetClearTextRectMode()

#### Description

Enables or disables the clear text rect mode.

#### Prototype

```
U8 GUI_SetClearTextRectMode(unsigned OnOff);
```

#### Parameters

| Parameter | Description                                  |
|-----------|--|
| OnOff     | Enables or disable the clear text rect mode. |

#### Return value

The previous selected mode.

#### Additional information

If the clear text rect mode is enabled the rectangular area when using `GUI_DispStringInRect()` gets cleared with the given background color.

### 5.1.4.2.3 GUI\_SetTextMode()

#### Description

Sets the text mode to the parameter specified.

#### Prototype

```
int GUI_SetTextMode(int Mode);
```

#### Parameters

| Parameter | Description   |
|-----------|---|
| Mode      | Text mode. See full list of available values under <i>Text drawing modes</i> on page 253. |

#### Return value

The previous selected text mode.

#### Additional information

Please note that GUI\_TM\_XOR can not be used with antialiased fonts.

#### 5.1.4.2.4 GUI\_SetTextStyle()

##### Description

Sets the text style to the parameter specified.

##### Prototype

```
char GUI_SetTextStyle(char Style);
```

##### Parameters

| Parameter          | Description   |
|--------------------|---|
| <code>Style</code> | Text style to set. See full list of available values under <i>Text style flags</i> on page 255. |

##### Return value

The previous selected text style.



### 5.1.4.3 Alignment

#### 5.1.4.3.1 GUI\_GetTextAlign()

##### Description

Returns the current text alignment mode.

##### Prototype

```
int GUI_GetTextAlign(void);
```

##### Return value

The current text alignment mode.

### 5.1.4.3.2 GUI\_SetLBorder()

#### Description

Sets the left border for line feeds in the current window.

#### Prototype

```
int GUI_SetLBorder(int x);
```

#### Parameters

| Parameter      | Description                                    |
|----------------|--|
| <code>x</code> | New left border (in pixels, 0 is left border). |

### 5.1.4.3.3 GUI\_SetTextAlign()

#### Description

Sets the text alignment for the next displayed string in the current window.

#### Prototype

```
int GUI_SetTextAlign(int Align);
```

#### Parameters

| Parameter              | Description   |
|------------------------|---|
| <code>TextAlign</code> | Text alignment mode to set. List of flags can be found under <i>Text alignment flags</i> on page 252. |

#### Return value

The selected text alignment mode.

#### Additional information

Setting the text alignment does not affect `GUI_DispChar...()`-functions. Text alignment is valid only for the current window.

#### Example

Displays the value 1234 with the center of the text at  $x = 100$ ,  $y = 100$ :

```
GUI_SetTextAlign(GUI_TA_HCENTER | GUI_TA_VCENTER);  
GUI_DispDecAt(1234, 100, 100, 4);
```

## 5.1.4.4 Position

### 5.1.4.4.1 GUI\_DispNextLine()

#### Description

Moves the cursor to the beginning of the next line which can be adjusted using the function `GUI_SetLBorder()`.

#### Prototype

```
void GUI_DispNextLine(void);
```

#### 5.1.4.4.2 GUI\_GotoXY()

#### 5.1.4.4.3 GUI\_GotoX()

#### 5.1.4.4.4 GUI\_GotoY()

### Description

Set the current text write position.

### Prototypes

```
char GUI_GotoXY(int x,  
               int y);
```

```
char GUI_GotoX(int x);
```

```
char GUI_GotoY(int y);
```

### Parameters

| Parameter | Description                                  |
|-----------|--|
| y         | New Y-position (in pixels, 0 is top border). |

### Return value

= 0 on success.

≠ 0 if the set text position is right or below outside the window. Consecutive drawing operations can be omitted in this case.

### Example

Shows a string at position (20, 20) on the display:

```
GUI_GotoXY(20,20);  
GUI_DispString("The value is");
```

#### 5.1.4.4.5 GUI\_GetDispPosX()

##### Description

Returns the current X-position.

##### Prototype

```
int GUI_GetDispPosX(void);
```

##### Return value

The current X-position.

#### 5.1.4.4.6 GUI\_GetDispPosY()

##### Description

Returns the current Y-position.

##### Prototype

```
int GUI_GetDispPosY(void);
```

##### Return value

The current Y-position.

## 5.1.4.5 Defines

### 5.1.4.5.1 Text alignment flags

#### Description

Define the alignment of a text. Horizontal and vertical flags are OR-combinable.

#### Definition

```
#define GUI_TA_LEFT      (0)
#define GUI_TA_HCENTER  (2 << 0)
#define GUI_TA_RIGHT    (1 << 0)
#define GUI_TA_TOP      (0)
#define GUI_TA_VCENTER  (3 << 2)
#define GUI_TA_BOTTOM   (1 << 2)
```

#### Symbols

| Definition                     | Description  |
|--------------------------------|--|
| Horizontal alignment           |  |
| <a href="#">GUI_TA_LEFT</a>    | Align X-position left (default).                   |
| <a href="#">GUI_TA_HCENTER</a> | Center X-position.                                 |
| <a href="#">GUI_TA_RIGHT</a>   | Align X-position right.                            |
| Vertical alignment             |  |
| <a href="#">GUI_TA_TOP</a>     | Align Y-position with top of characters (default). |
| <a href="#">GUI_TA_VCENTER</a> | Center Y-position.                                 |
| <a href="#">GUI_TA_BOTTOM</a>  | Align Y-position with bottom pixel line of font.   |



### 5.1.4.5.2 Text drawing modes

#### Description

These flags define with which mode a text will be drawn. These flags are OR-combinable.

#### Definition

```
#define GUI_TM_NORMAL      (0)
#define GUI_TM_XOR        (1 << 0)
#define GUI_TM_TRANS      (1 << 1)
#define GUI_TM_REV        (1 << 2)
```

#### Symbols

| Definition                    | Description  |
|-------------------------------|--|
| <a href="#">GUI_TM_NORMAL</a> | Default mode, characters are displayed using the foreground color, background color is used to clear the background according to width and height of the text. |
| <a href="#">GUI_TM_XOR</a>    | Characters are displayed using the inverted colors of the background (pixel-wise).   |
| <a href="#">GUI_TM_TRANS</a>  | Characters are displayed without the background being cleared.   |
| <a href="#">GUI_TM_REV</a>    | Characters are displayed using the background color, foreground color is used to clear the background according to width and height of the text.               |

#### Additional information

More information about text drawing modes can be found under Drawing modes.

### 5.1.4.5.3 Text rotation modes

#### Description

These macros are necessary for text rotation. They are used for example by the function `GUI_DispStringInRectEx()`.

#### Definition

```
#define GUI_ROTATE_0      0
#define GUI_ROTATE_180   &LCD_APIList180
#define GUI_ROTATE_CW    &LCD_APIListCW
#define GUI_ROTATE_CCW   &LCD_APIListCCW
```

#### Symbols

| Definition                     | Description  |
|--------------------------------|--|
| <a href="#">GUI_ROTATE_0</a>   | Does not rotate the text. Shows it from left to right. |
| <a href="#">GUI_ROTATE_180</a> | Rotates the text by 180 degrees.                       |
| <a href="#">GUI_ROTATE_CW</a>  | Rotates the text clockwise.                            |
| <a href="#">GUI_ROTATE_CCW</a> | Rotates the text counter clockwise.                    |

#### 5.1.4.5.4 Text style flags

##### Description

Text style how a text will be displayed.

##### Definition

```
#define GUI_TS_NORMAL          (0)
#define GUI_TS_UNDERLINE     (1 << 0)
#define GUI_TS_STRIKETHRU    (1 << 1)
#define GUI_TS_OVERLINE      (1 << 2)
```

##### Symbols

| Definition                        | Description                          |
|-----------------------------------|--------------------------------------|
| <a href="#">GUI_TS_NORMAL</a>     | Renders text normal (default).       |
| <a href="#">GUI_TS_UNDERLINE</a>  | Renders text underlined.             |
| <a href="#">GUI_TS_STRIKETHRU</a> | Renders text in strike through type. |
| <a href="#">GUI_TS_OVERLINE</a>   | Renders text in overline type.       |

## 5.1.4.6 Enumerations

### 5.1.4.6.1 GUI\_WRAPMODE

#### Description

Configuration how text will be wrapped.

#### Type definition

```
typedef enum {  
    GUI_WRAPMODE_NONE,  
    GUI_WRAPMODE_WORD,  
    GUI_WRAPMODE_CHAR  
} GUI_WRAPMODE;
```

#### Enumeration constants

| Constant                          | Description                    |
|-----------------------------------|--------------------------------|
| <a href="#">GUI_WRAPMODE_NONE</a> | No wrapping will be performed. |
| <a href="#">GUI_WRAPMODE_WORD</a> | Text is wrapped word wise.     |
| <a href="#">GUI_WRAPMODE_CHAR</a> | Text is wrapped char wise.     |

#### Additional information

If word wrapping should be performed and the given rectangle is too small for a word, char wrapping is executed at this word.

## 5.2 Displaying Values

The preceding chapter explained how to show strings on the display. Of course you may use strings and the functions of the standard C library to display values. However, this can sometimes be a difficult task. It is usually much easier (and much more efficient) to call a routine that displays the value in the form that you want. emWin supports different decimal, hexadecimal and binary outputs. The individual routines are explained in this chapter.

All functions work without the usage of a floating-point library and are optimized for both speed and size. Of course `sprintf()` may also be used on any system. Using the routines in this chapter can sometimes simplify things and save both ROM space and execution time.

## 5.2.1 Value API

The table below lists the available value-related routines in alphabetical order within their respective categories. Detailed descriptions of the routines can be found in the sections that follow.

| Routine                             | Description   |
|-------------------------------------|---|
| Displaying decimal values           |   |
| <code>GUI_DisDec()</code>           | Displays the given value in decimal form with the specified number of characters.   |
| <code>GUI_DisDecAt()</code>         | Displays the given value in decimal form at the specified position with specified number of characters.                   |
| <code>GUI_DisDecMin()</code>        | Displays the given value in decimal form with minimum number of characters.   |
| <code>GUI_DisDecShift()</code>      | Displays long value in decimal form with decimal point at current position with specified number of characters.           |
| <code>GUI_DisDecSpace()</code>      | Display value in decimal form at current position with specified number of characters, replace leading zeros with spaces. |
| <code>GUI_DisDecSign()</code>       | Display value in decimal form at current position with specified number of characters and sign.                           |
| <code>GUI_DisDecShiftSign()</code>  | Display long value in decimal form with decimal point at current position with specified number of characters and sign.   |
| Displaying floating-point values    |   |
| <code>GUI_DisFloat()</code>         | Display floating-point value with specified number of characters.   |
| <code>GUI_DisFloatFix()</code>      | Display floating-point value with fixed no. of digits to the right of decimal point.                                      |
| <code>GUI_DisFloatMin()</code>      | Display floating-point value with minimum number of characters.   |
| <code>GUI_DisFloatFixSign()</code>  | Display floating-point value with fixed no. of digits to the right of decimal point and sign.                             |
| <code>GUI_DisFloatMinSign()</code>  | Display floating-point value with minimum number of characters and sign.  |
| Displaying binary values            |   |
| <code>GUI_DisBin()</code>           | Display value in binary form at current position.   |
| <code>GUI_DisBinAt()</code>         | Display value in binary form at specified position.   |
| Displaying hexadecimal values       |   |
| <code>GUI_DisHex()</code>           | Display value in hexadecimal form at current position.  |
| <code>GUI_DisHexAt()</code>         | Display value in hexadecimal form at specified position.  |
| Version of emWin                    |   |
| <code>GUI_GetVersionString()</code> | Returns a string containing the current version of emWin.   |

## 5.2.1.1 Displaying decimal values

### 5.2.1.1.1 GUI\_DispDec()

#### Description

Displays a value in decimal form with a specified number of characters at the current text position, in the current window using the current font.

#### Prototype

```
void GUI_DispDec(I32 v,
                U8 Len);
```

#### Parameters

| Parameter        | Description   |
|------------------|---|
| <code>v</code>   | Value to display.<br>Minimum -2147483648 (= $-2^{31}$ ).<br>Maximum 2147483647 (= $2^{31} - 1$ ). |
| <code>Len</code> | Number of digits to display (max. 10).  |

#### Additional information

Leading zeros are not suppressed (are shown as 0). If the value is negative, a minus sign is shown.

#### Example

```
// Display time as minutes and seconds
GUI_DispString("Min:");
GUI_DispDec(Min, 2);
GUI_DispString(" Sec:");
GUI_DispDec(Sec, 2);
```

#### Related topics

- *GUI\_DispSDec* on page 264
- *GUI\_DispDecAt* on page 260
- *GUI\_DispDecMin* on page 261
- *GUI\_DispDecSpace* on page 263

### 5.2.1.1.2 GUI\_DisDecAt()

#### Description

Displays a value in decimal form with a specified number of characters at a specified position, in the current window using the current font.

#### Prototype

```
void GUI_DisDecAt(I32 v,
                 I16P x,
                 I16P y,
                 U8 Len);
```

#### Parameters

| Parameter        | Description   |
|------------------|---|
| <code>v</code>   | Value to display.<br>Minimum -2147483648 (= $-2^{31}$ ).<br>Maximum 2147483647 (= $2^{31} - 1$ ). |
| <code>x</code>   | X-position to write to in pixels of the client window.  |
| <code>y</code>   | Y-position to write to in pixels of the client window.  |
| <code>Len</code> | Number of digits to display (max. 10).  |

#### Additional information

Leading zeros are not suppressed (are shown as 0). If the value is negative, a minus sign is shown.

#### Example

```
// Update seconds in upper right corner
GUI_DisDecAT(Sec, 200, 0, 2);
```

#### Related topics

- *GUI\_DisDec* on page 259
- *GUI\_DisDecSpace* on page 263
- *GUI\_DisDecMin* on page 261
- *GUI\_DisDec* on page 259



### 5.2.1.1.3 GUI\_DisDecMin()

#### Description

Displays a value in decimal form at the current text position in the current window using the current font. The length of the value does not require to be specified. The minimum length will automatically be used.

#### Prototype

```
void GUI_DisDecMin(I32 v);
```

#### Parameters

| Parameter | Description   |
|-----------|---|
| v         | Value to display.<br>Minimum -2147483648 (= $-2^{31}$ ).<br>Maximum 2147483647 (= $2^{31} - 1$ ). |

#### Additional information

The maximum number of displayed digits is 10. This function should not be used if values have to be aligned but differ in the number of digits. Try one of the functions which require specification of the number of digits to use in this case.

#### Example

```
// Show result
GUI_DisString("The result is :");
GUI_DisDecMin(Result);
```

#### Related topics

- *GUI\_DisDec* on page 259
- *GUI\_DisDecAt* on page 260
- *GUI\_DisSDec* on page 264
- *GUI\_DisDecSpace* on page 263

#### 5.2.1.1.4 GUI\_DisDecShift()

##### Description

Displays a long value in decimal form with a specified number of characters and with decimal point at the current text position, in the current window using the current font.

##### Prototype

```
void GUI_DisDecShift(I32 v,  
                    U8 Len,  
                    U8 Shift);
```

##### Parameters

| Parameter          | Description   |
|--------------------|---|
| <code>v</code>     | Value to display.<br>Minimum -2147483648 (= $-2^{31}$ ).<br>Maximum 2147483647 (= $2^{31} - 1$ ). |
| <code>Len</code>   | Number of digits to display (max. 10).  |
| <code>Shift</code> | Number of digits to show to right of decimal point.   |

##### Additional information

Watch the maximum number of 9 characters (including sign and decimal point).

### 5.2.1.1.5 GUI\_DisDecSpace()

#### Description

Displays a long value in decimal form with a specified number of characters and with decimal point at the current text position, in the current window using the current font.

#### Prototype

```
void GUI_DisDecSpace(I32 v,
                    U8 MaxDigits);
```

#### Parameters

| Parameter              | Description   |
|------------------------|---|
| <code>v</code>         | Value to display. Minimum -2147483648 (= $-2^{31}$ ). Maximum 2147483647 (= $2^{31} - 1$ ).                                 |
| <code>MaxDigits</code> | Number of digits to display, including leading spaces. Maximum number of digits displayed is 10 (excluding leading spaces). |

#### Additional information

If values have to be aligned but differ in the number of digits, this function is a good choice.

#### Example

```
// Show result
GUI_DisString("The result is :");
GUI_DisDecSpace(Result, 200);
```

#### Related topics

- [GUI\\_DisDec](#) on page 259
- [GUI\\_DisDecAt](#) on page 260
- [GUI\\_DisDecS](#) on page 264
- [GUI\\_DisDecMin](#) on page 261

### 5.2.1.1.6 GUI\_DispsDec()

#### Description

Displays a value in decimal form (with sign) with a specified number of characters at the current text position, in the current window using the current font.

#### Prototype

```
void GUI_DispsDec(I32 v,  
                 U8 Len);
```

#### Parameters

| Parameter           | Description   |
|---------------------|---|
| <a href="#">v</a>   | Value to display. Minimum -2147483648 (= $-2^{31}$ ). Maximum 2147483647 (= $2^{31} - 1$ ). |
| <a href="#">Len</a> | Number of digits to display (max. 10).  |

#### Additional information

Leading zeros are not suppressed. This function is similar to `GUI_DispsDec`, but a sign is always shown in front of the value, even if the value is positive.

#### Related topics

- [GUI\\_DispsDec](#) on page 259
- [GUI\\_DispsDecAt](#) on page 260
- [GUI\\_DispsDecMin](#) on page 261
- [GUI\\_DispsDecSpace](#) on page 263

### 5.2.1.1.7 GUI\_DispsDecShift()

#### Description

Displays a long value in decimal form (with sign) with a specified number of characters and with decimal point at the current text position, in the current window using the current font.

#### Prototype

```
void GUI_DispsDecShift(I32 v,
                      U8 Len,
                      U8 Shift);
```

#### Parameters

| Parameter          | Description   |
|--------------------|---|
| <code>v</code>     | Value to display.<br>Minimum -2147483648 (= $-2^{31}$ ).<br>Maximum 2147483647 (= $2^{31} - 1$ ).             |
| <code>Len</code>   | Number of digits to display. (max. 8, if <code>Shift</code> is set; max. 9, if <code>Shift</code> is not set) |
| <code>Shift</code> | Number of digits to show to right of decimal point.   |

#### Additional information

A sign is always shown in front of the value. Watch the maximum number of 9 characters (including sign and decimal point).

#### Example

```
long Value = 12345;

GUI_Init();
GUI_Clear();
GUI_SetFont(&GUI_Font8x8);
GUI_DispsStringAt("GUI_DispsDecShift:\n",0,0);
GUI_DispsDecShift(Value, 7, 3);
```

#### Screenshot of above example



```
GUI_DispsDecShift:
+12.345
```

## 5.2.1.2 Displaying floating point values

### 5.2.1.2.1 GUI\_DispFloat()

#### Description

Displays a floating point value with a specified number of characters at the current text position in the current window using the current font.

#### Prototype

```
void GUI_DispFloat(    float f,
                    char Len);
```

#### Parameters

| Parameter        | Description   |
|------------------|---|
| <code>v</code>   | Value to display.<br>Minimum 1.2 E-38; maximum 3.4 E38. |
| <code>Len</code> | Number of digits to display. (max. 10).                 |

#### Additional information

Leading zeros are suppressed. The decimal point counts as one character. If the value is negative, a minus sign is shown.

#### Example

```
// Shows different possibilities to display floating point values.
float f = 123.45678;

GUI_Clear();
GUI_SetFont(&GUI_Font8x8);
GUI_DispStringAt("GUI_DispFloat:\n", 0, 0);
GUI_DispFloat(f, 9);
GUI_GotoX(100);
GUI_DispFloat(-f, 9);
GUI_DispStringAt("GUI_DispFloatFix:\n", 0, 20);
GUI_DispFloatFix(f, 9, 2);
GUI_GotoX(100);
GUI_DispFloatFix(-f, 9, 2);
GUI_DispStringAt("GUI_DispSFloatFix:\n", 0, 40);
GUI_DispSFloatFix(f, 9, 2);
GUI_GotoX(100);
GUI_DispSFloatFix(-f, 9, 2);
GUI_DispStringAt("GUI_DispFloatMin:\n", 0, 60);
GUI_DispFloatMin(f, 3);
GUI_GotoX(100);
GUI_DispFloatMin(-f, 3);
GUI_DispStringAt("GUI_DispSFloatMin:\n", 0, 80);
GUI_DispSFloatMin(f, 3);
GUI_GotoX(100);
GUI_DispSFloatMin(-f, 3);
```

**Screenshot of above example**

```
GUI_DisFloat:  
123.45678      -123.4568  
GUI_DisFloatFix:  
000123.46     -00123.46  
GUI_DisSFloatFix:  
+00123.46     -00123.46  
GUI_DisFloatMin:  
123.457       -123.457  
GUI_DisSFloatMin:  
+123.457     -123.457
```

### 5.2.1.2.2 GUI\_DisFloatFix()

#### Description

Displays a floating-point value with specified number of total characters and a specified number of characters to the right of the decimal point, at the current text position in the current window using the current font.

#### Prototype

```
void GUI_DisFloatFix(    float f,  
                       char Len,  
                       char Decs);
```

#### Parameters

| Parameter         | Description   |
|-------------------|---|
| <code>v</code>    | Value to display.<br>Minimum 1.2 E-38; maximum 3.4 E38.     |
| <code>Len</code>  | Number of digits to display. (max. 10).                     |
| <code>Decs</code> | Number of digits to show to the right of the decimal point. |

#### Additional information

Leading zeros are not suppressed. If the value is negative, a minus sign is shown.



### 5.2.1.2.3 GUI\_DisFloatMin()

#### Description

Displays a floating-point value with a minimum number of decimals to the right of the decimal point, at the current text position in the current window using the current font.

#### Prototype

```
void GUI_DisFloatMin(    float f,  
                       char Fract);
```

#### Parameters

| Parameter          | Description   |
|--------------------|---|
| <code>v</code>     | Value to display.<br>Minimum 1.2 E-38; maximum 3.4 E38. |
| <code>Fract</code> | Minimum number of characters to display.                |

#### Additional information

Leading zeros are suppressed. If the value is negative, a minus sign is shown. The length does not need to be specified. The minimum length will automatically be used. If values have to be aligned but differ in the number of digits, one of the "...Fix()" -functions should be used instead.

### 5.2.1.2.4 GUI\_DispsFloatFix()

#### Description

Displays a floating-point value (with sign) with a specified number of total characters and a specified number of characters to the right of the decimal point, in the current window using the current font.

#### Prototype

```
void GUI_DispsFloatFix(    float f,  
                          char Len,  
                          char Fract);
```

#### Parameters

| Parameter         | Description   |
|-------------------|---|
| <code>v</code>    | Value to display.<br>Minimum 1.2 E-38; maximum 3.4 E38.     |
| <code>Len</code>  | Number of digits to display (max. 10).                      |
| <code>Decs</code> | Number of digits to show to the right of the decimal point. |

#### Additional information

Leading zeros are not suppressed. A sign is always shown in front of the value.

### 5.2.1.2.5 GUI\_DispsFloatMin()

#### Description

Displays a floating-point value (with sign) with a minimum number of decimals to the right of the decimal point, at the current text position in the current window using the current font.

#### Prototype

```
void GUI_DispsFloatMin(    float f,  
                        char Fract);
```

#### Parameters

| Parameter          | Description   |
|--------------------|---|
| <code>v</code>     | Value to display.<br>Minimum 1.2 E-38; maximum 3.4 E38. |
| <code>Fract</code> | Minimum number of digits to display.                    |

#### Additional information

Leading zeros are suppressed. A sign is always shown in front of the value. The length does not need to be specified. The minimum length will automatically be used. If values have to be aligned but differ in the number of digits, one of the "...Fix()" -functions should be used instead.

## 5.2.1.3 Displaying binary values

### 5.2.1.3.1 GUI\_DispBin()

#### Description

Displays a value in binary form at the current text position in the current window using the current font.

#### Prototype

```
void GUI_DispBin(U32 v,  
                U8 Len);
```

#### Parameters

| Parameter        | Description  |
|------------------|--|
| <code>v</code>   | Value to display, 32-bit.                              |
| <code>Len</code> | Number of digits to display (including leading zeros). |

#### Additional information

As with decimal and hexadecimal values, the least significant bit is rightmost.

#### Example

```
//  
// Show binary value 7, result: 000111  
//  
U32 Input = 0x7;  
GUI_DispBin(Input, 6);
```

#### Related topics

*GUI\_DispBinAt* on page 273

### 5.2.1.3.2 GUI\_DispBinAt()

#### Description

Displays a value in binary form at a specified position in the current window using the current font.

#### Prototype

```
void GUI_DispBinAt(U32 v,  
                  I16P x,  
                  I16P y,  
                  U8 Len);
```

#### Parameters

| Parameter           | Description  |
|---------------------|--|
| <a href="#">v</a>   | Value to display, 32-bit.                              |
| <a href="#">x</a>   | X-position to write to in pixels of the client window. |
| <a href="#">y</a>   | Y-position to write to in pixels of the client window. |
| <a href="#">Len</a> | Number of digits to display (including leading zeros). |

#### Additional information

As with decimal and hexadecimal values, the least significant bit is rightmost.

#### Example

```
//  
// Show binary input status  
//  
GUI_DispBinAt(Input, 0, 0, 8);
```

#### Related topics

- [GUI\\_DispBin](#) on page 272
- [GUI\\_DispHex](#) on page 274

## 5.2.1.4 Displaying hexadecimal values

### 5.2.1.4.1 GUI\_DispHex()

#### Description

Displays a value in hexadecimal form at the current text position in the current window using the current font.

#### Prototype

```
void GUI_DispHex(U32 v,  
                 U8 Len);
```

#### Parameters

| Parameter        | Description                  |
|------------------|------------------------------|
| <code>v</code>   | Value to display, 32-bit.    |
| <code>Len</code> | Number of digits to display. |

#### Additional information

As with decimal and binary values, the least significant bit is rightmost.

#### Example

```
//  
// Show value of AD-converter  
//  
GUI_DispHex(Input, 4);
```

#### Related topics

- *GUI\_DispDec* on page 259
- *GUI\_DispBin* on page 272
- *GUI\_DispHexAt* on page 275

### 5.2.1.4.2 GUI\_DispatchHexAt()

#### Description

Displays a value in hexadecimal form at a specified position in the current window using the current font.

#### Prototype

```
void GUI_DispatchHexAt(U32 v,  
                      I16P x,  
                      I16P y,  
                      U8 Len);
```

#### Parameters

| Parameter        | Description  |
|------------------|--|
| <code>v</code>   | Value to display, 32-bit.                              |
| <code>x</code>   | X-position to write to in pixels of the client window. |
| <code>y</code>   | Y-position to write to in pixels of the client window. |
| <code>Len</code> | Number of digits to display.                           |

#### Additional information

As with decimal and binary values, the least significant bit is rightmost.

#### Example

```
//  
// Show value of AD-converter at specified position  
//  
GUI_DispatchHexAt(Input, 0, 0, 4);
```

#### Related topics

- *GUI\_DispatchDec* on page 259
- *GUI\_DispatchBin* on page 272
- *GUI\_DispatchHexAt* on page 275

### 5.2.1.5 GUI\_GetVersionString()

#### Description

Returns a string containing the current version of emWin.

#### Prototype

```
char *GUI_GetVersionString(void);
```

#### Return value

Returns a pointer to an array of chars containing the current emWin version.

#### Example

```
//  
// Displays the current version at the current cursor position  
//  
GUI_DisString(GUI_GetVersionString());
```



## 5.3 2-D Graphic Library

emWin contains a complete 2-D graphic library which should be sufficient for most applications. The routines supplied with emWin can be used with or without clipping (refer to the chapter *The Window Manager (WM)* on page 798) and are based on fast and efficient algorithms. Currently, only the `GUI_DrawArc()` function requires floating-point calculations.

### 5.3.1 Graphic API

The table below lists the available graphic-related routines in alphabetical order within their respective categories. Detailed descriptions can be found in the sections that follow.

#### Functions

| Routine                                   | Description  |
|---|--|
| Drawing related functions                 |  |
| <code>GUI_AddRect()</code>                | This function resizes the given rectangle.   |
| <code>GUI_GetClientRect()</code>          | Returns the current available drawing area.  |
| <code>GUI_GetClipRect()</code>            | Returns the currently set clip rectangle.  |
| <code>GUI_GetDrawMode()</code>            | Returns the current drawing mode.  |
| <code>GUI_GetPenSize()</code>             | Returns the current pen size.  |
| <code>GUI_GetPixelIndex()</code>          | Returns the color index of a given position.   |
| <code>GUI_SetClipRect()</code>            | Sets the rectangle used for clipping.  |
| <code>GUI_SetDrawMode()</code>            | Selects the specified drawing mode.  |
| <code>GUI_SetPenSize()</code>             | Sets the pen size in pixels.   |
| Basic drawing routines                    |  |
| <code>GUI_Clear()</code>                  | Fills the display/the active window with the background color.   |
| <code>GUI_ClearRect()</code>              | Fills a rectangular area with the background color.  |
| <code>GUI_CopyRect()</code>               | Copies a rectangle area on the display.  |
| <code>GUI_DrawFrame()</code>              | Draws a frame of the given size within the specified area.   |
| <code>GUI_DrawFrameEx()</code>            | Draws a frame in the current window at the position specified in the rectangle passed to the function. |
| <code>GUI_DrawGradientH()</code>          | Draws a rectangle filled with a horizontal color gradient.   |
| <code>GUI_DrawGradientHEx()</code>        | Draws a horizontal color gradient from a <code>GUI_RECT</code> pointer.                                |
| <code>GUI_DrawGradientV()</code>          | Draws a rectangle filled with a vertical color gradient.   |
| <code>GUI_DrawGradientVEx()</code>        | Draws a vertical color gradient from a <code>GUI_RECT</code> pointer.                                  |
| <code>GUI_DrawGradientRoundedH()</code>   | Draws a rectangle with rounded corners filled with a horizontal color gradient.                        |
| <code>GUI_DrawGradientRoundedHEx()</code> | Draws a rectangle with rounded corners filled with a horizontal color gradient.                        |

| Routine                                   | Description   |
|---|---|
| <code>GUI_DrawGradientRoundedV()</code>   | Draws a rectangle with rounded corners filled with a vertical color gradient.                   |
| <code>GUI_DrawGradientRoundedVEx()</code> | Draws a vertical color gradient with rounded corners from a <code>GUI_RECT</code> pointer.      |
| <code>GUI_DrawGradientMH()</code>         | Draws a rectangle filled with a horizontal multi color gradient.                                |
| <code>GUI_DrawGradientMHEx()</code>       | Draws a rectangle filled with a horizontal multi color gradient.                                |
| <code>GUI_DrawGradientMV()</code>         | Draws a rectangle filled with a vertical multi color gradient.                                  |
| <code>GUI_DrawGradientMVEx()</code>       | Draws a vertical multi color gradient from a <code>GUI_RECT</code> pointer.                     |
| <code>GUI_DrawPixel()</code>              | Draws a single pixel.   |
| <code>GUI_DrawPoint()</code>              | Draws a point.  |
| <code>GUI_DrawRect()</code>               | Draws a rectangle.  |
| <code>GUI_DrawRectEx()</code>             | Draws a rectangle from a <code>GUI_RECT</code> structure.                                       |
| <code>GUI_DrawRoundedFrame()</code>       | Draws a frame with rounded corners.   |
| <code>GUI_DrawRoundedFrameEx()</code>     | Draws a frame with rounded corners from a <code>GUI_RECT</code> structure.                      |
| <code>GUI_DrawRoundedRect()</code>        | Draws a rectangle with rounded corners.   |
| <code>GUI_DrawRoundedRectEx()</code>      | Draws a rectangle with rounded corners from a <code>GUI_RECT</code> structure.                  |
| <code>GUI_FillRect()</code>               | Draws a filled rectangle.   |
| <code>GUI_FillRectEx()</code>             | Draws a filled rectangle from a <code>GUI_RECT</code> structure.                                |
| <code>GUI_FillRoundedRect()</code>        | Draws a filled rectangle with rounded corners.  |
| <code>GUI_FillRoundedRectEx()</code>      | Draws a filled rectangle with rounded corners from a <code>GUI_RECT</code> structure.           |
| <code>GUI_InvertRect()</code>             | Invert a rectangular area.  |
| <b>Alpha blending</b>                     |   |
| <code>GUI_EnableAlpha()</code>            | Enables/disables automatic alpha blending.  |
| <code>GUI_PreserveTrans()</code>          | Makes sure that alpha channel remains after drawing operations.                                 |
| <code>GUI_RestoreUserAlpha()</code>       | Restores the previous state of user alpha blending  |
| <code>GUI_SetAlpha()</code>               | Sets the current alpha blending value. (Obsolete)   |
| <code>GUI_SetUserAlpha()</code>           | Sets an additional value which is used to calculate the actual alpha blending value to be used. |
| <b>Drawing bitmaps</b>                    |   |
| <code>GUI_DrawBitmap()</code>             | Draws a bitmap.   |
| <code>GUI_DrawBitmapEx()</code>           | Draws a scaled bitmap.  |
| <code>GUI_DrawBitmapMag()</code>          | Draws a magnified bitmap.   |

| Routine  | Description   |
|--|---|
| <code>GUI_SetAlphaMask8888()</code>                | Can be used for setting an additional AND and OR mask to be used for drawing the pixels of 32bpp bitmaps. |
| <b>Drawing streamed bitmaps</b>                    |   |
| <code>GUI_CreateBitmapFromStream()</code>          | Creates a bitmap from a given stream of any type.   |
| <code>GUI_CreateBitmapFromStreamIDX()</code>       | Creates a bitmap from an index based bitmap stream.   |
| <code>GUI_CreateBitmapFromStreamRLE1()</code>      | Creates a bitmap from an RLE1 bitmap stream.  |
| <code>GUI_CreateBitmapFromStreamRLE4()</code>      | Creates a bitmap from an RLE4 bitmap stream.  |
| <code>GUI_CreateBitmapFromStreamRLE8()</code>      | Creates a bitmap from an RLE8 bitmap stream.  |
| <code>GUI_CreateBitmapFromStream444_12()</code>    | Creates a bitmap from a 12bpp (444_12) bitmap stream.   |
| <code>GUI_CreateBitmapFromStream444_12_1()</code>  | Creates a bitmap from a 12bpp (444_12_1) bitmap stream.   |
| <code>GUI_CreateBitmapFromStreamM444_12()</code>   | Creates a bitmap from a 12bpp (M444_12) bitmap stream.  |
| <code>GUI_CreateBitmapFromStreamM444_12_1()</code> | Creates a bitmap from a 12bpp (M444_12_1) bitmap stream.  |
| <code>GUI_CreateBitmapFromStream444_16()</code>    | Creates a bitmap from a 12bpp (444_16) bitmap stream.   |
| <code>GUI_CreateBitmapFromStreamM444_16()</code>   | Creates a bitmap from a 12bpp (444_16_1) bitmap stream.   |
| <code>GUI_CreateBitmapFromStreamA555()</code>      | Creates a bitmap with an alpha channel from a 16bpp (A555) bitmap stream.                                 |
| <code>GUI_CreateBitmapFromStreamAM555()</code>     | Creates a bitmap with an alpha channel from a 16bpp (AM555) bitmap stream.                                |
| <code>GUI_CreateBitmapFromStreamA565()</code>      | Creates a bitmap with an alpha channel from a 16bpp (A565) bitmap stream.                                 |
| <code>GUI_CreateBitmapFromStreamAM565()</code>     | Creates a bitmap with an alpha channel from a 16bpp (AM565) bitmap stream.                                |
| <code>GUI_CreateBitmapFromStream565()</code>       | Creates a bitmap from a 16bpp (565) bitmap stream.  |
| <code>GUI_CreateBitmapFromStreamM565()</code>      | Creates a bitmap from a 16bpp (M565) bitmap stream with red and blue swapped.                             |
| <code>GUI_CreateBitmapFromStream555()</code>       | Creates a bitmap from a 16bpp (555) bitmap stream.  |
| <code>GUI_CreateBitmapFromStreamM555()</code>      | Creates a bitmap from a 16bpp (M555) bitmap stream with red and blue swapped.                             |
| <code>GUI_CreateBitmapFromStreamRLE16()</code>     | Creates a bitmap from an RLE16 (565) bitmap stream.   |
| <code>GUI_CreateBitmapFromStreamRLEM16()</code>    | Creates a bitmap from an RLEM16 (M565) bitmap stream with red and blue swapped.                           |
| <code>GUI_CreateBitmapFromStream24()</code>        | Creates a bitmap from a 24 bit bitmap stream.   |

| <b>Routine</b>                                    | <b>Description</b>   |
|---|--|
| <code>GUI_CreateBitmapFromStreamAlpha()</code>    | Creates a bitmap from a 32 bit bitmap stream.  |
| <code>GUI_CreateBitmapFromStreamRLEAlpha()</code> | Creates a bitmap from an RLE compressed 8 bit alpha bitmap stream.                                       |
| <code>GUI_CreateBitmapFromStreamRLE32()</code>    | Creates a bitmap from an RLE32 bitmap stream.  |
| <code>GUI_DrawStreamedBitmap()</code>             | Draws a bitmap from an indexed based bitmap stream (1 - 8bpp).   |
| <code>GUI_DrawStreamedBitmapAuto()</code>         | Draws a bitmap from a bitmap stream of any supported format.   |
| <code>GUI_DrawStreamedBitmapEx()</code>           | Draws a bitmap from an indexed based bitmap stream (1 - 8bpp) without loading the complete image.        |
| <code>GUI_DrawStreamedBitmapExAuto()</code>       | Draws a bitmap from a bitmap stream of any supported format without loading the complete image.          |
| <code>GUI_DrawStreamedBitmapA555Ex()</code>       | Draws a bitmap from a 16bpp (A555) bitmap stream with alpha channel without loading the complete image.  |
| <code>GUI_DrawStreamedBitmapAM555Ex()</code>      | Draws a bitmap from a 16bpp (AM555) bitmap stream with alpha channel without loading the complete image. |
| <code>GUI_DrawStreamedBitmapA565Ex()</code>       | Draws a bitmap from a 16bpp (AM565) bitmap stream with alpha channel without loading the complete image. |
| <code>GUI_DrawStreamedBitmapAM565Ex()</code>      | Draws a bitmap from a 16bpp (AM565) bitmap stream with alpha channel without loading the complete image. |
| <code>GUI_DrawStreamedBitmap555Ex()</code>        | Draws a bitmap from a 16bpp (555) bitmap stream without loading the complete image.                      |
| <code>GUI_DrawStreamedBitmapM555Ex()</code>       | Draws a bitmap from a 16bpp (M555) bitmap stream without loading the complete image.                     |
| <code>GUI_DrawStreamedBitmap565Ex()</code>        | Draws a bitmap from a 16bpp (565) bitmap stream without loading the complete image.                      |
| <code>GUI_DrawStreamedBitmapM565Ex()</code>       | Draws a bitmap from a 16bpp (M565) bitmap stream without loading the complete image.                     |
| <code>GUI_DrawStreamedBitmap24Ex()</code>         | Draws a bitmap from a 24bpp bitmap stream without loading the complete image.                            |
| <code>GUI_GetStreamedBitmapInfo()</code>          | Returns information about the given stream.  |
| <code>GUI_GetStreamedBitmapInfoEx()</code>        | Returns information about the given stream which can be located on any kind of media.                    |
| <code>GUI_SetStreamedBitmapHook()</code>          | Sets a hook function for <code>GUI_DrawStreamedBitmapEx()</code> .                                       |
| <b>Drawing lines</b>                              |  |
| <code>GUI_DrawHLine()</code>                      | Draws a horizontal line.   |

| Routine                             | Description   |
|-------------------------------------|---|
| <code>GUI_DrawLine()</code>         | Draws a line from a specified starting point to a specified endpoint in the current window (absolute coordinates).                                |
| <code>GUI_DrawLineRel()</code>      | Draws a line from the current (x, y) position to an endpoint specified by X-distance and Y-distance in the current window (relative coordinates). |
| <code>GUI_DrawLineTo()</code>       | Draws a line from the current position to a specified endpoint.   |
| <code>GUI_DrawPolyLine()</code>     | Draws a polyline.   |
| <code>GUI_DrawVLine()</code>        | Draws a vertical line.  |
| <code>GUI_GetLineStyle()</code>     | Returns the current line style used by the function <code>GUI_DrawLine</code> .   |
| <code>GUI_MoveRel()</code>          | Moves the current line pointer relative to its current position.  |
| <code>GUI_MoveTo()</code>           | Moves the current line pointer to the given position.   |
| <code>GUI_SetLineStyle()</code>     | Sets the current line style used by the function <code>GUI_DrawLine()</code> .  |
| <b>Drawing polygons</b>             |   |
| <code>GUI_DrawPolygon()</code>      | Draws the outline of a polygon.   |
| <code>GUI_EnlargePolygon()</code>   | Enlarges a polygon.   |
| <code>GUI_FillPolygon()</code>      | Draws a filled polygon.   |
| <code>GUI_MagnifyPolygon()</code>   | Magnifies a polygon by a specified factor.  |
| <code>GUI_RotatePolygon()</code>    | Rotates a polygon by a specified angle.   |
| <b>Drawing circles</b>              |   |
| <code>GUI_DrawCircle()</code>       | Draws the outline of a circle.  |
| <code>GUI_FillCircle()</code>       | Draws a filled circle.  |
| <b>Drawing ellipses</b>             |   |
| <code>GUI_DrawEllipse()</code>      | Draws the outline of an ellipse.  |
| <code>GUI_DrawEllipseXL()</code>    | Draws the outline of a large ellipse.   |
| <code>GUI_FillEllipse()</code>      | Draws a filled ellipse.   |
| <b>Drawing arcs</b>                 |   |
| <code>GUI_DrawArc()</code>          | Draws an arc.   |
| <code>GUI_DrawArcHR()</code>        | Draws an arc of specified dimensions at a specified position in the current window.   |
| <code>GUI_DrawArcHREx()</code>      | Draws an arc with optionally rounded ends.  |
| <b>Drawing a graph</b>              |   |
| <code>GUI_DrawGraph()</code>        | Draws a graph.  |
| <b>Drawing barcodes</b>             |   |
| <code>GUI_BARCODE_Draw()</code>     | Draws a barcode.  |
| <code>GUI_BARCODE_GetXSize()</code> | Returns the X-size of a given barcode without drawing it.   |
| <b>Drawing QR codes</b>             |   |

| <b>Routine</b>                              | <b>Description</b>  |
|---|---|
| <code>GUI_QR_Create()</code>                | Creates a QR-code bitmap.   |
| <code>GUI_QR_CreateFramed()</code>          | Creates a QR-code bitmap with a white frame around it.                                      |
| <code>GUI_QR_Delete()</code>                | Deletes a QR-code bitmap.   |
| <code>GUI_QR_Draw()</code>                  | Draws a QR-code bitmap.   |
| <code>GUI_QR_GetInfo()</code>               | Fills an information structure.   |
| <b>Drawing a pie chart</b>                  |   |
| <code>GUI_DrawPie()</code>                  | Draws a circle sector.  |
| <code>GUI_DrawPieHR()</code>                | Draws a circle sector.  |
| <b>Drawing a spline</b>                     |   |
| <code>GUI_SPLINE_Create()</code>            | Creates a spline.   |
| <code>GUI_SPLINE_Delete()</code>            | Deletes a spline.   |
| <code>GUI_SPLINE_Draw()</code>              | Draws a spline.   |
| <code>GUI_SPLINE_DrawAA()</code>            | Draw an anti aliased spline.  |
| <code>GUI_SPLINE_GetY()</code>              | Return the Y-value of a point.  |
| <code>GUI_SPLINE_GetXSize()</code>          | Returns the X-size of a spline.   |
| <b>Saving and restoring the GUI context</b> |   |
| <code>GUI_RestoreContext()</code>           | The function restores the GUI-context.  |
| <code>GUI_SaveContext()</code>              | The function saves the current GUI-context.   |
| <b>Info about screen changes</b>            |   |
| <code>GUI_DIRTYDEVICE_Create()</code>       | Creates a DIRTYDEVICE object.   |
| <code>GUI_DIRTYDEVICE_CreateEx()</code>     | Creates a DIRTYDEVICE object in the given layer.  |
| <code>GUI_DIRTYDEVICE_Delete()</code>       | Deletes a DIRTYDEVICE object.   |
| <code>GUI_DIRTYDEVICE_DeleteEx()</code>     | Deletes a DIRTYDEVICE object from the given layer.  |
| <code>GUI_DIRTYDEVICE_Fetch()</code>        | Fetches information from a DIRTYDEVICE.   |
| <code>GUI_DIRTYDEVICE_FetchEx()</code>      | Fetches information from a DIRTYDEVICE of the given layer.                                  |
| <b>YUV device</b>                           |   |
| <code>GUI_YUV_Create()</code>               | Creates a YUV device in the current layer.  |
| <code>GUI_YUV_CreateEx()</code>             | Creates a YUV device in the given layer with the given period.                              |
| <code>GUI_YUV_Delete()</code>               | Deletes the YUV device of the current layer.  |
| <code>GUI_YUV_DeleteEx()</code>             | Deletes the YUV device of the given layer.  |
| <code>GUI_YUV_GetpData()</code>             | Returns a pointer to the YUV plane of the current layer and the size of the plane in bytes. |
| <code>GUI_YUV_GetpDataEx()</code>           | Returns a pointer to the YUV plane of the given layer and the size of the plane in bytes.   |

| Routine                               | Description   |
|---------------------------------------|---|
| <code>GUI_YUV_InvalidateArea()</code> | Invalidates the given area of the current layer.  |
| <code>GUI_YUV_SetPeriod()</code>      | Sets the recalculation period of the YUV device in the current layer.   |
| <code>GUI_YUV_SetPeriodEx()</code>    | Sets the period to be used for (re)calculation.   |
| <b>Cache with color reducer</b>       |   |
| <code>GUI_GCACHE_4_Create()</code>    | Activates a global display cache with color reducer.  |
| <code>GUI_GCACHE_4_CreateEx()</code>  | Activates a global display cache with color reducer in the given layer.   |
| <b>Hook functions</b>                 |   |
| <code>GUI_SetAfterExitHook()</code>   | Sets an optional function to be called during the process of deinitialization.  |
| <code>GUI_SetAfterInitHook()</code>   | Sets an optional function to be called during the process of initialization.  |
| <code>GUI_SetControlHook()</code>     | Sets a function which is called immediately before a display driver cache operation should be executed.                 |
| <code>GUI_SetRefreshHook()</code>     | Sets a callback function which waits until the vertical non display period has been reached before updating the screen. |

## Data structures

| Structure                           | Description  |
|-------------------------------------|--|
| <code>GUI_ALPHA_STATE</code>        | Used for storing the alpha value with <code>GUI_SetUserAlpha()</code> .                            |
| <code>GUI_BITMAPSTREAM_INFO</code>  | Information about a streamed bitmap.   |
| <code>GUI_BITMAPSTREAM_PARAM</code> | Contains a command to be used by a set hook function for <code>GUI_DrawStreamedBitmapEx()</code> . |
| <code>GUI_DIRTYDEVICE_INFO</code>   | Information about the dirty device.  |
| <code>GUI_GRADIENT_INFO</code>      | Information used for drawing multi-color gradients.  |
| <code>GUI_POINT</code>              | Point on the screen.   |
| <code>GUI_QR_INFO</code>            | Information about a QR code.   |
| <code>GUI_RECT</code>               | Rectangle on the screen.   |

## Defines

| Group of defines                     | Description                                      |
|--------------------------------------|--|
| <code>Barcode types</code>           | Type of barcode to be drawn.                     |
| <code>Drawing modes</code>           | Mode to be used for drawing operations.          |
| <code>ECC levels for QR codes</code> | Error correction level to be used for a QR code. |
| <code>Line styles</code>             | Style how a line is drawn.                       |

## 5.3.1.1 Drawing related functions

### 5.3.1.1.1 GUI\_AddRect()

#### Description

This function resizes the given rectangle.

#### Prototype

```
void GUI_AddRect(      GUI_RECT * pDest,  
                     const GUI_RECT * pRect,  
                     int          Dist);
```

#### Parameters

| Parameter          | Description   |
|--------------------|---|
| <code>pDest</code> | Pointer to a rectangle where the modified rectangle gets stored in. |
| <code>pRect</code> | Pointer to the original rectangle.                                  |
| <code>Dist</code>  | Value to be added to the rect. If negative it gets subtracted.      |



### 5.3.1.1.2 GUI\_GetClientRect()

#### Description

The current client rectangle depends on using the Window Manager or not. If using the Window Manager the function uses `WM_GetClientRect` to retrieve the client rectangle. If not using the Window Manager the client rectangle corresponds to the complete LCD display.

#### Prototype

```
void GUI_GetClientRect(GUI_RECT * pRect);
```

#### Parameters

| Parameter          | Description   |
|--------------------|---|
| <code>pRect</code> | Pointer to the <code>GUI_RECT</code> -structure which is filled with the coordinates of the client rectangle. |

### 5.3.1.1.3 GUI\_GetClipRect()

#### Description

Returns the currently set clip rectangle.

#### Prototype

```
GUI_RECT *GUI_GetClipRect(void);
```

#### Return value

Pointer to the currently set clip rectangle.

#### 5.3.1.1.4 GUI\_GetDrawMode()

##### Description

Returns the current drawing mode.

##### Prototype

```
GUI_DRAWMODE GUI_GetDrawMode(void);
```

##### Return value

The currently selected drawing mode.

### 5.3.1.1.5 GUI\_GetPenSize()

#### Description

Returns the current pen size.

#### Prototype

```
U16 GUI_GetPenSize(void);
```

#### Return value

The current pen size.

### 5.3.1.1.6 GUI\_GetPixelIndex()

#### Description

Returns the color index of a given position.

#### Prototype

```
unsigned GUI_GetPixelIndex(int x,  
                           int y);
```

#### Parameters

| Parameter      | Description                                    |
|----------------|--|
| <code>x</code> | Absolute <code>x</code> -position of the pixel |
| <code>y</code> | Absolute <code>y</code> -position of the pixel |

#### Return value

The color index of the given position.

### 5.3.1.1.7 GUI\_SetClipRect()

#### Description

Sets the clipping rectangle used for limiting the output.

#### Prototype

```
GUI_RECT *GUI_SetClipRect(const GUI_RECT * pRect);
```

#### Parameters

| Parameter          | Description  |
|--------------------|--|
| <code>pRect</code> | Pointer to the rectangle which should be used for clipping. A <code>NULL</code> pointer should be used to restore the default value. |

#### Return value

Pointer to the old clipping rectangle.

#### Additional information

The clipping area is limited to the configured (virtual) display size per default. Under some circumstances it can be useful to use a smaller clipping rectangle, which can be set using this function. The rectangle referred to should remain unchanged until the function is called again with a `NULL` pointer.

#### Example

The following example shows how to use the function:

```
GUI_RECT Rect = {10, 10, 100, 100};
GUI_SetClipRect(&Rect);
.
. // Draw something...
.
GUI_SetClipRect(NULL);
```

### 5.3.1.1.8 GUI\_SetDrawMode()

#### Description

Selects the specified drawing mode.

#### Prototype

```
GUI_DRAWMODE GUI_SetDrawMode(GUI_DRAWMODE dm);
```

#### Parameters

| Parameter       | Description   |
|-----------------|---|
| <code>dm</code> | Drawing mode to set. Full list of permitted values can be found under <i>Drawing modes</i> on page 241. |

#### Return value

The previously set drawing mode.

#### Additional information

If using colors, an inverted pixel is calculated as follows:

#### Example

```
//  
// Showing two circles, the second one XOR-combined with the first:  
//  
GUI_Clear();  
GUI_SetDrawMode(GUI_DRAWMODE_NORMAL);  
GUI_FillCircle(120, 64, 40);  
GUI_SetDrawMode(GUI_DRAWMODE_XOR);  
GUI_FillCircle(140, 84, 40);
```

#### Screenshot of above example



### 5.3.1.1.9 GUI\_SetPenSize()

#### Description

Sets the pen size to be used for further drawing operations.

#### Prototype

```
U16 GUI_SetPenSize(U16 PenSize);
```

#### Parameters

| Parameter | Description                    |
|-----------|--------------------------------|
| PenSize   | Pen size in pixels to be used. |

#### Return value

Previous pen size.

#### Additional information

The pen size should be  $\geq 1$ . It is not possible to combine line styles with a pen size  $> 1$ .

The following vector drawing operations are affected by the pen size:

- GUI\_DrawPoint()
- GUI\_DrawLine()
- GUI\_DrawLineRel()
- GUI\_DrawLineTo()
- GUI\_DrawPolyLine()
- GUI\_DrawPolygon()
- GUI\_DrawEllipse()
- GUI\_DrawArc()
- GUI\_DrawRect()
- GUI\_DrawRectEx()



## 5.3.1.2 Basic drawing routines

The basic drawing routines allow drawing of individual points, horizontal and vertical lines and shapes at any position on the display. Any available drawing mode can be used. Since these routines are called frequently in most applications, they are optimized for speed as much as possible. For example, the horizontal and vertical line functions do not require the use of single-dot routines.

### 5.3.1.2.1 GUI\_Clear()

#### Description

Clears the current window.

#### Prototype

```
void GUI_Clear(void);
```

#### Additional information

If no window has been defined, the current window is the entire display. In this case, the entire display is cleared.

#### Example

```
GUI_DispStringAt("Hello world", 0, 0); // Display text.  
GUI_Delay(1000); // Wait 1 second.  
GUI_Clear(); // Clear screen.
```

### 5.3.1.2.2 GUI\_ClearRect()

#### Description

Clears a rectangular area at a specified position in the current window by filling it with the background color.

#### Prototype

```
void GUI_ClearRect(int x0,  
                  int y0,  
                  int x1,  
                  int y1);
```

#### Parameters

| Parameter          | Description             |
|--------------------|-------------------------|
| <a href="#">x0</a> | Upper left X-position.  |
| <a href="#">y0</a> | Upper left Y-position.  |
| <a href="#">x1</a> | Lower right X-position. |
| <a href="#">y1</a> | Lower right Y-position. |

#### Related topics

- [GUI\\_InvertRect](#) on page 320
- [GUI\\_FillRect](#) on page 316

### 5.3.1.2.3 GUI\_CopyRect()

#### Description

Copies the content of the given rectangular area to the specified position.

#### Prototype

```
void GUI_CopyRect (int x0,  
                  int y0,  
                  int x1,  
                  int y1,  
                  int xSize,  
                  int ySize);
```

#### Parameters

| Parameter | Description   |
|-----------|---|
| x0        | Upper left X-position of the source rectangle.      |
| y0        | Upper left Y-position of the source rectangle.      |
| x1        | Upper left X-position of the destination rectangle. |
| y1        | Upper left Y-position of the destination rectangle. |
| xSize     | X-size of the rectangle.                            |
| ySize     | Y-size of the rectangle.                            |

#### Additional information

The source and destination rectangle may overlap each other.

### 5.3.1.2.4 GUI\_DrawFrame()

#### Description

Draws a frame of the given size within the specified area.

The difference between `GUI_DrawRect()` and `GUI_DrawFrame()` is that if the rectangle to be drawn is thicker than 1 px

- `GUI_DrawRect()` will draw lines inside and outside of the rectangle to keep the drawn rectangle centered around the given position while
- `GUI_DrawFrame()` will draw lines only within the rectangle.

#### Prototype

```
void GUI_DrawFrame(int x0,  
                  int y0,  
                  int x1,  
                  int y1,  
                  int Size);
```

#### Parameters

| Parameter         | Description             |
|-------------------|-------------------------|
| <code>x0</code>   | Upper left X-position.  |
| <code>y0</code>   | Upper left Y-position.  |
| <code>x1</code>   | Lower right X-position. |
| <code>y1</code>   | Lower right Y-position. |
| <code>Size</code> | Width of the frame.     |

### 5.3.1.2.5 GUI\_DrawFrameEx()

#### Description

Draws a frame in the current window at the position specified in the rectangle passed to the function.

To learn about the difference between `GUI_DrawRect()` and `GUI_DrawFrame()`, see the description of `GUI_DrawFrame()`.

#### Prototype

```
void GUI_DrawFrameEx(const GUI_RECT * pRect,  
                    int           Size);
```

#### Parameters

| Parameter          | Description  |
|--------------------|--|
| <code>pRect</code> | Pointer to a <code>GUI_RECT</code> -structure containing the coordinates of the frame. |
| <code>Size</code>  | Width of the frame.  |

### 5.3.1.2.6 GUI\_DrawGradientH()

#### Description

Draws a rectangle filled with a horizontal color gradient.

#### Prototype

```
void GUI_DrawGradientH(int    x0,  
                      int    y0,  
                      int    x1,  
                      int    y1,  
                      GUI_COLOR Color0,  
                      GUI_COLOR Color1);
```

#### Parameters

| Parameter           | Description   |
|---------------------|---|
| <code>x0</code>     | Upper left X-position.                                    |
| <code>y0</code>     | Upper left Y-position.                                    |
| <code>x1</code>     | Lower right X-position.                                   |
| <code>y1</code>     | Lower right Y-position.                                   |
| <code>Color0</code> | Color to be drawn on the leftmost side of the rectangle.  |
| <code>Color1</code> | Color to be drawn on the rightmost side of the rectangle. |

#### Example

```
GUI_DrawGradientH(0, 0, 99, 99, 0x0000FF, 0x00FFFF);
```

#### Screenshot of above example



### 5.3.1.2.7 GUI\_DrawGradientHEX()

#### Description

Draws a horizontal color gradient from a GUI\_RECT pointer.

#### Prototype

```
void GUI_DrawGradientHEX(const GUI_RECT * pRect,  
                        GUI_COLOR  Color0,  
                        GUI_COLOR  Color1);
```

#### Parameters

| Parameter           | Description   |
|---------------------|---|
| <code>pRect</code>  | Pointer to a GUI_RECT structure.                          |
| <code>Color0</code> | Color to be drawn on the leftmost side of the rectangle.  |
| <code>Color1</code> | Color to be drawn on the rightmost side of the rectangle. |

### 5.3.1.2.8 GUI\_DrawGradientV()

#### Description

Draws a rectangle filled with a vertical color gradient.

#### Prototype

```
void GUI_DrawGradientV(int    x0,  
                      int    y0,  
                      int    x1,  
                      int    y1,  
                      GUI_COLOR Color0,  
                      GUI_COLOR Color1);
```

#### Parameters

| Parameter           | Description  |
|---------------------|--|
| <code>x0</code>     | Upper left X-position.                                     |
| <code>y0</code>     | Upper left Y-position.                                     |
| <code>x1</code>     | Lower right X-position.                                    |
| <code>y1</code>     | Lower right Y-position.                                    |
| <code>Color0</code> | Color to be drawn on the topmost side of the rectangle.    |
| <code>Color1</code> | Color to be drawn on the bottommost side of the rectangle. |

#### Example

```
GUI_DrawGradientV(0, 0, 99, 99, 0x0000FF, 0x00FFFF);
```

#### Screenshot of above example





### 5.3.1.2.9 GUI\_DrawGradientVEx()

#### Description

Draws a vertical color gradient from a GUI\_RECT pointer.

#### Prototype

```
void GUI_DrawGradientVEx(const GUI_RECT * pRect,  
                        GUI_COLOR  Color0,  
                        GUI_COLOR  Color1);
```

#### Parameters

| Parameter           | Description  |
|---------------------|--|
| <code>pRect</code>  | Pointer to a GUI_RECT structure.                           |
| <code>Color0</code> | Color to be drawn on the topmost side of the rectangle.    |
| <code>Color1</code> | Color to be drawn on the bottommost side of the rectangle. |

### 5.3.1.2.10 GUI\_DrawGradientRoundedH()

#### Description

Draws a rectangle with rounded corners filled with a horizontal color gradient.

#### Prototype

```
void GUI_DrawGradientRoundedH(int    x0,
                              int    y0,
                              int    x1,
                              int    y1,
                              int    rd,
                              GUI_COLOR Color0,
                              GUI_COLOR Color1);
```

#### Parameters

| Parameter           | Description   |
|---------------------|---|
| <code>x0</code>     | Upper left X-position.                                    |
| <code>y0</code>     | Upper left Y-position.                                    |
| <code>x1</code>     | Lower right X-position.                                   |
| <code>y1</code>     | Lower right Y-position.                                   |
| <code>rd</code>     | Radius to be used for the rounded corners.                |
| <code>Color0</code> | Color to be drawn on the leftmost side of the rectangle.  |
| <code>Color1</code> | Color to be drawn on the rightmost side of the rectangle. |

#### Example

```
GUI_DrawGradientRoundedH(0, 0, 99, 99, 25, 0x0000FF, 0x00FFFF);
```

#### Screenshot of above example



### 5.3.1.2.11 GUI\_DrawGradientRoundedHEx()

#### Description

Draws a rectangle with rounded corners filled with a horizontal color gradient.

#### Prototype

```
void GUI_DrawGradientRoundedHEx(const GUI_RECT * pRect,
                                int          rd,
                                GUI_COLOR   Color0,
                                GUI_COLOR   Color1);
```

#### Parameters

| Parameter           | Description   |
|---------------------|---|
| <code>pRect</code>  | Pointer to a GUI_RECT structure.                          |
| <code>rd</code>     | Radius to be used for the rounded corners.                |
| <code>Color0</code> | Color to be drawn on the leftmost side of the rectangle.  |
| <code>Color1</code> | Color to be drawn on the rightmost side of the rectangle. |

### 5.3.1.2.12 GUI\_DrawGradientRoundedV()

#### Description

Draws a rectangle with rounded corners filled with a vertical color gradient.

#### Prototype

```
void GUI_DrawGradientRoundedV(int    x0,
                              int    y0,
                              int    x1,
                              int    y1,
                              int    rd,
                              GUI_COLOR Color0,
                              GUI_COLOR Color1);
```

#### Parameters

| Parameter           | Description   |
|---------------------|---|
| <code>x0</code>     | Upper left X-position.                                    |
| <code>y0</code>     | Upper left Y-position.                                    |
| <code>x1</code>     | Lower right X-position.                                   |
| <code>y1</code>     | Lower right Y-position.                                   |
| <code>rd</code>     | Radius to be used for the rounded corners.                |
| <code>Color0</code> | Color to be drawn on the leftmost side of the rectangle.  |
| <code>Color1</code> | Color to be drawn on the rightmost side of the rectangle. |

#### Example

```
GUI_DrawGradientRoundedV(0, 0, 99, 99, 25, 0x0000FF, 0x00FFFF);
```

#### Screenshot of above example



### 5.3.1.2.13 GUI\_DrawGradientRoundedVEx()

#### Description

Draws a vertical color gradient with rounded corners from a GUI\_RECT pointer.

#### Prototype

```
void GUI_DrawGradientRoundedVEx(const GUI_RECT * pRect,
                                int          rd,
                                GUI_COLOR   Color0,
                                GUI_COLOR   Color1);
```

#### Parameters

| Parameter           | Description   |
|---------------------|---|
| <code>pRect</code>  | Pointer to a GUI_RECT structure.                          |
| <code>rd</code>     | Radius to be used for the rounded corners.                |
| <code>Color0</code> | Color to be drawn on the leftmost side of the rectangle.  |
| <code>Color1</code> | Color to be drawn on the rightmost side of the rectangle. |

### 5.3.1.2.14 GUI\_DrawGradientMH()

### 5.3.1.2.15 GUI\_DrawGradientMV()

#### Description

These functions draw a multi color gradient either horizontal or vertical.

#### Prototype

```
void GUI_DrawGradientMH(int          x0,
                       int          y0,
                       int          y1,
                       GUI_GRADIENT_INFO * pGradientInfo,
                       int          NumColors);

void GUI_DrawGradientMV(int          x0,
                       int          y0,
                       int          x1,
                       GUI_GRADIENT_INFO * pGradientInfo,
                       int          NumColors);
```

#### Parameters

| Parameter     | Description                               |
|---------------|---|
| x0            | Upper left X-position.                    |
| y0            | Upper left Y-position.                    |
| x1            | Lower right X-position.                   |
| pGradientInfo | Pointer to a GUI_GRADIENT_INFO structure. |
| NumColors     | Number of colors in pGradientInfo.        |

#### Additional information

The member Pos of the GUI\_GRADIENT\_INFO structure is used to define the start and end position of the colors. It defines also the size of the gradient (commonly known as y1).

#### Example

```
#include "GUI.h"
/*****
 *
 *      MainTask
 */
void MainTask(void) {
    GUI_GRADIENT_INFO aInfo[] = {
        {0,  GUI_RED},
        {60, GUI_GREEN},
        {120, GUI_BLUE}, // Resulting in a gradient with a size of 120 Pixel
    };
    GUI_Init();
    GUI_DrawGradientMH(0, 0, 120, &aInfo[0], GUI_COUNTOF(aInfo));
    while (1) {
        GUI_Delay(100);
    }
}
```

**5.3.1.2.16 GUI\_DrawGradientMHEx()****5.3.1.2.17 GUI\_DrawGradientMVEx()****Description**

These functions draw a multi color gradient either horizontal or vertical from a `GUI_RECT` pointer. See the functions `GUI_DrawGradientMH()` and `GUI_DrawGradientMV()` for more information.

**Prototype**

```
void GUI_DrawGradientMHEx(GUI_RECT          * pRect,
                          GUI_GRADIENT_INFO * pGradientInfo,
                          int                NumColors);

void GUI_DrawGradientMVEx(GUI_RECT          * pRect,
                          GUI_GRADIENT_INFO * pGradientInfo,
                          int                NumColors);
```

**Parameters**

| Parameter                  | Description  |
|----------------------------|--|
| <code>pRect</code>         | Pointer to a <code>GUI_RECT</code> structure.          |
| <code>pGradientInfo</code> | Pointer to a <code>GUI_GRADIENT_INFO</code> structure. |
| <code>NumColors</code>     | Number of colors in <code>pGradientInfo</code> .       |

**Additional information**

The member `Pos` of the `GUI_GRADIENT_INFO` structure is used to define the start and end position of the colors. It defines also the size of the gradient.

### 5.3.1.2.18 GUI\_DrawPixel()

#### Description

Draws a pixel at a specified position in the current window.

#### Prototype

```
void GUI_DrawPixel(int x,  
                  int y);
```

#### Parameters

| Parameter      | Description          |
|----------------|----------------------|
| <code>x</code> | X-position of pixel. |
| <code>y</code> | Y-position of pixel. |

#### Related topics

- *GUI\_DrawPoint* on page 309



### 5.3.1.2.19 GUI\_DrawPoint()

#### Description

Draws a point with the current pen size at a specified position in the current window.

#### Prototype

```
void GUI_DrawPoint(int x,  
                  int y);
```

#### Parameters

| Parameter      | Description          |
|----------------|----------------------|
| <code>x</code> | X-position of point. |
| <code>y</code> | Y-position of point. |

#### Related topics

- [GUI\\_DrawPixel](#) on page 308

### 5.3.1.2.20 GUI\_DrawRect()

#### Description

Draws a rectangle at a specified position in the current window.

#### Prototype

```
void GUI_DrawRect (int x0,  
                  int y0,  
                  int x1,  
                  int y1);
```

#### Parameters

| Parameter | Description             |
|-----------|-------------------------|
| x0        | Upper left X-position.  |
| y0        | Upper left Y-position.  |
| x1        | Lower right X-position. |
| y1        | Lower right Y-position. |

### 5.3.1.2.21 GUI\_DrawRectEx()

#### Description

Draws a rectangle in the current window at the position specified in the rectangle passed to the function.

#### Prototype

```
void GUI_DrawRectEx(const GUI_RECT * pRect);
```

#### Parameters

| Parameter          | Description   |
|--------------------|---|
| <code>pRect</code> | Pointer to a GUI_RECT-structure containing the coordinates of the rectangle |

### 5.3.1.2.22 GUI\_DrawRoundedFrame()

#### Description

Draws a frame at a specified position in the current window with rounded corners and a specified width.

#### Prototype

```
void GUI_DrawRoundedFrame(int x0,  
                          int y0,  
                          int x1,  
                          int y1,  
                          int r,  
                          int w);
```

#### Parameters

| Parameter | Description                                |
|-----------|--|
| x0        | Upper left X-position.                     |
| y0        | Upper left Y-position.                     |
| x1        | Lower right X-position.                    |
| y1        | Lower right Y-position.                    |
| r         | Radius to be used for the rounded corners. |
| w         | Width in which the frame is drawn.         |

### 5.3.1.2.23 GUI\_DrawRoundedFrameEx()

#### Description

Draws a frame at a specified position in the current window with rounded corners and a specified width.

#### Prototype

```
void GUI_DrawRoundedFrameEx(const GUI_RECT * pRect,  
                           int           r,  
                           int           w);
```

#### Parameters

| Parameter          | Description                                |
|--------------------|--|
| <code>pRect</code> | Pointer to a GUI_RECT structure.           |
| <code>r</code>     | Radius to be used for the rounded corners. |
| <code>w</code>     | Width in which the frame is drawn.         |

### 5.3.1.2.24 GUI\_DrawRoundedRect()

#### Description

Draws a rectangle at a specified position in the current window with rounded corners.

#### Prototype

```
void GUI_DrawRoundedRect(int x0,  
                        int y0,  
                        int x1,  
                        int y1,  
                        int r);
```

#### Parameters

| Parameter | Description                                |
|-----------|--|
| x0        | Upper left X-position.                     |
| y0        | Upper left Y-position.                     |
| x1        | Lower right X-position.                    |
| y1        | Lower right Y-position.                    |
| r         | Radius to be used for the rounded corners. |

### 5.3.1.2.25 GUI\_DrawRoundedRectEx()

#### Description

Draws a rectangle at a specified position in the current window with rounded corners.

#### Prototype

```
void GUI_DrawRoundedRectEx(const GUI_RECT * pRect,  
                           int           r);
```

#### Parameters

| Parameter          | Description                                |
|--------------------|--|
| <code>pRect</code> | Pointer to a GUI_RECT structure.           |
| <code>r</code>     | Radius to be used for the rounded corners. |

### 5.3.1.2.26 GUI\_FillRect()

#### Description

Draws a filled rectangular area at a specified position in the current window.

#### Prototype

```
void GUI_FillRect(int x0,  
                 int y0,  
                 int x1,  
                 int y1);
```

#### Parameters

| Parameter | Description             |
|-----------|-------------------------|
| x0        | Upper left X-position.  |
| y0        | Upper left Y-position.  |
| x1        | Lower right X-position. |
| y1        | Lower right Y-position. |

#### Additional information

Uses the current drawing mode, which normally means all pixels inside the rectangle are set.

#### Related topics

- *GUI\_InvertRect* on page 320
- *GUI\_ClearRect* on page 294



### 5.3.1.2.27 GUI\_FillRectEx()

#### Description

Draws a filled rectangular area in the current window at the position specified in the rectangle passed to the function.

#### Prototype

```
void GUI_FillRectEx(const GUI_RECT * pRect);
```

#### Parameters

| Parameter          | Description  |
|--------------------|--|
| <code>pRect</code> | Pointer to a GUI_RECT-structure containing the coordinates of the rectangle. |

### 5.3.1.2.28 GUI\_FillRoundedRect()

#### Description

Draws a filled rectangle at a specified position in the current window with rounded corners.

#### Prototype

```
void GUI_FillRoundedRect(int x0,  
                        int y0,  
                        int x1,  
                        int y1,  
                        int r);
```

#### Parameters

| Parameter | Description                                |
|-----------|--|
| x0        | Upper left X-position.                     |
| y0        | Upper left Y-position.                     |
| x1        | Lower right X-position.                    |
| y1        | Lower right Y-position.                    |
| r         | Radius to be used for the rounded corners. |

### 5.3.1.2.29 GUI\_FillRoundedRectEx()

#### Description

Draws a filled rectangle at a specified position in the current window with rounded corners.

#### Prototype

```
void GUI_FillRoundedRectEx(const GUI_RECT * pRect,  
                           int           r);
```

#### Parameters

| Parameter          | Description   |
|--------------------|---|
| <code>pRect</code> | Pointer to a <code>GUI_RECT</code> structure containing the coordinates of the rectangle. |
| <code>r</code>     | Radius to be used for the rounded corners.  |

### 5.3.1.2.30 GUI\_InvertRect()

#### Description

Draws an inverted rectangular area at a specified position in the current window.

#### Prototype

```
void GUI_InvertRect(int x0,  
                  int y0,  
                  int x1,  
                  int y1);
```

#### Parameters

| Parameter          | Description             |
|--------------------|-------------------------|
| <a href="#">x0</a> | Upper left X-position.  |
| <a href="#">y0</a> | Upper left Y-position.  |
| <a href="#">x1</a> | Lower right X-position. |
| <a href="#">y1</a> | Lower right Y-position. |

#### Related topics

- [GUI\\_FillRect](#) on page 316
- [GUI\\_ClearRect](#) on page 294

### 5.3.1.3 Alpha blending

Alpha blending is a method of combining a foreground image with the background to create the appearance of semi transparency. An alpha value determines how much of a pixel should be visible and how much of the background should show through.

#### Color information

emWin internally works with 32 bits of color information. It is important to know that emWin is able to use 2 different color formats. For details please refer to *Logical colors* on page 480. That chapter explains the differences between both logical color modes. Important here is to know that when using the default logical color format (ABGR) an alpha value of 0 means opaque and a value of 255 means completely transparent. In case of using ARGB the meaning is vice versa: 0 means completely transparent and 255 means opaque. The documentation assumes using the default format (ABGR).

#### How it works

The alpha blending is done completely automatically once it is enabled by using the function `GUI_EnableAlpha()`. This makes emWin regard the upper 8 bits of the color information as alpha value. Enabling alpha blending is required only for functions which use the background or foreground color. Bitmaps which already contain alpha values (32bpp) are automatically displayed properly, so enabling alpha blending is not required in this case.

#### Example

The following small example shows how it works:

```
GUI_EnableAlpha(1);
GUI_SetBkColor(GUI_WHITE);
GUI_Clear();
GUI_SetColor(GUI_BLACK);
GUI_DispStringHCenterAt("Alphablending", 45, 41);
GUI_SetColor(GUI_MAKE_COLOR((0x40uL << 24) | 0x0000FF));
GUI_FillRect(0, 0, 49, 49);
GUI_SetColor(GUI_MAKE_COLOR((0x80uL << 24) | 0x00FF00));
GUI_FillRect(20, 20, 69, 69);
GUI_SetColor(GUI_MAKE_COLOR((0xC0uL << 24) | 0xFF0000));
GUI_FillRect(40, 40, 89, 89);
GUI_EnableAlpha(0);
```



#### Older versions

In older versions it was required to use the function `GUI_SetAlpha()` for blending the foreground with the current background color information. This also works but is no longer required.

### 5.3.1.3.1 GUI\_EnableAlpha()

#### Description

Enables or disables automatic alpha blending.

#### Prototype

```
unsigned GUI_EnableAlpha(unsigned OnOff);
```

#### Parameters

| Parameter | Description  |
|-----------|--|
| OnOff     | 1 enables automatic alpha blending, 0 disables it. |

#### Return value

Old state.

#### Additional information

After enabling automatic alpha blending the color information of each object automatically determines its transparency. It is recommended to disable the function after it has been used to avoid unwanted behavior.

#### Note

If alpha blending does not get disabled after using it, it might have a heavy impact on the overall performance.

### 5.3.1.3.2 GUI\_PreserveTrans()

#### Description

Makes sure that alpha channel remains after drawing operations. Drawing items using an alpha value normally requires mixing the content of the framebuffer with the item color. Mixing is done by using the alpha channel of the item color as intensity information for mixing the colors. After the drawing operation the alpha value is normally lost. But there could be situations where mixing is not wanted, for example when working with a multi layer hardware. If the alpha values of a bitmap or set by `GUI_SetAlpha()` should remain as alpha channel in the frame buffer this function should be called immediately before the drawing operation. To avoid unwanted behavior and side effects on other drawing operations it is recommended to disable that function after use.

#### Prototype

```
unsigned GUI_PreserveTrans(unsigned OnOff);
```

#### Parameters

| Parameter          | Description                                       |
|--------------------|---|
| <code>OnOff</code> | 1 enables transparency preserving, 0 disables it. |

#### Return value

Old state.

### 5.3.1.3.3 GUI\_RestoreUserAlpha()

#### Description

Restores the previous state of user alpha blending. Saved in the structure passed to the function.

#### Prototype

```
U32 GUI_RestoreUserAlpha(GUI_ALPHA_STATE * pAlphaState);
```

#### Parameters

| Parameter                | Description   |
|--------------------------|---|
| <code>pAlphaState</code> | Pointer to a GUI_ALPHA_STATE structure containing information of the previous state to be restored. |

#### Return value

Current user alpha value.

#### Example

```
GUI_ALPHA_STATE AlphaState;

GUI_EnableAlpha(1);
GUI_SetBkColor(GUI_WHITE);
GUI_Clear();
GUI_SetColor(GUI_BLACK);
GUI_DispStringHCenterAt("Alphablending", 45, 41);
GUI_SetUserAlpha(&AlphaState, 0xC0);
GUI_SetColor(GUI_RED);
GUI_FillRect(0, 0, 49, 49);
GUI_SetColor(GUI_GREEN);
GUI_FillRect(20, 20, 69, 69);
GUI_SetColor(GUI_BLUE);
GUI_FillRect(40, 40, 89, 89);
GUI_RestoreUserAlpha(&AlphaState);
```





### 5.3.1.3.4 GUI\_SetAlpha()

#### Description

Enables software alpha blending for all subsequent drawing operations.

#### Parameters

| Parameter | Description   |
|-----------|---|
| Alpha     | Alpha value to be used for all subsequent drawing operations. Default is 0 which means no alpha blending. |

#### Return value

Previous value used for alpha blending.

#### Additional information

The function sets the alpha value to be used for all subsequent drawing operations. A value of 0 for parameter Alpha means opaque (alpha blending disabled) and a value of 255 means completely transparent (invisible).

Note that software alpha blending increases the CPU load. Further it is strongly recommended to set the alpha value back to the default value after finishing the drawing operations.

#### Example

```
extern const GUI_BITMAP _LogoBitmap;
GUI_SetColor(GUI_BLUE);
GUI_FillCircle(100, 50, 49);
GUI_SetColor(GUI_YELLOW);
for (i = 0; i < 100; i++) {
    U8 Alpha;
    Alpha = (i * 255 / 100);
    GUI_SetAlpha(Alpha);
    GUI_DrawHLine(i, 100 - i, 100 + i);
}
GUI_SetAlpha(0x80);
GUI_DrawBitmap(&_LogoBitmap, 30, 30);
GUI_SetColor(GUI_MAGENTA);
GUI_SetFont(&GUI_Font24B_ASCII);
GUI_SetTextMode(GUI_TM_TRANS);
GUI_DispStringHCenterAt("Alphablending", 100, 3);
GUI_SetAlpha(0); /* Set back to default (opaque) */
```

#### Screenshot of above example



### 5.3.1.3.5 GUI\_SetUserAlpha()

#### Description

Sets an additional value which is used to calculate the actual alpha value to be used.

#### Prototype

```
U32 GUI_SetUserAlpha(GUI_ALPHA_STATE * pAlphaState,
                    U32 UserAlpha);
```

#### Parameters

| Parameter                   | Description   |
|-----------------------------|---|
| <a href="#">pAlphaState</a> | Pointer to an GUI_ALPHA_STATE structure to be used to save the current state. |
| <a href="#">UserAlpha</a>   | Value to be used.   |

#### Return value

Previous value used for alpha blending.

#### Additional information

The actual alpha value is calculated as follows:

$$\text{Alpha} = \text{AlphaFromObject} + ((255 - \text{AlphaFromObject}) * \text{UserAlpha}) / 255$$

The function GUI\_RestoreUserAlpha() can be used to restore the previous state of the function.

### 5.3.1.4 Drawing bitmaps

Generally emWin is able to display any bitmap image at any display position. On 16 bit CPUs (`sizeof(int) = 2`), the size of one bitmap per default is limited to 64 KB. If larger bitmaps should be displayed with a 16 bit CPU, refer to the chapter *Configuration* on page 100.

#### 5.3.1.4.1 GUI\_DrawBitmap()

##### Description

Draws a bitmap image at a specified position in the current window.

##### Prototype

```
void GUI_DrawBitmap(const GUI_BITMAP * pBitmap,
                   int x0,
                   int y0);
```

##### Parameters

| Parameter            | Description   |
|----------------------|---|
| <code>pBitmap</code> | Pointer to the bitmap to display.                                 |
| <code>x</code>       | X-position of the upper left corner of the bitmap in the display. |
| <code>y</code>       | Y-position of the upper left corner of the bitmap in the display. |

##### Additional information

The picture data is interpreted as bit stream starting with the most significant bit (msb) of the first byte. A new line always starts at an even byte address, as the *n* th line of the bitmap starts at offset (*n* \* BytesPerLine). The bitmap can be shown at any point in the client area. Usually, the Bitmap Converter is used to generate bitmaps. Detailed information can be found in the chapter *Bitmap Converter* on page 2809.

##### Example

```
extern const GUI_BITMAP bmSeggerLogoBlue; /* declare external Bitmap */

void main() {
    GUI_Init();
    GUI_DrawBitmap(&bmSeggerLogoBlue, 45, 20);
}
```

##### Screenshot of above example



### 5.3.1.4.2 GUI\_DrawBitmapEx()

#### Description

This routine makes it possible to scale and/or to mirror a bitmap on the display.

#### Prototype

```
void GUI_DrawBitmapEx(const GUI_BITMAP * pBitmap,
                    int x0,
                    int y0,
                    int xCenter,
                    int yCenter,
                    int xMag,
                    int yMag);
```

#### Parameters

| Parameter            | Description  |
|----------------------|--|
| <code>pBitmap</code> | Pointer to the bitmap to display.  |
| <code>x0</code>      | X-position of the anchor point in the display.   |
| <code>y0</code>      | Y-position of the anchor point in the display.   |
| <code>xCenter</code> | X-position of the anchor point in the bitmap. Specifies the bitmap pixel of the bitmap which should be displayed at <code>x0</code> on the screen independent of scaling or mirroring. |
| <code>yCenter</code> | Y-position of the anchor point in the bitmap. Specifies the bitmap pixel of the bitmap which should be displayed at <code>y0</code> on the screen independent of scaling or mirroring. |
| <code>xMag</code>    | Scale factor of X-direction in the unit 1/1000. A negative value mirrors the x-axis.   |
| <code>yMag</code>    | Scale factor of Y-direction in the unit 1/1000. A negative value mirrors the y-axis.   |

#### Additional information

This function can not be used to draw RLE-compressed bitmaps and bitmaps in the format A565.

### 5.3.1.4.3 GUI\_DrawBitmapMag()

#### Description

This routine makes it possible to magnify a bitmap on the display.

#### Prototype

```
void GUI_DrawBitmapMag(const GUI_BITMAP * pBitmap,  
                       int             x0,  
                       int             y0,  
                       int             xMul,  
                       int             yMul);
```

#### Parameters

| Parameter            | Description   |
|----------------------|---|
| <code>pBitmap</code> | Pointer to the bitmap to display.                                 |
| <code>x0</code>      | X-position of the upper left corner of the bitmap in the display. |
| <code>y0</code>      | Y-position of the upper left corner of the bitmap in the display. |
| <code>XMul</code>    | Magnification factor of X-direction.                              |
| <code>YMul</code>    | Magnification factor of Y-direction.                              |

#### 5.3.1.4.4 GUI\_SetAlphaMask8888()

##### Description

That routine takes only effect on drawing non compressed true color bitmaps (GUI\_DRAW\_BMP8888 and GUI\_DRAW\_BMPM8888I). It can be used to set additional masks used for drawing the pixels of a non compressed true color bitmap.

##### Prototype

```
void GUI_SetAlphaMask8888(U32 OrMask,  
                          U32 AndMask);
```

##### Parameters

| Parameter               | Description                               |
|-------------------------|---|
| <a href="#">OrMask</a>  | Value to be OR combined with each pixel.  |
| <a href="#">AndMask</a> | Value to be AND combined with each pixel. |

### 5.3.1.5 Drawing streamed bitmaps

Streamed bitmaps can be located in addressable area (RAM or ROM) as well as external memory (e.g. on removable devices).

#### Drawing from addressable memory

There are 2 possibilities to display streamed bitmaps which are located on addressable memory. The first one is to use the function `GUI_DrawStreamedBitmap()` or the function `GUI_DrawStreamedBitmapAuto()`. The second one is to create a `GUI_BITMAP` according to the streamed bitmap and use it for a regular call of e.g. `GUI_DrawBitmap()`.

#### Drawing from external memory

Streamed bitmaps which are located on external memory can be drawn using the *...Ex()* functions. *...Ex()* functions require a pointer to a user defined `GetData()` function (see *Getting data with the ...Ex()* functions on page 476) in order to have emWin retrieve the stream self-dependently. If the format of the streamed bitmap is unknown at run-time, the function `GUI_DrawStreamedBitmapExAuto()` should be used.

#### Requirements

The *...Ex()* functions require to have enough free memory which is assigned to emWin to store at least one line of pixel data. If there is not enough free memory, the function will return immediately without having anything drawn. Using the *...Auto()* function causes the linker to add all functions referenced by the *...Auto()* function. If there is not enough memory the according function for the specific format should be used (e.g. `GUI_DrawStreamedBitmap565Ex()`).

#### Available bitmap formats

The following table shows the currently supported formats and the availability of according *...Ex()* functions:

| Format    | Description  | <i>...Ex()</i> function available |
|-----------|--|-----------------------------------|
| IDX       | Index based* bitmaps 1-8bpp.   | Yes                               |
| 444_12    | 12bpp Bitmaps, 4 bits blue, 4 bits green, 4 bits red.                                | Yes                               |
| 444_12_1  | 12bpp Bitmaps, 4 bits blue, 4 bits green, 4 bits red.                                | Yes                               |
| 444_16    | 12bpp Bitmaps, 4 bits blue, 4 bits green, 4 bits red.                                | Yes                               |
| M444_16   | 12bpp Bitmaps, 4 bits red, 4 bits green, 4 bits blue.                                | Yes                               |
| M444_12   | 12bpp Bitmaps, 4 bits red, 4 bits green, 4 bits blue.                                | Yes                               |
| M444_12_1 | 12bpp Bitmaps, 4 bits red, 4 bits green, 4 bits blue.                                | Yes                               |
| 555       | 16bpp high color bitmaps, 5 bits blue, 5 bits green, 5 bits red.                     | Yes                               |
| M555      | 16bpp high color bitmaps, 5 bits red, 5 bits green, 5 bits blue.                     | Yes                               |
| 565       | 16bpp high color bitmaps, 5 bits blue, 6 bits green, 5 bits red.                     | Yes                               |
| M565      | 16bpp high color bitmaps, 5 bits red, 6 bits green, 5 bits blue.                     | Yes                               |
| A555      | 16bpp high color bitmaps, 5 bits blue, 5 bits green, 5 bits red, 8 bit alpha channel | Yes                               |
| AM555     | 16bpp high color bitmaps, 5 bits red, 5 bits green, 5 bits blue, 8 bit alpha channel | Yes                               |
| A565      | 16bpp high color bitmaps, 5 bits blue, 6 bits green, 5 bits red, 8 bit alpha channel | Yes                               |

| Format   | Description  | ...Ex() function available |
|----------|--|----------------------------|
| AM565    | 16bpp high color bitmaps, 5 bits red, 6 bits green, 5 bits blue, 8 bit alpha channel | Yes                        |
| 24       | 24bpp true color bitmaps, 8 bits blue, 8 bits green, 8 bits red.                     | Yes                        |
| Alpha    | 32bpp true color bitmaps, 8 bits alpha, 8 bits blue, 8 bits green, 8 bits red.       | No                         |
| RLEAlpha | 8bpp alpha channel bitmaps, compressed.  | No                         |
| RLE1     | 1bpp index based bitmaps, RLE compressed.  | No                         |
| RLE4     | 4bpp index based bitmaps, RLE compressed.  | Yes                        |
| RLE8     | 8bpp index based bitmaps, RLE compressed.  | Yes                        |
| RLE16    | 16bpp (565) high color bitmaps, RLE compressed.                                      | Yes                        |
| RLEM16   | 16bpp (M565) high color bitmaps, RLE compressed.                                     | Yes                        |
| RLE32    | 32bpp (8888) true color bitmaps with alpha channel, RLE compressed.                  | Yes                        |

#### Note

\* Index based bitmaps consist of a palette of colors stated as 32bit values. All other bitmaps do not have a palette and therefore have the bitmap data stored in the format specified in the table.



### 5.3.1.5.1 GUI\_CreateBitmapFromStream()

#### Description

The function creates a bitmap structure by passing any type of bitmap stream.

#### Prototype

```
int GUI_CreateBitmapFromStream(      GUI_BITMAP      * pBMP,
                                   GUI_LOGPALETTE * pPAL,
                                   const void      * p);
```

#### Parameters

| Parameter | Description  |
|-----------|--|
| pBMP      | Pointer to a GUI_BITMAP structure to be initialized by the function.     |
| pPAL      | Pointer to a GUI_LOGPALETTE structure to be initialized by the function. |
| p         | Pointer to the data stream.  |

#### Return value

0        on success  
1        on error.

#### Additional information

This function should be used if the data stream can consist of several kinds of bitmap formats or unknown. Disadvantage of using this function is that it has a significant memory footprint. If memory usage (ROM) is a concern, it may be better to use the format specific functions below. All pointers passed to this function have to remain valid as long as the bitmap should be used (e.g. take care if using stack variables).

#### Example

The following example shows how the GUI\_CreateBitmapFromStream() functions can be used to create and draw a bitmap:

```
void DrawBitmap(const void * pData, int xPos, int yPos) {
    GUI_BITMAP      Bitmap;
    GUI_LOGPALETTE Palette;

    GUI_CreateBitmapFromStream(&Bitmap, &Palette, pData);
    GUI_DrawBitmap(&Bitmap, xPos, yPos);
}
```

- 5.3.1.5.2 GUI\_CreateBitmapFromStreamIDX()
- 5.3.1.5.3 GUI\_CreateBitmapFromStreamRLE1()
- 5.3.1.5.4 GUI\_CreateBitmapFromStreamRLE4()
- 5.3.1.5.5 GUI\_CreateBitmapFromStreamRLE8()
- 5.3.1.5.6 GUI\_CreateBitmapFromStream444\_12()
- 5.3.1.5.7 GUI\_CreateBitmapFromStream444\_12\_1()
- 5.3.1.5.8 GUI\_CreateBitmapFromStreamM444\_12()
- 5.3.1.5.9 GUI\_CreateBitmapFromStreamM444\_12\_1()
- 5.3.1.5.10 GUI\_CreateBitmapFromStream444\_16()
- 5.3.1.5.11 GUI\_CreateBitmapFromStreamM444\_16()
- 5.3.1.5.12 GUI\_CreateBitmapFromStreamA555()
- 5.3.1.5.13 GUI\_CreateBitmapFromStreamAM555()
- 5.3.1.5.14 GUI\_CreateBitmapFromStreamA565()
- 5.3.1.5.15 GUI\_CreateBitmapFromStreamAM565()
- 5.3.1.5.16 GUI\_CreateBitmapFromStream565()
- 5.3.1.5.17 GUI\_CreateBitmapFromStreamM565()
- 5.3.1.5.18 GUI\_CreateBitmapFromStream555()
- 5.3.1.5.19 GUI\_CreateBitmapFromStreamM555()
- 5.3.1.5.20 GUI\_CreateBitmapFromStreamRLE16()
- 5.3.1.5.21 GUI\_CreateBitmapFromStreamRLEM16()
- 5.3.1.5.22 GUI\_CreateBitmapFromStream24()
- 5.3.1.5.23 GUI\_CreateBitmapFromStreamAlpha()
- 5.3.1.5.24 GUI\_CreateBitmapFromStreamRLEAlpha()
- 5.3.1.5.25 GUI\_CreateBitmapFromStreamRLE32()

### Description

These functions create bitmap structures by passing bitmap streams of a known format.

### Prototype

```
int GUI_CreateBitmapFromStream<FORMAT>(          GUI_BITMAP      * pBMP,
                                               GUI_LOGPALETTE * pPAL,
                                               const void      * p);
```

## Parameters

| Parameter         | Description   |
|-------------------|---|
| <code>pBMP</code> | Pointer to a <code>GUI_BITMAP</code> structure to be initialized by the function.     |
| <code>pPAL</code> | Pointer to a <code>GUI_LOGPALETTE</code> structure to be initialized by the function. |
| <code>p</code>    | Pointer to the data stream.   |

## Supported data stream formats

The following table shows the supported data stream formats for each function:

| Function   | Supported stream format  |
|--|--|
| <code>GUI_CreateBitmapFromStreamIDX()</code>       | Streams of index based bitmaps.                                      |
| <code>GUI_CreateBitmapFromStreamRLE1()</code>      | Streams of RLE1 compressed bitmaps.                                  |
| <code>GUI_CreateBitmapFromStreamRLE4()</code>      | Streams of RLE4 compressed bitmaps.                                  |
| <code>GUI_CreateBitmapFromStreamRLE8()</code>      | Streams of RLE8 compressed bitmaps.                                  |
| <code>GUI_CreateBitmapFromStreamA555()</code>      | Streams of high color bitmaps with alpha channel (A555).             |
| <code>GUI_CreateBitmapFromStreamAM555()</code>     | Streams of high color bitmaps with alpha channel (AM555).            |
| <code>GUI_CreateBitmapFromStreamA565()</code>      | Streams of high color bitmaps with alpha channel (A565).             |
| <code>GUI_CreateBitmapFromStreamAM565()</code>     | Streams of high color bitmaps with alpha channel (AM565).            |
| <code>GUI_CreateBitmapFromStream444_12()</code>    | Streams 12bpp bitmaps (444_12).                                      |
| <code>GUI_CreateBitmapFromStream444_12_1()</code>  | Streams 12bpp bitmaps (444_12_1).                                    |
| <code>GUI_CreateBitmapFromStream444_16()</code>    | Streams 12bpp bitmaps (444_16).                                      |
| <code>GUI_CreateBitmapFromStreamM444_12()</code>   | Streams 12bpp bitmaps (M444_12).                                     |
| <code>GUI_CreateBitmapFromStreamM444_12_1()</code> | Streams 12bpp bitmaps (M444_12_1).                                   |
| <code>GUI_CreateBitmapFromStreamM444_16()</code>   | Streams 12bpp bitmaps (M444_16).                                     |
| <code>GUI_CreateBitmapFromStream565()</code>       | Streams of high color bitmaps (565).                                 |
| <code>GUI_CreateBitmapFromStreamM565()</code>      | Streams of high color bitmaps (M565).                                |
| <code>GUI_CreateBitmapFromStream555()</code>       | Streams of high color bitmaps (555).                                 |
| <code>GUI_CreateBitmapFromStreamM555()</code>      | Streams of high color bitmaps (M565).                                |
| <code>GUI_CreateBitmapFromStreamRLE16()</code>     | Streams of RLE16 compressed bitmaps.                                 |
| <code>GUI_CreateBitmapFromStreamRLEM16()</code>    | Streams of RLE16 compressed bitmaps, red and blue swapped.           |
| <code>GUI_CreateBitmapFromStream24()</code>        | Streams of 24bpp bitmaps (true color).                               |
| <code>GUI_CreateBitmapFromStreamAlpha()</code>     | Streams of 32bpp bitmaps (true color with alpha channel).            |
| <code>GUI_CreateBitmapFromStreamRLEAlpha()</code>  | Streams of RLE compressed 8bpp alpha bitmaps.                        |
| <code>GUI_CreateBitmapFromStreamRLE32()</code>     | Streams of RLE32 compressed bitmaps (true color with alpha channel). |

## Return value

- 0 On success.
- 1 On error.

**Additional information**

These functions should be used if the data stream consists of a known format. This avoids linking of unused code and keeps the binary code small.

### 5.3.1.5.26 GUI\_DrawStreamedBitmap()

#### Description

Draws a bitmap from an indexed based bitmap data stream. Note that this routine **only** works for indexed bitmap streams. If the format is not known, `GUI_DrawStreamedBitmapAuto()` should be used. Alternatively, `GUI_DrawStreamedBitmapXXX()` with the corresponding format can be used.

#### Prototype

```
void GUI_DrawStreamedBitmap(const void * p,
                           int      x,
                           int      y);
```

#### Parameters

| Parameter      | Description   |
|----------------|---|
| <code>p</code> | Pointer to the data stream.                                       |
| <code>x</code> | X-position of the upper left corner of the bitmap in the display. |
| <code>y</code> | Y-position of the upper left corner of the bitmap in the display. |

#### Additional information

The Bitmap Converter can be used to create bitmap data streams. The format of these streams does not equal the format of a bmp file. Details can be found in the chapter *Bitmap Converter* on page 2809.

### 5.3.1.5.27 GUI\_DrawStreamedBitmapAuto()

#### Description

Draws a bitmap from a bitmap data stream of any supported format.

#### Prototype

```
void GUI_DrawStreamedBitmapAuto(const void * p,  
                                int      x,  
                                int      y);
```

#### Parameters

| Parameter      | Description   |
|----------------|---|
| <code>p</code> | Pointer to the data stream.                                       |
| <code>x</code> | X-position of the upper left corner of the bitmap in the display. |
| <code>y</code> | Y-position of the upper left corner of the bitmap in the display. |

#### Additional information

Additional information can be found under `GUI_DrawStreamedBitmap()`.

### 5.3.1.5.28 GUI\_DrawStreamedBitmapEx()

#### Prototype

```
RLE32 , & GUI_BitmapMethodsRLE32Ex , LCD__RLE32_SetFunc , NoPal ) int GUI_DrawStreamedBitmapEx  
(          GUI_GET_DATA_FUNC * pfGetData,  
  const void * p,  
    int x,  
    int y);
```

### 5.3.1.5.29 GUI\_DrawStreamedBitmapExAuto()

#### Description

This function can be used for drawing bitmap data streams of any supported format if not enough RAM or ROM is available to keep the whole file within the addressable memory (RAM or ROM). The GUI library calls the function pointed by the parameter `pfGetData` to read the data. This GetData function needs to return the number of read bytes.

#### Prototype

```
int GUI_DrawStreamedBitmapExAuto(      GUI_GET_DATA_FUNC * pfGetData,
                                       const void          * p,
                                       int                  x,
                                       int                  y);
```

#### Parameters

| Parameter              | Description  |
|------------------------|--|
| <code>pfGetData</code> | Pointer to a function which is called for getting data. For details about the GetData function, refer to <i>Getting data with the ...Ex() functions</i> on page 476. |
| <code>p</code>         | Void pointer passed to the function pointed by <code>pfGetData</code> .  |
| <code>x</code>         | X-position of the upper left corner of the bitmap in the display.  |
| <code>y</code>         | Y-position of the upper left corner of the bitmap in the display.  |

#### Return value

0        on success  
1        on error.

#### Additional information

The function requires at least memory for one line of bitmap data.



- 5.3.1.5.30 GUI\_DrawStreamedBitmapA555Ex()
- 5.3.1.5.31 GUI\_DrawStreamedBitmapAM555Ex()
- 5.3.1.5.32 GUI\_DrawStreamedBitmapA565Ex()
- 5.3.1.5.33 GUI\_DrawStreamedBitmapAM565Ex()
- 5.3.1.5.34 GUI\_DrawStreamedBitmap555Ex()
- 5.3.1.5.35 GUI\_DrawStreamedBitmapM555Ex()
- 5.3.1.5.36 GUI\_DrawStreamedBitmap565Ex()
- 5.3.1.5.37 GUI\_DrawStreamedBitmapM565Ex()
- 5.3.1.5.38 GUI\_DrawStreamedBitmap24Ex()

### Description

This function can be used for drawing bitmap data streams of the respective format if not enough RAM or ROM is available to keep the whole file within the addressable memory (RAM or ROM). The GUI library calls the function pointed by the parameter `pfGetData` to read the data. This `GetData` function needs to return the number of read bytes.

### Prototype

```
int GUI_DrawStreamedBitmap<XXX>Ex(    GUI_GET_DATA_FUNC * pfGetData,
                                     const void * p,
                                     int x,
                                     int y);
```

### Parameters

| Parameter              | Description   |
|------------------------|---|
| <code>pfGetData</code> | Pointer to a function which is called for getting data. For details about the <code>GetData</code> function, refer to <i>Getting data with the ...Ex() functions</i> on page 476. |
| <code>p</code>         | Void pointer passed to the function pointed by <code>pfGetData</code> .   |
| <code>x</code>         | X-position of the upper left corner of the bitmap in the display.   |
| <code>y</code>         | Y-position of the upper left corner of the bitmap in the display.   |

### Return value

- 0 On success.
- 1 On error.

### Additional information

The functions require at least memory for one line of bitmap data.

### 5.3.1.5.39 GUI\_GetStreamedBitmapInfo()

#### Description

Returns a structure with information about the given data stream.

#### Prototype

```
void GUI_GetStreamedBitmapInfo(const void * p,  
                               GUI_BITMAPSTREAM_INFO * pInfo);
```

#### Parameters

| Parameter          | Description  |
|--------------------|--|
| <code>p</code>     | Pointer to the data stream.  |
| <code>pInfo</code> | Pointer to a GUI_BITMAPSTREAM_INFO structure to be filled by the function. |

### 5.3.1.5.40 GUI\_GetStreamedBitmapInfoEx()

#### Description

Returns a structure with information about the given data stream which does not need to be located in the addressable ROM or RAM area of the CPU.

#### Prototype

```
int GUI_GetStreamedBitmapInfoEx(      GUI_GET_DATA_FUNC      * pfGetData,
                                     const void                * p,
                                     GUI_BITMAPSTREAM_INFO     * pInfo);
```

#### Parameters

| Parameter              | Description  |
|------------------------|--|
| <code>pfGetData</code> | Pointer to a function which is called for getting data. For details about the GetData function, refer to <i>Getting data with the ...Ex() functions</i> on page 476. |
| <code>p</code>         | Void pointer passed to the function pointed by <code>pfGetData</code> .  |
| <code>pInfo</code>     | Pointer to a GUI_BITMAPSTREAM_INFO structure to be filled by the function.   |

#### Return value

0        on success  
1        on error.

#### Elements of structure GUI\_BITMAPSTREAM\_INFO

The elements of the structure GUI\_BITMAPSTREAM\_INFO are listed under *GUI\_GetStreamedBitmapInfo* on page 342.

### 5.3.1.5.41 GUI\_SetStreamedBitmapHook()

#### Description

Sets a hook function to be able to manipulate the palette of a streamed bitmap which is not located in the addressable area of the CPU. The hook function is called when executing `GUI_DrawStreamedBitmapEx()`.

#### Prototype

```
void GUI_SetStreamedBitmapHook(GUI_BITMAPSTREAM_CALLBACK pfStreamedBitmapHook);
```

#### Parameters

| Parameter                         | Description   |
|-----------------------------------|---|
| <code>pfStreamedBitmapHook</code> | Hook function to be called by <code>GUI_DrawStreamedBitmapEx()</code> . |

#### Prototype of hook function

```
void * Hook(GUI_BITMAPSTREAM_PARAM * pParam);
```

#### Parameters

| Parameter           | Description  |
|---------------------|--|
| <code>pParam</code> | Pointer to a <code>GUI_BITMAPSTREAM_PARAM</code> structure |

#### Example

```
static void * _cbStreamedBitmapHook(GUI_BITMAPSTREAM_PARAM * pParam) {
    void * p = NULL;
    int    i, NumColors;
    U32    Color;
    U32 * pColor;
    switch (pParam->Cmd) {
    case GUI_BITMAPSTREAM_GET_BUFFER:
        //
        // Allocate buffer for palette data
        //
        p = malloc(pParam->v);
        break;
    case GUI_BITMAPSTREAM_RELEASE_BUFFER:
        //
        // Release buffer
        //
        free(pParam->p);
        break;
    case GUI_BITMAPSTREAM_MODIFY_PALETTE:
        //
        // Do something with the palette...
        //
        NumColors = pParam->v;
        pColor    = (U32 *)pParam->p;
        Color     = *(pColor + pParam->v - 1);
        for (i = NumColors - 2; i >= 0; i--) {
            *(pColor + i + 1) = *(pColor + i);
        }
        *pColor = Color;
        break;
    }
    return p;
}
```

### 5.3.1.6 Drawing lines

The most frequently used drawing routines are those that draw a line from one point to another.

### 5.3.1.6.1 GUI\_DrawHLine()

#### Description

Draws a horizontal line one pixel thick from a specified starting point to a specified endpoint in the current window.

#### Prototype

```
void GUI_DrawHLine(int y0,  
                  int x0,  
                  int x1);
```

#### Parameters

| Parameter | Description          |
|-----------|----------------------|
| y         | Y-position.          |
| x0        | X-starting position. |
| x1        | X-end position.      |

#### Additional information

If  $x1 < x0$ , nothing will be displayed.

With most LCD controllers, this routine is executed very quickly because multiple pixels can be set at once and no calculations are needed. If it is clear that horizontal lines are to be drawn, this routine executes faster than the `GUI_DrawLine()` routine.

### 5.3.1.6.2 GUI\_DrawLine()

#### Description

Draws a line from a specified starting point to a specified endpoint in the current window (absolute coordinates).

#### Prototype

```
void GUI_DrawLine(int x0,  
                 int y0,  
                 int x1,  
                 int y1);
```

#### Parameters

| Parameter | Description          |
|-----------|----------------------|
| x0        | X-starting position. |
| y0        | Y-starting position. |
| x1        | X-end position.      |
| y1        | Y-end position.      |

#### Additional information

If part of the line is not visible because it is not in the current window or because part of the current window is not visible, this is due to clipping.

### 5.3.1.6.3 GUI\_DrawLineRel()

#### Description

Draws a line from the current (x, y) position to an endpoint specified by X-distance and Y-distance in the current window (relative coordinates).

#### Prototype

```
void GUI_DrawLineRel(int dx,  
                    int dy);
```

#### Parameters

| Parameter | Description                                     |
|-----------|---|
| dx        | Distance in X-direction to end of line to draw. |
| dy        | Distance in Y-direction to end of line to draw. |



#### 5.3.1.6.4 GUI\_DrawLineTo()

##### Description

Draws a line from the current (X,Y) position to an endpoint specified by X- and Y-coordinates in the current window.

##### Prototype

```
void GUI_DrawLineTo(int x,  
                   int y);
```

##### Parameters

| Parameter      | Description     |
|----------------|-----------------|
| <code>x</code> | X-end position. |
| <code>y</code> | Y-end position. |

### 5.3.1.6.5 GUI\_DrawPolyLine()

#### Description

Connects a predefined list of points with lines in the current window.

#### Prototype

```
void GUI_DrawPolyLine(const GUI_POINT * pPoints,  
                     int NumPoints,  
                     int x0,  
                     int y0);
```

#### Parameters

| Parameter              | Description                                       |
|------------------------|---|
| <code>pPoint</code>    | Pointer to the polyline to display.               |
| <code>NumPoints</code> | Number of points specified in the list of points. |
| <code>x</code>         | X-position of origin.                             |
| <code>y</code>         | Y-position of origin.                             |

#### Additional information

The starting point and endpoint of the polyline do not need to be identical.

### 5.3.1.6.6 GUI\_DrawVLine()

#### Description

Draws a vertical line one pixel thick from a specified starting point to a specified endpoint in the current window.

#### Prototype

```
void GUI_DrawVLine(int x0,  
                  int y0,  
                  int y1);
```

#### Parameters

| Parameter | Description          |
|-----------|----------------------|
| x0        | X-position.          |
| y0        | Y-starting position. |
| y1        | Y-end position.      |

#### Additional information

If  $y1 < y0$ , nothing will be displayed. With most LCD controllers, this routine is executed very quickly because multiple pixels can be set at once and no calculations are needed. If it is clear that vertical lines are to be drawn, this routine executes faster than the `GUI_DrawLine()` routine.

### 5.3.1.6.7 GUI\_GetLineStyle()

#### Description

Returns the current line style used by the function `GUI_DrawLine`.

#### Prototype

```
U8 GUI_GetLineStyle(void);
```

#### Return value

Current line style used by the function `GUI_DrawLine`.

### 5.3.1.6.8 GUI\_MoveRel()

#### Description

Moves the current line pointer relative to its current position.

#### Prototype

```
void GUI_MoveRel(int dx,  
                int dy);
```

#### Parameters

| Parameter       | Description            |
|-----------------|------------------------|
| <code>dx</code> | Distance to move in X. |
| <code>dy</code> | Distance to move in Y. |

#### Related topics

- [GUI\\_DrawLineTo](#) on page 349
- [GUI\\_MoveTo](#) on page 354

### 5.3.1.6.9 GUI\_MoveTo()

#### Description

Moves the current line pointer to the given position.

#### Prototype

```
void GUI_MoveTo(int x,  
               int y);
```

#### Parameters

| Parameter      | Description        |
|----------------|--------------------|
| <code>x</code> | New position in X. |
| <code>y</code> | New position in Y. |

### 5.3.1.6.10 GUI\_SetLineStyle()

#### Description

Sets the current line style used by the function `GUI_DrawLine()`.

#### Prototype

```
U8 GUI_SetLineStyle(U8 LineStyle);
```

#### Parameters

| Parameter              | Description   |
|------------------------|---|
| <code>LineStyle</code> | New line style to be used. A full list of available values can be found under <i>Line styles</i> on page 424. |

#### Return value

Previous line style used by the function `GUI_DrawLine()`.

#### Additional information

This function sets only the line style used by `GUI_DrawLine()`. The style will be used only with a pen size of 1.

### 5.3.1.7 Drawing polygons

The polygon drawing routines can be helpful when drawing vectorized symbols.

#### 5.3.1.7.1 GUI\_DrawPolygon()

##### Description

Draws the outline of a polygon defined by a list of points in the current window.

##### Prototype

```
void GUI_DrawPolygon(const GUI_POINT * pPoints,  
                    int NumPoints,  
                    int x0,  
                    int y0);
```

##### Parameters

| Parameter              | Description                                       |
|------------------------|---|
| <code>pPoint</code>    | Pointer to the polygon to display.                |
| <code>NumPoints</code> | Number of points specified in the list of points. |
| <code>x</code>         | X-position of origin.                             |
| <code>y</code>         | Y-position of origin.                             |

##### Additional information

The polyline drawn is automatically closed by connecting the endpoint to the starting point.



### 5.3.1.7.2 GUI\_EnlargePolygon()

#### Description

Enlarges a polygon on all sides by a specified length in pixels.

#### Prototype

```
void GUI_EnlargePolygon(    GUI_POINT * pDest,
                          const GUI_POINT * pSrc,
                          int          NumPoints,
                          int          Len);
```

#### Parameters

| Parameter              | Description   |
|------------------------|---|
| <code>pDest</code>     | Pointer to the destination polygon.                 |
| <code>pSrc</code>      | Pointer to the source polygon.                      |
| <code>NumPoints</code> | Number of points specified in the list of points.   |
| <code>Len</code>       | Length (in pixels) by which to enlarge the polygon. |

#### Additional information

Make sure the destination array of points is equal to or larger than the source array.

#### Example

```
const GUI_POINT aPoints[] = {
    { 40, 20},
    { 0, 20},
    { 20, 0}
};
GUI_POINT aEnlargedPoints[GUI_COUNTOF(aPoints)];
void Sample(void) {
    int i;
    GUI_Clear();
    GUI_SetDrawMode(GUI_DM_XOR);
    GUI_FillPolygon(aPoints, GUI_COUNTOF(aPoints), 140, 110);
    for (i = 1; i < 10; i++) {
        GUI_EnlargePolygon(aEnlargedPoints, aPoints, GUI_COUNTOF(aPoints), i * 5);
        GUI_FillPolygon(aEnlargedPoints, GUI_COUNTOF(aPoints), 140, 110);
    }
}
```

#### Screenshot of above example



### 5.3.1.7.3 GUI\_FillPolygon()

#### Description

Draws a filled polygon defined by a list of points in the current window.

#### Prototype

```
void GUI_FillPolygon(const GUI_POINT * pPoints,  
                    int NumPoints,  
                    int x0,  
                    int y0);
```

#### Parameters

| Parameter              | Description                                       |
|------------------------|---|
| <code>pPoint</code>    | Pointer to the destination polygon.               |
| <code>NumPoints</code> | Number of points specified in the list of points. |
| <code>x</code>         | X-position of origin.                             |
| <code>y</code>         | Y-position of origin.                             |

#### Additional information

The polyline drawn is automatically closed by connecting the endpoint to the starting point. It is not required that the endpoint touches the outline of the polygon.

Rendering a polygon is done by drawing one or more horizontal lines for each `y`-position of the polygon. Per default the maximum number of points used to draw the horizontal lines for one `y`-position is 12 (which means 6 lines per `y`-position). If this value needs to be increased, the macro `GUI_FP_MAXCOUNT` can be used to set the maximum number of points.

#### Example

```
#define GUI_FP_MAXCOUNT 50
```

### 5.3.1.7.4 GUI\_MagnifyPolygon()

#### Description

Magnifies a polygon by a specified factor.

#### Prototype

```
void GUI_MagnifyPolygon(      GUI_POINT * pDest,
                             const GUI_POINT * pSrc,
                             int          NumPoints,
                             int          Mag);
```

#### Parameters

| Parameter              | Description                                       |
|------------------------|---|
| <code>pDest</code>     | Pointer to the destination polygon.               |
| <code>pSrc</code>      | Pointer to the source polygon.                    |
| <code>NumPoints</code> | Number of points specified in the list of points. |
| <code>Mag</code>       | Factor used to magnify the polygon.               |

#### Additional information

Make sure the destination array of points is equal to or larger than the source array. Note the difference between enlarging and magnifying a polygon. Calling the function `GUI_EnlargePolygon()` with the parameter `Len = 1` will enlarge the polygon by one pixel on all sides, whereas the call of `GUI_MagnifyPolygon()` with the parameter `Mag = 1` will have no effect.

#### Example

```
const GUI_POINT aPoints[] = {
    { 0, 20},
    { 40, 20},
    { 20, 0}
};
GUI_POINT aMagnifiedPoints[GUI_COUNTOF(aPoints)];
void Sample(void) {
    int Mag, y = 0, Count = 4;
    GUI_Clear();
    GUI_SetColor(GUI_GREEN);
    for (Mag = 1; Mag <= 4; Mag *= 2, Count /= 2) {
        int i, x = 0;
        GUI_MagnifyPolygon(aMagnifiedPoints, aPoints, GUI_COUNTOF(aPoints), Mag);
        for (i = Count; i > 0; i--, x += 40 * Mag) {
            GUI_FillPolygon(aMagnifiedPoints, GUI_COUNTOF(aPoints), x, y);
        }
        y += 20 * Mag;
    }
}
```

**Screenshot of above example**

### 5.3.1.7.5 GUI\_RotatePolygon()

#### Description

Rotates a polygon by a specified angle.

#### Prototype

```
void GUI_RotatePolygon(    GUI_POINT * pDest,
                          const GUI_POINT * pSrc,
                          int          NumPoints,
                          float        Angle);
```

#### Parameters

| Parameter              | Description  |
|------------------------|--|
| <code>pDest</code>     | Pointer to the destination polygon.                      |
| <code>pSrc</code>      | Pointer to the source polygon.                           |
| <code>NumPoints</code> | Number of points specified in the list of points.        |
| <code>Angle</code>     | <code>Angle</code> in radian used to rotate the polygon. |

#### Additional information

Make sure the destination array of points is equal to or larger than the source array.

#### Example

The following example shows how to draw a polygon. It is available as `2DGL_DrawPolygon.c` in the examples shipped with emWin.

```
#include "gui.h"
/*****
 *
 *           The points of the arrow
 */
static const GUI_POINT aPointArrow[] = {
    { 0, -5},
    {-40, -35},
    {-10, -25},
    {-10, -85},
    { 10, -85},
    { 10, -25},
    { 40, -35},
};
static GUI_POINT aPointRotate[GUI_COUNTOF(aPointArrow)];
/*****
 *
 *           Draws a polygon
 */
static void DrawPolygon(void) {
    int r;
    int Cnt = 0;
    GUI_SetBkColor(GUI_WHITE);
    GUI_Clear();
    GUI_SetFont(&GUI_Font8x16);
    GUI_SetColor(0x0);
    GUI_DispStringAt("Polygons of arbitrary shape ", 0, 0);
    GUI_DispStringAt("in any color", 120, 20);
    GUI_SetColor(GUI_BLUE);
    /* Rotate and draw polygon */
    r = 45.0 / (2.0 * 3.141592);
    GUI_RotatePolygon(&aPointRotate[0], &aPointArrow[0], GUI_COUNTOF(aPointArrow), r);
    GUI_FillPolygon (&aPointRotate[0], 7, 100, 100);
}
/*****
```

```
*  
*           main  
*/  
void main(void) {  
    GUI_Init();  
    DrawPolygon();  
    while(1)  
        GUI_Delay(100);  
}
```

### Screenshot of above example

**Polygons of arbitrary shape  
in any color**



## 5.3.1.8 Drawing circles

### 5.3.1.8.1 GUI\_DrawCircle()

#### Description

Draws the outline of a circle of specified dimensions, at a specified position in the current window.

#### Prototype

```
void GUI_DrawCircle(int x0,  
                   int y0,  
                   int r);
```

#### Parameters

| Parameter | Description  |
|-----------|--|
| x0        | X-position of the center of the circle in pixels of the client window. |
| y0        | Y-position of the center of the circle in pixels of the client window. |
| r         | Radius of the circle (half the diameter). Must be a positive value.    |

#### Example

```
for (i = 10; i < 50; i += 3) {  
    GUI_DrawCircle(120, 60, i);  
}
```

#### Screenshot of above example

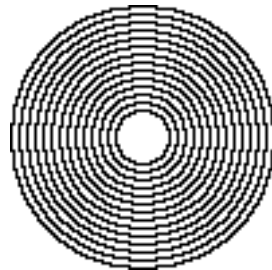

### 5.3.1.8.2 GUI\_FillCircle()

#### Description

Draws a filled circle of specified dimensions at a specified position in the current window.

#### Prototype

```
void GUI_FillCircle(int x0,  
                   int y0,  
                   int r);
```

#### Parameters

| Parameter       | Description  |
|-----------------|--|
| <code>x0</code> | X-position of the center of the circle in pixels of the client window. |
| <code>y0</code> | Y-position of the center of the circle in pixels of the client window. |
| <code>r</code>  | Radius of the circle (half the diameter). Must be a positive value.    |

#### Example

```
GUI_FillCircle(120,60,50);
```

#### Screenshot of above example





## 5.3.1.9 Drawing ellipses

### 5.3.1.9.1 GUI\_DrawEllipse()

#### Description

Draws the outline of an ellipse of specified dimensions, at a specified position in the current window.

#### Prototype

```
void GUI_DrawEllipse(int x0,
                    int y0,
                    int rx,
                    int ry);
```

#### Parameters

| Parameter       | Description  |
|-----------------|--|
| <code>x0</code> | X-position of the center of the circle in pixels of the client window. |
| <code>y0</code> | Y-position of the center of the circle in pixels of the client window. |
| <code>rx</code> | X-radius of the ellipse (half the diameter). Must be a positive value. |
| <code>ry</code> | Y-radius of the ellipse (half the diameter). Must be a positive value. |

#### Additional information

This routine is based on integer calculation. Too large ellipses cause overflows which lead to unexpected results. In that case `GUI_DrawEllipseXL()` should be used instead.

#### Example

See the `GUI_FillEllipse` on page 367 example.

### 5.3.1.9.2 GUI\_DrawEllipseXL()

#### Description

Draws the outline of a large ellipse.

#### Prototype

```
void GUI_DrawEllipseXL(int x0,  
                      int y0,  
                      int rx,  
                      int ry);
```

#### Parameters

| Parameter       | Description  |
|-----------------|--|
| <code>x0</code> | X-position of the center of the circle in pixels of the client window. |
| <code>y0</code> | Y-position of the center of the circle in pixels of the client window. |
| <code>rx</code> | X-radius of the ellipse (half the diameter). Must be a positive value. |
| <code>ry</code> | Y-radius of the ellipse (half the diameter). Must be a positive value. |

### 5.3.1.9.3 GUI\_FillEllipse()

#### Description

Draws a filled ellipse of specified dimensions at a specified position in the current window.

#### Prototype

```
void GUI_FillEllipse(int x0,  
                    int y0,  
                    int rx,  
                    int ry);
```

#### Parameters

| Parameter       | Description  |
|-----------------|--|
| <code>x0</code> | X-position of the center of the circle in pixels of the client window. |
| <code>y0</code> | Y-position of the center of the circle in pixels of the client window. |
| <code>rx</code> | X-radius of the ellipse (half the diameter). Must be a positive value. |
| <code>ry</code> | Y-radius of the ellipse (half the diameter). Must be a positive value. |

#### Example

```
// Demo ellipses  
GUI_SetColor(0xff);  
GUI_FillEllipse(100, 180, 50, 70);  
GUI_SetColor(0x0);  
GUI_DrawEllipse(100, 180, 50, 70);  
GUI_SetColor(0x000000);  
GUI_FillEllipse(100, 180, 10, 50);
```

#### Screenshot of above example



## 5.3.1.10 Drawing arcs

### 5.3.1.10.1 GUI\_DrawArc()

#### Description

Draws an arc of specified dimensions at a specified position in the current window. An arc is a section of the outline of a circle.

#### Prototype

```
void GUI_DrawArc(int x0,
                int y0,
                int rx,
                int ry,
                int a0,
                int a1);
```

#### Parameters

| Parameter | Description   |
|-----------|---|
| x0        | Horizontal position of the center in pixels of the client window. |
| y0        | Vertical position of the center in pixels of the client window.   |
| rx        | X-radius (pixels).  |
| ry        | Y-radius (pixels).  |
| a0        | Starting angle (degrees).   |
| a1        | Ending angle (degrees).   |

#### Limitations

Currently the `ry` parameter is not used. The `rx` parameter is used instead.

#### Example

```
void DrawArcScale(void) {
    int x0 = 160;
    int y0 = 180;
    int i;
    char ac[4];
    GUI_SetBkColor(GUI_WHITE);
    GUI_Clear();
    GUI_SetPenSize( 5 );
    GUI_SetTextMode(GUI_TM_TRANS);
    GUI_SetFont(&GUI_FontComic18B_ASCII);
    GUI_SetColor( GUI_BLACK );
    GUI_DrawArc( x0,y0,150, 150,-30, 210 );
    GUI_Delay(1000);
    for (i=0; i<= 23; i++) {
        float a = (-30+i*10)*3.1415926/180;
        int x = -141*cos(a)+x0;
        int y = -141*sin(a)+y0;
        if (i%2 == 0)
            GUI_SetPenSize( 5 );
        else
            GUI_SetPenSize( 4 );
        GUI_DrawPoint(x,y);
        if (i%2 == 0) {
            x = -123*cos(a)+x0;
            y = -130*sin(a)+y0;
            sprintf(ac, "%d", 10*i);
            GUI_SetTextAlign(GUI_TA_VCENTER);
            GUI_DispStringHCenterAt(ac,x,y);
```

```
}  
}  
}
```

**Screenshot of above example**

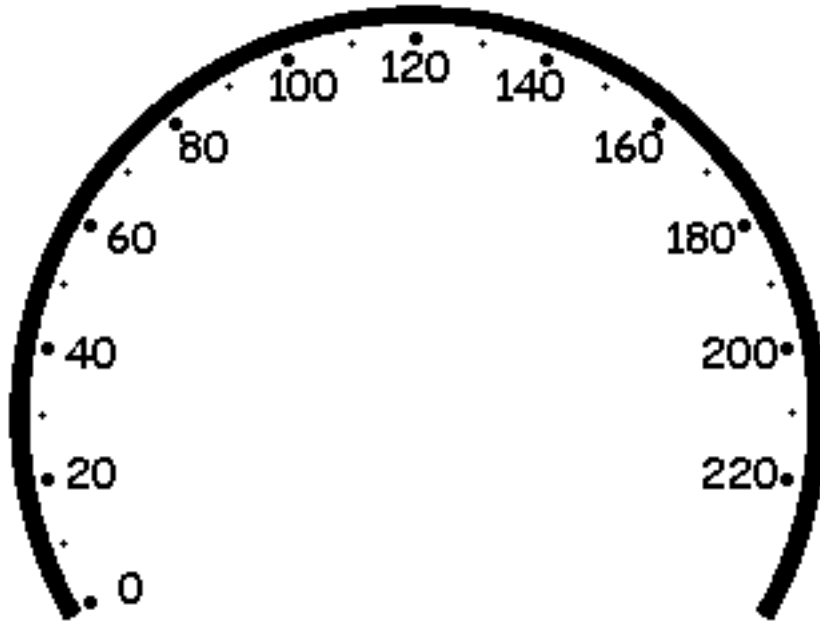

### 5.3.1.10.2 GUI\_DrawArcHR()

#### Description

Draws an arc of specified dimensions at a specified position in the current window. An arc is a section of the outline of a circle.

#### Prototype

```
void GUI_DrawArcHR(int x0,  
                  int y0,  
                  int rx,  
                  int ry,  
                  int a0,  
                  int a1);
```

#### Parameters

| Parameter | Description   |
|-----------|---|
| x0        | Horizontal position of the center in pixels of the client window. |
| y0        | Vertical position of the center in pixels of the client window.   |
| rx        | X-radius (pixels).  |
| ry        | Y-radius (pixels).  |
| a0        | Starting angle (degrees * 1000).                                  |
| a1        | Ending angle (degrees * 1000).                                    |

### 5.3.1.10.3 GUI\_DrawArcHREx()

#### Description

Draws an arc with optionally rounded ends. An arc is a section of the outline of a circle.

#### Prototype

```
void GUI_DrawArcHREx(int x0,  
                    int y0,  
                    int r,  
                    int a0,  
                    int a1,  
                    int c0,  
                    int c1);
```

#### Parameters

| Parameter | Description   |
|-----------|---|
| x0        | Horizontal position of the center in pixels of the client window. |
| y0        | Vertical position of the center in pixels of the client window.   |
| r         | Radius (in px).   |
| a0        | Starting angle (degrees * 1000).                                  |
| a1        | Ending angle (degrees * 1000).                                    |
| c0        | 1 if start of arc should be rounded, 0 if not.                    |
| c1        | 1 if end of arc should be rounded, 0 if not.                      |

## 5.3.1.11 Drawing graphs

### 5.3.1.11.1 GUI\_DrawGraph()

#### Description

Draws a graph at once.

#### Prototype

```
void GUI_DrawGraph(I16 * paY,
                  int   NumPoints,
                  int   x0,
                  int   y0);
```

#### Parameters

| Parameter              | Description   |
|------------------------|---|
| <code>paY</code>       | Pointer to an array containing the Y-values of the graph. |
| <code>NumPoints</code> | Number of Y-values to be displayed.                       |
| <code>x0</code>        | Starting point in x.                                      |
| <code>y0</code>        | Starting point in y.                                      |

#### Additional information

The function first sets the line-cursor to the position specified with `x0`, `y0` and the first Y-value of the given array. Then it starts drawing lines to `x0 + 1`, `y0 + *(paY + 1)`, `x0 + 2`, `y0 + *(paY + 2)` and so on.

#### Example

```
#include "GUI.h"
#include <stdlib.h>
I16 aY[100];
void MainTask(void) {
    int i;
    GUI_Init();
    for (i = 0; i < GUI_COUNTOF(aY); i++) {
        aY[i] = rand() % 50;
    }
    GUI_DrawGraph(aY, GUI_COUNTOF(aY), 0, 0);
}
```

#### Screenshot of above example





## 5.3.1.12 Drawing barcodes

### 5.3.1.12.1 GUI\_BARCODE\_Draw()

#### Description

Draws a barcode of the given type at the specified position.

#### Prototype

```
int GUI_BARCODE_Draw(    int    xPos,
                        int    yPos,
                        int    ModuleSize,
                        int    ySize,
                        int    Type,
                        const char * sBarcode);
```

#### Parameters

| Parameter               | Description   |
|-------------------------|---|
| <code>xPos</code>       | X-position to be used.  |
| <code>yPos</code>       | Y-position to be used.  |
| <code>ModuleSize</code> | Size of one module, that means width of the smallest bar in pixels  |
| <code>ySize</code>      | Y-size of the barcode. Cannot be lower than three times the module size.  |
| <code>Type</code>       | <code>Type</code> of the barcode to be drawn. See full list of available values under <i>Barcode types</i> on page 421. |
| <code>sBarcode</code>   | String containing the data to be used for the barcode. The ITF barcode can only display numbers.                        |

#### Return value

0           on success  
-1           on error.

#### Additional information

The data string for ITF barcodes should contain an even amount of numbers. If it does not, a leading zero will be added to the code automatically due to technical limitations.



#### Note

Barcodes can be drawn in any color. But please note that the contrast between bars and spaces has to be high enough so the code can be read successfully by a scanner. We recommend using the 'standard' colors barcodes consist of, which are white for the background (spaces) and black for the foreground (bars).

#### Examples

```
GUI_SetColor(GUI_BLACK);
GUI_SetBkColor(GUI_WHITE);
GUI_BARCODE_Draw(0, 0, 3, 60, GUI_BARCODE_ITF, "131072");
GUI_BARCODE_Draw(0, 0, 2, 60, GUI_BARCODE_128, "SEGGGER");
```

**Screenshots of above examples**

| GUI_BARCODE_ITF   | GUI_BARCODE_128  |
|---|--|
|  A barcode consisting of vertical black bars of varying widths on a white background, representing the ITF format. |  A barcode consisting of vertical black bars of varying widths on a white background, representing the 128 format. |

### 5.3.1.12.2 GUI\_BARCODE\_GetXSize()

#### Description

Returns the X-size of a given barcode without drawing it.

#### Prototype

```
int GUI_BARCODE_GetXSize(    int    Type,  
                             int    ModuleSize,  
                             const char * sBarcode);
```

#### Parameters

| Parameter  | Description  |
|------------|--|
| Type       | Type of the barcode to be drawn. See list below.   |
| ModuleSize | Size of one module, that means width of the smallest bar in pixels.                              |
| sBarcode   | String containing the data to be used for the barcode. The ITF barcode can only display numbers. |

#### Return value

X-size of the barcode on success, -1 on error.

### 5.3.1.13 Drawing QR codes



It should be made sure of that the QR code is surrounded by a bright colored frame of at least the pixel size of one 'module'. Alternatively, `GUI_QR_CreateFramed()` may be called to draw a QR code with the white frame around it.

#### 5.3.1.13.1 Memory requirement

This formula calculates the approx. number of required bytes for a QR bitmap.

```
NumReqBytes = (sqrt(((4 * Version) + 17) * Pixelsize) / 8) + 48
```

### 5.3.1.13.2 GUI\_QR\_Create()

#### Description

Creates an QR-code bitmap which can be drawn with `GUI_QR_Draw()`.

#### Prototype

```
GUI_HMEM GUI_QR_Create(const char * pText,
                      int      PixelSize,
                      int      EccLevel,
                      int      Version);
```

#### Parameters

| Parameter              | Description  |
|------------------------|--|
| <code>pText</code>     | UTF-8 text to be used for the QR-code.   |
| <code>PixelSize</code> | Size in pixels of one 'Module'.  |
| <code>EccLevel</code>  | Error correction level to be used. See full list of available values under <i>ECC levels for QR codes</i> on page 423.   |
| <code>Version</code>   | Desired size in modules of the QR-code. If set to 0 (recommended) the size will be calculated automatically. Must be between 1 and 40. If it is less than required for the given text with the given <code>EccLevel</code> , the function fails. |

#### Return value

Valid handle on success, 0 on error.

#### Additional information

After the QR code is no longer used, it should be deleted with `GUI_QR_Delete()`.

### 5.3.1.13.3 GUI\_QR\_CreateFramed()

#### Description

Creates an QR-code bitmap which can be drawn with `GUI_QR_Draw()`. A white frame by the size of one module will be added.

#### Prototype

```
GUI_HMEM GUI_QR_CreateFramed(const char * pText,
                             int      PixelSize,
                             int      EccLevel,
                             int      Version);
```

#### Parameters

| Parameter              | Description  |
|------------------------|--|
| <code>pText</code>     | UTF-8 text to be used for the QR-code.   |
| <code>PixelSize</code> | Size in pixels of one 'Module'.  |
| <code>EccLevel</code>  | Error correction level to be used. See full list of available values under <i>ECC levels for QR codes</i> on page 423.   |
| <code>Version</code>   | Desired size in modules of the QR-code. If set to 0 (recommended) the size will be calculated automatically. Must be between 1 and 40. If it is less than required for the given text with the given <code>EccLevel</code> , the function fails. |

#### Return value

Valid handle on success, 0 on error.

#### Additional information

After the QR code is no longer used, it should be deleted with `GUI_QR_Delete()`.

### 5.3.1.13.4 GUI\_QR\_Delete()

#### Description

Frees the memory used for the QR-code.

#### Prototype

```
void GUI_QR_Delete(GUI_HMEM hQR);
```

#### Parameters

| Parameter           | Description                          |
|---------------------|--------------------------------------|
| <a href="#">hQR</a> | Handle of the QR-code to be deleted. |

#### Additional information

A QR-code should be removed if it is no longer used.

### 5.3.1.13.5 GUI\_QR\_Draw()

#### Description

Draws the given QR-code at the given pixel position.

#### Prototype

```
void GUI_QR_Draw(GUI_HMEM hQR,  
                int      xPos,  
                int      yPos);
```

#### Parameters

| Parameter         | Description                        |
|-------------------|------------------------------------|
| <code>hQR</code>  | Handle of the QR-code to be drawn. |
| <code>xPos</code> | X-position to be used.             |
| <code>yPos</code> | Y-position to be used.             |



### 5.3.1.13.6 GUI\_QR\_GetInfo()

#### Description

Returns a structure containing information about the given QR-code.

#### Prototype

```
void GUI_QR_GetInfo(GUI_HMEM      hQR,  
                   GUI_QR_INFO * pInfo);
```

#### Parameters

| Parameter             | Description   |
|-----------------------|---|
| <a href="#">hQR</a>   | Handle of the QR-code to be deleted.                    |
| <a href="#">pInfo</a> | Pointer to a structure of type <code>GUI_QR_INFO</code> |

## 5.3.1.14 Drawing pie charts

### 5.3.1.14.1 GUI\_DrawPie()

#### Description

Draws a circle sector.

#### Prototype

```
void GUI_DrawPie(int x0,
                int y0,
                int r,
                int a0,
                int a1,
                int Type);
```

#### Parameters

| Parameter         | Description  |
|-------------------|--|
| <code>x0</code>   | X-position of the center of the circle in pixels of the client window. |
| <code>y0</code>   | Y-position of the center of the circle in pixels of the client window. |
| <code>r</code>    | Radius of the circle (half the diameter).                              |
| <code>a0</code>   | Starting angle (degrees).  |
| <code>a1</code>   | End angle (degrees).   |
| <code>Type</code> | (reserved for future use, should be 0)                                 |

#### Example

```
int i, a0, a1;
const unsigned aValues[] = { 100, 135, 190, 240, 340, 360};
const GUI_COLOR aColors[] = { GUI_BLUE, GUI_GREEN, GUI_RED,
                             GUI_CYAN, GUI_MAGENTA, GUI_YELLOW };
for (i = 0; i < GUI_COUNTOF(aValues); i++) {
    a0 = (i == 0) ? 0 : aValues[i - 1];
    a1 = aValues[i];
    GUI_SetColor(aColors[i]);
    GUI_DrawPie(100, 100, 50, a0, a1, 0);
}
```

#### Screenshot of above example



### 5.3.1.14.2 GUI\_DrawPieHR()

#### Description

Draws a circle sector.

#### Prototype

```
void GUI_DrawPieHR(int x0,  
                  int y0,  
                  int r,  
                  I32 a0,  
                  I32 a1);
```

#### Parameters

| Parameter       | Description  |
|-----------------|--|
| <code>x0</code> | X-position of the center of the circle in pixels of the client window. |
| <code>y0</code> | Y-position of the center of the circle in pixels of the client window. |
| <code>r</code>  | Radius of the circle (half the diameter).                              |
| <code>a0</code> | Starting angle (degrees * 1000).                                       |
| <code>a1</code> | End angle (degrees * 1000).  |

### 5.3.1.15 Drawing splines

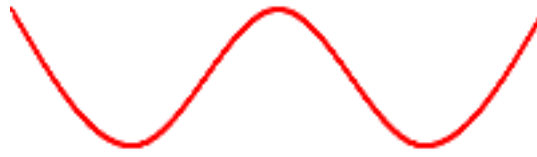

#### 5.3.1.15.1 GUI\_SPLINE\_Create()

##### Description

This function creates a spline handle with the given parameters.

##### Prototype

```
GUI_HMEM GUI_SPLINE_Create(const int      * px,
                           const int      * py,
                           unsigned       NumPoints);
```

##### Parameters

| Parameter              | Description                                      |
|------------------------|--|
| <code>px</code>        | Pointer to an array of values for x coordinates. |
| <code>py</code>        | Pointer to an array of values for y coordinates. |
| <code>NumPoints</code> | Number of points to be used.                     |

##### Return value

A handle of a spline. If zero, creation failed.

##### Additional information

The amount of points for x and y coordinates have to be the same. Please note that the values for the x coordinates have to be in a increasing order. It is not possible to create a spline where `px[0] > px[1]`.

### 5.3.1.15.2 GUI\_SPLINE\_Delete()

#### Description

This function deletes the memory allocated for a spline while it was created.

#### Prototype

```
void GUI_SPLINE_Delete(GUI_HMEM hSpline);
```

#### Parameters

| Parameter               | Description                         |
|-------------------------|-------------------------------------|
| <a href="#">hSpline</a> | Handle of the spline to be deleted. |

### 5.3.1.15.3 GUI\_SPLINE\_Draw()

#### Description

This function draws a spline created with `GUI_SPLINE_Create()` at the given position.

#### Prototype

```
void GUI_SPLINE_Draw(GUI_HMEM hSpline,  
                    int        x,  
                    int        y);
```

#### Parameters

| Parameter            | Description                  |
|----------------------|------------------------------|
| <code>hSpline</code> | Handle of a spline.          |
| <code>x</code>       | Position in <code>x</code> . |
| <code>y</code>       | Position in <code>y</code> . |

### 5.3.1.15.4 GUI\_SPLINE\_DrawAA()

#### Description

This function draws a spline created with `GUI_SPLINE_Create()` at the given position using anti aliasing.

#### Prototype

```
void GUI_SPLINE_DrawAA(GUI_HMEM hSpline,  
                       int        x,  
                       int        y,  
                       unsigned Width);
```

#### Parameters

| Parameter            | Description                                   |
|----------------------|---|
| <code>hSpline</code> | Handle of a spline.                           |
| <code>x</code>       | Position in <code>x</code> .                  |
| <code>y</code>       | Position in <code>y</code> .                  |
| <code>Width</code>   | <code>Width</code> of the spline to be drawn. |

#### Additional information

The color which is used to mix the anti aliased pixels with can be set using `GUI_SetBkColor()`. This only makes sense on a solid colored background. If the background consists of multiple colors the draw mode should be set to transparent by a call of `GUI_SetDrawMode(GUI_TM_TRANS)`.

### 5.3.1.15.5 GUI\_SPLINE\_GetY()

#### Description

This function returns the y coordinate corresponding to the given Index.

#### Prototype

```
I16 GUI_SPLINE_GetY(GUI_HMEM hSpline,  
                   unsigned Index,  
                   float * py);
```

#### Parameters

| Parameter            | Description  |
|----------------------|--|
| <code>hSpline</code> | Handle of a spline.  |
| <code>Index</code>   | Position in x.   |
| <code>py</code>      | Outpointer to store the y value as floating value (can be NULL). |

#### Return value

The y value corresponding to the given index value.

#### Additional information

IT is possible to use either the return value or if a higher precision is required the value stored in the third parameter. If the return value of this function is sufficient in regards of precision the last parameter can be NULL.



### 5.3.1.15.6 GUI\_SPLINE\_GetXSize()

#### Description

This function returns the X-size required for the spline to be drawn.

#### Prototype

```
unsigned GUI_SPLINE_GetXSize(GUI_HMEM hSpline);
```

#### Parameters

| Parameter               | Description         |
|-------------------------|---------------------|
| <a href="#">hSpline</a> | Handle of a spline. |

#### Return value

X-size in pixel required to draw the complete spline.

## 5.3.1.16 Saving and restoring the GUI context

### 5.3.1.16.1 GUI\_RestoreContext()

#### Description

The function restores the GUI-context.

#### Prototype

```
void GUI_RestoreContext(const GUI_CONTEXT * pContext);
```

#### Parameters

| Parameter             | Description  |
|-----------------------|--|
| <code>pContext</code> | Pointer to a GUI_CONTEXT structure containing the new context. |

#### Additional information

The GUI-context contains the current state of the GUI like the text cursor position, a pointer to the current font and so on. Sometimes it can be useful to save the current state to restore it later. For this you can use these functions.

### 5.3.1.16.2 GUI\_SaveContext()

#### Description

The function saves the current GUI-context.

#### Prototype

```
void GUI_SaveContext(GUI_CONTEXT * pContext);
```

#### Parameters

| Parameter             | Description  |
|-----------------------|--|
| <code>pContext</code> | Pointer to a GUI_CONTEXT structure for saving the current context. |

#### Additional information

See also the function `GUI_RestoreContext()`.

## 5.3.1.17 Info about screen changes

### 5.3.1.17.1 GUI\_DIRTYDEVICE\_Create()

#### Description

A DIRTYDEVICE is an object which makes it possible to monitor the changed area of the screen. In combination with `GUI_DIRTYDEVICE_Fetch()` it makes it possible, to check if the content of the screen has been changed. If changes have been detected the function `GUI_DIRTYDEVICE_Fetch()` returns 1 and fills up an information structure with size and position of the changed area. If nothing has been changed `GUI_DIRTYDEVICE_Fetch()` returns 0.

In case of working with multiple layers the function does not monitor all layers simultaneously. For each layer a separate DIRTYDEVICE needs to be created (if monitoring is required).

Calling `GUI_DIRTYDEVICE_Create()` creates such an monitoring object in the currently selected layer which then automatically monitors all screen drawing operations. If no longer used it can be deleted with `GUI_DIRTYDEVICE_Delete()`.

#### Prototype

```
int GUI_DIRTYDEVICE_Create(void);
```

#### Return value

|   |            |
|---|------------|
| 0 | on success |
| 1 | on error.  |

#### Additional information

A DIRTYDEVICE is also able to return advanced information like a pointer to the first changed pixel, the number of bytes used per pixel and the stride value in pixels from one line of data to the next line. To be able to use those features, a linear addressable driver is required. Further, the DIRTYDEVICE needs to be created in `LCD_X_Config()` immediately after the driver of the layer was created.

### 5.3.1.17.2 GUI\_DIRTYDEVICE\_CreateEx()

#### Description

Creates a DIRTYDEVICE in the given layer. For details please refer to the function GUI\_DIRTYDEVICE\_Create().

#### Prototype

```
int GUI_DIRTYDEVICE_CreateEx(int LayerIndex);
```

#### Parameters

| Parameter  | Description            |
|------------|------------------------|
| LayerIndex | LayerIndex to be used. |

#### Return value

0        on success  
1        on error.

### 5.3.1.17.3 GUI\_DIRTYDEVICE\_Delete()

#### Description

Removes the DIRTYDEVICE of the currently selected layer. If not possible the function returns an error.

#### Prototype

```
int GUI_DIRTYDEVICE_Delete(void);
```

#### Return value

|   |            |
|---|------------|
| 0 | on success |
| 1 | on error.  |

### 5.3.1.17.4 GUI\_DIRTYDEVICE\_DeleteEx()

#### Description

Removes the DIRTYDEVICE of the given layer. If not possible the function returns an error.

#### Prototype

```
int GUI_DIRTYDEVICE_DeleteEx(int LayerIndex);
```

#### Parameters

| Parameter  | Description            |
|------------|------------------------|
| LayerIndex | LayerIndex to be used. |

#### Return value

0        on success  
1        on error.

### 5.3.1.17.5 GUI\_DIRTYDEVICE\_Fetch()

#### Description

The function fills the given structure with the coordinates and the size of the changed screenarea of the current layer. If no changes have been detected since the last call the function returns 0.

#### Prototype

```
int GUI_DIRTYDEVICE_Fetch(GUI_DIRTYDEVICE_INFO * pInfo);
```

#### Parameters

| Parameter          | Description  |
|--------------------|--|
| <code>pInfo</code> | Pointer to the GUI_DIRTYDEVICE_INFO-structure which is filled with size and coordinates of the changed area. |

#### Return value

- 0 if no changes have been detected
- 1 if changes are detected.



### 5.3.1.17.6 GUI\_DIRTYDEVICE\_FetchEx()

#### Description

The function fills the given structure with the coordinates and the size of the changed screenarea of the given layer.

#### Prototype

```
int GUI_DIRTYDEVICE_FetchEx(GUI_DIRTYDEVICE_INFO * pInfo,
                           int LayerIndex);
```

#### Parameters

| Parameter               | Description  |
|-------------------------|--|
| <code>pInfo</code>      | Pointer to the <code>GUI_DIRTYDEVICE_INFO</code> -structure which is filled with size and coordinates of the changed area. |
| <code>LayerIndex</code> | Layer index to be used.  |

#### Elements of structure GUI\_DIRTYDEVICE\_INFO

Refer to *GUI\_DIRTYDEVICE\_Fetch* on page 396 for the elements of the structure `GUI_DIRTYDEVICE_INFO`.

#### Return value

- 0 if no changes have been detected
- 1 if changes are detected.

## 5.3.1.18 YUV device

### 5.3.1.18.1 GUI\_YUV\_Create()

#### Description

Creates a YUV device in the current layer. For details please refer to `GUI_YUV_CreateEx()`.

#### Prototype

```
int GUI_YUV_Create(void);
```

#### Return value

= 0      if successful.  
≠ 0      if the creation fails.

### 5.3.1.18.2 GUI\_YUV\_CreateEx()

#### Description

Creates a YUV device in the given layer with the given period. It allocates an additional buffer for a YUV plane for the complete given layer. Memory requirement is 2 bytes per pixel. Please note that YUV devices are supported only for display drivers with direct interface like GUIDRV\_Lin. In the given period it (re)calculates the 'dirty' framebuffer area from RGB data into YUV data.

#### Prototype

```
int GUI_YUV_CreateEx(int LayerIndex,
                    unsigned Period);
```

#### Parameters

| Parameter  | Description                  |
|------------|------------------------------|
| LayerIndex | The layer to be used.        |
| Period     | The period in ms to be used. |

#### Return value

= 0 if successful.  
≠ 0 if the creation fails.

#### Additional information

Please note that the calculation from RGB to YUV requires a lot of CPU load.

### 5.3.1.18.3 GUI\_YUV\_Delete()

#### Description

Deletes the YUV device of the current layer.

#### Prototype

```
int GUI_YUV_Delete(void);
```

#### Return value

= 0      if successful.  
≠ 0      on error.

### 5.3.1.18.4 GUI\_YUV\_DeleteEx()

#### Description

Deletes the YUV device of the given layer.

#### Prototype

```
int GUI_YUV_DeleteEx(int LayerIndex);
```

#### Parameters

| Parameter               | Description           |
|-------------------------|-----------------------|
| <code>LayerIndex</code> | The layer to be used. |

#### Return value

= 0      if successful.  
≠ 0      on error.

### 5.3.1.18.5 GUI\_YUV\_GetpData()

#### Description

Returns a pointer to the YUV plane of the current layer and the size of the plane in bytes.

#### Prototype

```
U32 *GUI_YUV_GetpData(U32 * pSize);
```

#### Parameters

| Parameter          | Description  |
|--------------------|--|
| <code>pSize</code> | Pointer to a U32 value for returning the plane size. |

#### Return value

Pointer to the YUV plane.

### 5.3.1.18.6 GUI\_YUV\_GetpDataEx()

#### Description

Returns a pointer to the YUV plane of the given layer and the size of the plane in bytes.

#### Prototype

```
U32 *GUI_YUV_GetpDataEx(int LayerIndex,  
                        U32 * pSize);
```

#### Parameters

| Parameter                  | Description  |
|----------------------------|--|
| <a href="#">LayerIndex</a> | The layer to be used.                                |
| <a href="#">pSize</a>      | Pointer to a U32 value for returning the plane size. |

#### Return value

Pointer to the YUV plane.

### 5.3.1.18.7 GUI\_YUV\_InvalidateArea()

#### Description

Invalidates the given area of the current layer. During the next interval that area will be (re)calculated.

#### Prototype

```
void GUI_YUV_InvalidateArea(int x,  
                           int y,  
                           int xSize,  
                           int ySize);
```

#### Parameters

| Parameter          | Description           |
|--------------------|-----------------------|
| <code>x</code>     | X-position in pixels. |
| <code>y</code>     | Y-position in pixels. |
| <code>xSize</code> | Y-size in pixels.     |
| <code>xSize</code> | Y-size in pixels.     |



### 5.3.1.18.8 GUI\_YUV\_SetPeriod()

#### Description

Sets the recalculation period of the YUV device in the current layer.

#### Prototype

```
int GUI_YUV_SetPeriod(unsigned Period);
```

#### Parameters

| Parameter           | Description                 |
|---------------------|-----------------------------|
| <code>Period</code> | The period in ms to be used |

#### Return value

= 0      if successful.  
≠ 0      on error.

### 5.3.1.18.9 GUI\_YUV\_SetPeriodEx()

#### Description

Sets the period to be used for (re)calculation.

#### Prototype

```
int GUI_YUV_SetPeriodEx(int LayerIndex,  
                        unsigned Period);
```

#### Parameters

| Parameter  | Description                 |
|------------|-----------------------------|
| LayerIndex | The layer to be used        |
| Period     | The period in ms to be used |

#### Return value

= 0 if successful.  
≠ 0 on error.

### 5.3.1.19 Cache with color reducer

Using a cache with color reducer could make sense if the display controller does not support reading frame buffer data and/or a display driver cache uses too much RAM. If enabled all drawing operations are executed once within the cache and the given color conversion and once with the native display driver configured in `LCD_X_Config()`. To be able to use such a cache nothing needs to be configured or changed. Simply enable it with one of the following functions. After enabled only the colors of the given color conversion could be used.

#### 5.3.1.19.1 GUI\_GCACHE\_4\_Create()

##### Description

Enables a global display cache which works with 4bpp color depth for the current layer.

##### Prototype

```
int GUI_GCACHE_4_Create(const LCD_API_COLOR_CONV * pColorConvAPI);
```

##### Parameters

| Parameter                  | Description                  |
|----------------------------|------------------------------|
| <code>pColorConvAPI</code> | Color conversion to be used. |

##### Return value

0        on success  
1        on error.

##### Additional information

Once enabled only the colors of the given color conversion can be used. Reading operations or XOR-operations then use the content of the cache.

### 5.3.1.19.2 GUI\_GCACHE\_4\_CreateEx()

#### Description

Enables a global display cache which works with 4bpp color depth.

#### Prototype

```
int GUI_GCACHE_4_CreateEx(      int          LayerIndex,  
                               const LCD_API_COLOR_CONV * pColorConvAPI);
```

#### Parameters

| Parameter     | Description                  |
|---------------|------------------------------|
| LayerIndex    | Layer index to be used.      |
| pColorConvAPI | Color conversion to be used. |

#### Return value

0        on success  
1        on error.

#### Additional information

Once enabled only the colors of the given color conversion can be used. Reading operations or XOR-operations then use the content of the cache.

## 5.3.1.20 Setting hook functions

### 5.3.1.20.1 GUI\_SetAfterExitHook()

#### Description

Sets an optional function to be called during the process of deinitialization. It may be used for example to free memory the user has allocated.

#### Prototype

```
void GUI_SetAfterExitHook(void ( *pFunc)());
```

#### Parameters

| Parameter          | Description  |
|--------------------|--|
| <code>pFunc</code> | Pointer to a function called before <code>GUI_Exit()</code> returns. |

### 5.3.1.20.2 GUI\_SetAfterInitHook()

#### Description

Sets an optional function to be called during the process of initialization. It may be used for example for putting a PID into operation after the GUI has been initialized.

#### Prototype

```
void GUI_SetAfterInitHook(void ( *pFunc)());
```

#### Parameters

| Parameter          | Description  |
|--------------------|--|
| <code>pFunc</code> | Pointer to a function called immediately before <code>GUI_Init()</code> returns. |

#### Additional information

This function should be called before `GUI_Init()` is called.

### 5.3.1.20.3 GUI\_SetControlHook()

#### Description

Under certain circumstances it could make sense to have a function which is called immediately before a display driver cache operation should be executed. It could be used for example if `GUIDRV_Lin` is used for managing the content of a layer and a custom function should be used for transferring it to the display.

#### Prototype

```
void GUI_SetControlHook(void ( *pFunc)(int LayerIndex , int Cmd ));
```

#### Parameters

| Parameter          | Description  |
|--------------------|--|
| <code>pFunc</code> | Callback function to be called before a driver cache operation should be executed. |

#### Additional information

That function is called independently of the existence of a cache in the driver.

### 5.3.1.20.4 GUI\_SetRefreshHook()

#### Description

Sets a callback function which waits until the vertical non display period has been reached before updating the screen. Tearing effects could occur if the content of the frame buffer changes during the display controller is not in the vertical non display period and currently updating the screen. A detailed description of tearing effects can be found in the chapter *Multiple Buffering* on page 712. If tearing effects should not occur and the following assumptions are fulfilled that function can be used to avoid those effects:

- Display uses an indirect interface
- Display provides a tearing signal (TE)
- Display communication is fast enough for updating the frame buffer within the vertical non display period. The function sets a callback function which is called immediately before sending any content to the display controller. That gives the application the chance to wait until the display controller is within the vertical non display period. That can be achieved by polling the TE-pin of the display (if available). The function should return immediately after reaching the non display period. After that the driver sends its (dirty) content to the display controller.

#### Prototype

```
void GUI_SetRefreshHook(void ( *pFunc)());
```

#### Parameters

| Parameter          | Description  |
|--------------------|--|
| <code>pFunc</code> | Callback function to be called before a driver cache operation should be executed. |

#### Additional information

When using this function it is important to avoid writing to the display controller for each drawing operation. This can be achieved by the cache locking mechanism. Details can be found in the section *Cache group* on page 3137.



## 5.3.1.21 Data structures

### 5.3.1.21.1 GUI\_ALPHA\_STATE

#### Description

Used for storing the alpha value with `GUI_SetUserAlpha()`.

#### Type definition

```
typedef struct {  
    U32  UserAlpha;  
} GUI_ALPHA_STATE;
```

#### Structure members

| Member                    | Description             |
|---------------------------|-------------------------|
| <a href="#">UserAlpha</a> | Alpha value to be used. |

#### See also

- `GUI_SetUserAlpha()`

### 5.3.1.21.2 GUI\_BITMAPSTREAM\_INFO

#### Description

Information about a streamed bitmap.

#### Type definition

```
typedef struct {
    int XSize;
    int YSize;
    int BitsPerPixel;
    int NumColors;
    int HasTrans;
} GUI_BITMAPSTREAM_INFO;
```

#### Structure members

| Member                       | Description  |
|------------------------------|--|
| <a href="#">XSize</a>        | Pixel size in X of the image.                                      |
| <a href="#">YSize</a>        | Pixel size in Y of the image.                                      |
| <a href="#">BitsPerPixel</a> | Number of bits per pixel.  |
| <a href="#">NumColors</a>    | Number of colors in case of an index based image.                  |
| <a href="#">HasTrans</a>     | In case of an index based image 1 if transparency exist, 0 if not. |

#### See also

- [GUI\\_GetStreamedBitmapInfo\(\)](#)
- [GUI\\_GetStreamedBitmapInfoEx\(\)](#)

### 5.3.1.21.3 GUI\_BITMAPSTREAM\_PARAM

#### Description

Contains a command to be used by a set hook function for `GUI_DrawStreamedBitmapEx()`.

#### Type definition

```
typedef struct {
    int    Cmd;
    U32    v;
    void * p;
} GUI_BITMAPSTREAM_PARAM;
```

#### Structure members

| Member           | Description                            |
|------------------|--|
| <code>Cmd</code> | Command to be executed.                |
| <code>v</code>   | Depends on the command to be executed. |
| <code>p</code>   | Depends on the command to be executed. |

| Supported values for member <code>Cmd</code> |  |
|--|--|
| <code>GUI_BITMAPSTREAM_GET_BUFFER</code>     | When receiving this command the application can spend a buffer for the palette of a bitmap stream.<br>Parameters:<br><code>p</code> - Pointer to the buffer or NULL<br><code>v</code> - Requested buffer size                                  |
| <code>GUI_BITMAPSTREAM_RELEASE_BUFFER</code> | If the application has spend a buffer for the palette here the buffer should be released.<br>Parameters:<br><code>p</code> - Pointer to buffer to be released<br><code>v</code> - not used   |
| <code>GUI_BITMAPSTREAM_MODIFY_PALETTE</code> | This command is sent after loading the palette and before drawing the image to be able to modify the palette of the streamed image.<br>Parameters:<br><code>p</code> - Pointer to palette data<br><code>v</code> - Number of colors in palette |

#### See also

- `GUI_SetStreamedBitmapHook()`

### 5.3.1.21.4 GUI\_DIRTYDEVICE\_INFO

#### Description

Information about the dirty device.

#### Type definition

```
typedef struct {
    void * pData;
    int    x0;
    int    y0;
    int    xSize;
    int    ySize;
    int    LineOff;
    int    BytesPerPixel;
    int    IsDirty;
} GUI_DIRTYDEVICE_INFO;
```

#### Structure members

| Member                     | Description   |
|----------------------------|---|
| <code>pData</code>         | Pointer to the first changed pixel.*1                       |
| <code>x0</code>            | Leftmost position of changed area.                          |
| <code>y0</code>            | Topmost position of changed area.                           |
| <code>xSize</code>         | Size in X of changed area.                                  |
| <code>ySize</code>         | Size in Y of changed area.                                  |
| <code>LineOff</code>       | Number of pixels (stride) from one line to the next line.*1 |
| <code>BytesPerPixel</code> | Number of bytes required per pixel.                         |
| <code>IsDirty</code>       | Indicates if dirty pixels exist.                            |

#### See also

- `GUI_DIRTYDEVICE_Fetch()`

#### Note

\*1 Only available if the DIRTYDEVICE is created before the driver has been created.

### 5.3.1.21.5 GUI\_GRADIENT\_INFO

#### Description

Information used for drawing multi-color gradients.

#### Type definition

```
typedef struct {
    U16      Pos;
    GUI_COLOR Color;
} GUI_GRADIENT_INFO;
```

#### Structure members

| Member                | Description  |
|-----------------------|--|
| <a href="#">Pos</a>   | Start position of color. The next entry is the end position. The last entry also defines the x1 / y1 position of the gradient, either if it's a horizontal or vertical gradient. |
| <a href="#">Color</a> | <a href="#">Color</a> to be used.  |

#### Additional information

The member [Pos](#) is used to define the start and end position of the colors. It defines also the size of the gradient.

#### See also

- [GUI\\_DrawGradientMH\(\)](#)
- [GUI\\_DrawGradientMV\(\)](#)
- [GUI\\_DrawGradientMHEX\(\)](#)
- [GUI\\_DrawGradientMVEX\(\)](#)

### 5.3.1.21.6 GUI\_POINT

#### Description

Implementation of a point on the screen.

#### Type definition

```
typedef struct {  
    I16P x;  
    I16P y;  
} GUI_POINT;
```

#### Structure members

| Member            | Description              |
|-------------------|--------------------------|
| <a href="#">x</a> | X-position of the point. |
| <a href="#">y</a> | Y-position of the point. |

### 5.3.1.21.7 GUI\_QR\_INFO

#### Description

Information about a QR code.

#### Type definition

```
typedef struct {  
    int Version;  
    int Width;  
    int Size;  
} GUI_QR_INFO;
```

#### Structure members

| Member                  | Description   |
|-------------------------|---|
| <a href="#">Version</a> | <a href="#">Version</a> according to QR code documentation. |
| <a href="#">Width</a>   | Number of 'Modules'.  |
| <a href="#">Size</a>    | <a href="#">Size</a> of bitmap in pixels.                   |

#### See also

- [GUI\\_QR\\_GetInfo\(\)](#)

### 5.3.1.21.8 GUI\_RECT

#### Description

Implementation of a rectangle on the screen.

#### Type definition

```
typedef struct {  
    I16 x0;  
    I16 y0;  
    I16 x1;  
    I16 y1;  
} GUI_RECT;
```

#### Structure members

| Member | Description  |
|--------|--|
| x0     | X-position of top left point of the rectangle.     |
| y0     | Y-position of top left point of the rectangle.     |
| x1     | X-position of bottom right point of the rectangle. |
| y1     | Y-position of bottom right point of the rectangle. |



## 5.3.1.22 Defines

### 5.3.1.22.1 Barcode types

#### Description

Type of barcode to be drawn.

#### Definition

```
#define GUI_BARCODE_ITF      0
#define GUI_BARCODE_128    1
```

#### Symbols

| Definition                      | Description   |
|---------------------------------|---|
| <a href="#">GUI_BARCODE_ITF</a> | <b>Interleaved 2 of 5 (ITF)</b> which can display an even amount of digits. |
| <a href="#">GUI_BARCODE_128</a> | <b>Code128</b> which can display all 128 ASCII characters.                  |

### 5.3.1.22.2 Drawing modes

#### Description

These flags define the mode to be used for drawing operations.

#### Definition

```
#define GUI_DM_NORMAL      (0)
#define GUI_DM_XOR        (1 << 0)
#define GUI_DM_TRANS      (1 << 1)
#define GUI_DM_REV        (1 << 2)
```

#### Symbols

| Definition                 | Description  |
|----------------------------|--|
| <code>GUI_DM_NORMAL</code> | Default: The content of the display is overdrawn by the graphic.                                     |
| <code>GUI_DM_XOR</code>    | The content of the display is inverted when it is overdrawn. Restrictions are listed below.          |
| <code>GUI_DM_TRANS</code>  | When drawing shapes with a background and foreground color the background color will be transparent. |
| <code>GUI_DM_REV</code>    | Swaps background and foreground color.   |

#### Restrictions

- XOR mode is useful only when using two displayed colors inside the active window or screen.
- Functions which make use of the pen size might not work properly if the drawing mode is XOR and the pen size is unequal to 1. So before using one of those functions either the drawing mode should be set to NORMAL or the pen size should be set to 1. The functions which regard the pen size are listed in the description of *GUI\_SetPenSize* on page 292.
- When drawing bitmaps with a color depth greater than 1 bit per pixel (bpp) this drawing mode takes no effect.
- When using drawing functions such as `GUI_DrawPolyLine()` or multiple calls of `GUI_DrawLineTo()`, the fulcrums are inverted twice. The result is that these pixels remain in the background color.

### 5.3.1.22.3 ECC levels for QR codes

#### Description

Error correction level to be used by the Reed-Solomon error correction for a QR code.

#### Definition

```
#define GUI_QR_ECLEVEL_L 0
#define GUI_QR_ECLEVEL_M 1
#define GUI_QR_ECLEVEL_Q 2
#define GUI_QR_ECLEVEL_H 3
```

#### Symbols

| Definition                       | Description                                |
|----------------------------------|--|
| <a href="#">GUI_QR_ECLEVEL_L</a> | About 7% or less errors can be corrected.  |
| <a href="#">GUI_QR_ECLEVEL_M</a> | About 15% or less errors can be corrected. |
| <a href="#">GUI_QR_ECLEVEL_Q</a> | About 25% or less errors can be corrected. |
| <a href="#">GUI_QR_ECLEVEL_H</a> | About 30% or less errors can be corrected. |

### 5.3.1.22.4 Line styles

#### Description

Style how a line is drawn.

#### Definition

```
#define GUI_LS_SOLID      (0)
#define GUI_LS_DASH      (1)
#define GUI_LS_DOT       (2)
#define GUI_LS_DASHDOT   (3)
#define GUI_LS_DASHDOTDOT (4)
```

#### Symbols

| Definition                        | Description  |
|-----------------------------------|--|
| <a href="#">GUI_LS_SOLID</a>      | Lines are drawn solid (default).                         |
| <a href="#">GUI_LS_DASH</a>       | Lines are drawn dashed.                                  |
| <a href="#">GUI_LS_DOT</a>        | Lines are drawn dotted.                                  |
| <a href="#">GUI_LS_DASHDOT</a>    | Lines are drawn alternating with dashes and dots.        |
| <a href="#">GUI_LS_DASHDOTDOT</a> | Lines are drawn alternating with dashes and double dots. |

## 5.4 Displaying bitmap files

The recommended and most efficient way to display a bitmap known at compile time is to use the Bitmap Converter to convert it into a C file and add it to the project / make-file. Details about the Bitmap Converter can be found in the chapter *Bitmap Converter* on page 2809.

If the application needs to display images not known at compile time, the image needs to be available in a graphic file format supported by emWin. In this case, the image file can reside in memory or on an other storage device; it can be displayed even if the amount of available memory is less than the size of the image file. emWin currently supports BMP-, JPEG- and GIF-files. PNG-file support can be achieved by adding the PNG-library available [on our website](#) which comes with its own BSD style license. More details about PNG support can be found under *PNG file support* on page 469.

## 5.4.1 BMP file support

Although bitmaps which can be used with emWin are normally compiled and linked as C files with the application, there may be situations when using these types of structures is not desirable. A typical example would be an application that continuously references new images, such as bitmaps downloaded by the user. The following functions support `bmp` files which have been loaded into memory.

For images that you plan to re-use (e.g. a company logo) it is much more efficient to compile and link it as C file which can be used directly by emWin. This may be easily done with the Bitmap Converter.

### 5.4.1.1 Supported formats

The BMP file format has been defined by Microsoft. emWin supports the BMP file format version 3. That contains a couple of different image formats shown in the table below:

| Bits per pixel | Indexed | Compression | Supported |
|----------------|---------|-------------|-----------|
| 1              | yes     | no          | yes       |
| 4              | yes     | no          | yes       |
| 4              | yes     | yes         | yes       |
| 8              | yes     | no          | yes       |
| 8              | yes     | yes         | yes       |
| 16             | no      | no          | yes       |
| 24             | no      | no          | yes       |
| 32             | no      | no          | yes       |

### 5.4.1.2 BMP API

The table below lists the available BMP file related routines in alphabetical order. Detailed function descriptions follow:

| Routine                               | Description  |
|---------------------------------------|--|
| <code>GUI_BMP_Draw()</code>           | Draws a BMP file which has been loaded into memory.                            |
| <code>GUI_BMP_DrawEx()</code>         | Draws a BMP file which does not need to be loaded into memory.                 |
| <code>GUI_BMP_DrawScaled()</code>     | Draws a BMP file with scaling which has been loaded into memory.               |
| <code>GUI_BMP_DrawScaledEx()</code>   | Draws a BMP file with scaling which does not need to be loaded into memory.    |
| <code>GUI_BMP_EnableAlpha()</code>    | Enables alpha channel for 32bpp V3 BMP files.                                  |
| <code>GUI_BMP_GetXSize()</code>       | Returns the X-size of a BMP file loaded into memory.                           |
| <code>GUI_BMP_GetXSizeEx()</code>     | Returns the X-size of a BMP file which does not need to be loaded into memory. |
| <code>GUI_BMP_GetYSize()</code>       | Returns the Y-size of a bitmap loaded into memory.                             |
| <code>GUI_BMP_GetYSizeEx()</code>     | Returns the Y-size of a BMP file which does not need to be loaded into memory. |
| <code>GUI_BMP_Serialize()</code>      | Creates a BMP file.  |
| <code>GUI_BMP_SerializeEx()</code>    | Creates a BMP file from the given rectangle.                                   |
| <code>GUI_BMP_SerializeExBpp()</code> | Creates a BMP file from the given rectangle using the specified color depth.   |

### 5.4.1.2.1 GUI\_BMP\_Draw()

#### Description

Draws a Windows bmp file, which has been loaded into memory, at a specified position in the current window.

#### Prototype

```
int GUI_BMP_Draw(const void * pBMP,
                 int    x0,
                 int    y0);
```

#### Parameters

| Parameter         | Description  |
|-------------------|--|
| <code>pBMP</code> | Pointer to the start of the memory area in which the bmp file resides. |
| <code>x0</code>   | X-position of the upper left corner of the bitmap in the display.      |
| <code>y0</code>   | Y-position of the upper left corner of the bitmap in the display.      |

#### Return value

= 0        on success.  
 ≠ 0        if the function fails.

#### Additional information

The table at the beginning of the chapter shows the supported BMP file formats. The example `2DGL_DrawBMP.c` shows how to use the function.

### 5.4.1.2.2 GUI\_BMP\_DrawEx()

#### Description

Draws a bmp file, which does not have to be loaded into memory, at a specified position in the current window.

#### Prototype

```
int GUI_BMP_DrawEx(GUI_GET_DATA_FUNC * pfGetData,
                  void * p,
                  int x0,
                  int y0);
```

#### Parameters

| Parameter              | Description  |
|------------------------|--|
| <code>pfGetData</code> | Pointer to a function which is called for getting data. For details about the GetData function, refer to <i>Getting data with the ...Ex() functions</i> on page 476. |
| <code>p</code>         | Void pointer passed to the function pointed by <code>pfGetData</code> .  |
| <code>x0</code>        | X-position of the upper left corner of the bitmap in the display.  |
| <code>y0</code>        | Y-position of the upper left corner of the bitmap in the display.  |

#### Return value

= 0        on success.  
 ≠ 0        if the function fails.

#### Additional information

This function is used for drawing bmp files if not enough RAM is available to load the whole file into memory. The GUI library then calls the function pointed by the parameter `pfGetData` to read the data. The GetData function needs to return the number of requested bytes. The maximum number of bytes requested by the GUI is the number of bytes needed for drawing one line of the image.



### 5.4.1.2.3 GUI\_BMP\_DrawScaled()

#### Description

Draws a bmp file, which has been loaded into memory, at a specified position in the current window using scaling.

#### Prototype

```
int GUI_BMP_DrawScaled(const void * pFileData,
                      int x0,
                      int y0,
                      int Num,
                      int Denom);
```

#### Parameters

| Parameter              | Description  |
|------------------------|--|
| <code>pFileData</code> | Pointer to the start of the memory area in which the bmp file resides. |
| <code>x0</code>        | X-position of the upper left corner of the bitmap in the display.      |
| <code>y0</code>        | Y-position of the upper left corner of the bitmap in the display.      |
| <code>Num</code>       | Numerator to be used for scaling.                                      |
| <code>Denom</code>     | Denominator used for scaling.  |

#### Return value

= 0      on success.  
 ≠ 0      if the function fails.

#### Additional information

The function scales the image by building a fraction with the given numerator and denominator. If for example an image should be shrunk to 2/3 of size the parameter `Num` should be 2 and `Denom` should be 3.

### 5.4.1.2.4 GUI\_BMP\_DrawScaledEx()

#### Description

Draws a bmp file, which does not have to be loaded into memory, at a specified position in the current window using scaling.

#### Prototype

```
int GUI_BMP_DrawScaledEx(GUI_GET_DATA_FUNC * pfGetData,
                        void * p,
                        int x0,
                        int y0,
                        int Num,
                        int Denom);
```

#### Parameters

| Parameter                 | Description  |
|---------------------------|--|
| <a href="#">pfGetData</a> | Pointer to a function which is called for getting data. For details about the GetData function, refer to <i>Getting data with the ...Ex() functions</i> on page 476. |
| <a href="#">p</a>         | Void pointer passed to the function pointed by <a href="#">pfGetData</a> .   |
| <a href="#">x0</a>        | X-position of the upper left corner of the bitmap in the display.  |
| <a href="#">y0</a>        | Y-position of the upper left corner of the bitmap in the display.  |
| <a href="#">Num</a>       | Numerator to be used for scaling.  |
| <a href="#">Denom</a>     | Denominator used for scaling.  |

#### Return value

= 0      on success.  
 ≠ 0      if the function fails.

#### Additional information

The function scales the image by building a fraction with the given numerator and denominator. If for example an image should be shrunk to 2/3 of size the parameter [Num](#) should be 2 and [Denom](#) should be 3. For more details, refer to [GUI\\_BMP\\_DrawEx\(\)](#).

### 5.4.1.2.5 GUI\_BMP\_EnableAlpha()

#### Description

Enables semi-transparency for BMP files with a color depth of 32bpp.

#### Prototype

```
void GUI_BMP_EnableAlpha(void);
```

#### Additional information

The BMP file format has been defined 1990 by Microsoft. The version of that format is V3. There do not exist earlier versions. In the further course Microsoft defined V4 (with Windows 95) and V5 (with Windows 98). But applications with support for those formats are very rarely. Unfortunately the defacto standard V3 does not support semi-transparency, whereas V4 and V5 offers that feature.

The bitmap converter of emWin is able to save images with alpha channel as 32bpp BMP-file. It simply preserves the alpha values in the upper 8 bits of each pixel. These bits are not used in the V3 standard for 32bpp BMP-files. To be able to draw this kind of images saved by the BitmapConverter `GUI_BMP_EnableAlpha()` needs to be called. It should be mentioned that this kind of alpha channel support is not the same as defined in the newer versions V4 and V5.

Using `GUI_BMP_EnableAlpha()` makes only sense, if the alpha channel of 32bpp BMP-files is definitively used, because observing the alpha channel decreases the drawing performance slightly.

### 5.4.1.2.6 GUI\_BMP\_GetXSize()

#### Description

Returns the X-size of a specified bitmap which has been loaded into memory.

#### Prototype

```
int GUI_BMP_GetXSize(const void * pBMP);
```

#### Parameters

| Parameter         | Description  |
|-------------------|--|
| <code>pBMP</code> | Pointer to the start of the memory area in which the bmp file resides. |

#### Return value

X-size of the bitmap.

### 5.4.1.2.7 GUI\_BMP\_GetXSizeEx()

#### Description

Returns the X-size of a specified bmp file which does not have to be loaded into memory.

#### Prototype

```
int GUI_BMP_GetXSizeEx(GUI_GET_DATA_FUNC * pfGetData,  
                      void * p);
```

#### Parameters

| Parameter              | Description  |
|------------------------|--|
| <code>pfGetData</code> | Pointer to a function which is called for getting data. For details about the GetData function, refer to <i>Getting data with the ...Ex() functions</i> on page 476. |
| <code>p</code>         | Void pointer passed to the function pointed by <code>pfGetData</code> .  |

#### Return value

X-size of the bitmap.

### 5.4.1.2.8 GUI\_BMP\_GetYSize()

#### Description

Returns the Y-size of a specified bitmap which has been loaded into memory.

#### Prototype

```
int GUI_BMP_GetYSize(const void * pBMP);
```

#### Parameters

| Parameter         | Description  |
|-------------------|--|
| <code>pBMP</code> | Pointer to the start of the memory area in which the bmp file resides. |

#### Return value

Y-size of the bitmap.

### 5.4.1.2.9 GUI\_BMP\_GetYSizeEx()

#### Description

Returns the Y-size of a specified bmp file which does not have to be loaded into memory.

#### Prototype

```
int GUI_BMP_GetYSizeEx(GUI_GET_DATA_FUNC * pfGetData,  
                      void * p);
```

#### Parameters

| Parameter              | Description  |
|------------------------|--|
| <code>pfGetData</code> | Pointer to a function which is called for getting data. For details about the GetData function, refer to <i>Getting data with the ...Ex() functions</i> on page 476. |
| <code>p</code>         | Void pointer passed to the function pointed by <code>pfGetData</code> .  |

#### Return value

Y-size of the bitmap.

### 5.4.1.2.10 GUI\_BMP\_Serialize()

#### Description

The function creates a BMP file containing the complete content of the LCD. The BMP file is created using the color depth which is used in emWin at a maximum of 24 bpp. In case of using a color depth of less than 8bpp the color depth of the BMP file will be 8bpp.

The currently selected device is used for reading the pixel data. If a Memory Device is selected its content is written to the file.

This function does not support storing compressed BMP data.

#### Prototype

```
void GUI_BMP_Serialize(GUI_CALLBACK_VOID_U8_P * pfSerialize,
                      void * p);
```

#### Parameters

| Parameter                | Description   |
|--------------------------|---|
| <code>pfSerialize</code> | Pointer to serialization function                             |
| <code>p</code>           | Pointer to user defined data passed to serialization function |

#### Example

The following example shows how to create a BMP file under windows.

```
static void _DrawSomething(void) {
    /* Draw something */
    GUI_DrawLine(10, 10, 100, 100);
}
static void _WriteByte2File(U8 Data, void * p) {
    U32 nWritten;
    WriteFile(*(HANDLE *)p, &Data, 1, &nWritten, NULL);
}
static void _ExportToFile(void) {
    HANDLE hFile = CreateFile("C:\\GUI_BMP_Serialize.bmp", GENERIC_WRITE, 0, 0,
                             CREATE_ALWAYS, FILE_ATTRIBUTE_NORMAL, 0);
    GUI_BMP_Serialize(_WriteByte2File, &hFile);
    CloseHandle(hFile);
}
void MainTask(void) {
    GUI_Init();
    _DrawSomething();
    _ExportToFile();
}
```



### 5.4.1.2.11 GUI\_BMP\_SerializeEx()

#### Description

The function creates a BMP file containing the given area. The BMP file is created using the color depth which is used in emWin at a maximum of 24 bpp. In case of using a color depth of less than 8bpp the color depth of the BMP file will be 8bpp. The currently selected device is used for reading the pixel data. If a Memory Device is selected its content is written to the file.

This function does not support storing compressed BMP data.

#### Prototype

```
void GUI_BMP_SerializeEx(GUI_CALLBACK_VOID_U8_P * pfSerialize,
                        int x0,
                        int y0,
                        int xSize,
                        int ySize,
                        void * p);
```

#### Parameters

| Parameter                | Description  |
|--------------------------|--|
| <code>pfSerialize</code> | Pointer to user defined serialization function. See prototype below. |
| <code>x0</code>          | Start position in X to create the BMP file.                          |
| <code>y0</code>          | Start position in Y to create the BMP file.                          |
| <code>xSize</code>       | Size in X.   |
| <code>ySize</code>       | Size in Y.   |
| <code>p</code>           | Pointer to user defined data passed to serialization function.       |

#### Prototype of GUI\_CALLBACK\_VOID\_U8\_P

```
void GUI_CALLBACK_VOID_U8_P(U8 Data, void * p);
```

#### Additional information

An example can be found in the description of `GUI_BMP_Serialize()`.

### 5.4.1.2.12 GUI\_BMP\_SerializeExBpp()

#### Description

The function creates a BMP file containing the given area using the specified color depth. In case of using a color depth of less than 8bpp the color depth of the BMP file will be 8bpp. The color depth should be a multiple of 8. In case of a system color depth of more than 8bpp the color depth needs to be 16bpp or more. The currently selected device is used for reading the pixel data. If a Memory Device is selected its content is written to the file. This function does not support storing compressed BMP data.

#### Prototype

```
void GUI_BMP_SerializeExBpp(GUI_CALLBACK_VOID_U8_P * pfSerialize,
                           int x0,
                           int y0,
                           int xSize,
                           int ySize,
                           void * p,
                           int BitsPerPixel);
```

#### Parameters

| Parameter                 | Description  |
|---------------------------|--|
| <code>pfSerialize</code>  | Pointer to user defined serialization function. See prototype below. |
| <code>x0</code>           | Start position in X to create the BMP file.                          |
| <code>y0</code>           | Start position in Y to create the BMP file.                          |
| <code>xSize</code>        | Size in X.   |
| <code>ySize</code>        | Size in Y.   |
| <code>p</code>            | Pointer to user defined data passed to serialization function.       |
| <code>BitsPerPixel</code> | Color depth.   |

#### Prototype of GUI\_CALLBACK\_VOID\_U8\_P

```
void GUI_CALLBACK_VOID_U8_P(U8 Data, void * p);
```

#### Additional information

An example can be found in the description of `GUI_BMP_Serialize()` above.

## 5.4.2 JPEG file support

JPEG (pronounced "jay-peg") is a standardized compression method for full-color and gray-scale images. JPEG is intended for compressing "real-world" scenes; line drawings, cartoons and other non-realistic images are not its strong suit. JPEG is lossy, meaning that the output image is not exactly identical to the input image. Hence you must not use JPEG if you have to have identical output bits. However, on typical photographic images, very good compression levels can be obtained with no visible change, and remarkably high compression levels are possible if you can tolerate a low-quality image.

### 5.4.2.1 Supported JPEG compression methods

This software implements JPEG baseline, extended-sequential and progressive compression processes. Provision is made for supporting all variants of these processes, although some uncommon parameter settings are not implemented yet. For legal reasons, code for the arithmetic-coding variants of JPEG is not distributed. It appears that the arithmetic coding option of the JPEG spec is covered by patents owned by IBM, AT&T, and Mitsubishi. Hence arithmetic coding cannot legally be used without obtaining one or more licenses. For this reason, support for arithmetic coding has not been included. (Since arithmetic coding provides only a marginal gain over the unpatented Huffman mode, it is unlikely that very many implementations will support it.)

### 5.4.2.2 Limitations

The JPEG file support does not contain provision for the hierarchical or lossless processes defined in the standard.

Furthermore, only JPEG files based on the yCbCr and gray scale color spaces are supported.

### 5.4.2.3 Converting a JPEG file to C source

Under some circumstances it can be useful to add a JPEG file as C file to the project. In this case the JPEG file first needs to be converted to a C file. This can be done using the tool `Bin2C.exe` shipped with emWin. It can be found in the `Tools` subfolder. It converts the given binary file (in this case the JPEG file) to a C file. The filename of the C file is the same as the binary file name with the file extension `.c`. The following steps will show how to embed a JPEG file using `Bin2C`:

- Start `Bin2C.exe` and select the JPEG file to be converted to a C file, for example 'Image.jpeg' and convert it to a C file.
- Add the C file to the project.

#### Example

The following example shows how to display the converted JPEG file:

```
#include "GUI.h"
#include "Image.c" /* Include the converted C file */
void MainTask(void) {
    GUI_Init();
    GUI_JPEG_Draw(acImage, sizeof(acImage), 0, 0);
    ...
}
```

### 5.4.2.4 Displaying JPEG files

The graphic library first decodes the graphic information. If the image has to be drawn the decoding process takes considerable time. If a JPEG file is used in a frequently called callback routine of the Window Manager, the decoding process can take a considerable amount of time. The calculation time can be reduced by the use of Memory Devices. The best way would be to draw the image first into a Memory Device. In this case the decompression would be executed only one time. For more information about Memory Devices, refer to chapter *Memory Devices* on page 2626.

### 5.4.2.5 Hardware support for decoding JPEG files

It is possible to use a hardware JPEG decoder of a MCU. For further information, please refer to *Hardware JPEG decoding* on page .

### 5.4.2.6 Memory usage

The JPEG decompression uses approximately 33 KB RAM for decompression independent of the image size and a size dependent amount of bytes. The RAM requirement can be calculated as follows:

```
Approx. RAM requirement = X-Size of image * 80 bytes + 33 KB
```

The X-size dependent amount depends on the compression type of the JPEG file. The following table shows some examples:

| Compression | Size of image in pixels | RAM usage (KB) | RAM usage, size dependent (KB) |
|-------------|-------------------------|----------------|--------------------------------|
| H1V1        | 160x120                 | 45             | 12                             |
| H2V2        | 160x120                 | 46             | 13                             |
| GRAY        | 160x120                 | 38             | 4                              |

The memory required for the decompression is allocated dynamically by the emWin memory management system. After drawing the JPEG image the complete RAM will be released.

### 5.4.2.7 Progressive JPEG files

Contrary to baseline and extended-sequential JPEG files progressive JPEGs consist of multiple scans. Each of these scans is based on the previous scan(s) and refines the appearance of the JPEG image. This requires scanning the whole file even if only one line needs to be decompressed.

The structure member `Progressive` of the structure `GUI_JPEG_INFO` indicates whether a JPEG image is progressive or not.

### 5.4.2.8 JPEG API

The table below lists the available JPEG file related routines in alphabetical order. Detailed function descriptions follow:

#### Functions

| Routine                              | Description  |
|--------------------------------------|--|
| <code>GUI_JPEG_Draw()</code>         | Draws a JPEG file which has been loaded into memory.   |
| <code>GUI_JPEG_DrawEx()</code>       | Draws a JPEG file which does not need to be loaded into memory.  |
| <code>GUI_JPEG_DrawScaled()</code>   | Draws a JPEG file with scaling which has been loaded into memory.  |
| <code>GUI_JPEG_DrawScaledEx()</code> | Draws a JPEG file with scaling which does not need to be loaded into memory.   |
| <code>GUI_JPEG_GetInfo()</code>      | Fills a <code>GUI_JPEG_INFO</code> structure with information about a JPEG file, which has been loaded into memory.            |
| <code>GUI_JPEG_GetInfoEx()</code>    | Fills a <code>GUI_JPEG_INFO</code> structure with information about a JPEG file, which does not have to be loaded into memory. |

## Data structures

| Structure                     | Description                     |
|-------------------------------|---------------------------------|
| <a href="#">GUI_JPEG_INFO</a> | Information about a JPEG image. |

## 5.4.2.8.1 Functions

### 5.4.2.8.1.1 GUI\_JPEG\_Draw()

#### Description

Draws a JPEG file, which has been loaded into memory, at a specified position in the current window.

#### Prototype

```
int GUI_JPEG_Draw(const void * pFileData,
                 int    DataSize,
                 int    x0,
                 int    y0);
```

#### Parameters

| Parameter              | Description   |
|------------------------|---|
| <code>pFileData</code> | Pointer to the start of the memory area in which the JPEG file resides. |
| <code>DataSize</code>  | Number of bytes of the JPEG file.                                       |
| <code>x0</code>        | X-position of the upper left corner of the bitmap in the display.       |
| <code>y0</code>        | Y-position of the upper left corner of the bitmap in the display.       |

#### Return value

= 0      on success  
 ≠ 0      if the function fails. (The current implementation always returns 0).

#### Additional information

The `Sample` folder contains the example `2DGL_DrawJPG.c` which shows how to use the function.

### 5.4.2.8.1.2 GUI\_JPEG\_DrawEx()

#### Description

Draws a JPEG file, which does not have to be loaded into memory, at a specified position in the current window.

#### Prototype

```
int GUI_JPEG_DrawEx(GUI_GET_DATA_FUNC * pfGetData,
                   void * p,
                   int x0,
                   int y0);
```

#### Parameters

| Parameter              | Description  |
|------------------------|--|
| <code>pfGetData</code> | Pointer to a function which is called for getting data. For details about the GetData function, refer to <i>Getting data with the ...Ex() functions</i> on page 476. |
| <code>p</code>         | Void pointer passed to the function pointed by <code>pfGetData</code> .  |
| <code>x0</code>        | X-position of the upper left corner of the bitmap in the display.  |
| <code>y0</code>        | Y-position of the upper left corner of the bitmap in the display.  |

#### Return value

= 0      on success.  
 ≠ 0      if the function fails. (The current implementation always returns 0.)

#### Additional information

This function is used for drawing jpegs if not enough RAM is available to load the whole file into memory. The JPEG library then calls the function pointed by the parameter `pfGetData` to read the data.

The GetData function should return the number of available bytes. This may be less or equal the number of requested bytes. The function needs at least to return 1 new byte. The `Sample` folder contains the example `2DGL_DrawJPGScaled.c` which shows how to use a GetData function.

### 5.4.2.8.1.3 GUI\_JPEG\_DrawScaled()

#### Description

Draws a JPEG file, which has been loaded into memory, at a specified position in the current window using scaling.

#### Prototype

```
int GUI_JPEG_DrawScaled(const void * pFileData,
                       int      DataSize,
                       int      x0,
                       int      y0,
                       int      Num,
                       int      Denom);
```

#### Parameters

| Parameter              | Description   |
|------------------------|---|
| <code>pFileData</code> | Pointer to the start of the memory area in which the jpeg file resides. |
| <code>DataSize</code>  | Number of bytes of the JPEG file.                                       |
| <code>x0</code>        | X-position of the upper left corner of the bitmap in the display.       |
| <code>y0</code>        | Y-position of the upper left corner of the bitmap in the display.       |
| <code>Num</code>       | Numerator to be used for scaling.                                       |
| <code>Denom</code>     | Denominator used for scaling.   |

#### Return value

= 0      on success.

≠ 0      if the function fails. (The current implementation always returns 0).

#### Additional information

The function scales the image by building a fraction with the given numerator and denominator. If for example an image should be shrunk to 2/3 of size the parameter `Num` should be 2 and `Denom` should be 3.

The `Sample` folder contains the example `2DGL_DrawJPGScaled.c` which shows how to draw scaled JPEGs.



### 5.4.2.8.1.4 GUI\_JPEG\_DrawScaledEx()

#### Description

Draws a JPEG file, which does not have to be loaded into memory, at a specified position in the current window using scaling.

#### Prototype

```
int GUI_JPEG_DrawScaledEx(GUI_GET_DATA_FUNC * pfGetData,
                          void * p,
                          int x0,
                          int y0,
                          int Num,
                          int Denom);
```

#### Parameters

| Parameter              | Description  |
|------------------------|--|
| <code>pfGetData</code> | Pointer to a function which is called for getting data. For details about the GetData function, refer to <i>Getting data with the ...Ex() functions</i> on page 476. |
| <code>p</code>         | Void pointer passed to the function pointed by <code>pfGetData</code> .  |
| <code>x0</code>        | X-position of the upper left corner of the bitmap in the display.  |
| <code>y0</code>        | Y-position of the upper left corner of the bitmap in the display.  |
| <code>Num</code>       | Numerator to be used for scaling.  |
| <code>Denom</code>     | Denominator used for scaling.  |

#### Return value

= 0 on success.  
 ≠ 0 if the function fails. (The current implementation always returns 0).

#### Additional information

The function scales the image by building a fraction with the given numerator and denominator. If for example an image should be shrunk to 2/3 of size the parameter `Num` should be 2 and `Denom` should be 3.

For more details, refer to `GUI_JPEG_DrawEx()`. The `Sample` folder contains the example `2DGL_DrawJPGScaled.c` which shows how to use the function.

### 5.4.2.8.1.5 GUI\_JPEG\_GetInfo()

#### Description

Fills a `GUI_JPEG_INFO` structure with information about a JPEG file, which has been loaded into memory.

#### Prototype

```
int GUI_JPEG_GetInfo(const void * pFileData,
                    int DataSize,
                    GUI_JPEG_INFO * pInfo);
```

#### Parameters

| Parameter              | Description   |
|------------------------|---|
| <code>pFileData</code> | Pointer to the start of the memory area in which the JPEG file resides.         |
| <code>DataSize</code>  | Number of bytes of the JPEG file.   |
| <code>pInfo</code>     | Pointer to a <code>GUI_JPEG_INFO</code> structure to be filled by the function. |

#### Return value

= 0 on success.  
 ≠ 0 if the function fails.

#### Additional information

The Sample folder contains the example `2DGL_DrawJPG.c` which shows how to use the function.

### 5.4.2.8.1.6 GUI\_JPEG\_GetInfoEx()

#### Description

Fills a GUI\_JPEG\_INFO structure with information about a JPEG file, which does not have to be loaded into memory.

#### Prototype

```
int GUI_JPEG_GetInfoEx(GUI_GET_DATA_FUNC * pfGetData,
                      void * p,
                      GUI_JPEG_INFO * pInfo);
```

#### Parameters

| Parameter              | Description  |
|------------------------|--|
| <code>pfGetData</code> | Pointer to a function which is called for getting data. For details about the GetData function, refer to <i>Getting data with the ...Ex() functions</i> on page 476. |
| <code>p</code>         | Void pointer passed to the function pointed by <code>pfGetData</code> .  |
| <code>pInfo</code>     | Pointer to a GUI_JPEG_INFO structure to be filled by the function.   |

#### Return value

= 0      on success.  
 ≠ 0      if the function fails.

#### Additional information

For more details about the function and the parameters `pfGetData` and `p`, refer to GUI\_JPEG\_GetInfo() and GUI\_JPEG\_DrawEx(). The `Sample` folder contains the example `2DGL_DrawJPGScaled.c` which shows how to use the function.

## 5.4.2.8.2 Data structures

### 5.4.2.8.2.1 GUI\_JPEG\_INFO

#### Description

Information about a JPEG image.

#### Type definition

```
typedef struct {  
    int XSize;  
    int YSize;  
    int Progressive;  
} GUI_JPEG_INFO;
```

#### Structure members

| Member                      | Description                             |
|-----------------------------|---|
| <a href="#">XSize</a>       | X-size of the image.                    |
| <a href="#">YSize</a>       | Y-size of the image.                    |
| <a href="#">Progressive</a> | Indicates if JPEG is progressive or not |

#### See also

- [GUI\\_JPEG\\_GetInfo\(\)](#)
- [GUI\\_JPEG\\_GetInfoEx\(\)](#)

### 5.4.3 GIF file support

The GIF file format (Graphic Interchange Format) has been developed by the CompuServe Information Service in the 1980s. It has been designed to transmit images across data networks.

The GIF standard supports interlacing, transparency, application defined data, animations and rendering of raw text. Unsupported data like raw text or application specific data will be ignored by emWin.

GIF files use the LZW (Lempel-Zif-Welch) file compression method for compressing the image data. This compression method works without losing data. The output image is exactly identical to the input image.

#### 5.4.3.1 Converting a GIF file to C source

Under some circumstances it can be useful to add a GIF file as C file to the project. This can be done by exactly the same way as described before under *JPEG file support* on page 439.

#### 5.4.3.2 Displaying GIF files

The graphic library first decodes the graphic information. If the image has to be drawn the decoding process takes considerable time. If a GIF file is used in a frequently called callback routine of the Window Manager, the decoding process can take a considerable amount of time. The calculation time can be reduced by the use of Memory Devices. The best way would be to draw the image first into a Memory Device. In this case the decompression would be executed only one time. For more information about Memory Devices, refer to the chapter *Memory Devices* on page 2626.

#### 5.4.3.3 Memory usage

The GIF decompression routine of emWin needs about 16Kbytes of dynamically allocated RAM for decompression. After drawing an image the RAM which was used for decompression will be released.

#### 5.4.3.4 GIF API

The table below lists the available GIF file related routines in alphabetical order. Detailed function descriptions follow:

##### Functions

| Routine                                   | Description  |
|---|--|
| <a href="#">GUI_GIF_Draw()</a>            | Draws the first image of a GIF file which has been loaded into memory.                             |
| <a href="#">GUI_GIF_DrawEx()</a>          | Draws the first image of a GIF file which does not need to be loaded into memory.                  |
| <a href="#">GUI_GIF_DrawSub()</a>         | Draws the given sub image of a GIF file which has been loaded into memory.                         |
| <a href="#">GUI_GIF_DrawSubEx()</a>       | Draws the given sub image of a GIF file which does not need to be loaded into memory.              |
| <a href="#">GUI_GIF_DrawSubScaled()</a>   | Draws the given sub image of a GIF file with scaling which has been loaded into memory.            |
| <a href="#">GUI_GIF_DrawSubScaledEx()</a> | Draws the given sub image of a GIF file with scaling which does not need to be loaded into memory. |
| <a href="#">GUI_GIF_GetComment()</a>      | Returns the given comment of a GIF file which has been loaded into memory.                         |

| Routine                               | Description   |
|---------------------------------------|---|
| <code>GUI_GIF_GetCommentEx()</code>   | Returns the given comment of a GIF file which does not need to be loaded into memory.                     |
| <code>GUI_GIF_GetImageInfo()</code>   | Returns information about the given sub image of a GIF file which has been loaded into memory.            |
| <code>GUI_GIF_GetImageInfoEx()</code> | Returns information about the given sub image of a GIF file which does not need to be loaded into memory. |
| <code>GUI_GIF_GetInfo()</code>        | Returns information about a GIF file which has been loaded into memory.                                   |
| <code>GUI_GIF_GetInfoEx()</code>      | Returns information about a GIF file which does not need to be loaded into memory.                        |
| <code>GUI_GIF_GetXSize()</code>       | Returns the X-size of a bitmap loaded into memory.  |
| <code>GUI_GIF_GetXSizeEx()</code>     | Returns the X-size of a bitmap which does not need to be loaded into memory.                              |
| <code>GUI_GIF_GetYSize()</code>       | Returns the Y-size of a bitmap loaded into memory.  |
| <code>GUI_GIF_GetYSizeEx()</code>     | Returns the Y-size of a bitmap which does not need to be loaded into memory.                              |

### Data structures

| Structure                       | Description                                  |
|---------------------------------|--|
| <code>GUI_GIF_IMAGE_INFO</code> | Information about a sub-image in a GIF file. |
| <code>GUI_GIF_INFO</code>       | Information about a sub-image in a GIF file. |

### 5.4.3.4.1 Functions

#### 5.4.3.4.1.1 GUI\_GIF\_Draw()

##### Description

Draws the first image of a gif file, which has been loaded into memory, at a specified position in the current window.

##### Prototype

```
int GUI_GIF_Draw(const void * pGIF,
                 U32      NumBytes,
                 int      x0,
                 int      y0);
```

##### Parameters

| Parameter             | Description  |
|-----------------------|--|
| <code>pGIF</code>     | Pointer to the start of the memory area in which the gif file resides. |
| <code>NumBytes</code> | Number of bytes of the gif file.                                       |
| <code>x0</code>       | X-position of the upper left corner of the bitmap in the display.      |
| <code>y0</code>       | Y-position of the upper left corner of the bitmap in the display.      |

##### Return value

= 0      on success  
 ≠ 0      on error.

##### Additional information

If the file contains more than one image, the function shows only the first image of the file. Transparency and interlaced images are supported.

### 5.4.3.4.1.2 GUI\_GIF\_DrawEx()

#### Description

Draws a gif file, which does not have to be loaded into memory, at a specified position in the current window.

#### Prototype

```
int GUI_GIF_DrawEx(GUI_GET_DATA_FUNC * pfGetData,
                  void * p,
                  int x0,
                  int y0);
```

#### Parameters

| Parameter              | Description  |
|------------------------|--|
| <code>pfGetData</code> | Pointer to a function which is called for getting data. For details about the GetData function, refer to <i>Getting data with the ...Ex() functions</i> on page 476. |
| <code>p</code>         | Void pointer passed to the function pointed by <code>pfGetData</code> .  |
| <code>x0</code>        | X-position of the upper left corner of the bitmap in the display.  |
| <code>y0</code>        | Y-position of the upper left corner of the bitmap in the display.  |

#### Return value

= 0      on success  
 ≠ 0      on error.

#### Additional information

This function is used for drawing gif files if not enough RAM is available to load the whole file into memory. The library calls the function pointed by the parameter `pfGetData` to read the data. The GetData function should return the number of available bytes. This could be less or equal the number of requested bytes. The function needs at least to return 1 new byte.



### 5.4.3.4.1.3 GUI\_GIF\_DrawSub()

#### Description

Draws the given sub image of a gif file, which has been loaded into memory, at a specified position in the current window.

#### Prototype

```
int GUI_GIF_DrawSub(const void * pGIF,
                   U32    NumBytes,
                   int    x0,
                   int    y0,
                   int    Index);
```

#### Parameters

| Parameter             | Description  |
|-----------------------|--|
| <code>pGIF</code>     | Pointer to the start of the memory area in which the gif file resides. |
| <code>NumBytes</code> | Number of bytes of the gif file.                                       |
| <code>x0</code>       | X-position of the upper left corner of the bitmap in the display.      |
| <code>y0</code>       | Y-position of the upper left corner of the bitmap in the display.      |
| <code>Index</code>    | Zero-based index of sub image to be shown.                             |

#### Return value

= 0      on success  
 ≠ 0      on error.

#### Additional information

The function manages the background pixels between the current and the previous image. If for example sub image #3 should be drawn at offset x20/y20 with a size of w10/h10 and the previous sub image was shown at x15/y15 with a size of w20/h20 and the background needs to be redrawn, the function fills the pixels between the images with the background color. The file `2DGL_DrawGIF.c` of the Sample folder shows how to use the function.

### 5.4.3.4.1.4 GUI\_GIF\_DrawSubEx()

#### Description

Draws the given sub image of a gif file, which does not have to be loaded into memory, at a specified position in the current window.

#### Prototype

```
int GUI_GIF_DrawSubEx(GUI_GET_DATA_FUNC * pfGetData,
                    void * p,
                    int x0,
                    int y0,
                    int Index);
```

#### Parameters

| Parameter                 | Description  |
|---------------------------|--|
| <a href="#">pfGetData</a> | Pointer to a function which is called for getting data. For details about the GetData function, refer to <i>Getting data with the ...Ex() functions</i> on page 476. |
| <a href="#">p</a>         | Void pointer passed to the function pointed by <a href="#">pfGetData</a> .   |
| <a href="#">x0</a>        | X-position of the upper left corner of the bitmap in the display.  |
| <a href="#">y0</a>        | Y-position of the upper left corner of the bitmap in the display.  |
| <a href="#">Index</a>     | Zero-based index of sub image to be shown.   |

#### Return value

= 0      on success  
 ≠ 0      on error.

#### Additional information

This function is used for drawing gif images if not enough RAM is available to load the whole file into memory. The GUI library then calls the function pointed by the parameter [pfGetData](#) to read the data.

For more details, refer to the [GUI\\_GIF\\_DrawEx\(\)](#).

### 5.4.3.4.1.5 GUI\_GIF\_DrawSubScaled()

#### Description

Draws the given sub image of a gif file, which has been loaded into memory, at a specified position in the current window using scaling.

#### Prototype

```
int GUI_GIF_DrawSubScaled(const void * pGIF,
                          U32      NumBytes,
                          int      x0,
                          int      y0,
                          int      Index,
                          int      Num,
                          int      Denom);
```

#### Parameters

| Parameter             | Description  |
|-----------------------|--|
| <code>pGIF</code>     | Pointer to the start of the memory area in which the gif file resides. |
| <code>NumBytes</code> | Number of bytes of the gif file.                                       |
| <code>x0</code>       | X-position of the upper left corner of the bitmap in the display.      |
| <code>y0</code>       | Y-position of the upper left corner of the bitmap in the display.      |
| <code>Index</code>    | Zero-based index of sub image to be shown.                             |
| <code>Num</code>      | Numerator to be used for scaling.                                      |
| <code>Denom</code>    | Denominator used for scaling.  |

#### Return value

= 0      on success  
 ≠ 0      on error.

#### Additional information

The function scales the image by building a fraction with the given numerator and denominator. If for example an image should be shrunk to 2/3 of size the parameter `Num` should be 2 and `Denom` should be 3.

### 5.4.3.4.1.6 GUI\_GIF\_DrawSubScaledEx()

#### Description

Draws the given sub image of a gif file, which does not have to be loaded into memory, at a specified position in the current window using scaling.

#### Prototype

```
int GUI_GIF_DrawSubScaledEx(GUI_GET_DATA_FUNC * pfGetData,
                           void * p,
                           int x0,
                           int y0,
                           int Index,
                           int Num,
                           int Denom);
```

#### Parameters

| Parameter              | Description  |
|------------------------|--|
| <code>pfGetData</code> | Pointer to a function which is called for getting data. For details about the GetData function, refer to <i>Getting data with the ...Ex() functions</i> on page 476. |
| <code>p</code>         | Void pointer passed to the function pointed by <code>pfGetData</code> .  |
| <code>x0</code>        | X-position of the upper left corner of the bitmap in the display.  |
| <code>y0</code>        | Y-position of the upper left corner of the bitmap in the display.  |
| <code>Index</code>     | Zero-based index of sub image to be shown.   |
| <code>Num</code>       | Numerator to be used for scaling.  |
| <code>Denom</code>     | Denominator used for scaling.  |

#### Return value

= 0      on success  
 ≠ 0      on error.

#### Additional information

The function scales the image by building a fraction with the given numerator and denominator. If for example an image should be shrunk to 2/3 of size the parameter `Num` should be 2 and `Denom` should be 3.

### 5.4.3.4.1.7 GUI\_GIF\_GetComment()

#### Description

Returns the given comment from a GIF image, which has been loaded into memory.

#### Prototype

```
int GUI_GIF_GetComment(const void * pGIF,
                      U32      NumBytes,
                      U8      * pBuffer,
                      int      MaxSize,
                      int      Index);
```

#### Parameters

| Parameter             | Description  |
|-----------------------|--|
| <code>pGIF</code>     | Pointer to the start of the memory area in which the gif file resides. |
| <code>NumBytes</code> | Number of bytes of the gif file.                                       |
| <code>pBuffer</code>  | Pointer to a buffer to be filled with the comment.                     |
| <code>MaxSize</code>  | Size of the buffer.  |
| <code>Index</code>    | Zero based index of comment to be returned.                            |

#### Return value

= 0      on success  
 ≠ 0      on error.

#### Additional information

A GIF file can contain 1 or more comments. The function copies the comment into the given buffer. If the comment is larger than the given buffer only the bytes which fit into the buffer will be copied. The file `2DGL_DrawGIF.c` of the Sample folder shows how to use the function.

### 5.4.3.4.1.8 GUI\_GIF\_GetCommentEx()

#### Description

Returns the given comment from a GIF image, which does not have to be loaded into memory.

#### Prototype

```
int GUI_GIF_GetCommentEx(GUI_GET_DATA_FUNC * pfGetData,
                        void * p,
                        U8 * pBuffer,
                        int MaxSize,
                        int Index);
```

#### Parameters

| Parameter                 | Description  |
|---------------------------|--|
| <a href="#">pfGetData</a> | Pointer to a function which is called for getting data. For details about the GetData function, refer to <i>Getting data with the ...Ex() functions</i> on page 476. |
| <a href="#">p</a>         | Void pointer passed to the function pointed by <a href="#">pfGetData</a> .   |
| <a href="#">pBuffer</a>   | Pointer to a buffer to be filled with the comment.   |
| <a href="#">MaxSize</a>   | Size of the buffer.  |
| <a href="#">Index</a>     | Zero based index of comment to be returned.  |

#### Return value

= 0      on success  
 ≠ 0      on error.

#### Additional information

For details, refer to `GUI_GIF_GetComment()`.

### 5.4.3.4.1.9 GUI\_GIF\_GetImageInfo()

#### Description

Returns information about the given sub image of a GIF file, which has been loaded into memory.

#### Prototype

```
int GUI_GIF_GetImageInfo(const void          * pGIF,
                        U32                 NumBytes,
                        GUI_GIF_IMAGE_INFO * pInfo,
                        int                  Index);
```

#### Parameters

| Parameter             | Description  |
|-----------------------|--|
| <code>pGIF</code>     | Pointer to the start of the memory area in which the gif file resides.                       |
| <code>NumBytes</code> | Number of bytes of the gif file.   |
| <code>pInfo</code>    | Pointer to a <code>GUI_GIF_IMAGE_INFO</code> structure which will be filled by the function. |
| <code>Index</code>    | Zero based index of sub image.   |

#### Return value

= 0      on success  
 ≠ 0      on error.

#### Additional information

If an image needs be shown as a movie this function should be used to get the time the sub image should be visible and the next sub image should be shown. If the delay member is 0 the image should be visible for 1/10 second.

### 5.4.3.4.1.10 GUI\_GIF\_GetImageInfoEx()

#### Description

Returns information about the given sub image of a GIF file, which does not need to be loaded into memory.

#### Prototype

```
int GUI_GIF_GetImageInfoEx(GUI_GET_DATA_FUNC * pfGetData,
                           void * p,
                           GUI_GIF_IMAGE_INFO * pInfo,
                           int Index);
```

#### Parameters

| Parameter              | Description  |
|------------------------|--|
| <code>pfGetData</code> | Pointer to a function which is called for getting data. For details about the GetData function, refer to <i>Getting data with the ...Ex() functions</i> on page 476. |
| <code>p</code>         | Void pointer passed to the function pointed by <code>pfGetData</code> .  |
| <code>pInfo</code>     | Pointer to a GUI_GIF_IMAGE_INFO structure which will be filled by the function.  |
| <code>Index</code>     | Zero based index of sub image.   |

#### Return value

= 0      on success  
 ≠ 0      on error.

#### Additional information

For more details, refer to GUI\_GIF\_GetImageInfo().



### 5.4.3.4.1.11 GUI\_GIF\_GetInfo()

#### Description

Returns an information structure with information about the size and the number of sub images within the given GIF file, which has been loaded into memory.

#### Prototype

```
int GUI_GIF_GetInfo(const void      * pGIF,  
                   U32             NumBytes,  
                   GUI_GIF_INFO * pInfo);
```

#### Parameters

| Parameter             | Description   |
|-----------------------|---|
| <code>pGIF</code>     | Pointer to the start of the memory area in which the gif file resides.                  |
| <code>NumBytes</code> | Number of bytes of the gif file.  |
| <code>pInfo</code>    | Pointer to a <code>GUI_GIF_INFO</code> structure which will be filled by this function. |

#### Return value

= 0        on success  
≠ 0        on error.

### 5.4.3.4.1.12 GUI\_GIF\_GetInfoEx()

#### Description

Returns an information structure with information about the size and the number of sub images within the given GIF file, which does not need to be loaded into memory.

#### Prototype

```
int GUI_GIF_GetInfoEx(GUI_GET_DATA_FUNC * pfGetData,
                    void * p,
                    GUI_GIF_INFO * pInfo);
```

#### Parameters

| Parameter              | Description  |
|------------------------|--|
| <code>pfGetData</code> | Pointer to a function which is called for getting data. For details about the GetData function, refer to <i>Getting data with the ...Ex() functions</i> on page 476. |
| <code>p</code>         | Void pointer passed to the function pointed by <code>pfGetData</code> .  |
| <code>pInfo</code>     | Pointer to a GUI_GIF_INFO structure which will be filled by this function.   |

#### Return value

= 0      on success  
 ≠ 0      on error.

### 5.4.3.4.1.13 GUI\_GIF\_GetXSize()

#### Description

Returns the X-size of a specified GIF image, which has been loaded into memory.

#### Prototype

```
int GUI_GIF_GetXSize(const void * pGIF);
```

#### Parameters

| Parameter         | Description  |
|-------------------|--|
| <code>pGIF</code> | Pointer to the start of the memory area in which the gif file resides. |

#### Return value

X-size of the GIF image.

#### 5.4.3.4.1.14 GUI\_GIF\_GetXSizeEx()

##### Description

Returns the X-size of a specified GIF image, which does not need to be loaded into memory.

##### Prototype

```
int GUI_GIF_GetXSizeEx(GUI_GET_DATA_FUNC * pfGetData,  
                      void * p);
```

##### Parameters

| Parameter              | Description  |
|------------------------|--|
| <code>pfGetData</code> | Pointer to a function which is called for getting data. For details about the GetData function, refer to <i>Getting data with the ...Ex() functions</i> on page 476. |
| <code>p</code>         | Void pointer passed to the function pointed by <code>pfGetData</code> .  |

##### Return value

X-size of the GIF image.

#### 5.4.3.4.1.15 GUI\_GIF\_GetYSize()

##### Description

Returns the Y-size of a specified GIF image, which has been loaded into memory.

##### Prototype

```
int GUI_GIF_GetYSize(const void * pGIF);
```

##### Parameters

| Parameter         | Description  |
|-------------------|--|
| <code>pGIF</code> | Pointer to the start of the memory area in which the bmp file resides. |

##### Return value

Y-size of the GIF image.

#### 5.4.3.4.1.16 GUI\_GIF\_GetYSizeEx()

##### Description

Returns the Y-size of a specified GIF image, which does not need to be loaded into memory.

##### Prototype

```
int GUI_GIF_GetYSizeEx(GUI_GET_DATA_FUNC * pfGetData,  
                      void * p);
```

##### Parameters

| Parameter              | Description   |
|------------------------|---|
| <code>pfGetData</code> | Pointer to a function which is called for getting data. Detailed information about the Get-Data() function can be found under to <i>Getting data with the ...Ex() functions</i> on page 476 |
| <code>p</code>         | Void pointer passed to the function pointed by <code>pfGetData</code> .   |

##### Return value

Y-size of the GIF image.

### 5.4.3.4.2 Data structures

#### 5.4.3.4.2.1 GUI\_GIF\_IMAGE\_INFO

##### Description

Information about a sub-image in a GIF file.

##### Type definition

```
typedef struct {  
    int  xPos;  
    int  yPos;  
    int  xSize;  
    int  ySize;  
    int  Delay;  
} GUI_GIF_IMAGE_INFO;
```

##### Structure members

| Member             | Description   |
|--------------------|---|
| <code>xPos</code>  | X-position of the last drawn image.                         |
| <code>yPos</code>  | Y-position of the last drawn image.                         |
| <code>xSize</code> | X-size of the last drawn image.                             |
| <code>ySize</code> | Y-size of the last drawn image.                             |
| <code>Delay</code> | Time in 1/100 seconds the image should be shown in a movie. |

##### See also

- `GUI_GIF_GetImageInfo()`
- `GUI_GIF_GetImageInfoEx()`

### 5.4.3.4.2.2 GUI\_GIF\_INFO

#### Description

Information about a sub-image in a GIF file.

#### Type definition

```
typedef struct {  
    int  xSize;  
    int  ySize;  
    int  NumImages;  
} GUI_GIF_INFO;
```

#### Structure members

| Member                    | Description                       |
|---------------------------|-----------------------------------|
| <a href="#">xSize</a>     | Pixel size in X of the image.     |
| <a href="#">ySize</a>     | Pixel size in Y of the image.     |
| <a href="#">NumImages</a> | Number of sub-images in the file. |

#### See also

- [GUI\\_GIF\\_GetInfo\(\)](#)
- [GUI\\_GIF\\_GetInfoEx\(\)](#)



## 5.4.4 PNG file support

The PNG (Portable Network Graphics) format is an image format which offers lossless data compression and alpha blending by using a non-patented data compression method. Version 1.0 of the PNG specification has been released in 1996. Since the end of 2003 PNG is an international standard (ISO/IEC 15948). PNG support for emWin can be achieved by using the 'libpng' library from Glenn Randers-Pehrson, Guy Eric Schalnat and Andreas Dilger. An adapted version of this library ready to use with emWin is available [on our website](#). That library can be added to emWin in order to use the PNG API as explained later in this chapter.

### Licensing

The use of 'libpng' library is subject to a BSD style license and copyright notice in the file GUI\PNG\png.h of the downloadable library. The original version of the library is available for free under [www.libpng.org](http://www.libpng.org).

### 5.4.4.1 Converting a PNG file to C source

Under some circumstances it can be useful to add a PNG file as C file to the project. This can be done by exactly the same way as described before under *JPEG file support* on page 439. Further the Bitmap Converter is able to load PNG files and can convert them into C bitmap files.

### 5.4.4.2 Displaying PNG files

The graphic library first decodes the graphic information. If the image has to be drawn the decoding process takes considerable time. If a PNG file is used in a frequently called callback routine of the Window Manager, the decoding process can take a considerable amount of time. The calculation time can be reduced by the use of Memory Devices. The best way would be to draw the image first into a Memory Device. In this case the decompression would be executed only one time. For more information about Memory Devices, refer to the chapter *Memory Devices* on page 2626.

### 5.4.4.3 Memory usage

The PNG decompression uses approximately 21 KB of RAM for decompression independent of the image size and a size dependent amount of bytes. The RAM requirement can be calculated as follows:  $\text{Approx. RAM requirement} = (\text{xSize} + 1) * \text{ySize} * 4 + 54 \text{ KB}$

### 5.4.4.4 PNG API

The table below lists the available PNG file related routines in alphabetical order. Detailed function descriptions follow:

| Routine                              | Description  |
|--------------------------------------|--|
| <a href="#">GUI_PNG_Draw()</a>       | Draws the PNG file which has been loaded into memory.                        |
| <a href="#">GUI_PNG_DrawEx()</a>     | Draws the PNG file which does not need to be loaded into memory.             |
| <a href="#">GUI_PNG_GetXSize()</a>   | Returns the X-size of a bitmap loaded into memory.                           |
| <a href="#">GUI_PNG_GetXSizeEx()</a> | Returns the X-size of a bitmap which does not need to be loaded into memory. |
| <a href="#">GUI_PNG_GetYSize()</a>   | Returns the Y-size of a bitmap loaded into memory.                           |
| <a href="#">GUI_PNG_GetYSizeEx()</a> | Returns the Y-size of a bitmap which does not need to be loaded into memory. |

#### 5.4.4.4.1 GUI\_PNG\_Draw()

##### Description

Draws a png file, which has been loaded into memory, at a specified position in the current window.

##### Prototype

```
int GUI_PNG_Draw(const void * pFileData,  
                int      FileSize,  
                int      x0,  
                int      y0);
```

##### Parameters

| Parameter              | Description  |
|------------------------|--|
| <code>pFileData</code> | Pointer to the start of the memory area in which the png file resides. |
| <code>FileSize</code>  | Number of bytes of the png file.                                       |
| <code>x0</code>        | X-position of the upper left corner of the bitmap in the display.      |
| <code>y0</code>        | Y-position of the upper left corner of the bitmap in the display.      |

##### Return value

= 0        on success.

≠ 0        if the function fails. (The current implementation always returns 0).

##### Additional information

The Sample folder contains the example `2DGL_DrawPNG.c` which shows how to use the function.

### 5.4.4.4.2 GUI\_PNG\_DrawEx()

#### Description

Draws a png file, which does not have to be loaded into memory, at a specified position in the current window.

#### Prototype

```
int GUI_PNG_DrawEx(GUI_GET_DATA_FUNC * pfGetData,
                  void * p,
                  int x0,
                  int y0);
```

#### Parameters

| Parameter              | Description  |
|------------------------|--|
| <code>pfGetData</code> | Pointer to a function which is called for getting data. For details about the GetData function, refer to <i>Getting data with the ...Ex() functions</i> on page 476. |
| <code>p</code>         | Void pointer passed to the function pointed by <code>pfGetData</code> .  |
| <code>x0</code>        | X-position of the upper left corner of the bitmap in the display.  |
| <code>y0</code>        | Y-position of the upper left corner of the bitmap in the display.  |

#### Return value

= 0      on success.  
 ≠ 0      if the function fails.

#### Additional information

This function is used for drawing png if not enough RAM is available to load the whole file into memory. The PNG library then calls the function pointed by the parameter `pfGetData` to read the data.

The GetData function should return the number of available bytes. This could be less or equal the number of requested bytes. The function needs at least to return 1 new byte. Note that the PNG library internally allocates a buffer for the complete image. This can not be avoided by using this function.

### 5.4.4.4.3 GUI\_PNG\_GetXSize()

#### Description

Returns the X-size of a specified PNG image, which has been loaded into memory.

#### Prototype

```
int GUI_PNG_GetXSize(const void * pFileData,  
                    int      FileSize);
```

#### Parameters

| Parameter              | Description  |
|------------------------|--|
| <code>pFileData</code> | Pointer to the start of the memory area in which the png file resides. |
| <code>FileSize</code>  | Size of the file in bytes.   |

#### Return value

X-size of the PNG image.

#### 5.4.4.4 GUI\_PNG\_GetXSizeEx()

##### Description

Returns the X-size of a specified PNG image, which does not have to be loaded into memory.

##### Prototype

```
int GUI_PNG_GetXSizeEx(GUI_GET_DATA_FUNC * pfGetData,  
                      void * p);
```

##### Parameters

| Parameter              | Description  |
|------------------------|--|
| <code>pfGetData</code> | Pointer to a function which is called for getting data. For details about the GetData function, refer to <i>Getting data with the ...Ex() functions</i> on page 476. |
| <code>p</code>         | Void pointer passed to the function pointed by <code>pfGetData</code> .  |

##### Return value

X-size of the PNG image.

#### 5.4.4.4.5 GUI\_PNG\_GetYSize()

##### Description

Returns the Y-size of a specified PNG image, which has been loaded into memory.

##### Prototype

```
int GUI_PNG_GetYSize(const void * pFileData,  
                    int      FileSize);
```

##### Parameters

| Parameter              | Description  |
|------------------------|--|
| <code>pFileData</code> | Pointer to the start of the memory area in which the png file resides. |
| <code>FileSize</code>  | Size of the file in bytes.   |

##### Return value

Y-size of the PNG image.

#### 5.4.4.4.6 GUI\_PNG\_GetYSizeEx()

##### Description

Returns the Y-size of a specified PNG image, which does not have to be loaded into memory.

##### Prototype

```
int GUI_PNG_GetYSizeEx(GUI_GET_DATA_FUNC * pfGetData,  
                      void * p);
```

##### Parameters

| Parameter              | Description  |
|------------------------|--|
| <code>pfGetData</code> | Pointer to a function which is called for getting data. For details about the GetData function, refer to <i>Getting data with the ...Ex() functions</i> on page 476. |
| <code>p</code>         | Void pointer passed to the function pointed by <code>pfGetData</code> .  |

##### Return value

Y-size of the PNG image.

## 5.4.5 Getting data with the ...Ex() functions

As well as streamed bitmaps, using BMP, GIF, JPEG and PNG files also works without loading the whole image into RAM. For this case the *...Ex() functions* can be used. Common for all of these functions is the use of a *GetData* function. Please note that the *GetData* function has to work slightly different depending on the actual task it is used for. See table of parameters and examples below.

### Prototype of the 'GetData' function

```
int GUI_GET_DATA_FUNC(    void * p,
                        const U8 ** ppData,
                        unsigned NumBytes,
                        U32 Off);
```

### Parameters

| Parameter             | Description   |
|-----------------------|---|
| <code>p</code>        | Application defined void pointer.   |
| <code>ppData</code>   | <b>BMP, GIF &amp; JPEG:</b> The <i>GetData</i> function has to set the pointer to the location the requested data resides in.<br><b>Streamed bitmaps &amp; PNG:</b> The location the pointer points to has to be filled by the <i>GetData</i> function. |
| <code>NumBytes</code> | Number of requested bytes.  |
| <code>Off</code>      | Defines the offset to use for reading the source data.  |

### Additional information

*...Ex() functions* require the *GetData* function to fetch at least one pixel line of data. It is recommended to make sure that the *GetData* function is able to fetch at least one pixel line of the biggest image used by the application.

### Internal use of the function

In general the *GetData* function is called one time at the beginning to retrieve overhead information and, after this, several times to retrieve the actual image data.

### Return value

The number of bytes which were actually read. If the number of read bytes does not match, the drawing function will return immediately.

### Example

The following code excerpt shows how to implement a *GetData* function for usage with BMP, GIF and JPEG data:

```
int APP_GetData(void * p, const U8 ** ppData, unsigned NumBytes, U32 Off) {
    static char _acBuffer[0x200];
    HANDLE * phFile;
    DWORD NumBytesRead;
    phFile = (HANDLE *)p;
    //
    // Check buffer size
    //
    if (NumBytes > sizeof(acBuffer)) {
        NumBytes = sizeof(acBuffer);
    }
    //
    // Set file pointer to the required position
    //
    SetFilePointer(*phFile, Off, 0, FILE_BEGIN);
    //
```



```
// Read data into buffer
//
ReadFile(*phFile, acBuffer, NumBytes, &NumBytesRead, NULL);
//
// Set data pointer to the beginning of the buffer
//
*ppData = acBuffer;
//
// Return number of available bytes
//
return NumBytesRead;
}
```

### Example (PNG and streamed bitmap)

The following code excerpt shows how to implement a `GetData` function for usage with PNG and streamed bitmap data:

```
int APP_GetData(void * p, const U8 ** ppData, unsigned NumBytes, U32 Off) {
    HANDLE * phFile;
    DWORD   NumBytesRead;
    U8      * pData;
    pData = (U8 *)*ppData;
    phFile = (HANDLE *)p;
    //
    // Set file pointer to the required position
    //
    SetFilePointer(*phFile, Off, 0, FILE_BEGIN);
    //
    // Read data into buffer
    //
    ReadFile(*phFile, pData, NumBytes, &NumBytesRead, NULL);
    //
    // Return number of available bytes
    //
    return NumBytesRead;
}
```

## 5.5 Colors

emWin supports color displays, grayscale (monochrome with different intensities) and black/white displays. An existing emWin application can be used with different kinds of displays. If an existing application should be used with a new display only the display configuration (normally located in `LCDConf.c`) needs to be changed. To achieve this the application uses 'logical colors'. That logical color format is independent of the color (or better pixel-) format required for the display controller.



## 5.5.1 Color management

If an application uses a color for a drawing operation that color normally should be a 'logical color' containing 8 bits for each color channel and 8 bits for the alpha channel. The display controller normally requires a different format, called 'index value' in this document. 'Logical colors' are independent of the used hardware. The format of the 'index values' depend on the requirements of the display controller. Wherever emWin draws anything on the display it converts the 'logical color' used by the application into an 'index value' for the controller. That conversion is done automatically by the color conversion routines configured in the display configuration routine `LCD_X_Config()` which should set up the routines to be used. That could be done separately for each layer.

emWin supports different ways of color conversion:

### Fixed palette mode

Using a fixed palette mode is the most recommended way of color conversion. It sets up conversion routines for converting a color into an index value and vice versa. emWin provides a large set of predefined fixed palette modes explained later in this chapter.

### Application defined color conversion

If none of the predefined fixed palette modes match the requirements a custom color conversion could be used. That simply means custom defined routines for converting a color into an index value and vice versa. Details explained later in this chapter.

### Custom palette mode

If a display controller with a palette based color management is used, either one of the fixed palette modes could be used or a custom palette could be defined.

In case of using a custom palette emWin converts the logical colors by using an optimized version of the "least-square deviation search". It compares the color to display (the logical color) with all the available palette colors and uses the one that the LCD-metric considers closest. Please note that using a custom palette mode could degrade the performance. Details about how to use a custom palette explained later in this chapter.

## 5.5.2 Logical colors

A logical color contains 8 bits for each color component and 8 bits for the alpha channel. Since V5.30 emWin supports 2 logical color formats:

### Logical color format ABGR

| Alpha                               | Blue        | Green       | Red         |
|-------------------------------------|-------------|-------------|-------------|
| 0x00 - opaque<br>0xFF - transparent |             |             |             |
| DB31 - DB24                         | DB23 - DB16 | DB15 - DB08 | DB07 - DB00 |

For a long period of time the above format was the only supported logical color format. That implies that the used logical color format of all applications using emWin written within that period is also the same.

### Logical color format ARGB (default)

| Alpha                               | Red         | Green       | Blue        |
|-------------------------------------|-------------|-------------|-------------|
| 0x00 - transparent<br>0xFF - opaque |             |             |             |
| DB31 - DB24                         | DB23 - DB16 | DB15 - DB08 | DB07 - DB00 |

Because of more and more hardware platforms using a slightly different pixel format we decided to add the option of using ARGB as logical color format to be able to improve performance significantly under certain circumstances. Please note that the alpha definition of the ARGB format is also different to the ABGR format.

This format is the default setting since version 5.48 of emWin. To use the ABGR format add the following to your GUIConf.h:

```
#define GUI_USE_ARGB 0
```

## 5.5.3 Switching to ARGB

Using that logical color format could make sense if a display controller is used which supports exactly that color format as index value. In that case the performance could be improved significantly, for example when using an on chip LCD controller with hardware acceleration.

### 5.5.3.1 Configuration

In previous versions of emWin it was required to configure emWin to use the ARGB format. Since version 5.48 this format is the default and no changes to the GUIConf.h are required any longer.

Under certain circumstances it might be necessary to switch back to the old configuration. If this is necessary just add the following to your GUIConf.h:

```
#define GUI_USE_ARGB 0
```

### 5.5.3.2 Required changes in existing applications

When switching from ABGR to ARGB or vice versa some things have to be considered.

#### Colors

Wherever colors are defined as hexadecimal values in the application the values have to be changed or even better a conversion macro has to be used. The following table shows the use of the same color with ARGB, ABGR and conversion macro:

| File             | Description                               |
|------------------|---|
| ARGB             | GUI_SetColor(0xA02010);                   |
| ABGR             | GUI_SetColor(0xFF1020A0);                 |
| Conversion macro | GUI_SetColor(GUI_MAKE_COLOR(0xFF1020A0)); |

Of course all predefined color values will be changed automatically.

#### 32 bpp Memory devices

emWin contains a couple of functions to be used with 32 bpp memory devices only. Those functions expect a determined memory device format. When working in ABGR mode that format is GUICC\_8888. When switching to ARGB that format is GUICC\_M8888I.

#### DIB bitmaps

Palette based bitmaps created by the bitmap converter contains an array of palette colors. Example:

```
static GUI_CONST_STORAGE GUI_COLOR _Colors8x1[] = {
    0x000000, 0xC04040, 0x40C020, 0xC0A000,
    0x4020E0, 0xC040A0, 0x00FFFF, 0xFFFFFFFF
};
```

All existing bitmaps need to be changed:

```
static GUI_CONST_STORAGE GUI_COLOR _Colors8x1[] = {
    0xFF000000, 0xFF4040C0, 0xFF20C040, 0xFF00A0C0,
    0xFFE02040, 0xFFA040C0, 0xFFFFFFFF00, 0xFFFFFFFF
};
```

If an application contains a large number of bitmaps a better way would be to convert the bitmaps again with new settings for the bitmap converter.





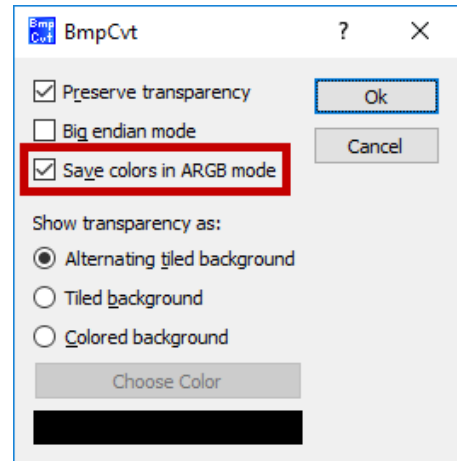



### 5.5.3.3 Configuring the BitmapConverter

In order to configure the bitmap converter to save colors directly in ARGB instead of ABGR the option available under **Options** → **Save colors in ARGB mode** should be activated.



## 5.5.4 Predefined colors

In addition to self-defined colors, some standard colors are predefined in emWin, as shown in the following table:

|                  |   |            |
|------------------|---|------------|
| GUI_BLUE         |    | 0xFF0000   |
| GUI_GREEN        |    | 0x00FF00   |
| GUI_RED          |    | 0x0000FF   |
| GUI_CYAN         |    | 0xFFFF00   |
| GUI_MAGENTA      |    | 0xFF00FF   |
| GUI_YELLOW       |    | 0x00FFFF   |
| GUI_LIGHTBLUE    |    | 0xFF8080   |
| GUI_LIGHTGREEN   |    | 0x80FF80   |
| GUI_LIGHTRED     |    | 0x8080FF   |
| GUI_LIGHTCYAN    |    | 0xFFFF80   |
| GUI_LIGHTMAGENTA |    | 0xFF80FF   |
| GUI_LIGHTYELLOW  |    | 0x80FFFF   |
| GUI_DARKBLUE     |    | 0x800000   |
| GUI_DARKGREEN    |    | 0x008000   |
| GUI_DARKRED      |    | 0x000080   |
| GUI_DARKCYAN     |    | 0x808000   |
| GUI_DARKMAGENTA  |    | 0x800080   |
| GUI_DARKYELLOW   |    | 0x008080   |
| GUI_WHITE        |   | 0xFFFFFFFF |
| GUI_LIGHTGRAY    |  | 0xD3D3D3   |
| GUI_GRAY         |  | 0x808080   |
| GUI_DARKGRAY     |  | 0x404040   |
| GUI_BLACK        |  | 0x000000   |
| GUI_BROWN        |  | 0x2A2AA5   |
| GUI_ORANGE       |  | 0x00A5FF   |

### Example

```
/* Set background color to magenta */
GUI_SetBkColor(GUI_MAGENTA);
GUI_Clear();
```

## 5.5.5 The color bar test routine

The color bar example program is used to show 13 color bars in the following order:

1. Black → Red
2. White → Red
3. Black → Green
4. White → Green
5. Black → Blue
6. White → Blue
7. Black → White
8. Black → Yellow
9. White → Yellow
10. Black → Cyan
11. White → Cyan
12. Black → Magenta
13. White → Magenta

This simple routine may be used on all displays in any color format. Of course, the results vary depending on the colors that can be displayed; the routine requires a display size of 320 \* 240 in order to show all colors. The routine is used to demonstrate the effect of the different color settings for displays. It may also be used by a test program to verify the functionality of the display, to check available colors and grayscales, as well as to correct color conversion. The screenshots are taken from the windows simulation and will look exactly like the actual output on your display if your settings and hardware are working properly. The routine is available as `COLOR_ShowColorBar.c` in the examples shipped with emWin.



## 5.5.6 Fixed palette modes

The following table lists the available fixed palette color modes and the necessary identifiers which need to be used when creating a driver- or a Memory Device. Detailed descriptions follow.

| Identifier     | No. available colors        | Mask  |
|----------------|-----------------------------|---|
| GUICC_1        | black and white             | 0x01 -> 00000001                                    |
| GUICC_2        | 4 grayscales                | 0x03 -> 00000011                                    |
| GUICC_4        | 16 grayscales               | 0x0F -> 00001111                                    |
| GUICC_5        | 32 grayscales               | 0x1F -> 00011111                                    |
| GUICC_16       | 16                          | 0x0F -> 00001111                                    |
| GUICC_1616I    | 16 + 4 bit alpha blending   | 0xFF -> 11111111                                    |
| GUICC_111      | 8                           | 0x07 -> 00000BGR                                    |
| GUICC_M111     | 8                           | 0x07 -> 00000RGB                                    |
| GUICC_222      | 64                          | 0x3F -> 00BBGGRR                                    |
| GUICC_M222     | 64                          | 0x3F -> 00RRGGBB                                    |
| GUICC_8        | 256 grayscales              | 0xFF -> 11111111                                    |
| GUICC_233      | 256                         | 0xFF -> BBGGRRRR                                    |
| GUICC_M233     | 256                         | 0xFF -> RRGGBBBB                                    |
| GUICC_323      | 256                         | 0xFF -> BBBGGRRR                                    |
| GUICC_M323     | 256                         | 0xFF -> RRRGGBBB                                    |
| GUICC_332      | 256                         | 0xFF -> BBBGGGRR                                    |
| GUICC_M332     | 256                         | 0xFF -> RRRGGGGB                                    |
| GUICC_444_12   | 4096                        | 0xFFFF -> 0000BBBBGGGGRRRR                          |
| GUICC_M444_12  | 4096                        | 0xFFFF -> 0000RRRRGGGGBBBB                          |
| GUICC_444_12_1 | 4096                        | 0xFFF0 -> BBBBGGGGRRRR0000                          |
| GUICC_444_16   | 4096                        | 0x7BDE -> 0BBBB0GGG0RRRR0                           |
| GUICC_M444_16  | 4096                        | 0x7BDE -> 0RRRR0GGG0BBBB0                           |
| GUICC_M4444I   | 4096 + 4 bit alpha blending | 0xFFFF -> AAAARRRRGGGGBBBB                          |
| GUICC_555      | 32768                       | 0x7FFF -> 0BBBBBGGGGRRRRR                           |
| GUICC_M555     | 32768                       | 0x7FFF -> 0RRRRRGGGGBBBBB                           |
| GUICC_M1555I   | 32768 + 1 bit transparency  | 0xFFFF -> TRRRRRGGGGBBBBB                           |
| GUICC_565      | 65536                       | 0xFFFF -> BBBBGGGGRRRRR                             |
| GUICC_M565     | 65536                       | 0xFFFF -> RRRRGGGGBBBBB                             |
| GUICC_666      | 262144                      | 0x0003FFFF -> BBBBGGGGRRRRR                         |
| GUICC_M666     | 262144                      | 0x0003FFFF -> RRRRGGGGBBBBB                         |
| GUICC_666_9    | 262144                      | 0x01FF01FF -> 000000BBBBBGGG000000GGRRRRR           |
| GUICC_M666_9   | 262144                      | 0x01FF01FF -> 000000RRRRRGGG000000GGBBBBB           |
| GUICC_666_18   | 262144                      | 0x00FCFCFC -> 0000000BBBBB0GGGGG00RRRRR00           |
| GUICC_M666_18  | 262144                      | 0x00FCFCFC -> 0000000RRRRR0GGGGG00BBBBB00           |
| GUICC_822216   | 256                         | 0xFF - Bits are not explicitly assigned to a color. |
| GUICC_84444    | 240                         | 0xFF - Bits are not explicitly assigned to a color. |

| Identifier   | No. available colors        | Mask   |
|--|-----------------------------|--|
| GUICC_8666   | 232                         | 0xFF - Bits are not explicitly assigned to a color.                          |
| GUICC_8666_1   | 233 (232 + transparency)    | 0xFF - Bits are not explicitly assigned to a color.                          |
| GUICC_88666I   | 232 + 8 bits alpha blending | 0xFFFF -> AAAAAAACCCCCC  |
| GUICC_888  | 16M                         | 0x0FFFFFFF -> BBBBGGGGRRRR   |
| GUICC_M888   | 16M                         | 0x0FFFFFFF -> RRRRRGGGGBBBB  |
| GUICC_8888   | 16M + 8 bit alpha blending  | 0xFFFFFFFF -> AAAAAABBBBBGGGGRRRR  |
| GUICC_8888I  | 16M + 8 bit alpha blending  | 0xFFFFFFFF -> AAAAAABBBBBGGGGRRRR  |
| GUICC_M8888  | 16M + 8 bit alpha blending  | 0xFFFFFFFF -> AAAAAARRRRRRGGGGBBBB   |
| GUICC_M8888I   | 16M + 8 bit alpha blending  | 0xFFFFFFFF -> AAAAAARRRRRRGGGGBBBB   |
| GUICC_0  | -                           | CUSTOM DEFINED FIXED PALETTE MODE  |
| GUICC_1_2<br>GUICC_1_4<br>GUICC_1_5<br>GUICC_1_8<br>GUICC_1_16<br>GUICC_1_24 | 2 (black and white)         | 0x0000001<br>0x0000003<br>0x000001F<br>0x00000FF<br>0x0000FFFF<br>0x00FFFFFF |

### Legend

- R** - Red
- G** - Green
- B** - Blue
- C** - Color (in case of no explicit bit assignment to colors)
- T** - Transparency bit
- A** - Alpha mask

### 5.5.7 Detailed fixed palette mode description

The following gives a detailed description of the available colors in each predefined fixed palette mode.

#### 5.5.7.1 GUICC\_1: 1 bpp (black and white)

Use of this mode is necessary for monochrome displays with 1 bit per pixel.



Available colors: 2

#### 5.5.7.2 GUICC\_2: 2 bpp (4 grayscales)

Use of this mode is necessary for monochrome displays with 2 bits per pixel.

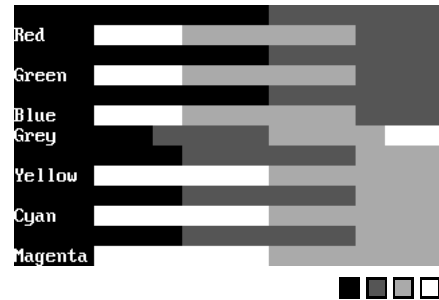

Available colors: 2 × 2 = 4

#### 5.5.7.3 GUICC\_4: 4 bpp (16 grayscales)

Use of this mode is necessary for monochrome displays with 4 bits per pixel.

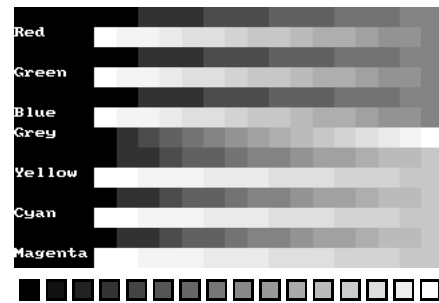

Available colors: 2 × 2 × 2 × 2 = 16

#### 5.5.7.4 GUICC\_5: 5 bpp (32 grayscales)

Use of this mode is necessary for monochrome displays with 5 bits per pixel.

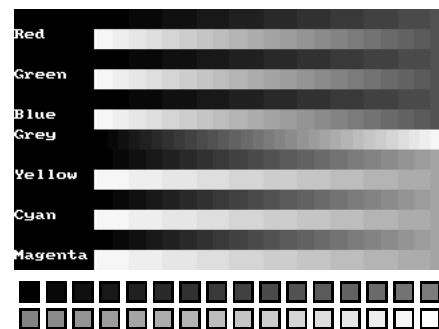

Available colors: 2 × 2 × 2 × 2 × 2 = 32

### 5.5.7.5 GUICC\_111: 3 bpp (2 levels per color)

Use this mode if the basic 8 colors are enough, if your hardware supports only one bit per pixel and color or if you do not have sufficient video memory for a higher color depth.



Available colors:  $2 \times 2 \times 2 = 8$   
 Color mask: BGR

### 5.5.7.6 GUICC\_M111: 3 bpp (2 levels per color), red and blue swapped

Use this mode if the basic 8 colors are enough, if your hardware supports only one bit per pixel and color or if you do not have sufficient video memory for a higher color depth. The available colors are the same as those in 111 mode.

Available colors:  $2 \times 2 \times 2 = 8$   
 Color mask: RGB

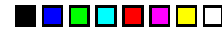

### 5.5.7.7 GUICC\_16: 4 bpp (16 colors)

This mode can be used if the basic 16 colors are enough, if the hardware supports only 4 bits per pixel or if you do not have sufficient video memory for a higher color depth.

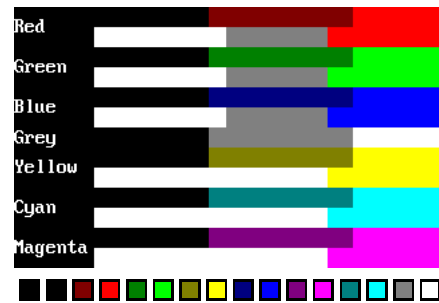

Available colors:  $2 \times 2 \times 2 \times 2 = 16$

### 5.5.7.8 GUICC\_1616I: 8 bpp (16 colors + 4 bits alpha mask)

Same colors as in GUICC\_16. The lower 4 bits contain the color and the upper 4 bits are used for alpha blending.

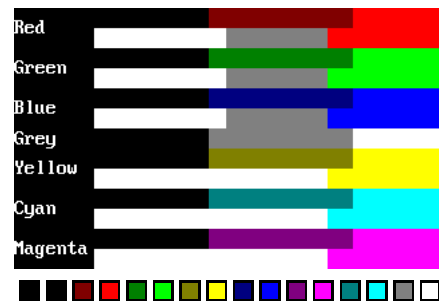

Available colors:  $2 \times 2 \times 2 \times 2 = 16$   
 Color mask: AAAACCCC  
 (AAAA = 0xF - opaque)  
 (AAAA = 0x0 - transparent)

### 5.5.7.9 GUICC\_222: 6 bpp (4 levels per color)

This mode is a good choice if your hardware does not have a palette for every individual color. 2 bits per pixel and color are reserved; usually 1 byte is used to store one pixel.



Available colors:  $4 \times 4 \times 4 = 64$

Color mask: BBGGRR

### 5.5.7.10 GUICC\_M222: 6 bpp (4 levels per color), red and blue swapped

This mode is a good choice if your hardware does not have a palette for every individual color. 2 bits per pixel and color are reserved; usually 1 byte is used to store one pixel. The available colors are the same as those in 222 mode.

Available colors:  $4 \times 4 \times 4 = 64$



Color mask: RRGGBB

### 5.5.7.11 GUICC\_8: 8 bpp (256 grayscales)

This mode uses 8 bpp for grayscales only. This is the smoothest possible grayscale mode.

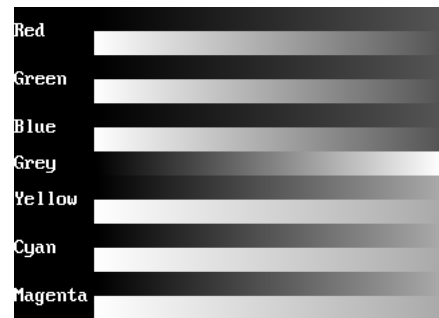

Available colors: 256 shades of gray.

### 5.5.7.12 GUICC\_233: 8 bpp

This mode supports 256 colors. 3 bits are used for the red and green components of the color and 2 bits for the blue component. As shown in the picture, the result is 8 grades for green and red and 4 grades for blue. We discourage the use of this mode because it do not contain real shades of gray.

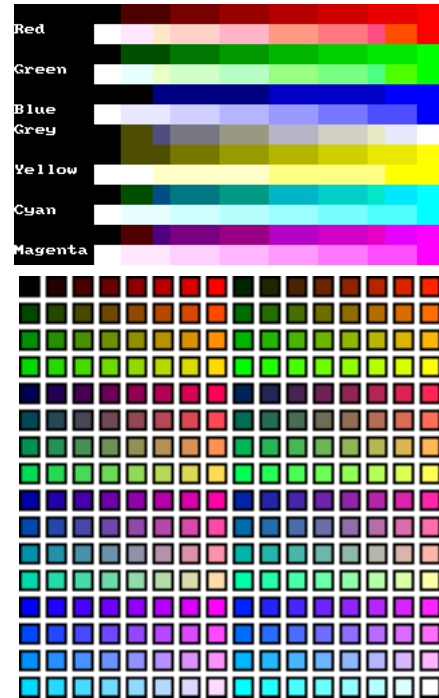

Available colors:  $4 \times 8 \times 8 = 256$

Color mask: BBGGRRR

### 5.5.7.13 GUICC\_M233: 8 bpp, red and blue swapped

This mode supports 256 colors. 3 bits are used for the red and green components of the color and 2 bits for the blue component. The result is 8 grades for green and blue and 4 grades for red. We discourage the use of this mode because it do not contain real shades of gray.



Available colors:  $4 \times 8 \times 8 = 256$

Color mask: RRGGBBB

### 5.5.7.14 GUICC\_323: 8 bpp

This mode supports 256 colors. 3 bits are used for the red and blue components of the color and 2 bits for the green component. As shown in the picture, the result is 8 grades for blue and red and 4 grades for green. We discourage the use of this mode because it do not contain real shades of gray.

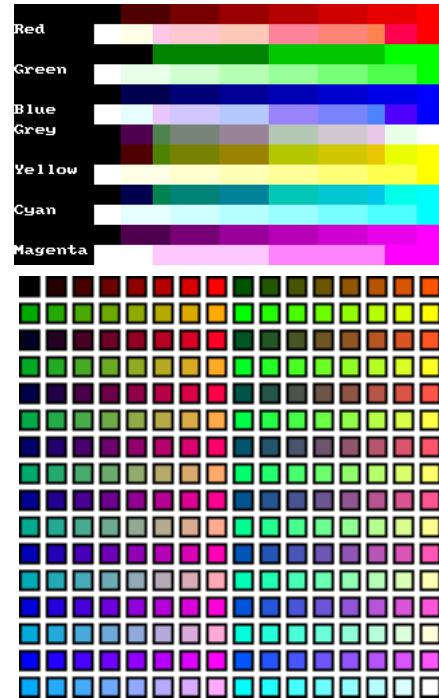

Available colors:  $8 \times 4 \times 8 = 256$

Color mask: BBBGRRR

### 5.5.7.15 GUICC\_M323: 8 bpp, red and blue swapped

This mode supports 256 colors. 3 bits are used for the red and blue components of the color and 2 bits for the green component. The available colors are the same as those in 323 mode. The result is 8 grades for red and blue and 4 grades for green. We discourage the use of this mode because it do not contain real shades of gray.

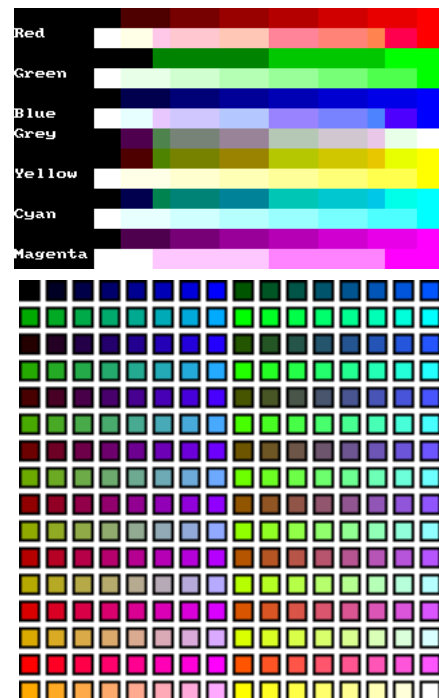

Available colors:  $8 \times 4 \times 8 = 256$

Color mask: RRRGBBBB

### 5.5.7.16 GUICC\_332: 8 bpp

This mode supports 256 colors. 3 bits are used for the blue and green components of the color and 2 bits for the red component. As shown in the picture, the result is 8 grades for green and blue and 4 grades for red. We discourage the use of this mode because it do not contain real shades of gray.

Available colors:  $8 \times 8 \times 4 = 256$

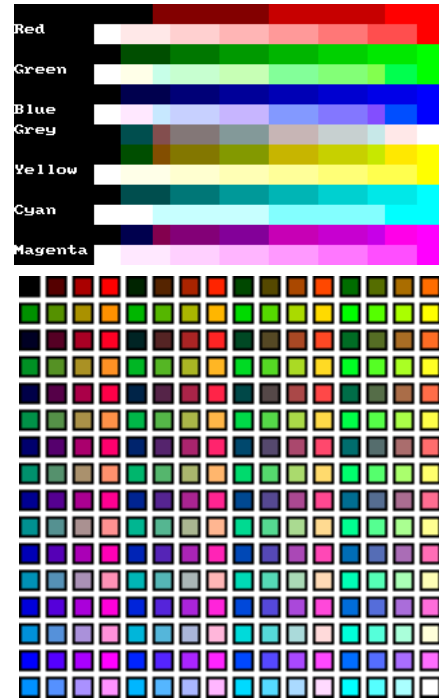

Color mask: BBBGGRR

### 5.5.7.17 GUICC\_M332: 8 bpp, red and blue swapped

This mode supports 256 colors. 3 bits are used for the red and green components of the color and 2 bits for the blue component. The result is 8 grades for red and green and only 4 grades for blue. We discourage the use of this mode because it do not contain real shades of gray.

Available colors:  $8 \times 8 \times 4 = 256$

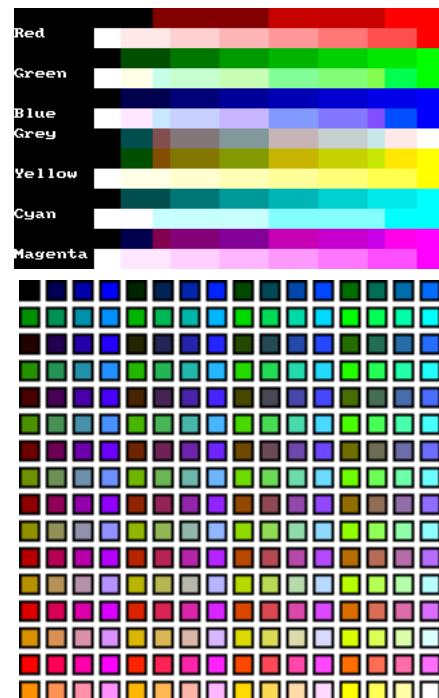

Color mask: RRRGGBB



### 5.5.7.18 GUICC\_444\_12:

The red, green and blue components are each 4 bits.

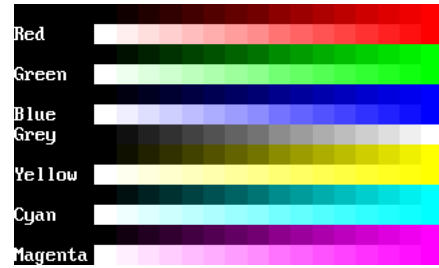

Available colors:  $16 \times 16 \times 16 = 4096$   
 Color mask: 0000BBBBGGGRRRR

### 5.5.7.19 GUICC\_444\_16:

The red, green and blue components are each 4 bits. One bit between the color components is not used. The available colors are the same as those in 444\_12 mode.



Available colors:  $16 \times 16 \times 16 = 4096$   
 Color mask: 0BBBB0GGGG0RRRR0

### 5.5.7.20 GUICC\_M444\_12: red and blue swapped

The red, green and blue components are each 4 bits. The available colors are the same as those in 444\_12 mode.



Available colors:  $16 \times 16 \times 16 = 4096$   
 Color mask: RRRRGGGGBBBB

### 5.5.7.21 GUICC\_M444\_16: red and blue swapped

The red, green and blue components are each 4 bits. One bit between the color components is not used. The available colors are the same as those in 444\_12 mode.



Available colors:  $16 \times 16 \times 16 = 4096$

Color mask: 0RRRR0GGGG0BBBB0

### 5.5.7.22 GUICC\_M444\_12\_1:

The red, green and blue components are each 4 bits. The lower 4 bits of the color mask are not used. The available colors are the same as those in 444\_12 mode.

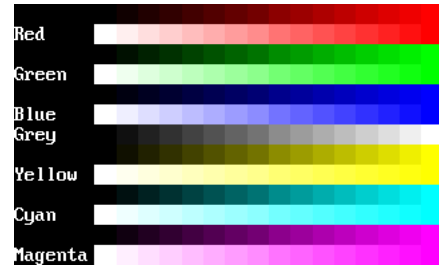

Available colors:  $16 \times 16 \times 16 = 4096$

Color mask: BBBBGGGGRRRR0000

### 5.5.7.23 GUICC\_M4444I: 12 bits colors + 4 bits alpha mask

The red, green and blue components are each 4 bits, the upper 4 bits are used for alpha blending.



Available colors:  $16 \times 16 \times 16 = 4096$

Color mask: AAAARRRRGGGGBBBB

(AAAA = 0xF - opaque)

(AAAA = 0x0 - transparent)

### 5.5.7.24 GUICC\_555: 15 bpp

Use of this mode is necessary for a display controller that supports RGB colors with a color-depth of 15 bpp. The red, green and blue components are each 5 bits.

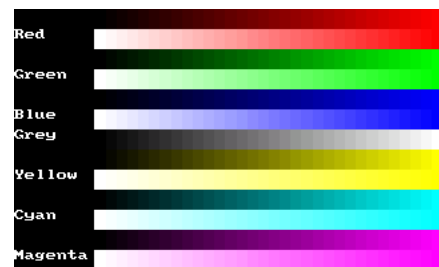

Available colors:  $32 \times 32 \times 32 = 32768$

Color mask: BBBBGGGGRRRRR

### 5.5.7.25 GUICC\_M555: 15 bpp, red and blue swapped

Use of this mode is necessary for a display controller that supports RGB colors with a color-depth of 15 bpp. The red, green and blue components are each 5 bits. The available colors are the same as those in 555 mode.

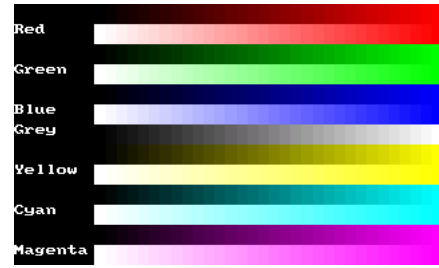

Available colors:  $32 \times 32 \times 32 = 32768$   
 Color mask: RRRRRGGGGBBBBB

### 5.5.7.26 GUICC\_M1555I: 15 bits colors + 1 bit transparency

The available colors are the same as those in 565 mode. The red, green and blue components are each 5 bits, the upper bit is used for transparency.

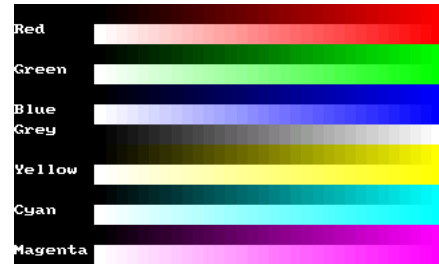

Available colors:  $32 \times 32 \times 32 = 32768$   
 Color mask: ARRRRRGGGGBBBBB  
 (A = 1 - opaque)  
 (A = 0 - transparent)

### 5.5.7.27 GUICC\_565: 16 bpp

Use of this mode is necessary for a display controller that supports RGB colors with a color-depth of 16 bpp. The red and the blue component is 5 bits and the green component is 6 bit.

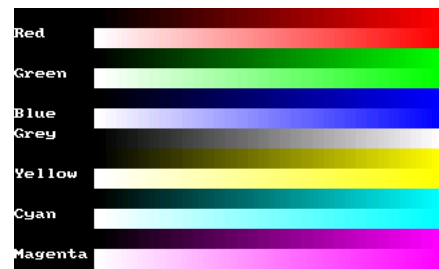

Available colors:  $32 \times 64 \times 32 = 65536$   
 Color mask: BBBBGGGGRRRRR

### 5.5.7.28 GUICC\_M565: 16 bpp, red and blue swapped

Use of this mode is necessary for a display controller that supports RGB colors with a color-depth of 16 bpp. The available colors are the same as those in 565 mode.

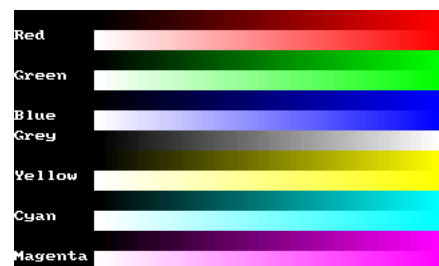

Available colors:  $32 \times 64 \times 32 = 65536$

Color mask: RRRRRGGGGGGBBBBB

### 5.5.7.29 GUICC\_666: 18 bpp

Use of this mode is necessary for a display controller that supports RGB colors with a color-depth of 18 bpp. The red, green and blue component is 6 bit.

Available colors:  $64 \times 64 \times 64 = 262144$  Color mask: BBBBGGGGGGRRRRR

### 5.5.7.30 GUICC\_M666: 18 bpp, red and blue swapped

Use of this mode is necessary for a display controller that supports RGB colors with a color-depth of 18 bpp. The red, green and the blue component is 6 bit.

Available colors:  $64 \times 64 \times 64 = 262144$  Color mask: RRRRRGGGGGGBBBBB

### 5.5.7.31 GUICC\_666\_9: 18 bpp

Use of this mode is necessary for a display controller that supports RGB colors with a color-depth of 18 bpp. The red, green and blue component is 6 bit.

Available colors:  $64 \times 64 \times 64 = 262144$

Color mask: 000000BBBBB-

BGGG000000GGRRRRR

### 5.5.7.32 GUICC\_M666\_9: 18 bpp, red and blue swapped

Use of this mode is necessary for a display controller that supports RGB colors with a color-depth of 18 bpp. The red, green and blue component is 6 bit.

Available colors:  $64 \times 64 \times 64 = 262144$  Color mask: 000000RRRRRRGGG000000GGG-  
BBBBB

### 5.5.7.33 GUICC\_666\_18: 18 bpp

Use of this mode is necessary for a display controller that supports RGB colors with a color-depth of 18 bpp. The red, green and blue component is 6 bit.

Available colors:  $64 \times 64 \times 64 = 262144$

Color mask: 0000000BBBBB00GGGGGG00R-

RRRRR00

### 5.5.7.34 GUICC\_M666\_18: 18 bpp, red and blue swapped

Use of this mode is necessary for a display controller that supports RGB colors with a color-depth of 18 bpp. The red, green and blue component is 6 bit.

Available colors:  $64 \times 64 \times 64 = 262144$  Color mask:  
0000000RRRRRR00GGGGGG00BBBBB00

### 5.5.7.35 GUICC\_822216: 8 bpp, 2 levels per color + 8 grayscales + 16 levels of alpha blending

This mode can be used with a programmable color lookup table (LUT), supporting a total of 256 possible colors and alpha blending support. It supports the 8 basic colors, 8 grayscales and 16 levels of alpha blending for each color / grayscale. With other words it can be used if only a few colors are required but more levels of alpha blending.

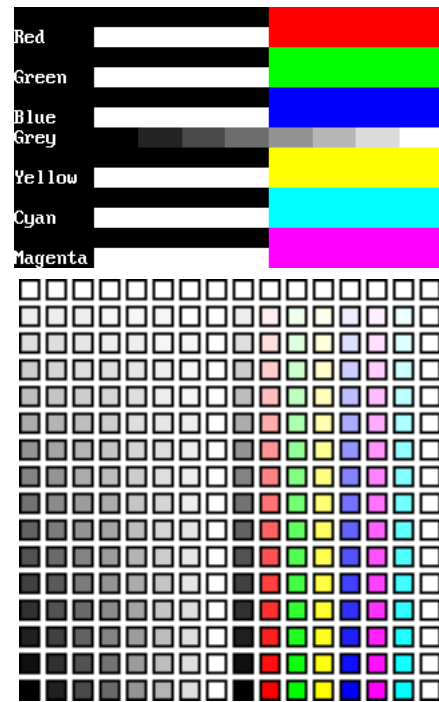

Available colors:  $(2 \times 2 \times 2 + 8) \times 16 = 256$

### 5.5.7.36 GUICC\_84444: 8 bpp, 4 levels per color + 16 grayscales + 4(3) levels of alpha blending

This mode can be used with a programmable color lookup table (LUT), supporting a total of 240 possible colors and alpha blending support. 4 levels of intensity are available for each color, in addition to 16 grayscales and 4 levels of alpha blending for each color / grayscale. With other words it can be used if only a few levels of alpha blending are required and different shades of colors.

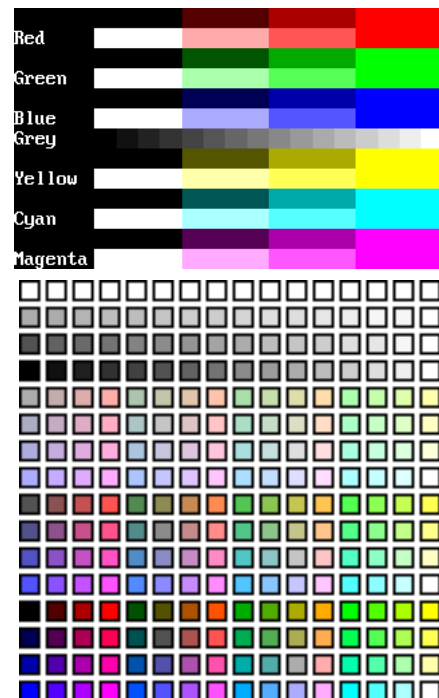

Available colors:  $(4 \times 4 \times 4 + 16) \times 3 = 240$

### 5.5.7.37 GUICC\_8666: 8bpp, 6 levels per color + 16 grayscales

This mode is most frequently used with a programmable color lookup table (LUT), supporting a total of 256 possible colors using a palette. The screenshot gives an idea of the available colors; this mode contains the best choice for general purpose applications. Six levels of intensity are available for each color, in addition to 16 grayscales.

Available colors:  $6 \times 6 \times 6 + 16 = 232$

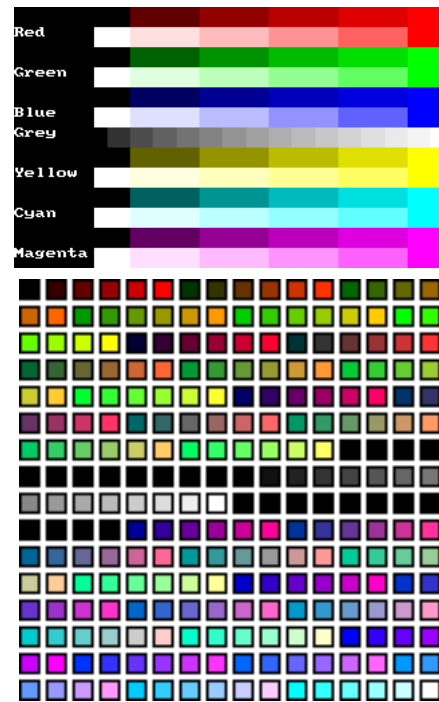

### 5.5.7.38 GUICC\_8666\_1: 8bpp, 6 levels per color + 16 grayscales + transparency

This mode is most frequently used with MultiLayer configurations and a programmable color lookup table (LUT), supporting a total of 256 possible colors using a palette. The difference between 8666 and 86661 is, that the first color indices of the 86661 mode are not used. So the color conversion routine GUI\_Color2Index() does never return 0 which is used for transparency.

Available colors:  $6 \times 6 \times 6 + 16 = 232$



### 5.5.7.39 GUICC\_886661: 16bpp - 8 bits color (6 levels per color + 16 grayscales) + 8 bits alpha blending

The available colors of this mode are exactly the same as described under GUICC\_8666. The upper 8 bits are used for alpha blending.

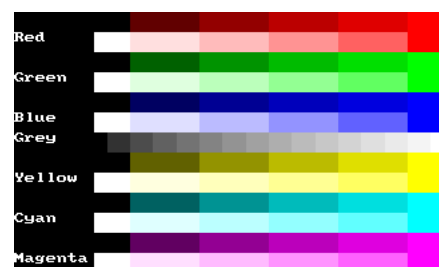

Color mask: AAAAAAAAAACCCCCCCC  
 (AAAAAAAA = 0xFF - opaque)  
 (AAAAAAAA = 0x00 - transparent)

#### 5.5.7.40 GUICC\_888: 24 bpp

Use of this mode is necessary for a display controller that supports RGB colors with a color depth of 24 bpp. The red, green and blue components are each 8 bits.



Available colors:  $256 \times 256 \times 256 = 16777216$   
 Color mask: BBBBGGGGGGRRRRRR

#### 5.5.7.41 GUICC\_M888: 24 bpp, red and blue swapped

Use of this mode is necessary for a display controller that supports RGB colors with a color depth of 24 bpp. The red, green and blue components are each 8 bits.



Available colors:  $256 \times 256 \times 256 = 16777216$   
 Color mask: RRRRRRRGGGGGGGBBBBBBB

#### 5.5.7.42 GUICC\_8888: 32 bpp

Use of this mode is necessary for a display controller that supports RGB colors with a color depth of 32 bpp, where the lower 3 bytes are used for the color components and the upper byte is used for alpha blending. The red, green, blue and alpha blending components are each 8 bits.

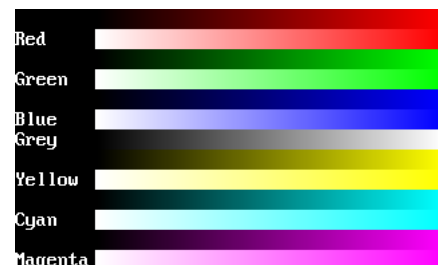

Available colors:  $256 \times 256 \times 256 = 16777216$   
 Color mask: AAAAAAAAAABBBBBBBGGGGGGGGRRRRRR

#### 5.5.7.43 GUICC\_8888I: 32 bpp

Use of this mode is necessary for a display controller that supports RGB colors with a color depth of 32 bpp, where the lower 3 bytes are used for the color components and the upper byte is used for alpha blending. The red, green, blue and alpha blending components are each 8 bits. The alpha component is inverted.

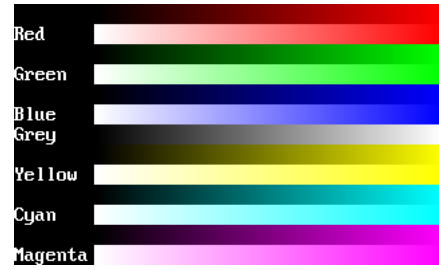

Color mask: AAAAAAAAAABBBBBBBBGGGGGGGRRRRRRRR  
 (AAAAAAAA = 0xFF - opaque)  
 (AAAAAAAA = 0x00 - transparent)

### 5.5.7.44 GUICC\_M8888: 32 bpp, red and blue swapped

Use of this mode is necessary for a display controller that supports RGB colors with a color depth of 32 bpp, where the lower 3 bytes are used for the color components and the upper byte is used for alpha blending. The red, green, blue and alpha blending components are each 8 bits.

Available colors: 256 × 256 × 256 = 16777216  
 Color mask: AAAAAAAAAARRRRRRRRGGGGGGGG-  
 BBBBBBBB

### 5.5.7.45 GUICC\_M8888I: 32 bpp, red and blue swapped

The color mode is exactly the same as described under GUICC\_M8888 with the difference, that alpha blending is inverted.

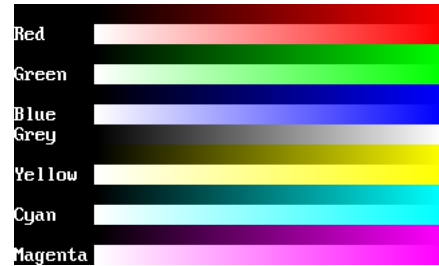

Color mask: AAAAAAAAAARRRRRRRRGGGGGGGGBBBBBBBB  
 (AAAAAAAA = 0xFF - opaque)  
 (AAAAAAAA = 0x00 - transparent)

### 5.5.7.46 GUICC\_0: Custom palette mode

How to use a custom palette mode is described under *Application defined color conversion* on page 501.

### 5.5.7.47 GUICC\_1\_2, GUICC\_1\_4, ... GUICC\_1\_24

These color conversion routines make it possible, to use display drivers which require a color depth of more than 1bpp, with emWin packages containing no support for colors or greyscales. The routines ensure that each color of the whole palette of possible colors will be converted into black or white.

#### Example

If the available emWin package does not contain color- or gray scale support and only a driver, which requires index values of 16 bits is available, GUICC\_1\_16 can be used. This color conversion scheme ensures that each color of the whole 16 bit palette will be converted into 0xFFFF (normally white) or 0x0000 (normally black).



## 5.5.8 Application defined color conversion

If none of the fixed palette modes matches the need of color conversion this mode makes it possible to use application defined color conversion routines. The purpose of these routines is converting an RGB value into an index value for the hardware and vice versa.

### Example of defining custom color conversion routines

The following example should explain how it works:

```
static unsigned _Color2Index_User(LCD_COLOR Color) {
    unsigned Index;
    /* Add code for converting the RGB value to an index value for the hardware */
    return Index;
}
static LCD_COLOR _Index2Color_User(unsigned Index) {
    LCD_COLOR Color;
    /* Add code for converting the index value into an RGB value */
    return Color;
}
static unsigned _GetIndexMask_User(void) {
    return 0xffff; /* Example for using 16 bits */
}
const LCD_API_COLOR_CONV LCD_API_ColorConv_User = {
    _Color2Index_User,
    _Index2Color_User,
    _GetIndexMask_User
};
```

The function `LCD_Color2Index_User` is called by `emWin` if a RGB value should be converted into an index value for the display controller whereas the function `LCD_Index2Color_User()` is called if an index value should be converted into a RGB value.

`LCD_GetIndexMask_User` should return a bit mask value, which has each bit set to 1 which is used by the display controller and unused bits should be set to 0. For example the index mask of `GUICC_44416` mode is `0BBBB0GGGG0RRRR0`, where 0 stands for unused bits. The bit mask for this mode is `0x7BDE`.

### Example of using custom color conversion routines

As described in the chapter *Configuration* on page 100 a pointer to an API table is required for creating the display driver device. As shown in the example above the API table consists of function pointers to the color conversion routines.

A good location for the API table and the color conversion routines is the configuration file `LCDConf.c` located in the `Config` folder. The routines can be used as follow in the function `LCD_X_Config` which is responsible to create the display driver device:

```
void LCD_X_Config(void) {
    //
    // Set display driver and color conversion for 1st layer
    //
    GUI_DEVICE_CreateAndLink(GUIDRV_LIN_16, &LCD_API_ColorConv_User, 0, 0);
    .
    .
    .
}
```

## 5.5.9 Custom palette mode

If none of the fixed palette modes fulfills the requirements of the application emWin is able to use a custom palette. A custom palette simply lists all the available colors in the same order as they are used by the hardware. This means that no matter what colors the display controller/display combination is able to display, emWin will be able to simulate them in the PC simulation and handle these colors correctly in the target system. Working with a custom palette requires a color depth  $\leq 8$  bpp.

A custom palette is typically configured during the initialization in the function `LCD_X_Config()` which is responsible for creating and configuring the display driver device. This requires setting the look-up table entries using the function `LCD_SetLUTEntryEx()` which in turn is called by the functions `LCD_SetLUT()` and `LCD_SetLUTEx()`. These functions are implemented in the custom palette mode module `GUICC_0.c`, but might require modification according to the used hardware. Detailed information can be found in the according function descriptions in the section *Look-up table API* on page 502.

### Example

The following example should show how a custom palette can be used. It passes the palette to the function:

```
static const LCD_COLOR _aColors_16[] = {
    0x000000, 0x0000FF, 0x00FF00, 0x00FFFF,
    0xFF0000, 0xFF00FF, 0xFFFF00, 0xFFFFFF,
    0x000000, 0x000080, 0x008000, 0x008080,
    0x800000, 0x800080, 0x808000, 0x808080,
};
static const LCD_PHYSPALETTE _aPalette_16 = {
    COUNTOF(_aColors_16), _aColors_16
};
void LCD_X_Config(void) {
    //
    // Set display driver and color conversion for 1st layer
    //
    .
    .
    .
    //
    // Set user palette data (only required if no fixed palette is used)
    //
    LCD_SetLUTEx(0, _aPalette_16);
}
```

### Elements of structure LCD\_PHYSPALETTE

| Data type         | Element     | Description   |
|-------------------|-------------|---|
| int               | NumEntries  | Number of entries to be stored in the look-up table.  |
| const LCD_COLOR * | pPalEntries | Pointer to an array of colors. The number of elements in this array has to match at least the value stored in NumEntries. |

### 5.5.9.1 Look-up table API

| Routine                          | Description  |
|----------------------------------|--|
| <code>LCD_SetLUT()</code>        | Sets the look-up table for the currently selected layer. |
| <code>LCD_SetLUTEx()</code>      | Sets the look-up table for the given layer.              |
| <code>LCD_SetLUTEntryEx()</code> | Sets one entry in the look-up table.                     |

### 5.5.9.1.1 LCD\_SetLUT()

#### Description

Sets the look-up table for the currently selected layer. This function is defined in the module `GUICC_0.c`. It may require modification according to the used hardware.

#### Prototype

```
void LCD_SetLUT(const LCD_PHYSPALETTE * pPalette);
```

#### Parameters

| Parameter             | Description  |
|-----------------------|--|
| <code>pPalette</code> | Pointer to a <code>LCD_PHYSPALETTE</code> structure. |

### 5.5.9.1.2 LCD\_SetLUTEx()

#### Description

Sets the look-up table for the given layer. This function is defined in the module `GUICC_0.c`. It may require modification according to the used hardware.

#### Prototype

```
void LCD_SetLUTEx(      int          LayerIndex,  
                     const LCD_PHYSPALETTE * pPalette);
```

#### Parameters

| Parameter               | Description   |
|-------------------------|---|
| <code>LayerIndex</code> | Index of the layer to set the look-up table for.      |
| <code>pPalette</code>   | Pointer to an <code>LCD_PHYSPALETTE</code> structure. |

### 5.5.9.1.3 LCD\_SetLUTEntryEx()

#### Description

Sets one entry in the look-up table.

#### Prototype

```
int LCD_SetLUTEntryEx(int      LayerIndex,  
                     U8      Pos,  
                     LCD_COLOR Color);
```

#### Parameters

| Parameter                  | Description   |
|----------------------------|---|
| <a href="#">LayerIndex</a> | Index of the layer the look-up entry has to be set for. |
| <a href="#">Pos</a>        | Position in the look-up table to use for this color.    |
| <a href="#">Color</a>      | 32-bit color value.                                     |

#### Return value

0        on success  
1        on error.

## 5.5.10 Gamma correction

Gamma correction can simply be achieved with custom color conversion routines. The trick is converting the colors twice. Please note that gamma correction does not work within the simulation.

### Color2Index - conversion

It should first make the gamma correction of the color to be converted. The result of the gamma correction then should be passed to the Color2Index-function of the desired fixed palette mode, whose result then should be returned.

### Index2Color - conversion

It should first convert the index to a color with the Color2Index-function of the desired fixed palette mode. The result then should be passed to the gamma correction routine whose result then should be returned.

### Example

The sample folder `LCDCConf\Common\` contains the sample file `LCDCConf_GammaCorrection.c`. It shows in detail how gamma correction can be used.

## 5.5.11 Color API

The following table lists the available color-related functions in alphabetical order within their respective categories. Detailed description of the routines can be found in the sections that follow.

| Basic functions                      |   |
|--------------------------------------|---|
| <code>GUI_GetBkColor()</code>        | Returns the current background color.                                 |
| <code>GUI_GetBkColorIndex()</code>   | Returns the index of the current background color.                    |
| <code>GUI_GetColor()</code>          | Returns the current foreground color.                                 |
| <code>GUI_GetColorIndex()</code>     | Returns the index of the current foreground color.                    |
| <code>GUI_GetDefaultColor()</code>   | Returns currently set default foreground color.                       |
| <code>GUI_GetDefaultBkColor()</code> | Returns currently set default background color.                       |
| <code>GUI_SetBkColor()</code>        | Sets the default background color.                                    |
| <code>GUI_SetBkColorIndex()</code>   | Sets the index of the current background color.                       |
| <code>GUI_SetColor()</code>          | Sets the current foreground color.                                    |
| <code>GUI_SetColorIndex()</code>     | Sets the index of the current foreground color.                       |
| <code>GUI_SetDefaultColor()</code>   | Sets the default foreground color.                                    |
| <code>GUI_SetDefaultBkColor()</code> | Sets the default background color.                                    |
| Conversion functions                 |   |
| <code>GUI_CalcColorDist()</code>     | Calculates the distance between 2 colors.                             |
| <code>GUI_CalcVisColorError()</code> | Calculates the distance to the next available color.                  |
| <code>GUI_Color2Index()</code>       | Returns the index of a specified RGB color value.                     |
| <code>GUI_Color2VisColor()</code>    | Returns the next available color of the system as an RGB color value. |
| <code>GUI_ColorIsAvailable()</code>  | Checks if the given color is available.                               |
| <code>GUI_Index2Color()</code>       | Returns the RGB color value of a specified index.                     |

## 5.5.11.1 Basic functions

### 5.5.11.1.1 GUI\_GetBkColor()

#### Description

Returns the current background color.

#### Prototype

```
GUI_COLOR GUI_GetBkColor(void);
```

#### Return value

The current background color.

### 5.5.11.1.2 GUI\_GetBkColorIndex()

#### Description

Returns the index of the current background color.

#### Prototype

```
int GUI_GetBkColorIndex(void);
```

#### Return value

The current background color index.



### 5.5.11.1.3 GUI\_GetColor()

#### Description

Returns the current foreground color.

#### Prototype

```
GUI_COLOR GUI_GetColor(void);
```

#### Return value

The current foreground color.

#### 5.5.11.1.4 GUI\_GetColorIndex()

##### Description

Returns the index of the current foreground color.

##### Prototype

```
int GUI_GetColorIndex(void);
```

##### Return value

The current foreground color index.

### 5.5.11.1.5 GUI\_GetDefaultColor()

#### Description

Returns currently set default foreground color.

#### Prototype

```
GUI_COLOR GUI_GetDefaultColor(void);
```

#### Return value

The default foreground color.

### 5.5.11.1.6 GUI\_GetDefaultBkColor()

#### Description

Returns currently set default background color.

#### Prototype

```
GUI_COLOR GUI_GetDefaultBkColor(void);
```

#### Return value

The current default background color.

### 5.5.11.1.7 GUI\_SetBkColor()

#### Description

Sets the default background color.

#### Prototype

```
void GUI_SetBkColor(GUI_COLOR color);
```

#### Parameters

| Parameter | Description                             |
|-----------|---|
| Color     | Color for background, 24-bit RGB value. |

### 5.5.11.1.8 GUI\_SetBkColorIndex()

#### Description

Sets the index of the current background color.

#### Prototype

```
void GUI_SetBkColorIndex(LCD_PIXELINDEX Index);
```

#### Parameters

| Parameter             | Description                                    |
|-----------------------|--|
| <a href="#">Index</a> | <a href="#">Index</a> of the color to be used. |

### 5.5.11.1.9 GUI\_SetColor()

#### Description

Sets the current foreground color.

#### Prototype

```
void GUI_SetColor(GUI_COLOR color);
```

#### Parameters

| Parameter | Description                             |
|-----------|---|
| Color     | Color for foreground, 24-bit RGB value. |

### 5.5.11.1.10 GUI\_SetColorIndex()

#### Description

Sets the index of the current foreground color.

#### Prototype

```
void GUI_SetColorIndex(LCD_PIXELINDEX Index);
```

#### Parameters

| Parameter             | Description                                    |
|-----------------------|--|
| <a href="#">Index</a> | <a href="#">Index</a> of the color to be used. |



### 5.5.11.1.11 GUI\_SetDefaultColor()

#### Description

Sets the default foreground color.

#### Prototype

```
void GUI_SetDefaultColor(GUI_COLOR Color);
```

#### Parameters

| Parameter | Description                             |
|-----------|---|
| Color     | Color for foreground, 24-bit RGB value. |

### 5.5.11.1.12 GUI\_SetDefaultBkColor()

#### Description

Sets the default background color.

#### Prototype

```
void GUI_SetDefaultBkColor(GUI_COLOR Color);
```

#### Parameters

| Parameter | Description                             |
|-----------|---|
| Color     | Color for foreground, 24-bit RGB value. |

## 5.5.11.2 Conversion functions

### 5.5.11.2.1 GUI\_CalcColorDist()

#### Description

Calculates the distance between 2 colors.

#### Prototype

```
U32 GUI_CalcColorDist(GUI_COLOR Color0,  
                     GUI_COLOR Color1);
```

#### Parameters

| Parameter           | Description                    |
|---------------------|--------------------------------|
| <code>Color0</code> | RGB value of the first color.  |
| <code>Color1</code> | RGB value of the second color. |

#### Return value

The distance between the two colors as described.

#### Additional information

The distance will be calculated by the sum of the square value from the distances of the red, green and the blue component:

$$\text{Difference} = (\text{Red1} - \text{Red0})^2 + (\text{Green1} - \text{Green0})^2 + (\text{Blue1} - \text{Blue0})^2$$

### 5.5.11.2.2 GUI\_CalcVisColorError()

#### Description

Calculates the distance to the next available color.

#### Prototype

```
U32 GUI_CalcVisColorError(GUI_COLOR color);
```

#### Parameters

| Parameter | Description                              |
|-----------|--|
| Color     | RGB value of the color to be calculated. |

#### Return value

The distance to the next available color.

#### Additional information

For details about the calculation, refer to `GUI_CalcColorDist()`.

### 5.5.11.2.3 GUI\_Color2Index()

#### Description

Returns the index of a specified RGB color value.

#### Prototype

```
int GUI_Color2Index(GUI_COLOR Color);
```

#### Parameters

| Parameter | Description                              |
|-----------|--|
| Color     | RGB value of the color to be calculated. |

#### Return value

The color index.

#### 5.5.11.2.4 GUI\_Color2VisColor()

##### Description

Returns the next available color of the system as an RGB color value.

##### Prototype

```
GUI_COLOR GUI_Color2VisColor(GUI_COLOR color);
```

##### Parameters

| Parameter | Description             |
|-----------|-------------------------|
| Color     | RGB value of the color. |

##### Return value

The RGB color value of the nearest available color.

### 5.5.11.2.5 GUI\_ColorIsAvailable()

#### Description

Checks if the given color is available.

#### Prototype

```
char GUI_ColorIsAvailable(GUI_COLOR color);
```

#### Parameters

| Parameter | Description             |
|-----------|-------------------------|
| Color     | RGB value of the color. |

#### Return value

1 if color is available  
0 if not.

### 5.5.11.2.6 GUI\_Index2Color()

#### Description

Returns the RGB color value of a specified index.

#### Prototype

```
GUI_COLOR GUI_Index2Color(int Index);
```

#### Parameters

| Parameter          | Description                                      |
|--------------------|--|
| <code>Index</code> | <code>Index</code> of the color to be converted. |

#### Return value

The RGB color value.



## 5.6 Fonts

This chapter describes the various methods of font support in emWin. The most common fonts are shipped with emWin as C font files. All of them contain the ASCII character set and most of them do also contain the characters included in the ISO 8859-1 character set. In fact, you will probably find that these fonts are fully sufficient for your application. For detailed information about the individual fonts, refer to *Standard fonts* on page 593.

emWin is compiled for 8-bit characters, allowing for a maximum of 256 different character codes out of which the first 32 are reserved as control characters. The availability of characters depends on the font. In order to display certain characters selecting an according font may be required. For accessing the complete 'Basic Multilingual Plane' (BMP, plane 0) of the Unicode codespace UTF8 decoding could be enabled. Details can be found in the chapter *Language Support* on page 739.

TrueType font files (TTF) can also be used directly. Support for those kind of fonts can be achieved by adding the FreeType library which comes with its own BSD style license. More details about TTF support and a download link can be found under *TrueType Font (TTF) format* on page 531.

### 5.6.1 Introduction

The first way of font support was the possibility to use C files with font definitions containing bitmaps with 1bpp pixel information for each character. This kind of font support was limited to use only the fonts which are compiled with the application. Over time, the font support has been improved regarding font quality, ROM requirement, performance, scalability and the ability to add further fonts at run time. In the meantime emWin fonts cover anti-aliasing, drawing of compound characters like required in Thai language, fonts located on external non addressable media and TrueType support. Except the TrueType font format, which is a vector font, all other kinds of fonts are bitmap fonts.

### 5.6.2 Requirements

Some characters are required within a font to measure certain font parameters such as the baseline or the height of a lower case character. The following characters are required:

| Character | Purpose   |
|-----------|---|
| <b>a</b>  | Measurement of the baseline.                        |
| <b>e</b>  | Measurement of the height of lower case characters. |
| <b>A</b>  | Measurement of the height of upper case characters. |

#### Using other measurement characters for emWin

The Font Converter allows to change the measurement characters being used for emWin fonts. To change the above default characters, go to "Options" → "Measurement characters..." within the tool.

#### TrueType fonts

TTF and BDF fonts created during runtime with the FreeType engine are using the following characters for measurements:

| Character | Purpose   |
|-----------|---|
| <b>g</b>  | Measurement of the height of lower case characters. |
| <b>M</b>  | Measurement of the height of upper case characters. |

The above characters can be changed using the routine `GUI_FT_SetMeasurementChars()`.

## 5.6.3 Font types

emWin supports different internal types of fonts defined by emWin and the commonly used TrueType fonts.

### Monospaced bitmap fonts

Each character of a monospaced bitmap font has the same size. In a proportional font each character has its own width, whereas in a monospaced font the width is defined only one time. The pixel information is saved with 1bpp and covers the whole character area.

### Proportional bitmap fonts

Each character of a proportional bitmap font has the same height and its own width. The pixel information is saved with 1bpp and covers the whole character area.

### Anti-aliased fonts with 2 bpp anti-aliasing information

Each character has the same height and its own width. The pixel information is saved with 2bpp anti-aliasing information and covers the whole character area.

### Anti-aliased fonts with 4 bpp anti-aliasing information

Each character has the same height and its own width. The pixel information is saved with 4bpp anti-aliasing information and covers the whole character area.

### Extended proportional bitmap fonts

Each character of an extended proportional bitmap font has its own height and its own width. The pixel information is saved with 1bpp and covers only the areas of the glyph bitmaps.

### Extended proportional bitmap fonts with 2 bpp anti-aliasing information

Each character has the same height and its own width. The pixel information is saved with 2bpp anti-aliasing information and covers only the areas of the glyph bitmaps.

### Extended proportional bitmap fonts with 4 bpp anti-aliasing information

Each character has the same height and its own width. The pixel information is saved with 4bpp anti-aliasing information and covers only the areas of the glyph bitmaps.

### Extended proportional bitmap fonts, framed

In case the background color is unknown at compile time, it might be preferable to use a framed font. A framed font is always drawn in transparent mode regardless of the current settings. The character pixels are drawn in the currently selected foreground color and the frame is drawn in background color. A good contrast between foreground and background color makes sure, that the text can be read on any background. Framed fonts are not suitable for compound characters like in the Thai language. They are also not suitable for Arabic fonts.

The picture below shows some framed text in front of a photo:



### Table of font types

The following table shows the difference between the font types. The pictures only show the pixel information saved in the font file:

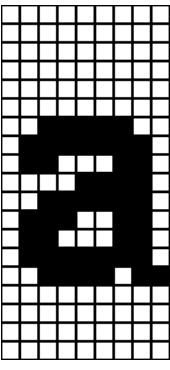
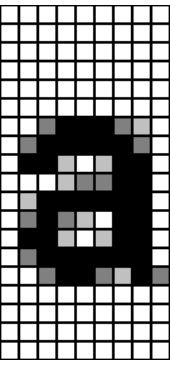
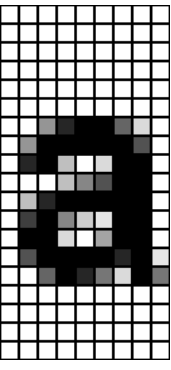
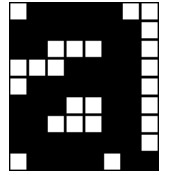
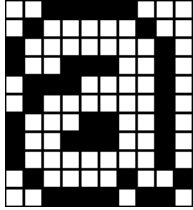
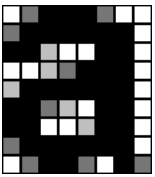
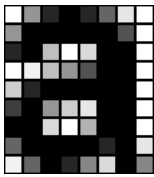
| Prop. bitmap font   | Prop. bitmap font, AA2  | Prop. bitmap font, AA4  | Ext. prop. bitmap font  | Ext. prop. bitmap font, framed  |
|---|---|---|---|---|
|  |  |  |   |  |
| <b>Ext. prop. bitmap font, AA2</b>  |   |   | <b>Ext. prop. bitmap font, AA4</b>  |   |
|  |   |   |  |   |

### TrueType vector fonts

The TrueType font support of emWin means support for the TrueType font file format described later in this chapter.

## 5.6.4 Font formats

The following explains the differences between the supported font formats, when to use them and what is required to be able to use them.

### 5.6.4.1 C file format

This is the most common way of using fonts. When using fonts in form of C files, we recommend compiling all available fonts and linking them as library modules or putting all of the font object files in a library which you can link with your application. This way you can be sure that only the fonts which are needed by your application are actually linked. The Font Converter may be used to create additional fonts.

#### When to use

This format should be used if the fonts are known at compile time and if there is enough addressable memory available for the font data.

#### Requirements

In order to be able to use a font C file in your application, the following requirements must be met:

- The font file is in a form compatible with emWin as C file, object file or library.
- The font file is linked with your application.
- The font declaration is contained in the application.

#### Format description

A font C file contains at first the pixel information of all characters included by the font. It is followed by a character information table with size information about each character. This table is followed by range information structures for each contiguous area of characters contained in the font file, whereas each structure points to the next one. Note that this method can enlarge a font file a lot if using many separate characters. After the range information structures a `GUI_FONT` structure follows with the main information like type, pixel size and so on of the font.

### 5.6.4.2 System Independent Font (SIF) format

System independent fonts are binary data blocks containing the font information. The Font Converter can be used to create system independent fonts. This tool is not part of the basic package. A short description follows later in this chapter.

#### When to use

This format should be used if the fonts are not known at compile time and if there is enough addressable memory available for the font data.

#### Requirements

In order to be able to use a SIF font file in your application, it is required that the whole file reside in addressable memory (ROM or RAM).

#### Format description

The structure of a SIF file is nearly the same as of a C file. It contains the same information in binary format. The sequence of the file components is vice versa: General font information followed by range information structures, character information table and at least pixel information of all characters.

### 5.6.4.3 External Bitmap Font (XBF) format

As well as SIF fonts XBF fonts are binary data blocks containing the font information and the Font Converter can be used to create XBF files. The Font Converter is not part of the emWin basic package. Details on how to create external bitmap fonts can be found in the chapter *Font Converter* on page 2832.

#### Advantages

Contrary to other fonts, XBF fonts do not have to reside in memory when they are used, whereas all other kinds of emWin fonts need to reside completely in memory. The XBF font file can remain on any external media while it is used. Data access is done by a `GetData` callback function. The advantage of XBF fonts is that it is possible to use very large fonts on systems with little memory.

XBF fonts offer a performance advantage when using fonts including lots of characters which do not follow each other directly in sequence. This kind of character set would cause the Font Converter to create a C file font containing many `GUI_FONT_PROP` structures having a pointer to the according next one. The more `GUI_FONT_PROP` structures exist in a font the longer it might take to display a character. XBF fonts just use a memory offset so each character can be found in the same amount of time.

#### When to use

This format should be used if there is not enough addressable memory available for the font data and if there is any kind of external media available for storing the fonts.

#### Requirements

In order to be able to use a XBF font in your application, a `GetData` callback function is required which is responsible for getting font data.

#### Format description

This format differs in general from SIF and C file format. At first it contains a small block of general font information including the lowest character code and the highest character code. It is followed by an access table containing offset and data size information for each character between lowest and highest character code. If a character does not exist, this information is zero for the according character. The access table is followed by the character information of all characters containing pixel data and character size information.

#### File content

```
(all values LSB):
Header (18 Bytes)
  4 Bytes ID (0x47, 0x55, 0x49, 0x58, "GUIX")
  16 Bits ySize of font
  16 Bits yDist of font, to be used for cursor increment
  16 Bits Baseline position from top
  16 Bits Height in pixels of lowercase characters
  16 Bits Height in pixels of capital characters
  16 Bits First codepoint in access table
  16 Bits Last codepoint in access table
Character Access table (6 Bytes for each entry)
  32 Bits Position of bitmap information in file (0 means character is not
  available)
  16 Bits Size of bitmap information
Bitmap Information (Extended font format)
  12 Bytes header:
    16 Bits X-distance in pixels to be used for cursor increment
    16 Bits X-size of bitmap
    16 Bits Y-size of bitmap
    16 Bits X-position of bitmap
    16 Bits Y-position of bitmap
    16 Bits Bytes per line of bitmap
  Bitmap (Size - 12 bytes)
```

```

Bitmap Information (Standard font format)
  4 Bytes header:
    16 Bits X-size of bitmap
    16 Bits Y-size of bitmap
  Bitmap (Size - 4 bytes)

```

#### 5.6.4.4 iType and iTypeSpark font engine support

Since version V5.20 emWin supports using the iType® font engine, since V5.30 it also supports the iTypeSpark® engine. The iType® and iTypeSpark® font engines are font rendering subsystems developed by Monotype Imaging. They offer a host of advanced capabilities including font linking, font management and discovery, support for various industry standards and font formats in a small memory footprint. iType® and iTypeSpark® can be implemented into various platforms. Based on OpenType®, TrueType® and PostScript® font formats and packaged as ANSI C code for broad, flexible integration, iType® meets stringent size requirements for any applications, including those that support East Asian languages requiring thousands of characters. The glue code to be able to use the those font engines is freely available under the following links:

- [www.segger.com/downloads/emwin/emWin\\_iType](http://www.segger.com/downloads/emwin/emWin_iType)
- [www.segger.com/downloads/emwin/emWin\\_iTypeSpark](http://www.segger.com/downloads/emwin/emWin_iTypeSpark)

#### Screenshot

*Italic text*  
**Regular bold italic text**  
**Regular bold text**  
**Filled outline**  
 Unfilled outline  
 Embossed text  
 Engraved text  
**Shadow text**  
**Glow text**

#### Licensing

The emWin library by SEGGER does not provide the Monotype® font engines itself. It provides only the glue code required to be able to use the iType® or the iTypeSpark® library. Please contact Monotype Imaging under [monotypeimaging.com](http://monotypeimaging.com) for a license request if required.

#### When to use

This format could be used if high quality fonts need to be scalable at run-time and/or advanced font effects are required.

#### Requirements

In general the requirements are similar to the requirements of the true type font support described on the next page. For detailed information about requirements and performance please also contact Monotype Imaging under [monotypeimaging.com](http://monotypeimaging.com).

### 5.6.4.5 TrueType Font (TTF) format

The functionality of emWin can be enhanced by making use of TrueType fonts. TrueType is an outline font standard developed by Apple Computer. It offers font developers a high degree of control over how their fonts are displayed at various font heights. Contrary to bitmap fonts which are based on bitmaps for each character, TrueType fonts are based on vector graphics. The advantage of the vector representation is the loss-free scalability.

This implies that each character first needs to be rasterized into a bitmap before it is drawn. To avoid rasterization each time a character is drawn the bitmap data normally is cached by the font engine. This requires a fast CPU and enough RAM. TTF support for emWin can be achieved by using the FreeType font library from David Turner, Robert Wilhelm and Werner Lemberg which is not part of emWin. An adapted version of this library ready to use with emWin is available [on our website](#). That library can be added to emWin in order to use the TTF API as explained later in this chapter.

#### Licensing

The use of FreeType font library is subject to a BSD style license with credit clause ([freetype.org](#)) also included in `GUI\TrueType\FTL.txt` of the zip file. The original version of the library is available for free under [freetype.org](#).

#### When to use

This format should be used if fonts need to be scalable at run-time.

#### Requirements

- **CPU:** TTF support works only on 32 bit CPUs. Our definition of a 32bit CPU: `sizeof(int) = 4`.
- **ROM:** The ROM requirement of the TTF engine is approx. 250K. The exact size depends on the CPU, the compiler and the optimization level of the compiler.
- **RAM:** The RAM requirement of the library depends a lot on the used fonts. The basic RAM requirement of the TTF engine is approx. 50K. When creating a GUI font with `GUI_TTF_CreateFont()` the font engine loads all font tables defined in the TTF file required to generate the characters. The table sizes varies a lot between the fonts. The additional required amount of RAM for creating a font can be between a few KB up to more than 1MB. For typical fonts 80-300 KB are required. It depends on the used font file how much RAM is required. At least the TTF engine requires a bitmap cache. Per default the engine uses 200K for the cache. This should be enough for most applications. The TTF engine allocates its memory via the non-emWin functions `malloc()` and `free()`. It must be made sure that these functions work before using the TTF engine.

#### Format description

For details about the TTF format, refer to the information available under [apple.com](#). It is also possible to display some fonts in the OTF format but this is not guaranteed. If a font is available in the TTF format it should be used instead of the OTF font.

### 5.6.4.6 Glyph Bitmap Distribution Format (BDF)

The Glyph Bitmap Distribution Format is a bitmap based font format developed by Adobe. The content of BDF files is intended to be readable for humans as well as computers.

Since it is a bitmap based format, fonts have a fixed size and cannot be scaled. The glyph bitmaps have a color depth of 1bpp, thus BDF fonts do not support anti-aliasing.

BDF support for emWin can be achieved by using the FreeType font library from David Turner, Robert Wilhelm and Werner Lemberg which is not part of emWin. An adapted version of this library ready to use with emWin is available [on our website](#). That library can be added to emWin in order to use the BDF API as explained later in this chapter.

Unlike with TTF fonts, the FreeType cache is not used for displaying BDF fonts, since the format is based on bitmaps instead of outlines.

#### Licensing

The use of FreeType font library is subject to a BSD style license with credit clause ([freetype.org](http://freetype.org)) also included in GUI\TrueType\FTL.txt of the zip file. The original version of the library is available for free under [freetype.org](http://freetype.org).

#### When to use

Since BDF is an old format and emWin already provides other bitmap based formats, it should only really be used e.g. when BDF fonts have been licensed previously and are intended to still be used.

#### Format description

For further details about the BDF format, refer to the [specification published by Adobe](#).



## 5.6.5 Converting a TTF file to C source

Under some circumstances it can be useful to add a TTF file as C file to the project, for example if no file system is available. This can be done by using the tool `Bin2C.exe` shipped with emWin. It can be found in the `Tools` subfolder. It converts the given binary file (in this case the TTF file) to a C file.

## 5.6.6 Declaring custom fonts

The most recommended way of declaring the prototypes of custom fonts is to put them into an application defined header file. This should be included from each application source file which uses these fonts. It could look like the following example:

```
#include "GUI.h"
extern GUI_CONST_STORAGE GUI_FONT GUI_FontApp1;
extern GUI_CONST_STORAGE GUI_FONT GUI_FontApp2;
```

Note that this kind of declaring prototypes does not work if the fonts should be used with emWin configuration macros like `BUTTON_FONT_DEFAULT` or similar. In this case the fonts need to be declared in the configuration file `GUIConf.h`. The declaration in this case can look like the following example:

```
typedef struct GUI_FONT GUI_FONT;

extern const GUI_FONT GUI_FontApp1;

#define BUTTON_FONT_DEFAULT &GUI_FontApp1
#define EDIT_FONT_DEFAULT &GUI_FontApp1
```

The `typedef` is required because the structure `GUI_FONT` has not been defined at the early point where `GUIConf.h` is included by emWin.

## 5.6.7 Selecting a font

emWin offers different fonts, one of which is always selected. This selection can be changed by calling the function `GUI_SetFont()` or one of the `GUI_XXX_CreateFont()` functions, which select the font to use for all text output to follow for the current task.

If no font has been selected by your application, the default font is used. This default is configured in `GUIConf.h` and can be changed. You should make sure that the default font is one that you are actually using in your application because the default font will be linked with your application and will therefore use up ROM memory.

## 5.6.8 Font API

The table below lists the available font-related routines in alphabetical order within their respective categories. Detailed descriptions can be found in the following sections.

### Functions

| Routine                                 | Description   |
|---|---|
| SIF file related font functions         |   |
| <code>GUI_SIF_CreateFont()</code>       | Sets the font to be used by passing a pointer to system independent font data.  |
| <code>GUI_SIF_DeleteFont()</code>       | Deletes a font created by <code>GUI_SIF_CreateFont()</code> .   |
| TTF file related font functions         |   |
| <code>GUI_TTF_CreateFont()</code>       | Creates and selects an emWin font by using a TTF font file.   |
| <code>GUI_TTF_CreateFontAA()</code>     | Creates and selects an antialiased emWin font by using a TTF font file.   |
| <code>GUI_TTF_EmboldenFont()</code>     | Renders the given TTF font as bold.   |
| <code>GUI_TTF_EmboldenFontEx()</code>   | Renders the given TTF font as bold.   |
| <code>GUI_TTF_GetFamilyName()</code>    | The function returns the font family name defined in the font file.   |
| <code>GUI_TTF_GetStyleName()</code>     | The function returns the style name (bold, regular, ...) defined in the font file.  |
| <code>GUI_TTF_ObliqueFont()</code>      | Renders the given TTF font as oblique.  |
| <code>GUI_TTF_ObliqueFontEx()</code>    | Renders the given TTF font as oblique.  |
| XBF file related font functions         |   |
| <code>GUI_XBF_CreateFont()</code>       | Creates and selects a font by passing a pointer to a callback function, which is responsible for getting data from the XBF font file. |
| <code>GUI_XBF_DeleteFont()</code>       | Deletes an XBF font pointed by the parameter <code>pFont</code> .   |
| BDF file related font functions         |   |
| <code>GUI_BDF_CreateFont()</code>       | Creates and selects an emWin font by using a BDF font file.   |
| <code>GUI_BDF_DeleteFont()</code>       | Frees all allocated memory for an emWin font created from a BDF font file.  |
| <code>GUI_BDF_EmboldenFont()</code>     | Renders the given BDF font as bold.   |
| <code>GUI_BDF_EmboldenFontEx()</code>   | Renders the given BDF font as bold.   |
| <code>GUI_BDF_GetFamilyName()</code>    | The function returns the font family name defined in the font file.   |
| <code>GUI_BDF_GetStyleName()</code>     | The function returns the style name (bold, regular, ...) defined in the font file.  |
| <code>GUI_BDF_SetLetterSpacing()</code> | Sets a spacing that is added/subtracted to each letter of the font.   |
| FreeType related font functions         |   |
| <code>GUI_FT_DestroyCache()</code>      | This function frees all memory allocated by the FreeType cache system and destroys the cache.   |
| <code>GUI_FT_Done()</code>              | This function frees all memory allocated by the FreeType engine and its internal cache system.  |

| Routine                                   | Description   |
|---|---|
| <code>GUI_FT_GetMeasurementChars()</code> | Returns the characters that are used for measuring the font metrics of newly created TTF and BDF fonts.   |
| <code>GUI_FT_SetCacheSize()</code>        | Sets the size parameters used to create the cache on the first call of <code>GUI_TTF_CreateFont()</code> or <code>GUI_BDF_CreateFont()</code> . |
| <code>GUI_FT_SetMeasurementChars()</code> | Sets the characters that are used for measuring the font metrics of newly created TTF and BDF fonts.  |
| <b>Common font-related functions</b>      |   |
| <code>GUI_GetCharDistX()</code>           | Returns the width in pixels (X-size) used to display a specified character in the currently selected font.                                      |
| <code>GUI_GetDefaultFont()</code>         | Returns the default currently set default font.   |
| <code>GUI_GetFallbackFont()</code>        | Returns a font which contains the given character.  |
| <code>GUI_GetFont()</code>                | Returns a pointer to the currently selected font.   |
| <code>GUI_GetFontDistY()</code>           | Returns the Y-spacing of the currently selected font.   |
| <code>GUI_GetFontInfo()</code>            | Calculates a pointer to a <code>GUI_FONTINFO</code> structure of a particular font.   |
| <code>GUI_GetFontSizeY()</code>           | Returns the height in pixels (Y-size) of the currently selected font.   |
| <code>GUI_GetLeadingBlankCols()</code>    | Returns the number of leading blank pixel columns in the currently selected font for the given character.                                       |
| <code>GUI_GetLeadingBlankRows()</code>    | Returns the number of leading blank pixel rows in the currently selected font for the given character.  |
| <code>GUI_GetStringDistX()</code>         | Returns the X-size used to display a specified string in the currently selected font.   |
| <code>GUI_GetStringDistXEx()</code>       | Returns the X-size used to display a number of characters of a string in the currently selected font.   |
| <code>GUI_GetTextExtend()</code>          | Calculates the text rectangle for drawing the given string.   |
| <code>GUI_GetTrailingBlankCols()</code>   | Returns the number of trailing blank pixel columns in the currently selected font for the given character.                                      |
| <code>GUI_GetTrailingBlankRows()</code>   | Returns the number of leading blank pixel rows in the currently selected font for the given character.  |
| <code>GUI_GetYDistOfFont()</code>         | Returns the Y-spacing of a particular font.   |
| <code>GUI_GetYSizeOfFont()</code>         | Returns the Y-size of a particular font.  |
| <code>GUI_IsInFont()</code>               | Evaluates whether a particular font contains a specified character or not.  |
| <code>GUI_SetDefaultFont()</code>         | Sets the font to be used by default for text output.  |
| <code>GUI_SetFallbackFont()</code>        | Sets a fallback font which is used if the default font does not contain the required characters.  |
| <code>GUI_SetFont()</code>                | Sets the font to be used for text output.   |

| Routine                                      | Description   |
|--|---|
| <a href="#">GUI_SetFuncGetFallbackFont()</a> | Sets a callback function which is called to retrieve a fallback font. |

### Data structures

| Structure                    | Description  |
|------------------------------|--|
| <a href="#">GUI_FONTINFO</a> | This structure is used when retrieving information about a font. |
| <a href="#">GUI_TTF_CS</a>   |  |
| <a href="#">GUI_TTF_DATA</a> | Contains the raw data of a TTF font file.                        |

### Defines

| Group of defines                | Description   |
|---------------------------------|---|
| <a href="#">Font info flags</a> | Flags that define the type of a font.                               |
| <a href="#">SIF font types</a>  | SIF font types to be used by <a href="#">GUI_SIF_CreateFont()</a> . |
| <a href="#">XBF font types</a>  | XBF font types to be used by <a href="#">GUI_XBF_CreateFont()</a> . |

## 5.6.8.1 SIF file related font functions

### 5.6.8.1.1 GUI\_SIF\_CreateFont()

#### Description

Sets the font to be used by passing a pointer to system independent font data.

#### Prototype

```
void GUI_SIF_CreateFont(const void          * pFontData,
                       GUI_FONT           * pFont,
                       const GUI_SIF_TYPE * pFontType);
```

#### Parameters

| Parameter              | Description  |
|------------------------|--|
| <code>pFontData</code> | Pointer to the system independent font data.                                 |
| <code>pFont</code>     | Pointer to a <code>GUI_FONT</code> structure in RAM filled by the function.  |
| <code>pFontType</code> | See a full list of available values under <i>SIF font types</i> on page 588. |

#### Additional information

Contrary to the emWin standard fonts which must be compiled and linked with the application program, system independent fonts (SIF) are binary data blocks containing the font information. The Font Converter can be used to create system independent fonts. This tool is not part of the basic package. A short description follows later in this chapter. For details about how to create system independent fonts, refer to the chapter *Font Converter* on page 2832.

When using this function emWin needs to fill a `GUI_FONT` structure with the font information. The user needs to pass a pointer to this structure in the parameter `pFont`. The contents of this structure must remain valid during the use of the font. The function does not know what kind of font should be created. To tell the function the type of the font to be created it must be passed in the parameter `pFontType`. This has been done to avoid linkage of code which is not required.

#### Example

```
static GUI_FONT _Font; // Font structure in RAM

GUI_SIF_CreateFont(_DownloadedFont, &_Font, GUI_SIF_TYPE_PROP);
GUI_DispString("Hello World!");
```

### 5.6.8.1.2 GUI\_SIF\_DeleteFont()

#### Description

Deletes a font pointed by the parameter `pFont`.

#### Prototype

```
void GUI_SIF_DeleteFont(GUI_FONT * pFont);
```

#### Parameters

| Parameter          | Description                        |
|--------------------|------------------------------------|
| <code>pFont</code> | Pointer to the font to be deleted. |

#### Additional information

After using a font created with `GUI_SIF_CreateFont()` the font should be deleted if not used anymore.

#### Example

```
static GUI_FONT _Font; // Font structure in RAM

GUI_SIF_CreateFont(_DownloadedFont, &_Font, GUI_SIF_TYPE_PROP);
//
// Use the font
//
GUI_SIF_DeleteFont(&_Font);
```

## 5.6.8.2 TTF file related functions

The emWin implementation of TTF file support is based on the FreeType font library from David Turner, Robert Wilhelm and Werner Lemberg. For details, refer to *TrueType Font (TTF) format* on page 531.

### 5.6.8.2.1 GUI\_TTF\_CreateFont()

#### Description

Creates and selects an emWin font by using a TTF font file.

#### Prototype

```
int GUI_TTF_CreateFont(GUI_FONT * pFont,
                      GUI_TTF_CS * pCS);
```

#### Parameters

| Parameter          | Description   |
|--------------------|---|
| <code>pFont</code> | Pointer to a GUI_FONT structure in RAM filled by the function.        |
| <code>pCS</code>   | Pointer to a GUI_TTF_CS structure containing the creation parameters. |

#### Return value

0        on success  
1        on error.

#### Additional information

When using the function the first time it initializes the TTF engine and the internal cache system. If the cache should use other values as defined per default it needs to be configured before the first call of this function. For details how to configure the cache, refer to `GUI_TTF_SetCacheSize()`.

The internal data cache manages the complete mechanism of creating fonts and caching bitmap data. Font faces are uniquely identified from the cache by the address given in parameter `pTTF` and the parameter `FaceIndex`, which normally is 0. If the same font file for example should be used for creating fonts of different sizes the parameter `pTTF` should point to the same location of a `GUI_TTF_DATA` structure. The parameter `PixelHeight` specifies the height of the surrounding rectangle between the glyphs 'g' and 'f'. The value `PixelHeight` does not represent the offset between lines.

#### Example

```
GUI_TTF_CS  Cs0, Cs1;
GUI_TTF_DATA Data;
GUI_FONT    Font0, Font1;
//
// Set parameters for accessing the font file
//
Data.pData   = aTTF;           // Address
Data.NumBytes = sizeof(aTTF); // Size
//
// Set creation parameters of first font
//
Cs0.pTTF     = &Data;         // Use address of GUI_TTF_DATA
Cs0.PixelHeight = 24;         // Pixel height
Cs0.FaceIndex = 0;           // Initialize to 0
//
// Set creation parameters of second font
//
Cs1.pTTF     = &Data;         // Use address of GUI_TTF_DATA
```

```
Cs1.PixelHeight = 48;           // Pixel height
Cs1.FaceIndex   = 0;           // Initialize to 0
//
// Create 2 fonts
//
GUI_TTF_CreateFont(&Font0, &Cs0);
GUI_TTF_CreateFont(&Font1, &Cs1);
//
// Draw something using the fonts
//
GUI_SetFont(&Font0);
GUI_DispString("Hello world\n");
GUI_SetFont(&Font1);
GUI_DispString("Hello world");
```



### 5.6.8.2.2 GUI\_TTF\_CreateFontAA()

#### Description

Creates and selects an antialiased emWin font by using a TTF font file.

#### Prototype

```
int GUI_TTF_CreateFontAA(GUI_FONT * pFont,  
                        GUI_TTF_CS * pCS);
```

#### Parameters

| Parameter | Description   |
|-----------|---|
| pFont     | Pointer to a GUI_FONT structure in RAM filled by the function.        |
| pCS       | Pointer to a GUI_TTF_CS structure containing the creation parameters. |

#### Return value

0        on success  
1        on error.

### 5.6.8.2.3 GUI\_TTF\_EmboldenFont()

| Before                                       | After   |
|--|---|
| The quick brown fox jumps over the lazy dog. | <b>The quick brown fox jumps over the lazy dog.</b> |

#### Description

Renders the given TTF font as bold. An optimal strength for embolding is calculated using this formula:

$$\text{Embolding str. in px} = (2\frac{2}{3} * \text{Font size in pt}) / 64$$

To override the embolding strength, `GUI_TTF_EmboldenFontEx()` can be used.

#### Prototype

```
int GUI_TTF_EmboldenFont(GUI_FONT * pFont,
                        U8 Embolden);
```

#### Parameters

| Parameter             | Description   |
|-----------------------|---|
| <code>pFont</code>    | Pointer to a <code>GUI_FONT</code> structure which has been created using <code>GUI_TTF_CreateFont()</code> . |
| <code>Embolden</code> | 1 for embolding the font, 0 for disabling.  |

#### Return value

0 On success.  
1 On error.

#### Additional information

Please note the following:

1. The TrueType engine transforms the glyphs of the font and therefore does not use a cache for rendering emboldened letters. This has an impact on performance compared to rendering TTF fonts with a cache.
2. It is recommended to call `GUI_SetTextMode(GUI_TM_TRANS);` before displaying an emboldened font because if the strength is too thick, characters could overlap.
3. This routine can also be called in conjunction with `GUI_TTF_ObliqueFont()` to create a bold oblique font.

### 5.6.8.2.4 GUI\_TTF\_EmboldenFontEx()

| Before                                       | After   |
|--|---|
| The quick brown fox jumps over the lazy dog. | <b>The quick brown fox jumps over the lazy dog.</b> |

#### Description

Renders the given TTF font as bold. A custom strength can be used for this which is expressed in the 26.6 fractional pixel format (1 unit = 1/64 pixel).

#### Prototype

```
int GUI_TTF_EmboldenFontEx(GUI_FONT * pFont,
                          I32      Strength);
```

#### Parameters

| Parameter             | Description   |
|-----------------------|---|
| <code>pFont</code>    | Pointer to a GUI_FONT structure which has been created using GUI_TTF_CreateFont().  |
| <code>Strength</code> | <code>Strength</code> for embolding used for X and Y in 26.6 fractional pixels (1 unit = 1/64 pixel), e.g.: 56 equals 0.875 pixels of added thickness.<br>0 disables embolding. |

#### Return value

0        On success.  
1        On error.

#### Additional information

Negative strength values are also legal to make the font thinner.

Refer to GUI\_TTF\_EmboldenFont() for general notes on embolding TTF fonts.

For more information about the 26.6 fractional pixel format, please refer to the FreeType documentation.

### 5.6.8.2.5 GUI\_TTF\_GetFamilyName()

#### Description

The function returns the font family name defined in the font file.

#### Prototype

```
int GUI_TTF_GetFamilyName(GUI_FONT * pFont,  
                          char      * pBuffer,  
                          int       NumBytes);
```

#### Parameters

| Parameter             | Description  |
|-----------------------|--|
| <code>pFont</code>    | Pointer to a GUI_FONT structure which has been created using GUI_TTF_CreateFont(). |
| <code>pBuffer</code>  | Buffer to be filled with the family name.  |
| <code>NumBytes</code> | Size of buffer in bytes.   |

#### Return value

0        on success  
1        on error.

### 5.6.8.2.6 GUI\_TTF\_GetStyleName()

#### Description

The function returns the style name (bold, regular, ...) defined in the font file.

#### Prototype

```
int GUI_TTF_GetStyleName(GUI_FONT * pFont,  
                        char * pBuffer,  
                        int NumBytes);
```

#### Parameters

| Parameter             | Description  |
|-----------------------|--|
| <code>pFont</code>    | Pointer to a GUI_FONT structure which has been created using GUI_TTF_CreateFont(). |
| <code>pBuffer</code>  | Buffer to be filled with the style name.   |
| <code>NumBytes</code> | Size of buffer in bytes.   |

#### Return value

0 on success  
1 on error.

### 5.6.8.2.7 GUI\_TTF\_ObliqueFont()

| Before                                       | After   |
|--|---|
| The quick brown fox jumps over the lazy dog. | <i>The quick brown fox jumps over the lazy dog.</i> |

#### Description

Renders the given TTF font as oblique. The letters of the font are slanted by an angle of 9.568° to the right.

#### Prototype

```
int GUI_TTF_ObliqueFont(GUI_FONT * pFont,
                       U8         Oblique);
```

#### Parameters

| Parameter            | Description  |
|----------------------|--|
| <code>pFont</code>   | Pointer to a GUI_FONT structure which has been created using GUI_TTF_CreateFont(). |
| <code>Oblique</code> | 1 for obliquing the font, 0 for disabling.   |

#### Return value

0        On success.  
1        On error.

#### Additional information

Please note the following:

1. The TrueType engine transforms the glyphs of the font and therefore does not use a cache for rendering slanted letters. This has an impact on performance compared to rendering TTF fonts with a cache.
2. It is recommended to call GUI\_SetTextMode(GUI\_TM\_TRANS); before displaying an obliqued font because if the angle is too high, characters could overlap.
3. This routine can also be called in conjunction with GUI\_TTF\_EmboldenFont() to create a bold oblique font.

### 5.6.8.2.8 GUI\_TTF\_ObliqueFontEx()

| Before                                       | After   |
|--|---|
| The quick brown fox jumps over the lazy dog. | <i>The quick brown fox jumps over the lazy dog.</i> |

#### Description

Renders the given TTF font as oblique. The letters of the font are slanted to the right by a given angle.

#### Prototype

```
int GUI_TTF_ObliqueFontEx(GUI_FONT * pFont,
                          I32      Angle);
```

#### Parameters

| Parameter          | Description  |
|--------------------|--|
| <code>pFont</code> | Pointer to a GUI_FONT structure which has been created using GUI_TTF_CreateFont().   |
| <code>Angle</code> | <code>Angle * 1000</code> ( $10^\circ = 10000$ ). <code>Angle</code> must be between 1 and 45000 ( $0.001^\circ$ to $45^\circ$ ). If a 0 is passed, obliqueing is disabled for the font. |

#### Return value

0        On success.  
1        On error.

#### Additional information

Note that the character width remains unchanged in order for the font to appear oblique. An angle too large means the font would be too wide to be displayed entirely.

Refer to GUI\_TTF\_ObliqueFont() for additional notes.

### 5.6.8.3 XBF file related font functions

#### 5.6.8.3.1 GUI\_XBF\_CreateFont()

##### Description

Creates and selects a font by passing a pointer to a callback function, which is responsible for getting data from the XBF font file.

##### Prototype

```
int GUI_XBF_CreateFont(      GUI_FONT          * pFont,
                             GUI_XBF_DATA        * pXBF_Data,
                             const GUI_XBF_TYPE   * pFontType,
                             GUI_XBF_GET_DATA_FUNC * pfGetData,
                             void                 * pVoid);
```

##### Parameters

| Parameter              | Description   |
|------------------------|---|
| <code>pFont</code>     | Pointer to a <code>GUI_FONT</code> structure in RAM filled by the function.                                   |
| <code>pXBF_Data</code> | Pointer to a <code>GUI_XBF_DATA</code> structure in RAM filled by the function.                               |
| <code>pFontType</code> | See a full list of available values under <i>XBF font types</i> on page 589.                                  |
| <code>pfGetData</code> | Pointer to a callback function which is responsible for getting data from the font file. See prototype below. |
| <code>pVoid</code>     | Application defined pointer passed to the 'GetData' callback function.  |

##### Prototype of GUI\_XBF\_GET\_DATA\_FUNC

```
int GUI_XBF_GET_DATA_FUNC(U32   Off,
                          U16   NumBytes,
                          void * pVoid,
                          void * pBuffer);
```

The function has to set `pBuffer` to point to the location the requested data resides in.

##### Return value

0        on success  
1        if font creation fails.

##### Additional information

The parameter `pfGetData` should point to an application defined callback routine, which is responsible for getting data from the font. Parameter `pVoid` is passed to the callback function when requesting font data. It can be used for example to pass a file handle to the callback function.

The function requires pointers to a `GUI_FONT` structure and a `GUI_XBF_DATA` structure. The function will fill these structures with font information. It is required, that the contents of these structures remain valid during the usage of the font. The function does not know what kind of XBF font has to be created, so the parameter `pFont-Type` has to be used to tell the function the type of the font to be created. This has been done to avoid unnecessary linkage of code.

The maximum number of data bytes per character is limited to 200 per default. If the number of characters exceed this limit banding is used to display the remaining characters. This should cover the most requirements. If loading a character with more bytes a warning will be generated in the debug version. The default value can be increased by adding the following define to the file `GUIConf.h`:



```
#define GUI_MAX_XBF_BYTES 500 // Sets the maximum number of bytes/chars to 500
```

## Example

```
static GUI_FONT      Font;      // GUI_FONT structure in RAM
static GUI_XBF_DATA XBF_Data;  // GUI_XBF_DATA structure in RAM
static int _cbGetData(U32 Off, U16 NumBytes, void * pVoid, void * pBuffer) {
    //
    // The pVoid pointer may be used to get a file handle
    //
    ...// TBD
    //
    // Set file pointer to the given position
    //
    ...// TBD
    //
    // Read the required number of bytes into the given buffer
    //
    ...// TBD
    //
    // Return 0 on success. Return 1 if the function fails.
    //
}
GUI_XBF_CreateFont(&Font, &XBF_Data, GUI_XBF_TYPE_PROP, _cbGetData, pVoid);
```

### 5.6.8.3.2 GUI\_XBF\_DeleteFont()

#### Description

Deletes an XBF font pointed by the parameter `pFont`.

#### Prototype

```
void GUI_XBF_DeleteFont(GUI_FONT * pFont);
```

#### Parameters

| Parameter          | Description                        |
|--------------------|------------------------------------|
| <code>pFont</code> | Pointer to the font to be deleted. |

#### Additional information

After using a font created with `GUI_XBF_CreateFont()` the font should be deleted if not used anymore.

## 5.6.8.4 BDF file related font functions

### 5.6.8.4.1 GUI\_BDF\_CreateFont()

#### Description

Creates and selects an emWin font by using a BDF font file.

#### Prototype

```
int GUI_BDF_CreateFont(      GUI_FONT * pFont,
                           const U8      * pData,
                           U32           Size);
```

#### Parameters

| Parameter          | Description  |
|--------------------|--|
| <code>pFont</code> | Pointer to a GUI_FONT structure in RAM filled by the function. |
| <code>pData</code> | Pointer to data buffer that contains the BDF font file.        |
| <code>Size</code>  | <code>Size</code> of the data buffer.                          |

#### Return value

0        Success.  
1        Error.

#### Additional information

When using the function the first time it initializes the TTF engine. The routine `GUI_BDF_DeleteFont()` deletes a font. By calling `GUI_BDF_Done()` all memory allocated by the TTF engine will be deleted.

### 5.6.8.4.2 GUI\_BDF\_DeleteFont()

#### Description

Frees all allocated memory for an emWin font created from a BDF font file.

#### Prototype

```
int GUI_BDF_DeleteFont(GUI_FONT * pFont);
```

#### Parameters

| Parameter          | Description      |
|--------------------|------------------|
| <code>pFont</code> | Pointer to font. |

#### Return value

- 0 Font was successfully deleted.
- 1 Error when deleting the font.

#### Additional information

To free all memory allocated by the TTF engine, call `GUI_FT_Done()`.

### 5.6.8.4.3 GUI\_BDF\_EmboldenFont()

#### Description

Renders the given BDF font as bold.

#### Prototype

```
int GUI_BDF_EmboldenFont(GUI_FONT * pFont,  
                        U8 Embolden);
```

#### Parameters

| Parameter             | Description  |
|-----------------------|--|
| <code>pFont</code>    | Pointer to a GUI_FONT structure which has been created using GUI_BDF_CreateFont(). |
| <code>Embolden</code> | 1 for embolding the font, 0 for disabling.   |

#### Return value

0 On success.  
1 On error.

#### 5.6.8.4.4 GUI\_BDF\_EmboldenFontEx()

##### Description

Renders the given BDF font as bold. A custom strength can be used for this which is expressed in the 26.6 fractional pixel format (1 unit = 1/64 pixel).

##### Prototype

```
int GUI_BDF_EmboldenFontEx(GUI_FONT * pFont,
                          I32      Strength);
```

##### Parameters

| Parameter             | Description   |
|-----------------------|---|
| <code>pFont</code>    | Pointer to a GUI_FONT structure which has been created using GUI_BDF_CreateFont().                    |
| <code>Strength</code> | <code>Strength</code> for embolding used for X and Y in 26.6 fractional pixels. 0 disables embolding. |

##### Return value

0        On success.  
1        On error.

##### Additional information

For more information about the 26.6 fractional pixel format, please refer to the FreeType documentation.

### 5.6.8.4.5 GUI\_BDF\_GetFamilyName()

#### Description

The function returns the font family name defined in the font file.

#### Prototype

```
int GUI_BDF_GetFamilyName(GUI_FONT * pFont,  
                           char      * pBuffer,  
                           int       NumBytes);
```

#### Parameters

| Parameter             | Description   |
|-----------------------|---|
| <code>pFont</code>    | Pointer to a <code>GUI_FONT</code> structure which has been created using <code>GUI_BDF_CreateFont()</code> . |
| <code>pBuffer</code>  | Buffer to be filled with the family name.   |
| <code>NumBytes</code> | Size of buffer in bytes.  |

#### Return value

0        on success  
1        on error.

#### 5.6.8.4.6 GUI\_BDF\_GetStyleName()

##### Description

The function returns the style name (bold, regular, ...) defined in the font file.

##### Prototype

```
int GUI_BDF_GetStyleName(GUI_FONT * pFont,  
                        char * pBuffer,  
                        int NumBytes);
```

##### Parameters

| Parameter             | Description  |
|-----------------------|--|
| <code>pFont</code>    | Pointer to a GUI_FONT structure which has been created using GUI_BDF_CreateFont(). |
| <code>pBuffer</code>  | Buffer to be filled with the style name.   |
| <code>NumBytes</code> | Size of buffer in bytes.   |

##### Return value

0 on success  
1 on error.



### 5.6.8.4.7 GUI\_BDF\_SetLetterSpacing()

#### Description

Sets a spacing that is added/subtracted to each letter of the font. The value is added to the characters cursor distance. The new cursor distance cannot be negative.

#### Prototype

```
int GUI_BDF_SetLetterSpacing(GUI_FONT * pFont,  
                             int      Spacing);
```

#### Parameters

| Parameter            | Description  |
|----------------------|--|
| <code>pFont</code>   | Pointer to a GUI_FONT structure which has been created using GUI_BDF_CreateFont(). |
| <code>Spacing</code> | Absolute spacing in pixels to be added to each character (can also be negative).   |

#### Return value

Old spacing value.

## 5.6.8.5 FreeType related font functions

### 5.6.8.5.1 GUI\_FT\_DestroyCache()

#### Description

This function frees all memory allocated by the FreeType cache system and destroys the cache.

#### Prototype

```
void GUI_FT_DestroyCache(void);
```

#### Additional information

The next time `GUI_TTF_CreateFont()` or `GUI_BDF_CreateFont()` is used, emWin automatically creates and initializes a new cache.

### 5.6.8.5.2 GUI\_FT\_Done()

#### Description

This function frees all memory allocated by the FreeType engine and its internal cache system.

#### Prototype

```
void GUI_FT_Done(void);
```

#### Additional information

The next time `GUI_TTF_CreateFont()` or `GUI_BDF_CreateFont()` is used, emWin automatically initializes the TTF engine and creates and initializes a new cache.

### 5.6.8.5.3 GUI\_FT\_GetMeasurementChars()

#### Description

Returns the characters that are used for measuring the font metrics of newly created TTF and BDF fonts.

#### Prototype

```
void GUI_FT_GetMeasurementChars(U16 * pLowerHeight,  
                                U16 * pUpperHeight);
```

#### Parameters

| Parameter                 | Description  |
|---------------------------|--|
| <code>pLowerHeight</code> | Pointer to an U16 to store the character used to measure the height of a lower case letter.  |
| <code>pUpperHeight</code> | Pointer to an U16 to store the character used to measure the height of an upper case letter. |

#### 5.6.8.5.4 GUI\_FT\_SetCacheSize()

##### Description

Sets the size parameters used to create the cache on the first call of `GUI_TTF_CreateFont()` or `GUI_BDF_CreateFont()`.

##### Prototype

```
void GUI_FT_SetCacheSize(unsigned MaxFaces,
                        unsigned MaxSizes,
                        U32      MaxBytes);
```

##### Parameters

| Parameter             | Description  |
|-----------------------|--|
| <code>MaxFaces</code> | Maximum number of font faces the cache should be able to handle simultaneously. 0 selects default value.   |
| <code>MaxSizes</code> | Maximum number of size objects the cache should be able to handle simultaneously. 0 selects default value. |
| <code>MaxBytes</code> | Maximum number of bytes used for the bitmap cache. 0 selects default value.                                |

##### Return value

0        on success  
1        on error.

##### Additional information

If for example 3 font faces should be used, each with 2 sizes, the cache should be able to manage 6 size objects. The default values used by the TTF engine are: 2 faces, 4 size objects and 200K of bitmap data cache.

### 5.6.8.5.5 GUI\_FT\_SetMeasurementChars()

#### Description

Sets the characters that are used for measuring the font metrics of newly created TTF and BDF fonts.

The default characters are:

- Character for lower case height: **g**
- Character for upper case height: **M**

It makes sense to change the measurement characters if the BDF or TTF fonts that are used do not contain the default characters.

#### Prototype

```
void GUI_FT_SetMeasurementChars(U16 LowerHeight,  
                               U16 UpperHeight);
```

#### Parameters

| Parameter                   | Description   |
|-----------------------------|---|
| <a href="#">LowerHeight</a> | Character for measuring the height of lower case letters  |
| <a href="#">UpperHeight</a> | Character for measuring the height of upper case letters. |

#### Additional information

The set characters are used for all TTF and BDF fonts that are created afterwards.

## 5.6.8.6 Common font-related functions

### 5.6.8.6.1 GUI\_GetCharDistX()

#### Description

Returns the width in pixels (X-size) used to display a specified character in the currently selected font.

#### Prototype

```
int GUI_GetCharDistX(U16 c);
```

#### Parameters

| Parameter | Description                        |
|-----------|------------------------------------|
| c         | Character to calculate width from. |

### 5.6.8.6.2 GUI\_GetDefaultFont()

#### Description

Returns the default currently set default font.

#### Prototype

```
GUI_FONT *GUI_GetDefaultFont(void);
```

#### Return value

This function returns a pointer to the currently set default font.



### 5.6.8.6.3 GUI\_GetFallbackFont()

#### Description

Returns a font which contains the given character.

#### Prototype

```
GUI_FONT *GUI_GetFallbackFont(U16 c);
```

#### Parameters

| Parameter | Description                                  |
|-----------|--|
| c         | Character which needs to be within the font. |

#### Return value

Returns a pointer to a fallback font.

#### Additional information

This function requires a fallback font set or callback function to retrieve a fallback font. Please refer to `GUI_SetFuncGetFallbackFont()` and `GUI_SetFallbackFont()`.

#### 5.6.8.6.4 GUI\_GetFont()

##### Description

Returns a pointer to the currently selected font.

##### Prototype

```
GUI_FONT *GUI_GetFont(void);
```

##### Return value

This function returns a pointer to the currently selected font.

### 5.6.8.6.5 GUI\_GetFontDistY()

#### Description

Returns the Y-spacing of the currently selected font.

#### Prototype

```
int GUI_GetFontDistY(void);
```

#### Return value

This function returns the Y-spacing of the currently selected font.

#### Additional information

The Y-spacing is the vertical distance in pixels between two adjacent lines of text. The returned value is the YDist value of the entry for the currently selected font. The returned value is valid for both proportional and monospaced fonts.

### 5.6.8.6.6 GUI\_GetFontInfo()

#### Description

Calculates a pointer to a GUI\_FONTINFO structure of a particular font.

#### Prototype

```
void GUI_GetFontInfo(const GUI_FONT      * pFont,  
                    GUI_FONTINFO * pFontInfo);
```

#### Parameters

| Parameter              | Description                          |
|------------------------|--------------------------------------|
| <code>pFont</code>     | Pointer to the font.                 |
| <code>pFontInfo</code> | Pointer to a GUI_FONTINFO structure. |

#### Example

Gets the info of GUI\_Font6x8. After the calculation `FontInfo.Flags` contains the flag `GUI_FONTINFO_FLAG_MONO`.

```
GUI_FONTINFO FontInfo;  
GUI_GetFontInfo(&GUI_Font6x8, &FontInfo);
```

### 5.6.8.6.7 GUI\_GetFontSizeY()

#### Description

Returns the height in pixels (Y-size) of the currently selected font.

#### Prototype

```
int GUI_GetFontSizeY(void);
```

#### Return value

Size of the currently selected font in pixels.

#### Additional information

The returned value is the YSize value of the entry for the currently selected font. This value is less than or equal to the Y-spacing returned by the function `GUI_GetFontDistY()`. The returned value is valid for both proportional and monospaced fonts.

### 5.6.8.6.8 GUI\_GetLeadingBlankCols()

#### Description

Returns the number of leading blank pixel columns in the currently selected font for the given character.

#### Prototype

```
int GUI_GetLeadingBlankCols(U16 c);
```

#### Parameters

| Parameter | Description           |
|-----------|-----------------------|
| c         | Character to be used. |

#### Return value

- ≠ -1 Number of leading blank pixel columns in the currently selected font for the given character.
- = -1 On error.

#### Example

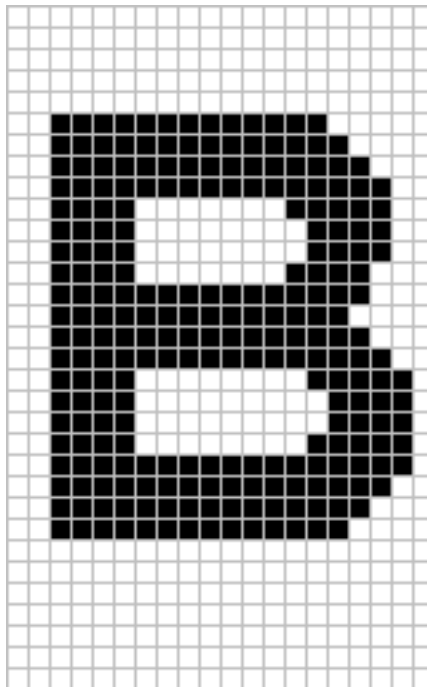

The result for the character 'B' shown in the screenshot above would be 2.

### 5.6.8.6.9 GUI\_GetLeadingBlankRows()

#### Description

Returns the number of leading blank pixel rows in the currently selected font for the given character.

#### Prototype

```
int GUI_GetLeadingBlankRows(U16 c);
```

#### Parameters

| Parameter | Description           |
|-----------|-----------------------|
| c         | Character to be used. |

#### Return value

- ≠ -1 Number of leading blank pixel columns in the currently selected font for the given character.
- = -1 On error.

#### Example

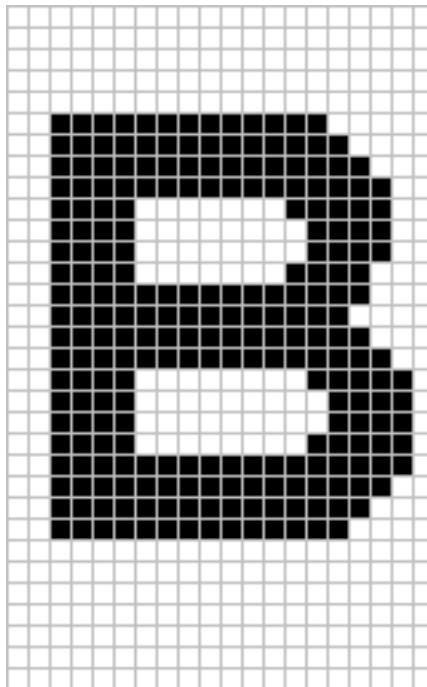

The result for the character 'B' shown in the screenshot above would be 5.

### 5.6.8.6.10 GUI\_GetStringDistX()

#### Description

Returns the X-size used to display a specified string in the currently selected font.

#### Prototype

```
int GUI_GetStringDistX(const char * s);
```

#### Parameters

| Parameter | Description            |
|-----------|------------------------|
| s         | Pointer to the string. |

#### Return value

≠ -1 X-size used to display a specified string in the currently selected font.  
= -1 Error.



### 5.6.8.6.11 GUI\_GetStringDistXEx()

#### Description

Returns the X-size used to display a number of characters of a string in the currently selected font.

#### Prototype

```
int GUI_GetStringDistXEx(const char * s,  
                        int n);
```

#### Parameters

| Parameter      | Description                                      |
|----------------|--|
| <code>s</code> | Pointer to the string.                           |
| <code>n</code> | Number of characters counted from the beginning. |

#### Return value

≠ -1 X-size used to display a specified string in the currently selected font.  
= -1 Error.

### 5.6.8.6.12 GUI\_GetTextExtend()

#### Description

Calculates the text rectangle for drawing the given string. The rectangle is calculated based on the currently set font and position.

#### Prototype

```
void GUI_GetTextExtend(    GUI_RECT * pRect ,
                          const char * s ,
                          int      MaxNumChars );
```

#### Parameters

| Parameter             | Description                                    |
|-----------------------|--|
| <a href="#">pRect</a> | Pointer to GUI_RECT-structure to store result. |
| <a href="#">s</a>     | Pointer to the string.                         |
| <a href="#">Len</a>   | Number of characters of the string.            |

### 5.6.8.6.13 GUI\_GetTrailingBlankCols()

#### Description

Returns the number of trailing blank pixel columns in the currently selected font for the given character.

#### Prototype

```
int GUI_GetTrailingBlankCols(U16 c);
```

#### Parameters

| Parameter | Description           |
|-----------|-----------------------|
| c         | Character to be used. |

#### Return value

- ≠ -1 Number of trailing blank pixel columns in the currently selected font for the given character.
- = -1 On error.

#### Example

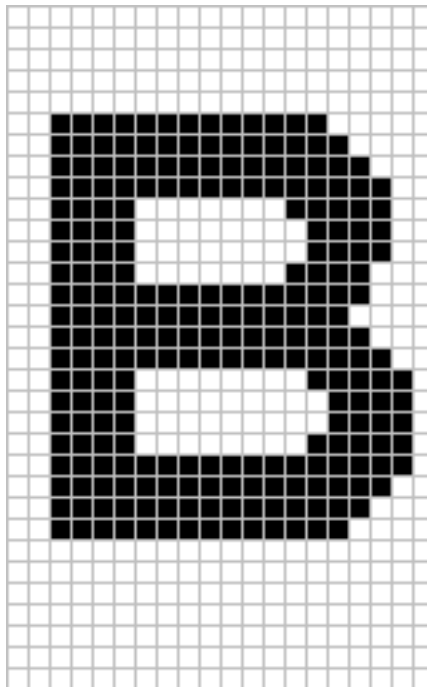

The result for the character 'B' shown in the screenshot above would be 1.

### 5.6.8.6.14 GUI\_GetTrailingBlankRows()

#### Description

Returns the number of leading blank pixel rows in the currently selected font for the given character.

#### Prototype

```
int GUI_GetTrailingBlankRows(U16 c);
```

#### Parameters

| Parameter | Description           |
|-----------|-----------------------|
| c         | Character to be used. |

#### Return value

- ≠ -1 Number of leading blank pixel columns in the currently selected font for the given character.
- = -1 On error.

#### Example

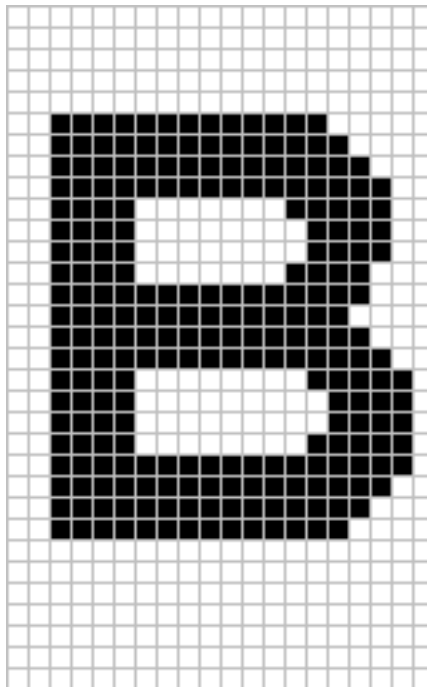

The result for the character 'B' shown in the screenshot above would be 7.

### 5.6.8.6.15 GUI\_GetYDistOfFont()

#### Description

Returns the Y-spacing of a particular font.

#### Prototype

```
int GUI_GetYDistOfFont(const GUI_FONT * pFont);
```

#### Parameters

| Parameter          | Description          |
|--------------------|----------------------|
| <code>pFont</code> | Pointer to the font. |

#### Return value

Y-spacing of the font.

#### Additional information

Please refer to `GUI_GetFontDistY()`.

### 5.6.8.6.16 GUI\_GetYSizeOfFont()

#### Description

Returns the Y-size of a particular font.

#### Prototype

```
int GUI_GetYSizeOfFont(const GUI_FONT * pFont);
```

#### Parameters

| Parameter          | Description          |
|--------------------|----------------------|
| <code>pFont</code> | Pointer to the font. |

#### Return value

Y-size of the font.

#### Additional information

Additional information can be found in the description of `GUI_GetFontSizeY()`.

### 5.6.8.6.17 GUI\_IsInFont()

#### Description

Evaluates whether a particular font contains a specified character or not.

#### Prototype

```
char GUI_IsInFont(const GUI_FONT * pFont,  
                 U16          c);
```

#### Parameters

| Parameter          | Description                   |
|--------------------|-------------------------------|
| <code>pFont</code> | Pointer to the font.          |
| <code>c</code>     | Character to be searched for. |

#### Return value

- 1 if the character was found.
- 0 if the character was not found.

#### Additional information

If the pointer `pFont` is set to 0, the currently selected font is used.

#### Example

Evaluates whether the font `GUI_FontD32` contains an "X":

```
if (GUI_IsInFont(&GUI_FontD32, 'X') == 0) {  
    GUI_DispString("GUI_FontD32 does not contain 'X'");  
}
```

### 5.6.8.6.18 GUI\_SetDefaultFont()

#### Description

Sets the font to be used by default for text output.

#### Prototype

```
void GUI_SetDefaultFont(const GUI_FONT * pFont);
```

#### Parameters

| Parameter          | Description                                   |
|--------------------|---|
| <code>pFont</code> | Pointer to the font to be selected as default |

#### Additional information

This function is intended to be used in `GUI_X_Config()`. Defining `GUI_DEFAULT_FONT` is not mandatory anymore. If there is neither defined `GUI_DEFAULT_FONT` nor `GUI_SetDefaultFont` is called, `GUI_Font6x8` will be set as the default Font. If none of the emWin fonts shall be used, `GUI_DEFAULT_FONT` has to be defined by `NULL` and a custom font needs to be set as default with this function.



### 5.6.8.6.19 GUI\_SetFallbackFont()

#### Description

Sets a fallback font which is used if the default font does not contain the required characters.

#### Prototype

```
GUI_FONT *GUI_SetFallbackFont(const GUI_FONT * pNewFont);
```

#### Parameters

| Parameter          | Description                     |
|--------------------|---------------------------------|
| <code>pFont</code> | Pointer to the font to be used. |

#### Return value

Returns a pointer to the previously set font.

### 5.6.8.6.20 GUI\_SetFont()

#### Description

Sets the font to be used for text output.

#### Prototype

```
GUI_FONT *GUI_SetFont(const GUI_FONT * pNewFont);
```

#### Parameters

| Parameter | Description                                  |
|-----------|--|
| pFont     | Pointer to the font to be selected and used. |

#### Return value

Returns a pointer to the previously selected font so that it may be buffered.

#### Example

Displays example text in 3 different sizes, restoring the former font afterwards:

```
const GUI_FONT GUI_FLASH * OldFont;
OldFont = GUI_SetFont(&GUI_Font8x16);           // Buffer old font
GUI_DispStringAt("This text is 8 by 16 pixels", 0, 0);
GUI_SetFont(&GUI_Font6x8);
GUI_DispStringAt("This text is 6 by 8 pixels", 0, 20);
GUI_SetFont(&GUI_Font8);
GUI_DispStringAt("This text is proportional", 0, 40);
GUI_SetFont(OldFont);                           // Restore old font
```

#### Screenshot of above example

```

This text is 8 by 16 pixels
This text is 6 by 8 pixels
This text is proportional

```

#### Example

Displays text and value in different fonts:

```
GUI_SetFont(&GUI_Font6x8);
GUI_DispString("The result is: "); // Disp text
GUI_SetFont(&GUI_Font8x8);
GUI_DispDec(42, 2);                // Disp value
```

#### Screenshot of above example

```
The result is: 42
```

### 5.6.8.6.21 GUI\_SetFuncGetFallbackFont()

#### Description

Sets a callback function which is called to retrieve a fallback font.

#### Prototype

```
void GUI_SetFuncGetFallbackFont(const GUI_FONT * ( *pfcgGetFallbackFont)(U16 c ));
```

#### Parameters

| Parameter                        | Description                      |
|----------------------------------|----------------------------------|
| <code>pfcgGetFallbackFont</code> | Pointer to the callback function |

## 5.6.8.7 Data structures

### 5.6.8.7.1 GUI\_FONTINFO

#### Description

This structure is used when retrieving information about a font.

#### Type definition

```
typedef struct {
    U16  Flags;
    U8   Baseline;
    U8   LHeight;
    U8   CHeight;
} GUI_FONTINFO;
```

#### Structure members

| Member                   | Description  |
|--------------------------|--|
| <a href="#">Flags</a>    | <a href="#">Flags</a> that define the type of the font. Permitted values are explained in <i>Font info flags</i> on page 587.                      |
| <a href="#">Baseline</a> | Height of the baseline. The baseline is the line where most, but not all characters are 'placed on'. The lowest part of an 'A' is on the baseline. |
| <a href="#">LHeight</a>  | Height of a lower case character such as 'a' or 'x'.   |
| <a href="#">CHeight</a>  | Height of an upper case character such as 'A' or 'X'.  |

#### See also

- `GUI_GetFontInfo()`

### 5.6.8.7.2 GUI\_TTF\_CS

#### Type definition

```
typedef struct {
    GUI_TTF_DATA * pTTF;
    U32             aImageTypeBuffer[];
    int            PixelHeight;
    int            FaceIndex;
    I32            BoldStrength;
    I32            aObliqueMatrix[];
    U8             EmFlags;
} GUI_TTF_CS;
```

#### Structure members

| Member                        | Description   |
|-------------------------------|---|
| <code>pTTF</code>             | Pointer to GUI_TTF_DATA structure which contains location and size of font file.  |
| <code>aImageTypeBuffer</code> | Internal use.   |
| <code>PixelHeight</code>      | Pixel height of new font. It means the height of the surrounding rectangle between the glyphs 'g' and 'f'. Please notice that it is not the distance between two lines of text. With other words the value returned by GUI_GetFontSizeY() is not identically with this value. |
| <code>FaceIndex</code>        | Some font files can contain more than one font face. In case of more than one face this index specifies the zero based face index to be used to create the font. Usually 0.   |
| <code>BoldStrength</code>     | Internal use.   |
| <code>aObliqueMatrix</code>   | Internal use.   |
| <code>EmFlags</code>          | Internal use.   |

#### See also

- GUI\_TTF\_CreateFont()
- GUI\_TTF\_CreateFontAA()

### 5.6.8.7.3 GUI\_TTF\_DATA

#### Description

Contains the raw data of a TTF font file.

#### Type definition

```
typedef struct {  
    const void * pData;  
    U32          NumBytes;  
} GUI_TTF_DATA;
```

#### Structure members

| Member                   | Description  |
|--------------------------|--|
| <a href="#">pData</a>    | Pointer to TTF font file in addressable memory area. |
| <a href="#">NumBytes</a> | Size of file in bytes.                               |

#### See also

- [GUI\\_TTF\\_CreateFont\(\)](#)

## 5.6.8.8 Defines

### 5.6.8.8.1 Font info flags

#### Description

These flags define of what type a font is. See the chapter *Font types* on page 526 for a detailed explanation of the font types.

#### Definition

```
#define GUI_FONTINFO_FLAG_PROP      (1 << 0)
#define GUI_FONTINFO_FLAG_MONO     (1 << 1)
#define GUI_FONTINFO_FLAG_AA       (1 << 2)
#define GUI_FONTINFO_FLAG_AA2      (1 << 3)
#define GUI_FONTINFO_FLAG_AA4      (1 << 4)
#define GUI_FONTINFO_FLAG_PROPFPM  (1 << 5)
```

#### Symbols

| Definition                                | Description  |
|---|--|
| <a href="#">GUI_FONTINFO_FLAG_PROP</a>    | Font is proportional.                                |
| <a href="#">GUI_FONTINFO_FLAG_MONO</a>    | Font is monospaced.                                  |
| <a href="#">GUI_FONTINFO_FLAG_AA</a>      | Font is an antialiased font.                         |
| <a href="#">GUI_FONTINFO_FLAG_AA2</a>     | Font is an antialiased font with 2bpp anti-aliasing. |
| <a href="#">GUI_FONTINFO_FLAG_AA4</a>     | Font is an antialiased font with 4bpp anti-aliasing. |
| <a href="#">GUI_FONTINFO_FLAG_PROPFPM</a> | Font is proportional and framed.                     |

### 5.6.8.8.2 SIF font types

#### Description

Available font type defines to be used by the `pFontType` parameter in function `GUI_SIF_CreateFont()`.

#### Definition

```
#define GUI_SIF_TYPE_PROP           &GUI_SIF_APIList_Prop
#define GUI_SIF_TYPE_PROP_EXT      &GUI_SIF_APIList_Prop_Ext
#define GUI_SIF_TYPE_PROP_FRM     &GUI_SIF_APIList_Prop_Frm
#define GUI_SIF_TYPE_PROP_AA2     &GUI_SIF_APIList_Prop_AA2
#define GUI_SIF_TYPE_PROP_AA4     &GUI_SIF_APIList_Prop_AA4
#define GUI_SIF_TYPE_PROP_AA2_EXT &GUI_SIF_APIList_Prop_AA2_EXT
#define GUI_SIF_TYPE_PROP_AA4_EXT &GUI_SIF_APIList_Prop_AA4_EXT
```

#### Symbols

| Definition                             | Description  |
|--|--|
| <code>GUI_SIF_TYPE_PROP</code>         | Should be used if the parameter <code>pFont</code> points to a proportional font.  |
| <code>GUI_SIF_TYPE_PROP_EXT</code>     | Should be used if the parameter <code>pFont</code> points to an extended proportional font.                                |
| <code>GUI_SIF_TYPE_PROP_FRM</code>     | Should be used if the parameter <code>pFont</code> points to an extended proportional framed font.                         |
| <code>GUI_SIF_TYPE_PROP_AA2</code>     | Should be used if the parameter <code>pFont</code> points to a proportional font, which uses 2bpp anti-aliasing.           |
| <code>GUI_SIF_TYPE_PROP_AA4</code>     | Should be used if the parameter <code>pFont</code> points to a proportional font, which uses 4bpp anti-aliasing.           |
| <code>GUI_SIF_TYPE_PROP_AA2_EXT</code> | Should be used if the parameter <code>pFont</code> points to an extended proportional font, which uses 2bpp anti-aliasing. |
| <code>GUI_SIF_TYPE_PROP_AA4_EXT</code> | Should be used if the parameter <code>pFont</code> points to an extended proportional font, which uses 4bpp anti-aliasing. |



### 5.6.8.8.3 XBF font types

#### Description

Available font type defines to be used by the `pFontType` parameter in function `GUI_XBF_CreateFont()`.

#### Definition

```
#define GUI_XBF_TYPE_PROP           &GUI_XBF_APIList_Prop
#define GUI_XBF_TYPE_PROP_EXT      &GUI_XBF_APIList_Prop_Ext
#define GUI_XBF_TYPE_PROP_FRM      &GUI_XBF_APIList_Prop_Frm
#define GUI_XBF_TYPE_PROP_AA2_EXT  &GUI_XBF_APIList_Prop_AA2_Ext
#define GUI_XBF_TYPE_PROP_AA4_EXT  &GUI_XBF_APIList_Prop_AA4_Ext
```

#### Symbols

| Definition                             | Description  |
|--|--|
| <code>GUI_XBF_TYPE_PROP</code>         | Should be used if the parameter <code>pFont</code> points to a proportional font.  |
| <code>GUI_XBF_TYPE_PROP_EXT</code>     | Should be used if the parameter <code>pFont</code> points to an extended proportional font.                                |
| <code>GUI_XBF_TYPE_PROP_FRM</code>     | Should be used if the parameter <code>pFont</code> points to an extended framed proportional font.                         |
| <code>GUI_XBF_TYPE_PROP_AA2_EXT</code> | Should be used if the parameter <code>pFont</code> points to an extended proportional font, which uses 2bpp anti-aliasing. |
| <code>GUI_XBF_TYPE_PROP_AA4_EXT</code> | Should be used if the parameter <code>pFont</code> points to an extended proportional font, which uses 4bpp anti-aliasing. |

## 5.6.9 Character sets

### 5.6.9.1 ASCII

emWin supports the full set of ASCII characters. These are the following 96 characters from 32 to 127:

| Hex | 0 | 1 | 2 | 3 | 4  | 5 | 6 | 7 | 8 | 9 | A | B | C | D | E | F |
|-----|---|---|---|---|----|---|---|---|---|---|---|---|---|---|---|---|
| 2x  |   | ! | " | # | \$ | % | & | ' | ( | ) | * | + | , | - | . | / |
| 3x  | 0 | 1 | 2 | 3 | 4  | 5 | 6 | 7 | 8 | 9 | : | ; | < | = | > | ? |
| 4x  | @ | A | B | C | D  | E | F | G | H | I | J | K | L | M | N | O |
| 5x  | P | Q | R | S | T  | U | V | W | X | Y | Z | [ | \ | ] | ^ | _ |
| 6x  | ` | a | b | c | d  | e | f | g | h | i | j | k | l | m | n | o |
| 7x  | p | q | r | s | t  | u | v | w | x | y | z | { |   | } | ~ |   |

Unfortunately, as ASCII stands for American Standard Code for Information Interchange, it is designed for American needs. It does not include any of the special characters used in European languages, such as Ä, Ö, Ü, á, à, and others. There is no single standard for these "European extensions" of the ASCII set of characters—several different ones exist. The one used on the Internet and by most Windows programs is ISO 8859-1, a superset of the ASCII set of characters.

### 5.6.9.2 ISO 8859-1 Western Latin character set

emWin supports the ISO 8859-1, which defines characters as listed below:

| Code | Description   | Char |
|------|---|------|
| 160  | Non-breaking space                                    |      |
| 161  | Inverted exclamation mark                             | ¡    |
| 162  | Cent sign   | ¢    |
| 163  | Pound sign  | £    |
| 164  | Currency sign   | ₣    |
| 165  | Yen sign  | ¥    |
| 166  | Broken bar  | ¡    |
| 167  | Section sign  | §    |
| 168  | Diaeresis (Umlaut)                                    | ¨    |
| 169  | Copyright sign  | ©    |
| 170  | Feminine Ordinal Indicator                            | ª    |
| 171  | Left-pointing double angle quotation mark (Guillemet) | «    |
| 172  | Not sign  | ¬    |
| 173  | Soft hyphen   |      |
| 174  | Registered sign                                       | ®    |
| 175  | Macron accent   | ¯    |
| 176  | Degree symbol   | °    |
| 177  | Plus-minus sign                                       | ±    |
| 178  | Superscript two                                       | ²    |
| 179  | Superscript three                                     | ³    |
| 180  | Acute accent  | ´    |
| 181  | Micro sign  | µ    |
| 182  | Pilcrow sign  | ¶    |

| Code | Description  | Char         |
|------|--|--------------|
| 183  | Middle dot   | ·            |
| 184  | Cedilla  | ¸            |
| 185  | Superscript one  | <sup>1</sup> |
| 186  | Masculine ordinal indicator                            | º            |
| 187  | Right-pointing double angle quotation mark (Guillemet) | »            |
| 188  | Vulgar fraction one quarter                            | ¼            |
| 189  | Vulgar fraction one half                               | ½            |
| 190  | Vulgar fraction three quarters                         | ¾            |
| 191  | Inverted Question Mark                                 | ¿            |
| 192  | Latin Capital Letter A with grave                      | À            |
| 193  | Latin Capital letter A with acute                      | Á            |
| 194  | Latin Capital letter A with circumflex                 | Â            |
| 195  | Latin Capital letter A with tilde                      | Ã            |
| 196  | Latin Capital letter A with diaeresis                  | Ä            |
| 197  | Latin Capital letter A with ring above                 | Å            |
| 198  | Latin Capital letter Æ                                 | Æ            |
| 199  | Latin Capital letter C with cedilla                    | Ç            |
| 200  | Latin Capital letter E with grave                      | È            |
| 201  | Latin Capital letter E with acute                      | É            |
| 202  | Latin Capital letter E with circumflex                 | Ê            |
| 203  | Latin Capital letter E with diaeresis                  | Ë            |
| 204  | Latin Capital letter I with grave                      | Ì            |
| 205  | Latin Capital letter I with acute                      | Í            |
| 206  | Latin Capital letter I with circumflex                 | Î            |
| 207  | Latin Capital letter I with diaeresis                  | Ï            |
| 208  | Latin Capital letter Eth                               | Ð            |
| 209  | Latin Capital letter N with tilde                      | Ñ            |
| 210  | Latin Capital letter O with grave                      | Ò            |
| 211  | Latin Capital letter O with acute                      | Ó            |
| 212  | Latin Capital letter O with circumflex                 | Ô            |
| 213  | Latin Capital letter O with tilde                      | Õ            |
| 214  | Latin Capital letter O with diaeresis                  | Ö            |
| 215  | Multiplication sign                                    | ×            |
| 216  | Latin Capital letter O with stroke                     | Ø            |
| 217  | Latin Capital letter U with grave                      | Ù            |
| 218  | Latin Capital letter U with acute                      | Ú            |
| 219  | Latin Capital Letter U with circumflex                 | Û            |
| 220  | Latin Capital Letter U with diaeresis                  | Ü            |
| 221  | Latin Capital Letter Y with acute                      | Ý            |
| 222  | Latin Capital Letter Thorn                             | þ            |
| 223  | Latin Small Letter sharp S                             | ß            |
| 224  | Latin Small Letter A with grave                        | à            |
| 225  | Latin Small Letter A with acute                        | á            |

| Code | Description                          | Char |
|------|--------------------------------------|------|
| 226  | Latin Small Letter A with circumflex | â    |
| 227  | Latin Small Letter A with tilde      | ã    |
| 228  | Latin Small Letter A with diaeresis  | ä    |
| 229  | Latin Small Letter A with ring above | å    |
| 230  | Latin Small Letter Æ                 | æ    |
| 231  | Latin Small Letter C with cedilla    | ç    |
| 232  | Latin Small Letter E with grave      | è    |
| 233  | Latin Small Letter E with acute      | é    |
| 234  | Latin Small Letter E with circumflex | ê    |
| 235  | Latin Small Letter E with diaeresis  | ë    |
| 236  | Latin Small Letter I with grave      | ì    |
| 237  | Latin Small Letter I with acute      | í    |
| 238  | Latin Small Letter I with circumflex | î    |
| 239  | Latin Small Letter I with diaeresis  | ï    |
| 240  | Latin Small Letter Eth               | ð    |
| 241  | Latin Small Letter N with tilde      | ñ    |
| 242  | Latin Small Letter O with grave      | ò    |
| 243  | Latin Small Letter O with acute      | ó    |
| 244  | Latin Small Letter O with circumflex | ô    |
| 245  | Latin Small Letter O with tilde      | õ    |
| 246  | Latin Small Letter O with diaeresis  | ö    |
| 247  | Division sign                        | ÷    |
| 248  | Latin Small Letter O with stroke     | ø    |
| 249  | Latin Small Letter U with grave      | ù    |
| 250  | Latin Small Letter U with acute      | ú    |
| 251  | Latin Small Letter U with circumflex | û    |
| 252  | Latin Small Letter U with diaeresis  | ü    |
| 253  | Latin Small Letter Y with acute      | ý    |
| 254  | Latin Small Letter Thorn             | þ    |
| 255  | Latin Small Letter Y with diaeresis  | ÿ    |

### 5.6.9.3 Unicode

Unicode is the ultimate in character coding. It is an international standard based on ASCII and ISO 8859-1. Contrary to ASCII, UNICODE requires 16-bit characters because all characters have their own code. Currently, more than 30,000 different characters are defined. However, not all of the character images are defined in emWin. It is the responsibility of the user to define these additional characters.

## 5.6.10 Standard fonts

emWin is shipped with a selection of fonts which should cover most of your needs. The standard font package contains monospaced and proportional fonts in different sizes and styles. **Monospaced fonts** are fonts with a fixed character width, in which all characters have the same width in pixels. **Proportional fonts** are fonts in which each character has its own individual pixel-width. The following sections provide an overview of emWin standard fonts.

### 5.6.10.1 Font identifier naming convention

All standard fonts are named as follows. The components of the naming convention are explained in the table below:

```
GUI_Font[<style>][<width>x]<height>[x<MagX>x<MagY>][H][B][_<characterset>]
```

| Element        | Description   |
|----------------|---|
| GUI_Font       | Standard prefix for all fonts shipped with emWin.   |
| <style>        | Specifies a non-standard font style. Example: Comic style in GUI_FontComic18B_ASCII.  |
| <width>        | Width of characters, contained only in monospaced fonts.  |
| <height>       | Height of the font in pixels.   |
| <MagX>         | Factor of magnification in X, contained only in magnified fonts.  |
| <MagY>         | Factor of magnification in Y, contained only in magnified fonts.  |
| H              | Abbreviation for "high". Only used if there is more than one font with the same height. It means that the font appears "higher" than other fonts.   |
| B              | Abbreviation for "bold". Used in bold fonts.  |
| <characterset> | Specifies the contents of characters:<br>ASCII: Only ASCII characters 0x20-0x7E (0x7F).<br>1: ASCII characters and European extensions 0xA0 - 0xFF.<br>HK: Hiragana and Katakana.<br>1HK: ASCII, European extensions, Hiragana and Katakana.<br>D: Digit fonts, character set: +-.0123456789. |

#### Example 1

```
GUI_Font16_ASCII
```

| Element  | Description                          |
|----------|--------------------------------------|
| GUI_Font | Standard font prefix.                |
| 16       | Height in pixels.                    |
| ASCII    | Font contains ASCII characters only. |

#### Example 2

```
GUI_Font8x15B_ASCII
```

| Element  | Description                          |
|----------|--------------------------------------|
| GUI_Font | Standard font prefix.                |
| 8        | Width of characters.                 |
| x15      | Height in pixels.                    |
| B        | Bold font.                           |
| ASCII    | Font contains ASCII characters only. |

### Example 3

GUI\_Font8x16x1x2

| Element  | Description                |
|----------|----------------------------|
| GUI_Font | Standard font prefix.      |
| 8        | Width of characters.       |
| x16      | Height in pixels.          |
| x1       | Magnification factor in X. |
| x2       | Magnification factor in Y. |

#### 5.6.10.2 Font file naming convention

The names for the font files are similar to the names of the fonts themselves. The files are named as follows:

```
F[<width>]<height>[H][B][<characterset>]
```

| Element        | Description   |
|----------------|---|
| F              | Standard prefix for all fonts files shipped with emWin.   |
| <width>        | Width of characters, contained only in monospaced fonts.  |
| <height>       | Height of the font in pixels.   |
| H              | Abbreviation for "high". Only used if there is more than one font with the same height. It means that the font appears "higher" than other fonts.   |
| B              | Abbreviation for "bold". Used in bold fonts.  |
| <characterset> | Specifies the contents of characters:<br>ASCII: Only ASCII characters 0x20-0x7E (0x7F).<br>1: ASCII characters and European extensions 0xA0 - 0xFF.<br>HK: Hiragana and Katakana.<br>1HK: ASCII, European extensions, Hiragana and Katakana.<br>D: Digit fonts. |

#### 5.6.10.3 Measurement, ROM-size and character set of fonts

The following sections describe the standard fonts shipped with emWin. For each font there is a measurement diagram, an overview of all characters included and a table containing the ROM size in bytes and the font files required for use.

The following parameters are used in the measurement diagrams:

| Element | Description  |
|---------|--|
| F       | Size of font in Y.   |
| B       | Distance of base line from the top of the font.              |
| C       | Height of capital characters.                                |
| L       | Height of lowercase characters.                              |
| U       | Size of underlength used by letters such as "g", "j" or "y". |

#### 5.6.10.4 Proportional fonts

##### 5.6.10.4.1 Overview

The following screenshot gives an overview of all available proportional fonts:

|                        |               |
|------------------------|---------------|
| GUI_Font8_ASCII        | +ABCg         |
| GUI_Font8_1            | +ABCg         |
| GUI_Font10S_ASCII      | +ABCg         |
| GUI_Font10S_1          | +ABCg         |
| GUI_Font10_ASCII       | +ABCg         |
| GUI_Font10_1           | +ABCg         |
| GUI_Font13_ASCII       | +ABCg         |
| GUI_Font13_1           | +ABCg         |
| GUI_Font13B_ASCII      | + <b>ABCg</b> |
| GUI_Font13B_1          | + <b>ABCg</b> |
| GUI_Font13H_ASCII      | +ABCg         |
| GUI_Font13H_1          | +ABCg         |
| GUI_Font13HB_ASCII     | + <b>ABCg</b> |
| GUI_Font13HB_1         | + <b>ABCg</b> |
| GUI_Font16_ASCII       | +ABCg         |
| GUI_Font16_1           | +ABCg         |
| GUI_Font16_HK          | +あぶエラ         |
| GUI_Font16_1HK         | +ABCg         |
| GUI_Font16B_ASCII      | + <b>ABCg</b> |
| GUI_Font16B_1          | + <b>ABCg</b> |
| GUI_FontConic18B_ASCII | + <b>ABCg</b> |
| GUI_FontConic18B_1     | + <b>ABCg</b> |
| GUI_Font20_ASCII       | +ABCg         |
| GUI_Font20_1           | +ABCg         |
| GUI_Font20B_ASCII      | + <b>ABCg</b> |
| GUI_Font20B_1          | + <b>ABCg</b> |
| GUI_Font24_ASCII       | +ABCg         |
| GUI_Font24_1           | +ABCg         |
| GUI_Font24B_ASCII      | + <b>ABCg</b> |
| GUI_Font24B_1          | + <b>ABCg</b> |
| GUI_FontConic24B_ASCII | + <b>ABCg</b> |
| GUI_FontConic24B_1     | + <b>ABCg</b> |
| GUI_Font32_ASCII       | +ABCg         |
| GUI_Font32_1           | +ABCg         |
| GUI_Font32B_ASCII      | + <b>ABCg</b> |
| GUI_Font32B_1          | + <b>ABCg</b> |

#### 5.6.10.4.2 Font details

The following table shows the measurement, ROM size and used files of the fonts:

| Font name              | Measurement                      | ROM size in bytes           | Used files                                      |
|------------------------|----------------------------------|-----------------------------|---|
| GUI_Font8_ASCII        | F: 8, B: 7, C: 7, L: 5, U: 1     | 1562                        | F08_ASCII.c                                     |
| GUI_Font8_1            | F: 8, B: 7, C: 7, L: 5, U: 1     | 1562 + 1586                 | F08_ASCII.c<br>F08_1.c                          |
| GUI_Font10_ASCII       | F: 10, B: 9, C: 8, L: 6, U: 1    | 1800                        | F10_ASCII.c                                     |
| GUI_Font10_1           | F: 10, B: 9, C: 8, L: 6, U: 1    | 1800 + 2456                 | F10_ASCII.c<br>F10_1.c                          |
| GUI_Font10S_ASCII      | F: 10, B: 8, C: 6, L: 4, U: 2    | 1760                        | F10S_ASCII.c                                    |
| GUI_Font10S_1          | F: 10, B: 8, C: 6, L: 4, U: 2    | 1760 + 1770                 | F10S_ASCII.c<br>F10S_1.c                        |
| GUI_Font13_ASCII       | F: 13, B: 11, C: 8, L: 6, U: 2   | 2076                        | F13_ASCII.c                                     |
| GUI_Font13_1           | F: 13, B: 11, C: 8, L: 6, U: 2   | 2076 + 2149                 | F13_ASCII.c<br>F13_1.c                          |
| GUI_Font13B_ASCII      | F: 13, B: 11, C: 8, L: 6, U: 2   | 2222                        | F13B_ASCII.c                                    |
| GUI_Font13B_1          | F: 13, B: 11, C: 8, L: 6, U: 2   | 2222 + 2216                 | F13B_ASCII.c<br>F13B_1.c                        |
| GUI_Font13H_ASCII      | F: 13, B: 11, C: 9, L: 7, U: 2   | 2232                        | F13H_ASCII.c                                    |
| GUI_Font13H_1          | F: 13, B: 11, C: 9, L: 7, U: 2   | 2232 + 2291                 | F13H_ASCII.c<br>F13H_1.c                        |
| GUI_Font13HB_ASCII     | F: 13, B: 11, C: 9, L: 7, U: 2   | 2690                        | F13HB_ASCII.c                                   |
| GUI_Font13HB_1         | F: 13, B: 11, C: 9, L: 7, U: 2   | 2690 + 2806                 | F13HB_ASCII.c<br>F13HB_1.c                      |
| GUI_Font16_ASCII       | F: 16, B: 13, C: 10, L: 7, U: 3  | 2714                        | F16_ASCII.c                                     |
| GUI_Font16_1           | F: 16, B: 13, C: 10, L: 7, U: 3  | 2714 + 3850                 | F16_ASCII.c<br>F16_1.c                          |
| GUI_Font16_HK          | F: 16, B: 13, C: 10, L: 7, U: 3  | 6950                        | F16_HK.c  |
| GUI_Font16_1HK         | F: 16, B: 13, C: 10, L: 7, U: 3  | 120 + 6950 +<br>2714 + 3850 | F16_1HK.c<br>F16_HK.c<br>F16_ASCII.c<br>F16_1.c |
| GUI_Font16B_ASCII      | F: 16, B: 13, C: 10, L: 7, U: 3  | 2690                        | F16B_ASCII.c                                    |
| GUI_Font16B_1          | F: 16, B: 13, C: 10, L: 7, U: 3  | 2690 + 2790                 | F16B_ASCII.c<br>F16B_1.c                        |
| GUI_FontComic18B_ASCII | F: 18, B: 15, C: 12, L: 9, U: 3  | 3572                        | FCComic18B_ASCII.c                              |
| GUI_FontComic18B_1     | F: 18, B: 15, C: 12, L: 9, U: 3  | 3572 + 4334                 | FCComic18B_ASCII.c<br>FCComic18B_1.c            |
| GUI_Font20_ASCII       | F: 20, B: 16, C: 13, L: 10, U: 4 | 4044                        | F20_ASCII.c                                     |
| GUI_Font20_1           | F: 20, B: 16, C: 13, L: 10, U: 4 | 4044 + 4244                 | F20_ASCII.c<br>F20_1.c                          |
| GUI_Font20B_ASCII      | F: 20, B: 16, C: 13, L: 10, U: 4 | 4164                        | F20B_ASCII.c                                    |
| GUI_Font20B_1          | F: 20, B: 16, C: 13, L: 10, U: 4 | 4164 + 4244                 | F20B_ASCII.c<br>F20B_1.c                        |
| GUI_Font24_ASCII       | F: 24, B: 20, C: 17, L: 13, U: 4 | 4786                        | F24_ASCII.c                                     |
| GUI_Font24_1           | F: 24, B: 20, C: 17, L: 13, U: 4 | 4786 + 5022                 | F24_ASCII.c<br>F24_1.c                          |
| GUI_Font24B_ASCII      | F: 24, B: 19, C: 15, L: 11, U: 5 | 4858                        | F24B_ASCII.c                                    |
| GUI_Font24B_1          | F: 24, B: 19, C: 15, L: 11, U: 5 | 4858 + 5022                 | F24B_ASCII.c<br>F24B_1.c                        |



| Font name              | Measurement                      | ROM size in bytes | Used files                         |
|------------------------|----------------------------------|-------------------|------------------------------------|
| GUI_FontComic24B_ASCII | F: 24, B: 20, C: 17, L: 13, U: 4 | 6146              | FComic24B_ASCII.c                  |
| GUI_FontComic24B_1     | F: 24, B: 20, C: 17, L: 13, U: 4 | 6146 + 5598       | FComic24B_ASCII.c<br>FComic24B_1.c |
| GUI_Font32_ASCII       | F: 32, B: 26, C: 20, L: 15, U: 6 | 7234              | F32_ASCII.c                        |
| GUI_Font32_1           | F: 32, B: 26, C: 20, L: 15, U: 6 | 7234 + 7734       | F32_ASCII.c<br>F32_1.c             |
| GUI_Font32B_ASCII      | F: 32, B: 25, C: 20, L: 15, U: 7 | 7842              | F32B_ASCII.c                       |
| GUI_Font32B_1          | F: 32, B: 25, C: 20, L: 15, U: 7 | 7842 + 8118       | F32B_ASCII.c<br>F32B_1.c           |

### 5.6.10.4.3 Characters

The following shows all characters of all proportional standard fonts:

#### GUI\_Font8\_ASCII

```
!"#$%&'()*+,-./0123456789;:<=>?@ABCDEFGHIJKLMNPOQRSTUVWXYZ[\]^_`abcdefghijklmnopqrstuvwxyz{|}~
```

#### GUI\_Font8\_1

```
!"#$%&'()*+,-./0123456789;:<=>?@ABCDEFGHIJKLMNPOQRSTUVWXYZ[\]^_`abcdefghijklmnopqrstuvwxyz{|}~ ¡¢£¥¦§¨ª«¬®¯°±²³´µ¶·¸¹º»¼½¾¿ÀÁÂÃÄÅÆÇÈÉÊËÌÍÎÏÐÑÒÓÔÕÖ×ØÙÚÛÜÝÞßàáâãäåæçèéêëìíîïðñóôõö÷øùúûüýþÿ
```

#### GUI\_Font10\_ASCII

```
!"#$%&'()*+,-./0123456789;:<=>?@ABCDEFGHIJKLMNPOQRSTUVWXYZ[\]^_`abcdefghijklmnopqrstuvwxyz{|}~
```

#### GUI\_Font10\_1

```
!"#$%&'()*+,-./0123456789;:<=>?@ABCDEFGHIJKLMNPOQRSTUVWXYZ[\]^_`abcdefghijklmnopqrstuvwxyz{|}~ ¡¢£¥¦§¨ª«¬®¯°±²³´µ¶·¸¹º»¼½¾¿ÀÁÂÃÄÅÆÇÈÉÊËÌÍÎÏÐÑÒÓÔÕÖ×ØÙÚÛÜÝÞßàáâãäåæçèéêëìíîïðñóôõö÷øùúûüýþÿ
```

#### GUI\_Font10S\_ASCII

```
!"#$%&'()*+,-./0123456789;:<=>?@ABCDEFGHIJKLMNPOQRSTUVWXYZ[\]^_`abcdefghijklmnopqrstuvwxyz{|}~
```

#### GUI\_Font10S\_1

```
!"#$%&'()*+,-./0123456789;:<=>?@ABCDEFGHIJKLMNPOQRSTUVWXYZ[\]^_`abcdefghijklmnopqrstuvwxyz{|}~ ¡¢£¥¦§¨ª«¬®¯°±²³´µ¶·¸¹º»¼½¾¿ÀÁÂÃÄÅÆÇÈÉÊËÌÍÎÏÐÑÒÓÔÕÖ×ØÙÚÛÜÝÞßàáâãäåæçèéêëìíîïðñóôõö÷øùúûüýþÿ
```

#### GUI\_Font13\_ASCII

```
!"#$%&'()*+,-./0123456789;:<=>?@ABCDEFGHIJKLMNPOQRSTUVWXYZ[\]^_`abcdefghijklmnopqrstuvwxyz{|}~
```

#### GUI\_Font13\_1

```
!"#$%&'()*+,-./0123456789;:<=>?@ABCDEFGHIJKLMNPOQRSTUVWXYZ[\]^_`abcdefghijklmnopqrstuvwxyz{|}~ ¡¢£¥¦§¨ª«¬®¯°±²³´µ¶·¸¹º»¼½¾¿ÀÁÂÃÄÅÆÇÈÉÊËÌÍÎÏÐÑÒÓÔÕÖ×ØÙÚÛÜÝÞßàáâãäåæçèéêëìíîïðñóôõö÷øùúûüýþÿ
```

**GUI\_Font13B\_ASCII**

!"#\$%&'()\*+,-./0123456789;<=>?@ABCDEFGHIJKLMN  
OPQRSTUVWXYZ[\]^\_`abcdefghijklmnopqrstuvwxyz{|}  
~

**GUI\_Font13B\_1**

!"#\$%&'()\*+,-./0123456789;<=>?@ABCDEFGHIJKLMN  
OPQRSTUVWXYZ[\]^\_`abcdefghijklmnopqrstuvwxyz{|}  
~ ¡¢£¥¦§¨©ª«¬®¯°±²³´µ¶·¸¹º»¼½¾¿ÀÁÂÃÄÅÆÇÈÉÊ  
ËÌÍÎÏÐÑÒÓÔÕÖ×ØÙÚÛÜÝÞßàáâãäåæçèéêëìíîïðñóôõö÷ø  
ùúûüýþÿ

**GUI\_Font13H\_ASCII**

!"#\$%&'()\*+,-./0123456789;<=>?@ABCDEFGHIJKLM  
NOPQRSTUVWXYZ[\]^\_`abcdefghijklmnopqrstuvwxyz{|  
}~

**GUI\_Font13H\_1**

!"#\$%&'()\*+,-./0123456789;<=>?@ABCDEFGHIJKLM  
NOPQRSTUVWXYZ[\]^\_`abcdefghijklmnopqrstuvwxyz{|  
}~ ¡¢£¥¦§¨©ª«¬®¯°±²³´µ¶·¸¹º»¼½¾¿ÀÁÂÃÄÅÆÇ  
ÈÉÊËÌÍÎÏÐÑÒÓÔÕÖ×ØÙÚÛÜÝÞßàáâãäåæçèéêëìíîïðñóôõ  
ö÷øùúûüýþÿ

**GUI\_Font13HB\_ASCII**

!"#\$%&'()\*+,-./0123456789;<=>?@ABCDEFGHI  
JKLMNOPQRSTUVWXYZ[\]^\_`abcdefghijklmnopq  
rstuvwxyz{|}~

**GUI\_Font13HB\_1**

!"#\$%&'()\*+,-./0123456789;<=>?@ABCDEFGHI  
JKLMNOPQRSTUVWXYZ[\]^\_`abcdefghijklmnopq  
rstuvwxyz{|}~ ¡¢£¥¦§¨©ª«¬®¯°±²³´µ¶·¸¹º»  
¼½¾¿ÀÁÂÃÄÅÆÇÈÉÊËÌÍÎÏÐÑÒÓÔÕÖ×ØÙÚÛÜÝÞ  
ßàáâãäåæçèéêëìíîïðñóôõö÷øùúûüýþÿ

**GUI\_Font16\_ASCII**

!"#\$%&'()\*+,-./0123456789;<=>?@ABCDEFGHIJKLM  
NOPQRSTUVWXYZ[\]^\_`abcdefghijklmnopqrstuvwxyz{|}  
~

**GUI\_Font16\_1**

!"#\$%&'()\*+,-./0123456789;<=>?@ABCDEFGHIJKLM  
NOPQRSTUVWXYZ[\]^\_`abcdefghijklmnopqrstuvwxyz{|}  
~ ¡¢£¥¦§¨©ª«¬®¯°±²³´µ¶·¸¹º»¼½¾¿ÀÁÂÃÄÅÆÇÈÉÊ  
ËÌÍÎÏÐÑÒÓÔÕÖ×ØÙÚÛÜÝÞßàáâãäåæçèéêëìíîïðñóôõö  
÷øùúûüýþÿ

GUI\_Font16\_HK

```

ああいううええおおかがきぎくぐげげごご
さざしじすずせぜそぞただちぢっつづてでと
どなにぬねのはばばひびびふぶぶへべべほぼ
ぼまみむめもややゆゆよよらりるれろわわゐ
ゑをんァアイイウウエエオオカガキギクグケ
ゲゴゴサザシジスズセゼソゾタダチヂッツツ
テテトトナニヌネノハババヒビビフブブヘベ
ベホボボマミムメモヤヤユユヨヨラリルレロ
ワヰヱヰンヴカケ

```

GUI\_Font16\_1HK

```

!"#$%&'()*+,-./0123456789:;<=>?@ABCDEFGHIJKLM
NOPQRSTUVWXYZ[\]^_`abcdefghijklmnopqrstuvwxyz{|}
~ ¡¢£¥¦§¨ª«¬®¯°±²³´µ¶·¸¹º»¼½¾¿ÀÁÂÃÄÅÆÇÈÉÊË
ËÏÎÏÑÒÓÔÕÖ×ØÙÚÛÜÝÞßàáâãääåæçèéêëìíîïðñòóôõö
÷øùúûüýþÿ ああいううええおおかがきぎくぐ
げげごごさざしじすずせぜそぞただちぢっつ
づてでとどなにぬねのはばばひびびふぶぶへ
べべほぼぼまみむめもややゆゆよよらりるれ
ろわわゐゑをんァアイイウウエエオオカガキ
ギクグケゲゴゴサザシジスズセゼソゾタダチ
ヂッツツツテテトトナニヌネノハババヒビビフ
ブブヘベベホボボマミムメモヤヤユユヨヨラ
リルレロワヰヱヰンヴカケ

```

GUI\_Font16B\_ASCII

```

!"#$%&'()*+,-./0123456789:;<=>?@ABCDEFGHIJKLM
NOPQRSTUVWXYZ[\]^_`abcdefghijklmnopqrstuvwxyz
xyz{~

```

GUI\_Font16B\_1

```

!"#$%&'()*+,-./0123456789:;<=>?@ABCDEFGHIJKLM
NOPQRSTUVWXYZ[\]^_`abcdefghijklmnopqrstuvwxyz
xyz{~ ¡¢£¥¦§¨ª«¬®¯°±²³´µ¶·¸¹º»¼½¾¿ÀÁÂÃÄÅÆ
ÇÈÉÊËÏÎÏÑÒÓÔÕÖ×ØÙÚÛÜÝÞßàáâãääåæçèéêëìíîï
ðñòóôõö÷øùúûüýþÿ

```

GUI\_FontComic18B\_ASCII

```

!"#$%&'()*+,-./0123456789:;<=>?@ABCD
EFGHIJKLMNOPQRSTUVWXYZ[\]^_`ab
cdefghijklmnopqrstuvwxyz{|}~€

```

GUI\_FontComic18B\_1

```

!"#$%&'()*+,-./0123456789:;<=>?@ABCD
EFGHIJKLMNOPQRSTUVWXYZ[\]^_`ab
cdefghijklmnopqrstuvwxyz{|}~ ¡¢£¥¦§¨ª«¬®¯°±²³´µ¶·¸¹º»¼½¾¿ÀÁÂÃÄÅÆÇ
ÈÉÊËÏÎÏÑÒÓÔÕÖ×ØÙÚÛÜÝÞßàáâãääåæçèéêëìíîïðñòóôõö÷øùúûüýþÿ

```

GUI\_Font20\_ASCII

!"#\$%&'()\*+,-./0123456789:;<=>?@AB  
CDEFGHIJKLMNOPQRSTUVWXYZ[\]^  
\_`abcdefghijklmnopqrstuvwxyz{|}~

GUI\_Font20\_1

!"#\$%&'()\*+,-./0123456789:;<=>?@AB  
CDEFGHIJKLMNOPQRSTUVWXYZ[\]^  
\_`abcdefghijklmnopqrstuvwxyz{|}~ ¡¢£  
¥¦§¨ª«¬®¯°±²³´µ¶·¸¹º»¼½¾¿ÀÁÂÃÄÅ  
ÆÇÈÉÊËÌÍÎÏÐÑÒÓÔÕÖ×ØÙÚÛÜÝÞßà  
áâãääåæçèéêëìíîïðñòóôõ÷øùúûüýþÿ

GUI\_Font20B\_ASCII

!"#\$%&'()\*+,-./0123456789:;<=>?@A  
BCDEFGHIJKLMNOPQRSTUVWXYZ[  
\]^\_`abcdefghijklmnopqrstuvwxyz{|}  
~

GUI\_Font20B\_1

!"#\$%&'()\*+,-./0123456789:;<=>?@A  
BCDEFGHIJKLMNOPQRSTUVWXYZ[  
\]^\_`abcdefghijklmnopqrstuvwxyz{|}  
~ ¡¢£  
¥¦§¨ª«¬®¯°±²³´µ¶·¸¹º»¼½¾¿À  
ÁÂÃÄÅÆÇÈÉÊËÌÍÎÏÐÑÒÓÔÕÖ×ØÙ  
ÚÛÜÝÞßàáâãääåæçèéêëìíîïðñòó  
ôõ÷øùúûüýþÿ

GUI\_Font24\_ASCII

!"#\$%&'()\*+,-./0123456789:;<=>?  
@ABCDEFGHIJKLMNOPQRSTU  
VWXYZ[\]^\_`abcdefghijklmnopqrst  
uvwxyz{|}~

GUI\_Font24\_1

!"#\$%&'()\*+,-./0123456789:;<=>?  
@ABCDEFGHIJKLMNOPQRSTU  
VWXYZ[\]^\_`abcdefghijklmnopqrst  
uvwxyz{|}~ ¡¢£  
¥¦§¨ª«¬®¯°±²³´µ¶·¸¹º»¼½¾¿À  
ÁÂÃÄÅÆÇÈÉÊËÌÍÎÏÐÑÒÓÔÕÖ×ØÙ  
ÚÛÜÝÞßàáâãääåæçèéêëìíîïðñòó  
ôõ÷øùúûüýþÿ

GUI\_Font24B\_ASCII

!"#\$%&'()\*+,-./0123456789:;<=>
?@ABCDEFGHIJKLMNQRST
UVWXYZ[\]^\_`abcdefghijklmnop
qrstuvwxyz{|}~

GUI\_Font24B\_1

!"#\$%&'()\*+,-./0123456789:;<=>
?@ABCDEFGHIJKLMNQRST
UVWXYZ[\]^\_`abcdefghijklmnop
qrstuvwxyz{|}~ ¡¢£¥¦§¨ª«¬®¯
°±²³´µ¶·¸¹º»¼½¾¿ÀÁÂÃÄÅÆÇÈ
ÉÊËÌÍÎÏÐÑÒÓÔÕÖ×ØÙÚÛÜÝÞßàá
âãääåæçèéêëìíîïðñòóôõö÷øùúûü
ýþÿ

GUI\_FontComic24B\_ASCII

!"#\$%&'()\*+,-./0123456789:
;<=>?@ABCDEFGHIJKLMNPO
QRSTUVWXYZ[\]^\_`abcdefghi
jklmnopqrstuvwxyz{|}~

GUI\_FontComic24B\_1

!"#\$%&'()\*+,-./0123456789:
;<=>?@ABCDEFGHIJKLMNPO
QRSTUVWXYZ[\]^\_`abcdefghi
jklmnopqrstuvwxyz{|}~ ¡¢£¥¦§¨ª«¬®¯
°±²³´µ¶·¸¹º»¼½¾¿ÀÁÂÃÄÅÆÇÈÉÊËÌÍÎÏÐÑÒÓÔ
ÕÖ×ØÙÚÛÜÝÞßàáâãääåæçèéêëìíîïðñòóôõö÷øùúûüýþÿ

GUI\_Font32\_ASCII

!"#\$%&'()\*+,-./012345678
9:;<=>?@ABCDEFGHIJK
LMNOPQRSTUVWXYZ[\]^\_`abcdefghijklmnopqrstu
vwxyz{|}~

GUI\_Font32\_1

!"#\$%&'()\*+,-./012345678  
 9:;<=>?@ABCDEFGHIJK  
 LMNOPQRSTUVWXYZ[\  
 ^\_`abcdefghijklmnopqrstu  
 vxyz{|}~ ¡¢£¤¥¦§¨©ª«¬®¯°  
 ±²³´µ¶·¸¹º»¼½¾¿ÀÁÂÃÄÅ  
 ÆÇÈÉÊËÌÍÎÏÐÑÒÓÔÕÖ×  
 ØÙÚÛÜÝÞßàáâãääåæçèé  
 êëìíîïðñòóôõö÷øùúûüýþÿ

GUI\_Font32B\_ASCII

**!"#\$%&'()\*+,-./01234567  
 89:;<=>?@ABCDEFGHIJK  
 KLMNOPQRSTUVWXYZ[  
 \]^\_`abcdefghijklmnopq  
 rstuvwxyz{|}~**

GUI\_Font32B\_1

**!"#\$%&'()\*+,-./01234567  
 89:;<=>?@ABCDEFGHIJK  
 KLMNOPQRSTUVWXYZ[  
 \]^\_`abcdefghijklmnopq  
 rstuvwxyz{|}~ ¡¢£¤¥¦§¨©ª«¬®¯°  
 ±²³´µ¶·¸¹º»¼½¾¿À  
 ÁÂÃÄÅÆÇÈÉÊËÌÍÎÏÐ  
 ÑÒÓÔÕÖ×ØÙÚÛÜÝÞßà  
 áâãääåæçèéêëìíîïðñ  
 òóôõö÷øùúûüýþÿ**

### 5.6.10.5 Proportional fonts, framed

#### 5.6.10.5.1 Overview

The following screenshot shows the currently available framed proportional fonts:



#### 5.6.10.5.2 Font details

The following table shows the measurement, ROM size and used file of the font:

| Font name         | Measurement                      | ROM size in bytes | Used files   |
|-------------------|----------------------------------|-------------------|--------------|
| GUI_Font20F_ASCII | F: 20, B: 19, C: 19, L: 19, U: 1 | 5248              | F20F_ASCII.c |

#### 5.6.10.5.3 Characters

The following shows all characters of the font:

##### GUI\_Font20F\_ASCII

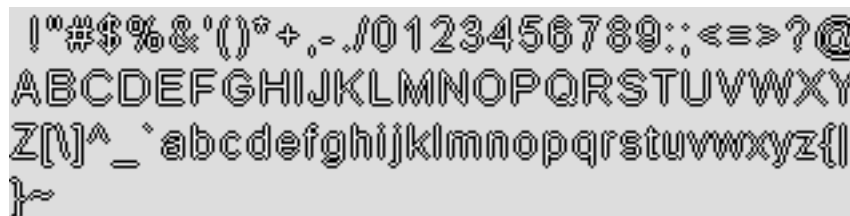

### 5.6.10.6 Monospaced fonts

#### 5.6.10.6.1 Overview

The following screenshot gives an overview of all available monospaced fonts:

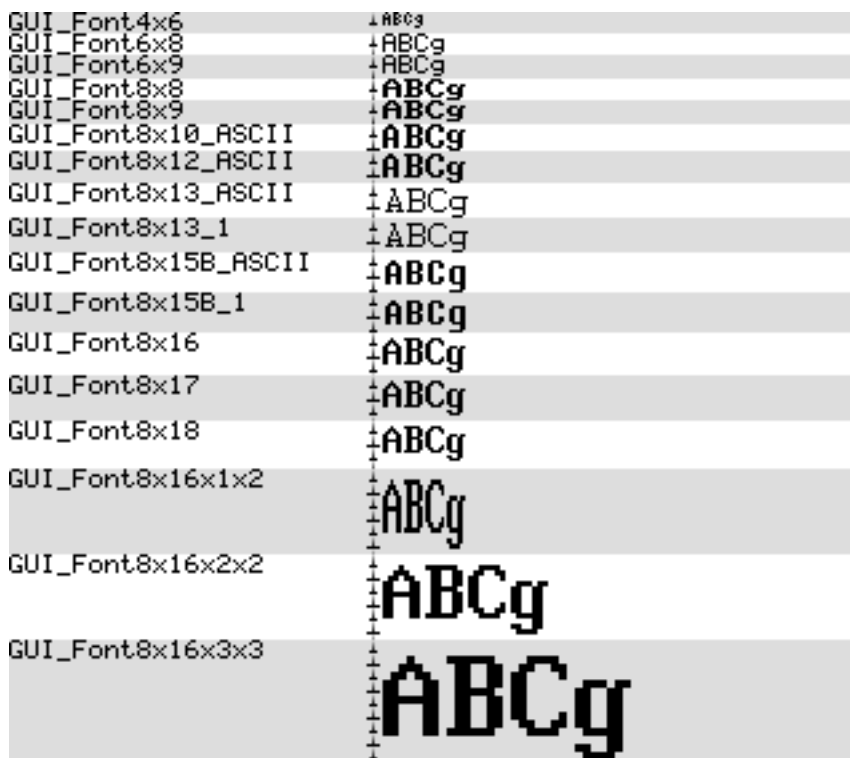

### 5.6.10.6.2 Font details

The following table shows the measurement, ROM size and used files of the fonts:

| Font name           | Measurement                       | ROM size in bytes                        | Used files                   |
|---------------------|-----------------------------------|--|------------------------------|
| GUI_Font4x6         | F: 6, B: 5, C: 5, L: 4, U: 1      | 620                                      | F4x6.c                       |
| GUI_Font6x8         | F: 8, B: 7, C: 7, L: 5, U: 1      | 1840                                     | F6x8.c                       |
| GUI_Font6x8_ASCII   | F: 8, B: 7, C: 7, L: 5, U: 1      | 1568                                     | F6x8_ASCII.c                 |
| GUI_Font6x8_1       | F: 8, B: 7, C: 7, L: 5, U: 1      | 1568 + 1584                              | F6x8_ASCII.c<br>F6x8_1.c     |
| GUI_Font6x9         | F: 9, B: 7, C: 7, L: 5, U: 2      | 1840 (same ROM location as GUI_Font8x16) | F6x8.c                       |
| GUI_Font8x8         | F: 8, B: 7, C: 7, L: 5, U: 1      | 1840                                     | F8x8.c                       |
| GUI_Font8x8_ASCII   | F: 8, B: 7, C: 7, L: 5, U: 1      | 1568                                     | F8x8_ASCII.c                 |
| GUI_Font8x8_1       | F: 8, B: 7, C: 7, L: 5, U: 1      | 1568 + 1584                              | F8x8_ASCII.c<br>F8x8_1.c     |
| GUI_Font8x9         | F: 9, B: 7, C: 7, L: 5, U: 2      | 1840 (same ROM location as GUI_Font8x16) | F8x8.c                       |
| GUI_Font8x10_ASCII  | F: 10, B: 9, C: 9, L: 7, U: 1     | 1770                                     | F8x10_ASCII.c                |
| GUI_Font8x12_ASCII  | F: 12, B: 10, C: 9, L: 6, U: 2    | 1962                                     | F8x12_ASCII.c                |
| GUI_Font8x13_ASCII  | F: 13, B: 11, C: 9, L: 6, U: 2    | 2058                                     | F8x13_ASCII.c                |
| GUI_Font8x13_1      | F: 13, B: 11, C: 9, L: 6, U: 2    | 2058 + 2070                              | F8x13_ASCII.c<br>F8x13_1.c   |
| GUI_Font8x15B_ASCII | F: 15, B: 12, C: 9, L: 7, U: 3    | 2250                                     | F8x15_ASCII.c                |
| GUI_Font8x15B_1     | F: 15, B: 12, C: 9, L: 7, U: 3    | 2250 + 2262                              | F8x15B_ASCII.c<br>F8x15B_1.c |
| GUI_Font8x16        | F: 16, B: 12, C: 10, L: 7, U: 4   | 3304                                     | F8x16.c                      |
| GUI_Font8x17        | F: 17, B: 12, C: 10, L: 7, U: 5   | 3304 (same ROM location as GUI_Font8x16) | F8x16.c                      |
| GUI_Font8x18        | F: 18, B: 12, C: 10, L: 7, U: 6   | 3304 (same ROM location as GUI_Font8x16) | F8x16.c                      |
| GUI_Font8x16x1x2    | F: 32, B: 24, C: 20, L: 14, U: 8  | 3304 (same ROM location as GUI_Font8x16) | F8x16.c                      |
| GUI_Font8x16x2x2    | F: 32, B: 24, C: 20, L: 14, U: 8  | 3304 (same ROM location as GUI_Font8x16) | F8x16.c                      |
| GUI_Font8x16x3x3    | F: 48, B: 36, C: 30, L: 21, U: 12 | 3304 (same ROM location as GUI_Font8x16) | F8x16.c                      |
| GUI_Font8x16_ASCII  | F: 16, B: 12, C: 10, L: 7, U: 4   | 3572 + 4334                              | F8x16_ASCII.c                |
| GUI_Font8x16_1      | F: 16, B: 12, C: 10, L: 7, U: 4   | 4044                                     | F8x16_ASCII.c<br>F8x16_1.c   |

### 5.6.10.6.3 Characters

The following shows all characters of all monospaced standard fonts:



GUI\_Font4x6

!'"#%&'()\*+,-./0123456789:;<=>?@ABCDEFGHIJKLMNopqrstuvwxyz[\]^\_`abcdefghijklmnopqrstuvwxyz{|}~

GUI\_Font6x8

!'"#%&'()\*+,-./0123456789:;<=>?@ABCDEFGHIJKLMNopqrstuvwxyz[\]^\_`abcdefghijklmnopqrstuvwxyz{|}~

GUI\_Font6x8\_ASCII

!'"#%&'()\*+,-./0123456789:;<=>?@ABCDEFGHIJKLMNopqrstuvwxyz[\]^\_`abcdefghijklmnopqrstuvwxyz{|}~

GUI\_Font6x8\_1

!'"#%&'()\*+,-./0123456789:;<=>?@ABCDEFGHIJKLMNopqrstuvwxyz[\]^\_`abcdefghijklmnopqrstuvwxyz{|}~

GUI\_Font6x9

!'"#%&'()\*+,-./0123456789:;<=>?@ABCDEFGHIJKLMNopqrstuvwxyz[\]^\_`abcdefghijklmnopqrstuvwxyz{|}~

GUI\_Font8x8

!'"#\$%&'()\*+,-./0123456789:;<=>?@ABCDEFGHIJKLMNopqrstuvwxyz[\]^\_`abcdefghijklmnopqrstuvwxyz{|}~

GUI\_Font8x8\_ASCII

!'"#\$%&'()\*+,-./0123456789:;<=>?@ABCDEFGHIJKLMNopqrstuvwxyz[\]^\_`abcdefghijklmnopqrstuvwxyz{|}~

GUI\_Font8x8\_1

!'"#\$%&'()\*+,-./0123456789:;<=>?@ABCDEFGHIJKLMNopqrstuvwxyz[\]^\_`abcdefghijklmnopqrstuvwxyz{|}~

GUI\_Font8x9

!'"#\$%&'()\*+,-./0123456789:;<=>?@ABCDEFGHIJKLMNopqrstuvwxyz[\]^\_`abcdefghijklmnopqrstuvwxyz{|}~

GUI\_Font8x10\_ASCII

!'"#\$%&'()\*+,-./0123456789:;<=>?@ABCDEFGHIJKLMNopqrstuvwxyz[\]^\_`abcdefghijklmnopqrstuvwxyz{|}~

GUI\_Font8x12\_ASCII

!'"#\$%&'()\*+,-./0123456789:;<=>?@ABCDEFGHIJKLMNopqrstuvwxyz[\]^\_`abcdefghijklmnopqrstuvwxyz{|}~

**GUI\_Font8x13\_ASCII**

!"#\$%&'()\*+,-./0123456789:;<=>?@ABCDEFGH  
HIJKLMNOPQRSTUVWXYZ[\]^\_`abcdefghijklmnop  
qrstuvwxyz{|}~■

**GUI\_Font8x13\_1**

!"#\$%&'()\*+,-./0123456789:;<=>?@ABCDEFGH  
HIJKLMNOPQRSTUVWXYZ[\]^\_`abcdefghijklmnop  
qrstuvwxyz{|}~■ ¡¢£¥¦§¨ª«¬®¯°±²³´µ¶·  
¸¹º»¼½¾¿ÀÁÂÃÄÅÆÇÈÉÊËÌÍÎÏÐÑÒÓÔÕÖ×ØÙÚÛÜÝÞß  
àáâãäåæçèéêëìíîïðñòóôõö÷øùúûüýþÿ

**GUI\_Font8x15B\_ASCII**

!"#\$%&'()\*+,-./0123456789:;<=>?@ABCDEFGH  
HIJKLMNOPQRSTUVWXYZ[\]^\_`abcdefghijklmnop  
qrstuvwxyz{|}~■

**GUI\_Font8x15B\_1**

!"#\$%&'()\*+,-./0123456789:;<=>?@ABCDEFGH  
HIJKLMNOPQRSTUVWXYZ[\]^\_`abcdefghijklmnop  
qrstuvwxyz{|}~■ ¡¢£¥¦§¨ª«¬®¯°±²³´µ¶·  
¸¹º»¼½¾¿ÀÁÂÃÄÅÆÇÈÉÊËÌÍÎÏÐÑÒÓÔÕÖ×ØÙÚÛÜÝÞß  
àáâãäåæçèéêëìíîïðñòóôõö÷øùúûüýþÿ

**GUI\_Font8x16**

!"#\$%&'()\*+,-./0123456789:;<=>?@ABCDEFGH  
HIJKLMNOPQRSTUVWXYZ[\]^\_`abcdefghijklmnop  
qrstuvwxyz{|}~^ ↔↑↓↙ ↘ ¡¢£¥¦§¨ª«¬®¯°±  
²³´µ¶·¸¹º»¼½¾¿ÀÁÂÃÄÅÆÇÈÉÊËÌÍÎÏÐÑÒÓÔÕÖ×ØÙ  
ÚÛÜÝÞßàáâãäåæçèéêëìíîïðñòóôõö÷øùúûüýþÿ

**GUI\_Font8x17**

!"#\$%&'()\*+,-./0123456789:;<=>?@ABCDEFGH  
HIJKLMNOPQRSTUVWXYZ[\]^\_`abcdefghijklmnop  
qrstuvwxyz{|}~^ ↔↑↓↙ ↘ ¡¢£¥¦§¨ª«¬®¯°±  
²³´µ¶·¸¹º»¼½¾¿ÀÁÂÃÄÅÆÇÈÉÊËÌÍÎÏÐÑÒÓÔÕÖ×ØÙ  
ÚÛÜÝÞßàáâãäåæçèéêëìíîïðñòóôõö÷øùúûüýþÿ

**GUI\_Font8x18**

!"#\$%&'()\*+,-./0123456789:;<=>?@ABCDEFGH  
HIJKLMNOPQRSTUVWXYZ[\]^\_`abcdefghijklmnop  
qrstuvwxyz{|}~^ ↔↑↓↙ ↘ ¡¢£¥¦§¨ª«¬®¯°±  
²³´µ¶·¸¹º»¼½¾¿ÀÁÂÃÄÅÆÇÈÉÊËÌÍÎÏÐÑÒÓÔÕÖ×ØÙ  
ÚÛÜÝÞßàáâãäåæçèéêëìíîïðñòóôõö÷øùúûüýþÿ

GUI\_Font8x16x1x2

!"#\$%&'()\*+,-./0123456789:;<=>?@ABCDEFGH  
 IJKLMNOPQRSTUVWXYZ[\]^\_`abcdefghijklmnop  
 qrstuvwxyz{|}~`↔↑↓↕ ¡¢£¥¦§¨ª«¬®¯°±  
 ²³´µ¶·¸¹º»¼½¾¿ÀÁÂÃÄÅÆÇÈÉÊËÌÍÎÏÐÑÒÓÔÕÖ×ØÙ  
 ÚÛÜÝÞßàáâãäåæçèéêëìíîïðñòóôõö÷øùúûüýþÿ

GUI\_Font8x16x2x2

!"#\$%&'()\*+,-./0123  
 456789:;<=>?@ABCDEFGH  
 IJKLMNOPQRSTUVWXYZ[\]^\_`abcdefghijklmnop  
 qrstuvwxyz{|}~`↔↑↓↕ ¡¢£¥¦§¨ª«¬®¯°±  
 ²³´µ¶·¸¹º»¼½¾¿ÀÁÂÃÄÅÆÇÈÉÊËÌÍÎÏÐÑÒÓÔÕÖ×ØÙ  
 ÚÛÜÝÞßàáâãäåæçèéêëìíîïðñòóôõö÷øùúûüýþÿ

GUI\_Font8x16x3x3

!"#\$%&'()\*+,-./0123456789  
 :;<=>?@ABCDEFGHIJKLMNOPQRS  
 TUVWXYZ[\]^\_`  
 abcdefghijklmnopqrstuvwxyz  
 { } ~ ^ ← → ↑ ↓ √ ∫  
 € £ ¥ ¤ § ¨ © ª « ¬ ® ¯ ° ± ² ³ ´ µ ¶ · ¸ ¹ º »  
 ¼ ½ ¾ ¿ À Á Â Ã Ä Å Æ Ç È  
 É Ê Ë Ì Í Î Ï Ñ Ò Ó Ô Õ  
 Ö × Ø Ù Ú Û Ü Ý Þ ß à á â  
 ã ä å æ ç è é ê ë ì í î ï  
 ð ñ ò ó ô õ ö ÷ ø ù ú û ü  
 ý þ ÿ

GUI\_Font8x16\_ASCII

!"#\$%&'()\*+,-./0123456789  
 :;<=>?@ABCDEFGHIJKLMNOP  
 QRSTUVWXYZ[\]^\_`  
 abcdefghijklmnop  
 qrstuvwxyz{|}~

GUI\_Font8x16\_1

!"#\$%&'()\*+,-./0123456789  
 :;<=>?@ABCDEFGHIJKLMNOP  
 QRSTUVWXYZ[\]^\_`  
 abcdefghijklmnop  
 qrstuvwxyz{|}~ ¡ ¢ £ ¥ ¦ § ¨ © ª « ¬ ® ¯ ° ± ² ³ ´ µ ¶ · ¸ ¹ º »  
 ¼ ½ ¾ ¿ À Á Â Ã Ä Å Æ Ç È É Ê Ë Ì Í Î Ï Ñ Ò Ó Ô Õ Ö × Ø Ù Ú Û Ü Ý Þ ß  
 à á â ã ä å æ ç è é ê ë ì í î ï ð ñ ò ó ô õ ö ÷ ø ù ú û ü ý þ ÿ

5.6.10.7 Digit fonts (proportional)

5.6.10.7.1 Overview

The following screenshot gives an overview of all available proportional digit fonts:

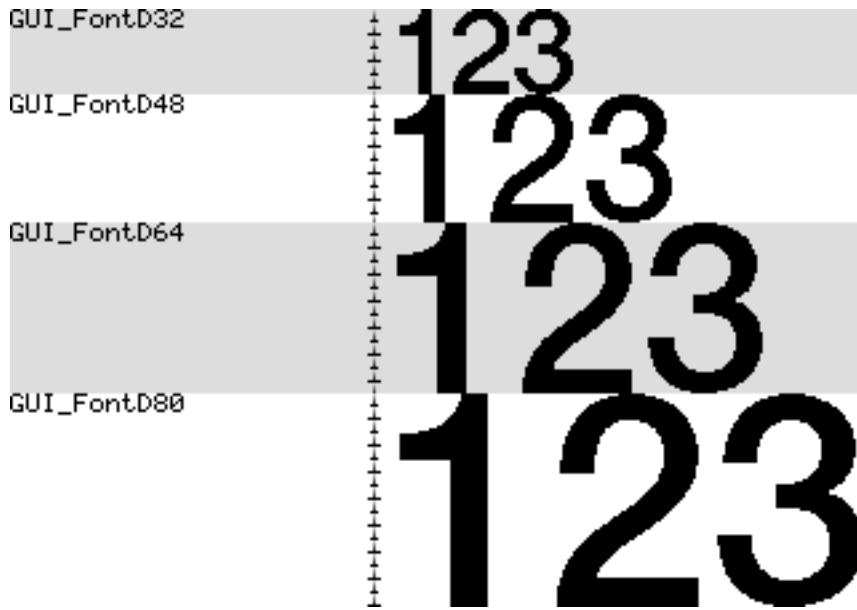

**5.6.10.7.2 Font details**

The following table shows the measurement, ROM size and used files of the fonts:

| Font name   | Measurement  | ROM size in bytes | Used files |
|-------------|--------------|-------------------|------------|
| GUI_FontD32 | F: 32, C: 31 | 1574              | FD32.c     |
| GUI_FontD48 | F: 48, C: 47 | 3512              | FD48.c     |
| GUI_FontD64 | F: 64, C: 63 | 5384              | FD64.c     |
| GUI_FontD80 | F: 80, C: 79 | 8840              | FD80.c     |

**5.6.10.7.3 Characters**

The following shows all characters of all proportional digit fonts:

**GUI\_FontD32**

+,-.012345678  
9:

**GUI\_FontD48**

+,-.01234  
56789:

GUI\_FontD64

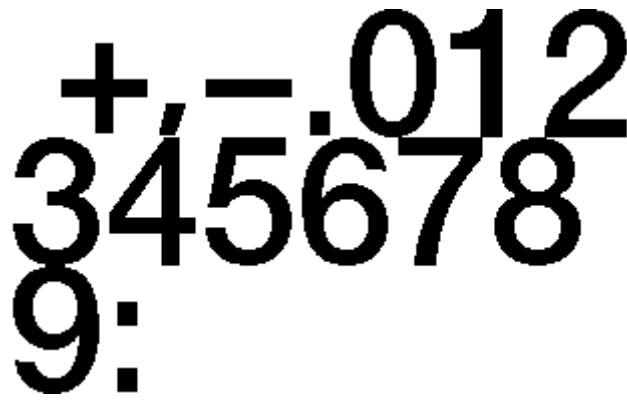

GUI\_FontD80

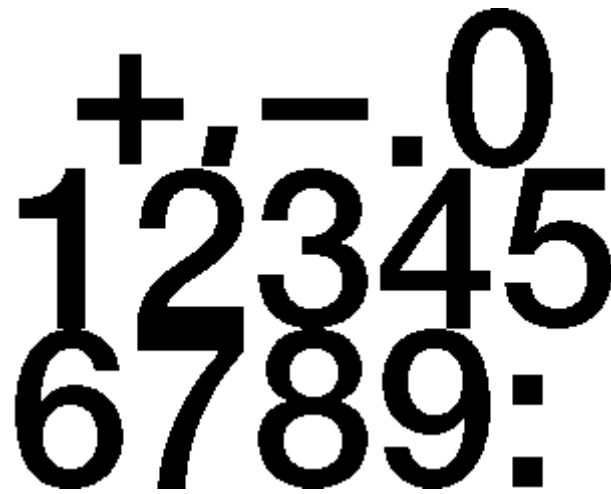

5.6.10.8 Digit fonts (monospaced)

5.6.10.8.1 Overview

The following screenshot gives an overview of all available monospaced digit fonts:

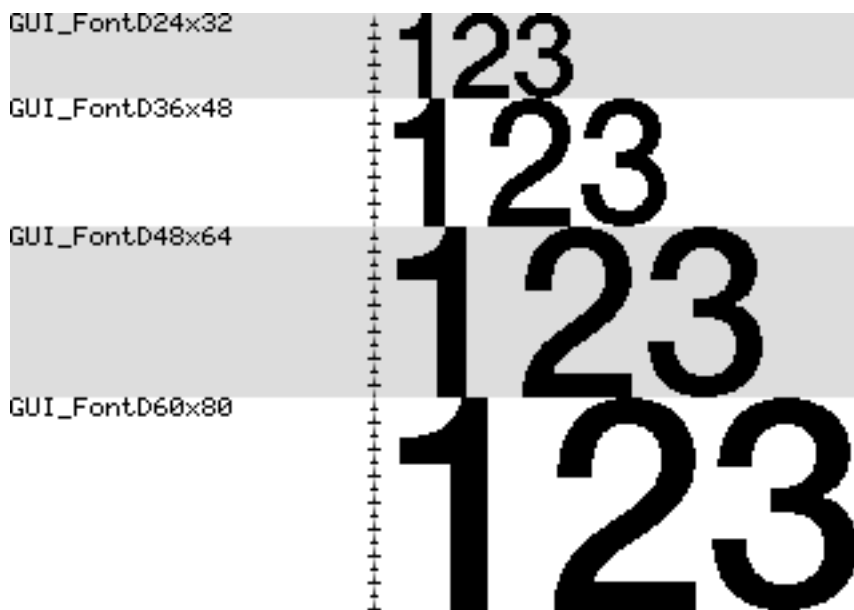

5.6.10.8.2 Font details

The following table shows the measurement, ROM size and used files of the fonts:

| Font name      | Measurement  | ROM size in bytes | Used files |
|----------------|--------------|-------------------|------------|
| GUI_FontD24x32 | F: 32, C: 31 | 1606              | FD24x32.c  |
| GUI_FontD36x48 | F: 48, C: 47 | 3800              | FD36x48.c  |
| GUI_FontD48x64 | F: 64, C: 63 | 5960              | FD48x64.c  |
| GUI_FontD60x80 | F: 80, C: 79 | 9800              | FD60x80.c  |

### 5.6.10.8.3 Characters

The following shows all characters of all monospaced digit fonts:

#### GUI\_FontD24x32

+ , - . 0 1 2 3 4 5 6 7  
8 9 :

#### GUI\_FontD36x48

+ , - . 0 1 2  
3 4 5 6 7 8 9 :

#### GUI\_FontD48x64

+ , - . 0  
1 2 3 4 5 6  
7 8 9 :

**GUI\_FontD60x80**

0 1 2 3 4  
5 6 7 8 9  
:



## 5.7 Animations

Animations can be achieved by playing GIF animations, movies or showing animated graphic objects. Whereas GIF animations and movies can be used only for playing a fixed sequence of pictures, the animation object of emWin is able to draw runtime generated scenes of one or multiple independent animated objects, which could be used to reflect dynamic application data. The following chapter explains how the animation object could be used to achieve user defined animations.

### 5.7.1 Introduction

Bringing up motion into an application could be done by several ways. If a fixed sequence of pictures does not work and one or more objects should change their properties like position, color, shape, size or whatever within a given period of time, emWin offers an animation object for exactly that purpose. It is able to animate multiple animation items during the timeline of an animation. Animation item means a custom defined routine which receives a position value from the animation object. That value is calculated in dependence of the current point in time. The calculation could be done by predefined or custom defined methods.

Each item has its own start and end time which determine if it is called or not during the execution.

## 5.7.2 Creating an animation object

Creating an animation object is done by passing the duration and the minimum time per 'slice' to the creation routine. Optionally a custom defined void pointer and a pointer to a 'slice callback' routine could be passed. The term 'slice' will be explained later. After the handle of an animation object is available one or more animation items could be added to the animation.

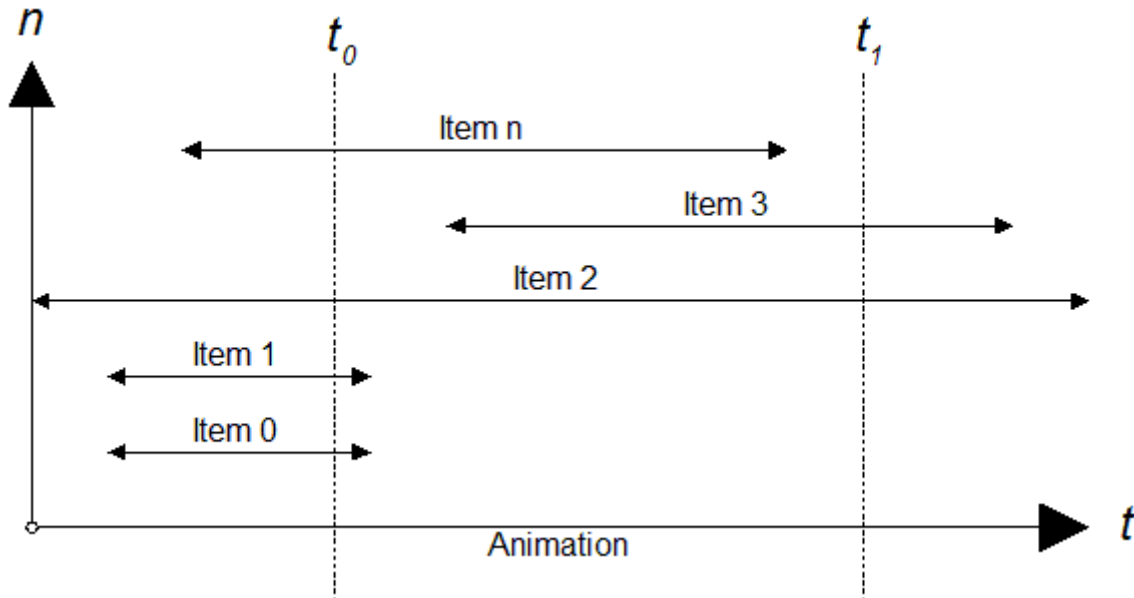

The diagram shows an animation with several items within the animation period where each item has its own start and end time. emWin does not limit the number of items. Start time and end time of each item have to be within the timeline of the animation.

### Example

```
//
// Creating an animation of 4 seconds and a min time/slice of 50ms
//
hAnim = GUI_ANIM_Create(4000, 50, NULL, NULL);
```

## 5.7.3 Adding items to an animation

An animation item is a routine which receives information from the animation object during the period of execution. When adding an item its start time, end time, 'method of position calculation' and animation routine to be called should be passed. Further an optional void pointer could be used which is passed to the animation routine during the animation is executed.

### Example

```
static void _AnimDrawSomething(GUI_ANIM_INFO * pInfo, void * pVoid) {
    ...
}
void Application(void){
    ...
    GUI_ANIM_AddItem(hAnim, 500, 2500, ANIM_LINEAR, pVoid, _AnimDrawSomething);
    ...
}
```

### 5.7.4 Position calculation

Each item has its own start and end time within the timeline of the animation. If the current point of time is within the period of an item, the animation object calculates a position value. The following table shows the available methods for calculating the position value:

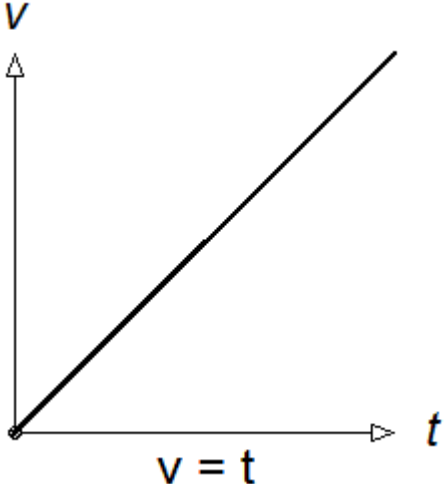
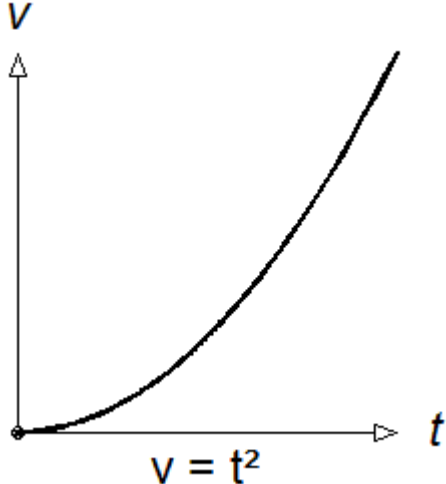
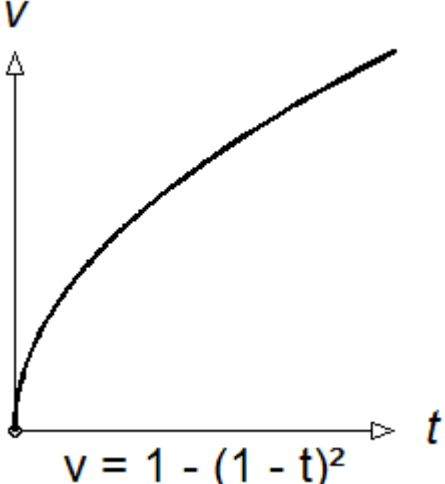
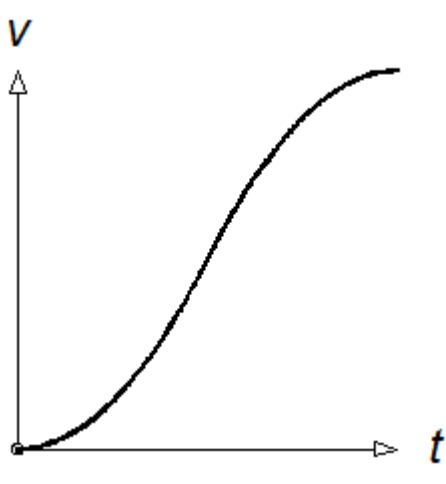
| ANIM_LINEAR   | ANIM_ACCEL   |
|---|--|
|  <p style="text-align: center;"><math>v = t</math></p>               |  <p style="text-align: center;"><math>v = t^2</math></p> |
| ANIM_DECEL  | ANIM_ACCELDECEL  |
|  <p style="text-align: center;"><math>v = 1 - (1 - t)^2</math></p> |    |

The value passed to the application is between 0 and GUI\_ANIM\_RANGE. If for example ANIM\_ACCEL is used and the animation item is currently exactly in the middle the value passed to the application is  $0.5 * 0.5 * \text{GUI\_ANIM\_RANGE}$ .

#### GUI\_ANIM\_RANGE

That value is defined by emWin as follows:

| Type | Macro          | Default | Description                               |
|------|----------------|---------|---|
| v    | GUI_ANIM_RANGE | 32767   | Define the default range of an animation. |

The value could be changed on demand.

### 5.7.4.1 Custom defined position calculation

If the above predefined methods do not meet the requirements a custom defined routine could be used. The below sample shows how that works. The routine is called by the animation object each time a single position value is required. The routine gets start time, end time and current time of the animation item. Its job is to calculate a value in dependence of the given parameters. The predefined methods of emWin generate values between 0 and GUI\_ANIM\_RANGE. If a custom defined routine is used the range could be different.

#### Example

```
I32 _CalcPosition(GUI_TIMER_TIME ts, GUI_TIMER_TIME te, GUI_TIMER_TIME tNow) {  
    ...  
}  
void Application(void) {  
    ...  
    GUI_ANIM_AddItem(hAnim, ..., ..., _CalcPosition, ..., ...);  
    ...  
}
```

## 5.7.5 Executing an animation

Simply call `GUI_ANIM_StartEx()`. That function offers the possibility to run an animation a determined number of times or within an endless loop. `GUI_ANIM_Stop()` could be used to stop an animation which is running. Alternatively `GUI_ANIM_Exec()` could be called periodically to keep an animation alive, but most recommended is using automatic mode.

Each time emWin executes an animation (auto mode or with `GUI_ANIM_Exec()`) it checks which items of the given animation are within the current point of time. That collection of items represents one slice of animation items which are called at the given point of time. The animation diagram at the beginning for example shows the points of time  $t_0$  and  $t_1$ . The  $t_0$  slice consists of items 0, 1, 2 and n and the  $t_1$  slice of item 2 and 3. The following example shows how an animation could be executed:

### Example

```
void Application(void) {
    ...
    GUI_ANIM_StartEx(hAnim, -1, NULL); // Start animation in endless loop
    ...
    while (1) {
        GUI_Delay(1);
    }
}
```

### 5.7.5.1 Using a slice callback function

Before calling the first item of an animation slice and after calling the last item an optional callback function could be called. A slice callback function could be used for example to avoid flickering. Before drawing the first item the application could switch to the back buffer or lock the cache and after drawing the last item the back buffer could be made visible or the cache could be unlocked. To use a slice callback function a pointer to that function should be passed to the creation routine.

### Example

```
static void _cbSliceInfo(int State, void * pVoid) {
    switch (State) {
        case GUI_ANIM_START:
            GUI_MULTIBUF_Begin();
            break;
        case GUI_ANIM_END:
            GUI_MULTIBUF_End();
            break;
    }
}

void Application(void) {
    ...
    hAnim = GUI_ANIM_Create(..., ..., pVoid, _cbSliceInfo);
}
```

### 5.7.5.2 Animation item

An animation item is simply a routine which is executed by the animation object. It is called by passing a pointer to a `GUI_ANIM_INFO` structure and the application defined void pointer passed to `GUI_ANIM_AddItem()`.

### Prototype

```
static void _AnimDrawRect(GUI_ANIM_INFO * pInfo,
                        void * pVoid);
```

### 5.7.5.3 Using a delete callback function

A delete callback is a routine that will be called when an animation has ended. This can be useful e.g. when a window handle should be deleted after an animation has finished. A delete callback is also called, when `GUI_ANIM_Delete()` is called for an animation.

#### Prototype

```
static void _OnDelete(void * pVoid);
```

#### Usage

A delete callback can be set for an animation by passing the function pointer to `GUI_ANIM_StartEx()`. The void pointer passed to `GUI_ANIM_Create()` as third parameter will also be passed to the delete callback of that animation.

#### Example

```
static void _OnDelete(void * pVoid) {
    ANIM_DATA * pData;
    pData = (ANIM_DATA *)pVoid;
    ...
}
...
ANIM_DATA Data;
...
hAnim = GUI_ANIM_Create(ANIM_PERIOD, 50, &Data, NULL);
...
GUI_ANIM_StartEx(hAnim, 1, _OnDelete);
```

## 5.7.6 Animations API

The following table lists the animation related API functions.

### Functions

| Routine                              | Description  |
|--------------------------------------|--|
| <code>GUI_ANIM_AddItem()</code>      | Adds an item to the given animation.   |
| <code>GUI_ANIM_AddItemById()</code>  | Adds an item to the given animation.   |
| <code>GUI_ANIM_Create()</code>       | Creates an animation object.   |
| <code>GUI_ANIM_CreateWithId()</code> | Creates an animation object.   |
| <code>GUI_ANIM_Delete()</code>       | Deletes an animation object and all of its data.   |
| <code>GUI_ANIM_DeleteAll()</code>    | Deletes all animations.  |
| <code>GUI_ANIM_DeleteById()</code>   | Deletes an animation object and all of its data.   |
| <code>GUI_ANIM_Exec()</code>         | Should be used to keep the given animation alive.  |
| <code>GUI_ANIM_Get()</code>          | Returns the handle of the given animation.   |
| <code>GUI_ANIM_GetData()</code>      | Returns the optional void pointer passed to the animation with <code>GUI_ANIM_Create()</code> .      |
| <code>GUI_ANIM_GetFirst()</code>     | Returns the handle of the first animation to be executed automatically.                              |
| <code>GUI_ANIM_GetItemData()</code>  | Returns the optional void pointer passed to an animation item with <code>GUI_ANIM_AddItem()</code> . |
| <code>GUI_ANIM_GetNext()</code>      | Returns the handle of the next animation to be executed after the given animation.                   |
| <code>GUI_ANIM_GetNumItems()</code>  | Returns the number of items in an animation.   |
| <code>GUI_ANIM_IsRunning()</code>    | Returns if an animation is running.  |
| <code>GUI_ANIM_Start()</code>        | Sets the start time of the given animation.  |
| <code>GUI_ANIM_StartEx()</code>      | Starts the given animation automatically.  |
| <code>GUI_ANIM_StartExId()</code>    | Sets the start time of the given animation and processes the animation automatically.                |
| <code>GUI_ANIM_Stop()</code>         | Stops the animation correspondig to the given handle.  |
| <code>GUI_ANIM_StopById()</code>     | Stops the animation correspondig to the given handle.  |

### Data structures

| Structure                  | Description   |
|----------------------------|---|
| <code>GUI_ANIM_INFO</code> | Contains information about the current state of an animation. |

### Defines

| Group of defines              | Description                               |
|-------------------------------|---|
| <code>Animation states</code> | List of possible states for an animation. |

## 5.7.6.1 Functions

### 5.7.6.1.1 GUI\_ANIM\_AddItem()

#### Description

Adds an item to the given animation.

#### Prototype

```
int GUI_ANIM_AddItem(GUI_ANIM_HANDLE      hAnim,
                    GUI_TIMER_TIME       ts,
                    GUI_TIMER_TIME       te,
                    GUI_ANIM_GETPOS_FUNC pfGetPos,
                    void                  * pVoid,
                    GUI_ANIMATION_FUNC   * pfAnim);
```

#### Parameters

| Parameter             | Description  |
|-----------------------|--|
| <code>hAnim</code>    | Handle of animation object to be used.                                       |
| <code>ts</code>       | Relative start time in ms.   |
| <code>te</code>       | Relative end time in ms. Needs to be > <code>ts</code> .                     |
| <code>pfGetPos</code> | Pointer to a routine for calculating the position value.                     |
| <code>pVoid</code>    | Optional void pointer passed to the animation function during the execution. |
| <code>pfAnim</code>   | Pointer to the animation function (item) to be executed by the object.       |

#### Return value

0        on success  
1        on error.

#### Additional information

Start and end time are relative to the time value set when calling `GUI_ANIM_Start()`.



### 5.7.6.1.2 GUI\_ANIM\_AddItemById()

#### Description

Adds an item to the given animation.

#### Prototype

```
int GUI_ANIM_AddItemById(I16          Id,
                        GUI_TIMER_TIME ts,
                        GUI_TIMER_TIME te,
                        GUI_ANIM_GETPOS_FUNC pfGetPos,
                        void          * pVoid,
                        GUI_ANIMATION_FUNC * pfAnim);
```

#### Parameters

| Parameter             | Description  |
|-----------------------|--|
| <code>Id</code>       | <code>Id</code> of animation object to be used.                              |
| <code>ts</code>       | Relative start time in ms.   |
| <code>te</code>       | Relative end time in ms. Needs to be > <code>ts</code> .                     |
| <code>pfGetPos</code> | Pointer to a routine for calculating the position value.                     |
| <code>pVoid</code>    | Optional void pointer passed to the animation function during the execution. |
| <code>pfAnim</code>   | Pointer to the animation function (item) to be executed by the object.       |

#### Return value

0        on success  
1        on error.

#### Additional information

Start and end time are relative to the time value set when calling `GUI_ANIM_Start()`.

### 5.7.6.1.3 GUI\_ANIM\_Create()

#### Description

Creates an animation object.

#### Prototype

```
GUI_ANIM_HANDLE GUI_ANIM_Create(GUI_TIMER_TIME   Period,
                                unsigned         MinTimePerSlice,
                                void             * pVoid,
                                void             (* pfSlice)(int , void * ));
```

#### Parameters

| Parameter                       | Description   |
|---------------------------------|---|
| <a href="#">Period</a>          | Duration in ms of the whole animation. Maximum value is 0x20000.                        |
| <a href="#">MinTimePerSlice</a> | Minimum time of one animation slice in ms.  |
| <a href="#">pVoid</a>           | Optional void pointer passed to the slice callback function and/or the delete function. |
| <a href="#">pfSlice</a>         | Optional slice callback function.   |

#### Return value

Handle of the animation object or 0 if no memory is available.

#### Additional information

The value [MinTimePerSlice](#) determines the frame rate when executing the animation with [GUI\\_ANIM\\_Exec\(\)](#). The given time determines the minimum period between the execution of 2 slices of animation items.

### 5.7.6.1.4 GUI\_ANIM\_CreateWithId()

#### Description

Creates an animation object.

#### Prototype

```
GUI_ANIM_HANDLE GUI_ANIM_CreateWithId(GUI_TIMER_TIME   Period,
                                       unsigned         MinTimePerSlice,
                                       void             * pVoid,
                                       void             (* pfSlice)(int , void * ),
                                       I16              Id);
```

#### Parameters

| Parameter                       | Description   |
|---------------------------------|---|
| <a href="#">Period</a>          | Duration in ms of the whole animation. Maximum value is 0x20000.                        |
| <a href="#">MinTimePerSlice</a> | Minimum time of one animation slice in ms.  |
| <a href="#">pVoid</a>           | Optional void pointer passed to the slice callback function and/or the delete function. |
| <a href="#">pfSlice</a>         | Optional slice callback function.   |
| <a href="#">Id</a>              | <a href="#">Id</a> of the animation.  |

#### Return value

Handle of the animation object or 0 if no memory is available.

#### Additional information

The value [MinTimePerSlice](#) determines the frame rate when executing the animation with [GUI\\_ANIM\\_Exec\(\)](#). The given time determines the minimum period between the execution of 2 slices of animation items.

### 5.7.6.1.5 GUI\_ANIM\_Delete()

#### Description

Deletes an animation object and all of its data.

#### Prototype

```
void GUI_ANIM_Delete(GUI_ANIM_HANDLE hAnim);
```

#### Parameters

| Parameter          | Description                            |
|--------------------|--|
| <code>hAnim</code> | Handle of animation object to be used. |

### 5.7.6.1.6 GUI\_ANIM\_DeleteAll()

#### Description

Deletes all animations. Also calls the deletion function for each animation if it is set.

#### Prototype

```
void GUI_ANIM_DeleteAll(void);
```

### 5.7.6.1.7 GUI\_ANIM\_DeleteById()

#### Description

Deletes an animation object and all of its data.

#### Prototype

```
int GUI_ANIM_DeleteById(I16 Id);
```

#### Parameters

| Parameter          | Description  |
|--------------------|--|
| <a href="#">Id</a> | <a href="#">Id</a> of animation object to be used. |

### 5.7.6.1.8 GUI\_ANIM\_Exec()

#### Description

Should be used to keep the given animation alive. The function needs to be called periodically.

#### Prototype

```
int GUI_ANIM_Exec(GUI_ANIM_HANDLE hAnim);
```

#### Parameters

| Parameter          | Description                            |
|--------------------|--|
| <code>hAnim</code> | Handle of animation object to be used. |

#### Return value

- 0 if the given animation is within its timeline.
- 1 if the animation period is expired.

#### Additional information

Within a typical execution loop the application should give other tasks a chance to do something. That can be done by simply calling `GUI_Delay()`.

#### Example

```
while (GUI_ANIM_Exec(hAnim) == 0) {  
    GUI_X_Delay(5); // Idle time for other tasks  
}
```

### 5.7.6.1.9 GUI\_ANIM\_Get()

#### Description

Returns the handle of the given animation.

#### Prototype

```
GUI_ANIM_HANDLE GUI_ANIM_Get ( I16 Id );
```

#### Parameters

| Parameter          | Description  |
|--------------------|--|
| <a href="#">Id</a> | <a href="#">Id</a> of animation object to be returned. |

#### Return value

Handle of animation object, 0 on error.



### 5.7.6.1.10 GUI\_ANIM\_GetData()

#### Description

Returns the optional void pointer passed to the animation with `GUI_ANIM_Create()`.

#### Prototype

```
void *GUI_ANIM_GetData(GUI_ANIM_HANDLE hAnim);
```

#### Parameters

| Parameter          | Description       |
|--------------------|-------------------|
| <code>hAnim</code> | Animation handle. |

#### Return value

Void pointer passed to the animation.

### 5.7.6.1.11 GUI\_ANIM\_GetFirst()

#### Description

Returns the handle of the first animation to be executed automatically.

#### Prototype

```
GUI_ANIM_HANDLE GUI_ANIM_GetFirst(void);
```

### 5.7.6.1.12 GUI\_ANIM\_GetItemData()

#### Description

Returns the optional void pointer passed to an animation item with `GUI_ANIM_AddItem()`.

#### Prototype

```
void *GUI_ANIM_GetItemData(GUI_ANIM_HANDLE hAnim,  
                           unsigned Index);
```

#### Parameters

| Parameter          | Description                           |
|--------------------|---------------------------------------|
| <code>hAnim</code> | Animation handle.                     |
| <code>Index</code> | <code>Index</code> of animation item. |

#### Return value

Void pointer passed to the animation item.

### 5.7.6.1.13 GUI\_ANIM\_GetNext()

#### Description

Returns the handle of the next animation to be executed after the given animation.

#### Prototype

```
GUI_ANIM_HANDLE GUI_ANIM_GetNext(GUI_ANIM_HANDLE hAnim);
```

#### Parameters

| Parameter             | Description       |
|-----------------------|-------------------|
| <a href="#">hAnim</a> | Animation handle. |

#### Return value

Handle of next animation to be executed.

#### 5.7.6.1.14 GUI\_ANIM\_GetNumItems()

##### Description

Returns the number of items in an animation.

##### Prototype

```
int GUI_ANIM_GetNumItems(GUI_ANIM_HANDLE hAnim);
```

##### Parameters

| Parameter          | Description       |
|--------------------|-------------------|
| <code>hAnim</code> | Animation handle. |

##### Return value

Number of items present in the given animation.

### 5.7.6.1.15 GUI\_ANIM\_IsRunning()

#### Description

Returns if an animation is running.

#### Prototype

```
int GUI_ANIM_IsRunning(GUI_ANIM_HANDLE hAnim);
```

#### Parameters

| Parameter             | Description       |
|-----------------------|-------------------|
| <a href="#">hAnim</a> | Animation handle. |

#### Return value

- 0 if the animation is not running.
- 1 if the animation is running.

### 5.7.6.1.16 GUI\_ANIM\_Start()

#### Description

Sets the start time of the given animation.

#### Prototype

```
void GUI_ANIM_Start(GUI_ANIM_HANDLE hAnim);
```

#### Parameters

| Parameter          | Description                            |
|--------------------|--|
| <code>hAnim</code> | Handle of animation object to be used. |

#### Additional information

The function does nothing but setting the current time as start time. From that moment `GUI_ANIM_Exec()` should return 0 for the given animation period.

### 5.7.6.1.17 GUI\_ANIM\_StartEx()

#### Description

Sets the start time of the given animation and processes the animation automatically.

#### Prototype

```
void GUI_ANIM_StartEx(GUI_ANIM_HANDLE hAnim,
                    int NumLoops,
                    void (*pfOnDelete)(void * pVoid ));
```

#### Parameters

| Parameter               | Description   |
|-------------------------|---|
| <code>hAnim</code>      | Handle of animation object to be used.  |
| <code>NumLoops</code>   | Number of loops the animation should be executed.<br>-1 causes the animation to run endlessly until it is stopped with <code>GUI_ANIM_Stop()</code> . |
| <code>pfOnDelete</code> | Function pointer to a function which should be executed on deletion of the animation.   |

#### Additional information

This function should be used instead of `GUI_ANIM_Start()` since it is no longer necessary to call `GUI_ANIM_Start()` in combination `GUI_ANIM_Exec()` and handle the animation process on your own. `GUI_ANIM_StartEx()` handles the process automatically.



### 5.7.6.1.18 GUI\_ANIM\_StartExId()

#### Description

Sets the start time of the given animation and processes the animation automatically.

#### Prototype

```
int GUI_ANIM_StartExId(I16 Id,
                      int NumLoops,
                      void ( *pfOnDelete)(void * pVoid ));
```

#### Parameters

| Parameter               | Description   |
|-------------------------|---|
| <code>Id</code>         | <code>Id</code> of animation object to be used.   |
| <code>NumLoops</code>   | Number of loops the animation should be executed.<br>-1 causes the animation to run endlessly until it is stopped with <code>GUI_ANIM_Stop()</code> . |
| <code>pfOnDelete</code> | Function pointer to a function which should be executed on deletion of the animation.   |

#### Additional information

This function should be used instead of `GUI_ANIM_Start()` since it is no longer necessary to call `GUI_ANIM_Start()` in combination `GUI_ANIM_Exec()` and handle the animation process on your own. `GUI_ANIM_StartEx()` handles the process automatically.

### 5.7.6.1.19 GUI\_ANIM\_Stop()

#### Description

Stops the animation correspondig to the given handle.

#### Prototype

```
void GUI_ANIM_Stop(GUI_ANIM_HANDLE hAnim);
```

#### Parameters

| Parameter          | Description                            |
|--------------------|--|
| <code>hAnim</code> | Handle of animation object to be used. |

### 5.7.6.1.20 GUI\_ANIM\_StopById()

#### Description

Stops the animation corresponding to the given handle.

#### Prototype

```
int GUI_ANIM_StopById(I16 Id);
```

#### Parameters

| Parameter       | Description                                     |
|-----------------|---|
| <code>Id</code> | <code>Id</code> of animation object to be used. |

#### Return value

0 on success, 1 on error.

## 5.7.6.2 Data structures

### 5.7.6.2.1 GUI\_ANIM\_INFO

#### Description

Contains information about the current state of an animation.

#### Type definition

```
typedef struct {
    int          Pos;
    int          State;
    GUI_ANIM_HANDLE hAnim;
    GUI_TIMER_TIME Period;
    unsigned     Index;
} GUI_ANIM_INFO;
```

#### Structure members

| Member                 | Description   |
|------------------------|---|
| <a href="#">Pos</a>    | Position value calculated by the selected position calculation routine.                           |
| <a href="#">State</a>  | <a href="#">State</a> of the animation. See <i>Animation states</i> on page 641 for valid values. |
| <a href="#">hAnim</a>  | Handle of the animation object.   |
| <a href="#">Period</a> | <a href="#">Period</a> of the animation object.   |
| <a href="#">Index</a>  | Item index  |

## 5.7.6.3 Defines

### 5.7.6.3.1 Animation states

#### Description

Describes the current state of an animation. Sent with the `State` member of the `GUI_ANIM_INFO` structure to an animation callback.

#### Definition

```
#define GUI_ANIM_START      0
#define GUI_ANIM_RUNNING   1
#define GUI_ANIM_END       2
```

#### Symbols

| Definition                    | Description   |
|-------------------------------|---|
| <code>GUI_ANIM_START</code>   | First execution.  |
| <code>GUI_ANIM_RUNNING</code> | Passed to all items which are not the first and not the last. |
| <code>GUI_ANIM_END</code>     | Last execution.   |

## 5.8 Movies

With the movie file support of emWin it is possible to show movies. The movie file can be in two different formats. Besides our own movie format (EMF) it is also possible to display AVI files.

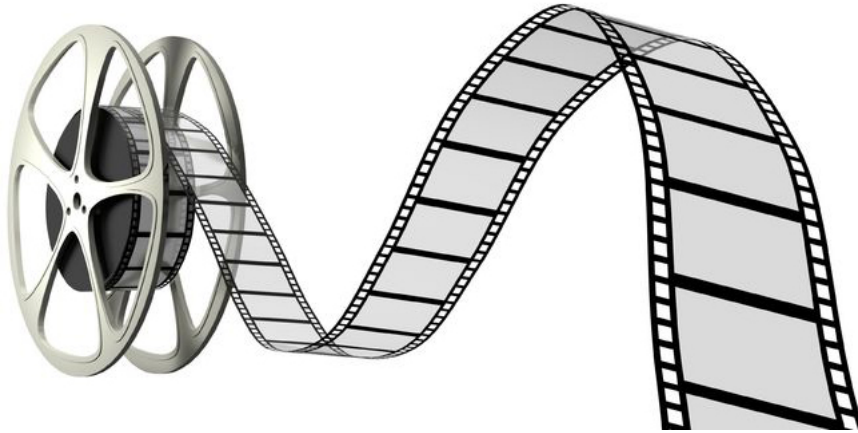

### 5.8.1 Introduction

#### EMF format

One way to play movies with the emWin API functions is to create files of the emWin specific **(E)mWin (M)ovie (F)ile** format. These EMF files are containers for single JPEG files. To be able to create such movie files each emWin-shipment contains the tool JPEG2Movie in the `\Tools` folder. This converter requires a folder containing JPEG images for each frame to be used.

Usually there are already existing movie files which should be shown with emWin. But the format of these files do not match the EMF file format. Because of that at first a tool is required which is able to create a folder with single JPEG files for each frame of the movie.

All that sounds quite complicated but can be done by a single drag-and-drop operation to one of our helper files. The following will explain in detail what needs to be done to be able to do that.

#### AVI format

Another way to show movies is to use the AVI format (Audio Video Interleave) which was introduced Microsoft. To be able to show AVI files these files must reside in a specific format. Please refer to *Requirements* on page 73.

The easiest way to create an AVI file which fits the requirements is to use the batch files which come with every emWin shipment. Please refer to *Creating an AVI file* on page 646 for more information.

## 5.8.2 Requirements

In opposite to movie file rendering using different frame methods the EMF file format contains complete JPEG files for each frame. The advantage of this format is that not more than one frame is required in memory.

### RAM requirement

For the rendering process of an EMF file it is required to have enough dynamic RAM as required for rendering a single JPEG file plus the file size of a single JPEG file. The RAM requirement for rendering a JPEG file can be found in the chapter *JPEG file support* on page 439.

```
Requirement = JPEG requirement + File size of a single JPEG file
```

Please note that `File size` does not mean the whole movie file. It means the size of the biggest JPEG file of the movie only.

### ROM requirement

Apart from the ROM requirement of the movie file itself approx. 22 KByte of additional ROM for the binary code for rendering JPEG based movie files are required.

### Performance

To achieve a fluently rendering of the movie a frame rate of 25 frames/seconds is recommended.

### AVI files

There are two requirements to be able to display AVI files with emWin.

The codec to be used in AVI file has to be MJPEG and the AVI file has to contain an index list called `idx1` list.

The AVI files can also contain sound files, but these are not handled by emWin, yet.

## 5.8.3 Creating JPEG files with FFmpeg.exe

As mentioned above at first a tool is required which is able to convert files of any movie file format into a folder of single JPEG files for each frame. Currently a plenty of movie file formats exist. emWin does not support all these movie file formats directly.

We recommend the open source tool FFmpeg which is available under [ffmpeg.org](http://ffmpeg.org). It is free software licensed under the LGPL or GPL. It is able to convert files of nearly any movie file source format into any desired destination format, also into single JPEG files.

Because the tool is licensed under the LGPL we do not ship this tool directly. It can be loaded from [ffmpeg.org](http://ffmpeg.org). Version N-49757-g969039e or newer should be used.

## 5.8.4 Creating an EMF file

To make the conversion process as easy as possible there are batch files available in the folder `Sample\MakeMovie\EMF`. These files are:

| File   | Description   |
|--|---|
| <code>Prep.bat</code>                          | Sets some defaults to be used. Needs to be adapted as explained in the following. |
| <code>MakeMovie.bat</code>                     | Main conversion file. Does not to be adapted normally.                            |
| <code>&lt;X_SIZE&gt;x&lt;Y_SIZE&gt;.bat</code> | Some helper files for different resolutions. Detailed description follows.        |

### Note

Please note that all these files need to be located in the same folder. Otherwise they will not work correctly.

### Prep.bat

The `Prep.bat` is required to prepare the environment for the actual process. Calling it directly will not have any effect. It is called by the `MakeMovie.bat`. To be able to use the batch files it is required to adapt this file at first. This file sets variables used by the file `MakeMovie.bat`. The following table shows these variables:

| Variable                         | Description   |
|----------------------------------|---|
| <code>%OUTPUT%</code>            | Destination folder for the JPEG files. Will be cleared automatically when starting the conversion with <code>MakeMovie.bat</code> .   |
| <code>%FFMPEG%</code>            | Access variable for the FFmpeg tool. Should contain the complete path required to call <code>FFmpeg.exe</code> .  |
| <code>%JPEG2MOVIE%</code>        | Access variable for the JPEG2MOVIE tool. Should contain the complete path required to call <code>JPEG2Movie.exe</code> .  |
| <code>%DEFAULT_SIZE%</code>      | Default movie resolution to be used. Can be ignored if one of the <code>&lt;X-SIZE&gt;x&lt;Y-SIZE&gt;.bat</code> files are used.  |
| <code>%DEFAULT_QUALITY%</code>   | Default quality to be used by <code>FFmpeg.exe</code> for creating the JPEG files. The less the number the better the quality. The value 1 indicates that a very good quality should be achieved. The value 31 indicates the worst quality. Details can be found in the FFmpeg documentation. |
| <code>%DEFAULT_FRAMERATE%</code> | Frame rate in frames/second to be used by FFmpeg. It defines the number of JPEG files to be generated by <code>FFmpeg.exe</code> for each second of the movie. Details can be found in the FFmpeg documentation.  |

### MakeMovie.bat

This is the main batch file used for the conversion process. Normally it is not required to be change this file, but it is required to adapt `Prep.bat` first. It could be called with the following parameters:

| Parameter                  | Description  |
|----------------------------|--|
| <code>%1</code>            | Movie file to be converted.  |
| <code>%2 (optional)</code> | Size to be used. If not given <code>%DEFAULT_SIZE%</code> of <code>Prep.bat</code> is used.            |
| <code>%3 (optional)</code> | Quality to be used. If not given <code>%DEFAULT_QUALITY%</code> of <code>Prep.bat</code> is used.      |
| <code>%4 (optional)</code> | Frame rate to be used. If not given <code>%DEFAULT_FRAMERATE%</code> of <code>Prep.bat</code> is used. |



Since the `FFmpeg` output can differ strongly from the output of previous actions, the `Make-Movie.bat` deletes all output files in the first place. The output folder is defined by in the environmental variable `%OUTPUT%` in `Prep.bat`. After that it uses `FFmpeg.exe` to create the required JPEG files for each frame. Afterwards it calls `JPEG2Movie` to create a single EMF file which can be used by `emWin` directly. After the conversion operation the result can be found in the conversion folder under `FFmpeg.emf`. It also creates a copy of that file into the source file folder. It will have the same name as the source file with a size-postfix and `.emf` extension.

If for example the source file is: `C:\Temp\Movie.mp4` and the size to be used is `480x272` the folder `C:\Temp\` will contain the file `Movie_480x272.emf` after the conversion.

### **<X\_SIZE>x<Y\_SIZE>.bat**

These files are small but useful helpers if several movie resolutions are required. The file-names of the batch files itself are used as parameter `-s` for `FFmpeg.exe`. You can simply drag-and-drop the file to be converted to one of these helper files. After that an `.emf` file with the corresponding size-postfix can be found in the source file folder.

## 5.8.5 Creating an AVI file

Creating an AVI file which can be played with emWin is as simple as it is for EMF files. The folder `Sample\MakeMovie\AVI` contains almost the same batch files as the EMF folder except that it calls `ffmpeg.exe` with different parameters. Refer to *Creating an EMF file* on page 644 to get more information about the used parameters.

## 5.8.6 Modifying the conversion result

The process of conversion explained above describes how to convert a given movie automatically. But sometimes it could be required to remove or edit JPEGs after generating the images by `FFmpeg` and before creating the EMF file with `JPEG2Movie`. The most simple method for doing that is first creating a complete movie automatically as described above. After that the conversion folder defined by the `%FOLDER%` variable in `Prep.bat` contains all images. Now please feel free to remove, change or add images to the folder. After that `JPEG2Movie` can be used to convert the new compilation of files to an EMF file.

## 5.8.7 Using JPEG2Movie

If there is an already existing compilation of JPEG files to be used the tool `JPEG2Movie` can be used directly. It is available in the `\Tool` folder of each shipment:

1. Start `JPEG2Movie.exe`.
2. Select one of the existing JPEG files from the source folder with 'Select file'.
3. Define the frame duration to be used (default is 40ms).
4. Click the 'Convert' button for creating the EMF file.

After that the folder of the selected file should contain an EMF file. Please note that all JPEGs should have exactly the same resolution.

### Screenshot of the tool

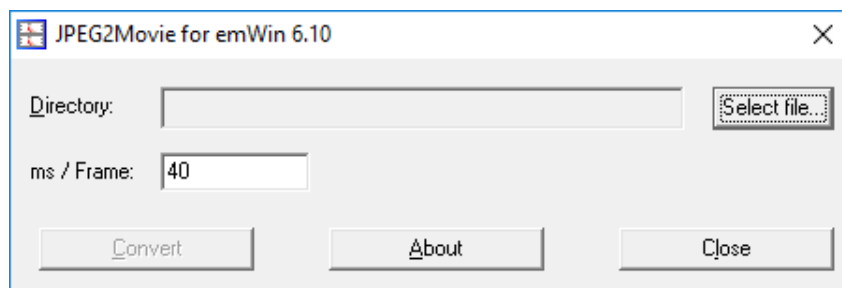

## 5.8.8 Bitmap-EMF files

### About Bitmap-EMFs

Bitmap-based emWin movie files (EMF) have been added to emWin as an alternative format for GIF animations and standard EMFs. The format is composed of bitmap frames which are saved in emWin's DTA format. Since this format makes use of uncompressed bitmaps, the time required for drawing frames is greatly reduced. The format outperforms JPEGs and GIFs, especially on hardware targets, since no encoding of the frames is required.

The format also allows the use of any emWin bitmap format available (except RLE compressed formats), as well as color formats.

#### Note

The bitmap-based EMF format is an **uncompressed** format, therefore the files are intended to be stored on external memory due to the large file size.

### Generating Bitmap-EMFs

Bitmap-EMFs can be generated from GIF animations using the Bitmap Converter. The corresponding chapter provides information about how the files can be converted, see *Converting GIFs into Bitmap-EMFs* on page 2824.

### Memory requirement

As hinted above, the Bitmap-EMF format is quite memory intensive, since it is an uncompressed format aimed at performance. The memory requirement for an EMF file is dependent on the bit depth and bitmap dimensions.

To calculate the memory requirement, the following formula may be used:

```
NumBytesPal      = (NumColors * 4);  
NumBytesPerFrame = (((xSize * Bpp) + 7) / 8) * ySize + NumBytesPal + 16;  
NumBytesEMF     = (NumFrames * NumBytesPerFrame) + (NumFrames * 8) + 24;
```

### Playing a movie

Bitmap-EMFs can be created and run the same way as standard emWin movies using `GUI_MOVIE_CreateEx()` and `GUI_MOVIE_Show()`.

### 5.8.8.1 Sample program to run EMF from external memory

The sample program below runs EMF files from external memory under both the Windows simulation and on a hardware target using emFile.

```

#include "DIALOG.h"
#include <stdio.h>
#ifdef WIN32
    #include <windows.h>
#else
    #include "FS.h"
#endif

/*****
 *
 *      Defines
 *
 *****/
#ifdef WIN32
    #define FILE_PATH "c:\\Temp\\Anim.emf"
#else
    #define FILE_PATH "Anim.emf"
#endif

/*****
 *
 *      Static data
 *
 *****/

/*****
 *
 *      Static code
 *
 *****/
/*****
 *
 *      _GetData
 *
 * Function description
 * Reading data directly from file system
 */
int _GetData(void * p, const U8 ** ppData, unsigned NumBytes, U32 Off) {
    U32 NumBytesRead;
#ifdef WIN32
    HANDLE hFile;

    hFile = *(HANDLE *)p;
    SetFilePointer(hFile, Off, 0, FILE_BEGIN);
    ReadFile(hFile, (U8 *)*ppData, NumBytes, &NumBytesRead, NULL);
#else
    FS_FILE * pFile;

    pFile = (FS_FILE *)p;
    FS_SetFilePos(pFile, Off, FS_FILE_BEGIN);
    NumBytesRead = FS_Read(pFile, (U8 *)*ppData, NumBytes);
#endif
    return NumBytesRead;
}

/*****
 *
 *      _cbNotify
 *
 *****/

```

```

* Function description
*   Uses multiple buffering (if available) to avoid tearing effects.
*/
static void _cbNotify(GUI_HMEM hMovie, int Notification, U32 CurrentFrame) {
    GUI_USE_PARA(hMovie);
    GUI_USE_PARA(CurrentFrame);
    switch (Notification) {
        case GUI_MOVIE_NOTIFICATION_PREDRAW:
            //
            // Begin multi-buffering if available.
            //
            GUI_MULTIBUF_Begin();
            break;
        case GUI_MOVIE_NOTIFICATION_POSTDRAW:
        case GUI_MOVIE_NOTIFICATION_PREDRAW:
            //
            // End multi-buffering.
            //
            GUI_MULTIBUF_End();
            break;
        case GUI_MOVIE_NOTIFICATION_START:
            break;
        case GUI_MOVIE_NOTIFICATION_STOP:
            break;
    }
}

/*****
*
*   Public code
*
*****/
*/
/*****
*
*   MainTask
*
*****/
void MainTask(void) {
    GUI_MOVIE_HANDLE hMovie;
    GUI_MOVIE_INFO Info;
#ifdef WIN32
    HANDLE hFile;
    #define PARAM &hFile
#else
    FS_FILE * pFile;
    const char acVolumeName[64];
    #define PARAM pFile
#endif

    //
    // Init emWin.
    //
    GUI_Init();
    GUI_Clear();

#ifdef WIN32
    hFile = CreateFile(FILE_PATH, GENERIC_READ, 0, 0, OPEN_EXISTING, FILE_ATTRIBUTE_NORMAL, 0);
#else
    //
    // Start emFile.
    //
    FS_Init();
    //
    // Enable long file name support.
    //
    FS_FAT_SupportLFN();
    //
    // Mount volume.

```

```
//
FS_GetVolumeName(0, acVolumeName, sizeof(acVolumeName));
if (FS_Mount(acVolumeName) > 0) {
    //
    // Open file.
    //
    pFile = FS_FOpen(FILE_PATH, "r");
}
#endif
//
// Get info about movie.
//
if(GUI_MOVIE_GetInfoEx(_GetData, PARAM, &Info) == 0) {
    //
    // Create movie handle and show it in an endless loop.
    //
    hMovie = GUI_MOVIE_CreateEx(_GetData, PARAM, _cbNotify);
    if (hMovie) {
        GUI_MOVIE_Show(hMovie, 0, 0, 1);
    }
}

while (1) {
    GUI_Delay(100);
}

/***** End of file *****/
```

## 5.8.9 emWin Movie Player

Every emWin shipment comes with a tool named emWinPlayer. This tool makes it possible to show the previously created EMF on a Computer with a Windows operating system. This might come in handy since there is no need of a running application to watch the created EMF.

When using the emWinPlayer it provides the user with information about the currently running EMF. It shows the currently displayed frame and the time of this frame. This will make it easier to change the movie at a specific position.

To show an EMF either open a file via the menu bar or 'drag and drop' the file to be played into the player. The EMF starts playing automatically. The control panel allows to jump at the beginning or the end of movie, step frame wise and to play/pause the movie file. With a click on the progress bar it is also possible to jump to a position in the movie.

### Limitations

The emWin movie player does not yet support bitmap-based EMFs.

### Screenshot of the tool



## 5.8.10 Movies API

The table below lists the available movie-related routines in alphabetical order. Detailed descriptions follow:

### Functions

| Routine                                | Description   |
|--|---|
| <code>GUI_MOVIE_Create()</code>        | Creates a movie using a file which is completely available in addressable RAM or ROM.                                   |
| <code>GUI_MOVIE_CreateEx()</code>      | Creates a movie using a file which is not available in addressable RAM or ROM.  |
| <code>GUI_MOVIE_Delete()</code>        | Deletes the given movie from memory.  |
| <code>GUI_MOVIE_DrawFrame()</code>     | Draws a single frame of a movie.  |
| <code>GUI_MOVIE_GetFrameIndex()</code> | Returns the current frame number of the given movie.  |
| <code>GUI_MOVIE_GetInfo()</code>       | Fills a <code>GUI_MOVIE_INFO</code> structure with information about the given movie.                                   |
| <code>GUI_MOVIE_GetInfoEx()</code>     | Fills a <code>GUI_MOVIE_INFO</code> structure with information about the given movie not being available in RAM or ROM. |
| <code>GUI_MOVIE_GetInfoH()</code>      | Fills a <code>GUI_MOVIE_INFO</code> structure with information about the given movie using an existing movie handle.    |
| <code>GUI_MOVIE_GetNumFrames()</code>  | Returns the number of frames of a movie.  |
| <code>GUI_MOVIE_GetPos()</code>        | Returns the drawing position and resolution of the given movie.   |
| <code>GUI_MOVIE_GotoFrame()</code>     | Sets the frame index to be shown at next.   |
| <code>GUI_MOVIE_Pause()</code>         | Stops playing the given movie immediately.  |
| <code>GUI_MOVIE_Play()</code>          | Continues playing of the given movie.   |
| <code>GUI_MOVIE_SetPeriod()</code>     | Sets the period to be used for one single frame in ms.  |
| <code>GUI_MOVIE_SetpfNotify()</code>   | Set a notification callback function.   |
| <code>GUI_MOVIE_SetPos()</code>        | Sets the drawing position to be used for the given movie.   |
| <code>GUI_MOVIE_Show()</code>          | Starts playing the given movie at the given position.   |

### Data structures

| Structure                   | Description                |
|-----------------------------|----------------------------|
| <code>GUI_MOVIE_INFO</code> | Information about a movie. |

### Defines

| Group of defines                 | Description  |
|----------------------------------|--|
| <code>Movie notifications</code> | Notifications sent to the movie's callback function. |



## 5.8.10.1 Functions

### 5.8.10.1.1 GUI\_MOVIE\_Create()

#### Description

Creates a movie using a file which is completely available in addressable RAM or ROM.

#### Prototype

```
GUI_MOVIE_HANDLE GUI_MOVIE_Create(const void          * pFileData,
                                  U32                FileSize,
                                  GUI_MOVIE_FUNC * pfNotify);
```

#### Parameters

| Parameter              | Description   |
|------------------------|---|
| <code>pFileData</code> | Pointer to the memory location of the file.   |
| <code>FileSize</code>  | Size of file in bytes.  |
| <code>pfNotify</code>  | Optional pointer to a notification function of type <code>GUI_MOVIE_FUNC</code> . If set, this function would be called for each frame. |

#### Prototype of GUI\_MOVIE\_FUNC

```
void GUI_MOVIE_FUNC(GUI_MOVIE_HANDLE hMovie,
                    int              Notification,
                    U32              CurrentFrame);
```

The permitted values for the `Notification` parameter are listed under *Movie notifications* on page 671.

#### Return value

Movie handle on success, 0 on error.

#### Additional information

The callback function can be used to achieve overlays for specific frames or for using multiple buffers for the drawing process. The sample folder contains the sample `BASIC_ShowMovies.c` which shows how to use that feature in detail.

### 5.8.10.1.2 GUI\_MOVIE\_CreateEx()

#### Description

Creates a movie using a file which is not available in addressable RAM or ROM. A user defined GetData() function is used to fetch the file data.

#### Prototype

```
GUI_MOVIE_HANDLE GUI_MOVIE_CreateEx(GUI_GET_DATA_FUNC * pfGetData,
                                     void * pParam,
                                     GUI_MOVIE_FUNC * pfNotify);
```

#### Parameters

| Parameter              | Description   |
|------------------------|---|
| <code>pfGetData</code> | Pointer to a function which is called for getting data. Details about the GetData() function can be found in the section <i>Getting data with the ...Ex() functions</i> on page 476 |
| <code>pParam</code>    | Void pointer passed to the function pointed by <code>pfGetData</code> .   |
| <code>pfNotify</code>  | Optional pointer to a notification function as described under <code>GUI_MOVIE_Create()</code> .  |

#### Return value

Movie handle on success, 0 on error.

#### Additional information

When playing a movie not from an addressable memory location, the movie function of emWin reads the file frame by frame. That means that only one file access is required for each frame. But that also means that enough RAM needs to be available for buffering a complete JPEG file. For more information please also refer to `GUI_MOVIE_Create()`.

### 5.8.10.1.3 GUI\_MOVIE\_Delete()

#### Description

Deletes the given movie from memory.

#### Prototype

```
int GUI_MOVIE_Delete(GUI_MOVIE_HANDLE hMovie);
```

#### Parameters

| Parameter           | Description                        |
|---------------------|------------------------------------|
| <code>hMovie</code> | Handle to the movie to be deleted. |

#### Return value

0        on success  
1        on error.

#### Additional information

If the movie is currently playing, the function stops it. It is not required to call `GUI_MOVIE_Stop()` explicitly.

### 5.8.10.1.4 GUI\_MOVIE\_DrawFrame()

#### Description

Draws the given frame of the movie at the given position.

#### Prototype

```
void GUI_MOVIE_DrawFrame(GUI_MOVIE_HANDLE hMovie,  
                          int             Index,  
                          int             x,  
                          int             y);
```

#### Parameters

| Parameter              | Description                                     |
|------------------------|---|
| <a href="#">hMovie</a> | Handle to the movie to be deleted.              |
| <a href="#">Index</a>  | <a href="#">Index</a> of the frame to be shows. |
| <a href="#">x</a>      | X-position in screen coordinates to be used.    |
| <a href="#">y</a>      | Y-position in screen coordinates to be used.    |

### 5.8.10.1.5 GUI\_MOVIE\_GetFrameIndex()

#### Description

If the movie is already playing the function returns the index of the next frame to be shown. If the movie is currently stopped/paused, it returns the frame index of the last shown image.

#### Prototype

```
U32 GUI_MOVIE_GetFrameIndex(GUI_MOVIE_HANDLE hMovie);
```

#### Parameters

| Parameter              | Description                        |
|------------------------|------------------------------------|
| <a href="#">hMovie</a> | Handle to the movie to be deleted. |

#### Return value

Frame index as described above.

### 5.8.10.1.6 GUI\_MOVIE\_GetInfo()

#### Description

Fills a `GUI_MOVIE_INFO` structure with information about the given movie. The movie needs to be available in an addressable memory location.

#### Prototype

```
int GUI_MOVIE_GetInfo(const void      * pFileData,
                    U32             FileSize,
                    GUI_MOVIE_INFO * pInfo);
```

#### Parameters

| Parameter              | Description  |
|------------------------|--|
| <code>pFileData</code> | Pointer to the memory location of the file.  |
| <code>FileSize</code>  | Size of file in bytes.   |
| <code>pInfo</code>     | Pointer to a structure of type <code>GUI_MOVIE_INFO</code> to be filled by the function. |

#### Return value

0        on success  
1        on error.

### 5.8.10.1.7 GUI\_MOVIE\_GetInfoEx()

#### Description

Fills a `GUI_MOVIE_INFO` structure with information about the given movie. The movie does not need to be available in an addressable memory location.

#### Prototype

```
int GUI_MOVIE_GetInfoEx(GUI_GET_DATA_FUNC * pfGetData,
                       void * pParam,
                       GUI_MOVIE_INFO * pInfo);
```

#### Parameters

| Parameter              | Description  |
|------------------------|--|
| <code>pfGetData</code> | Pointer to a function which is called for getting data. Details about the <code>GetData()</code> function can be found in the section <i>Getting data with the ...Ex() functions</i> on page 476 |
| <code>pParam</code>    | Void pointer passed to the function pointed by <code>pfGetData</code> .  |
| <code>pInfo</code>     | Pointer to a structure of type <code>GUI_MOVIE_INFO</code> to be filled by the function.   |

#### Return value

0        on success  
1        on error.

### 5.8.10.1.8 GUI\_MOVIE\_GetInfoH()

#### Description

Fills a `GUI_MOVIE_INFO` structure with information about the given movie using an existing movie handle.

#### Prototype

```
int GUI_MOVIE_GetInfoH(GUI_MOVIE_HANDLE hMovie,  
                      GUI_MOVIE_INFO * pInfo);
```

#### Parameters

| Parameter           | Description  |
|---------------------|--|
| <code>hMovie</code> | Handle of the movie.   |
| <code>pInfo</code>  | Pointer to a structure of type <code>GUI_MOVIE_INFO</code> to be filled by the function. |

#### Return value

0        on success  
1        on error.



### 5.8.10.1.9 GUI\_MOVIE\_GetNumFrames()

#### Description

Returns the number of frames of a movie.

#### Prototype

```
int GUI_MOVIE_GetNumFrames(GUI_MOVIE_HANDLE hMovie);
```

#### Parameters

| Parameter              | Description          |
|------------------------|----------------------|
| <a href="#">hMovie</a> | Handle of the movie. |

#### Return value

Number of frames present in the movie.

### 5.8.10.1.10 GUI\_MOVIE\_GetPos()

#### Description

Returns the drawing position and resolution of the given movie.

#### Prototype

```
int GUI_MOVIE_GetPos(GUI_MOVIE_HANDLE hMovie,
                    int * pxPos,
                    int * pyPos,
                    int * pxSize,
                    int * pySize);
```

#### Parameters

| Parameter           | Description  |
|---------------------|--|
| <code>hMovie</code> | Handle of the movie.   |
| <code>pxPos</code>  | Pointer to an integer to be filled with the drawing position in x. May be <code>NULL</code> .      |
| <code>pyPos</code>  | Pointer to an integer to be filled with the drawing position in y. May be <code>NULL</code> .      |
| <code>pxSize</code> | Pointer to an integer to be filled with the horizontal resolution in x. May be <code>NULL</code> . |
| <code>pySize</code> | Pointer to an integer to be filled with the horizontal resolution in y. May be <code>NULL</code> . |

#### Return value

0        on success  
1        on error.

### 5.8.10.1.11 GUI\_MOVIE\_GotoFrame()

#### Description

Sets the frame index to be shown at next.

#### Prototype

```
int GUI_MOVIE_GotoFrame(GUI_MOVIE_HANDLE hMovie,  
                        U32                Frame);
```

#### Parameters

| Parameter           | Description                  |
|---------------------|------------------------------|
| <code>hMovie</code> | Handle of the movie.         |
| <code>Frame</code>  | Number of the desired frame. |

#### Return value

0        on success  
1        on error.

#### Additional information

If the given frame index is not in the range of the given file, the function stops the movie and returns with an error.

### 5.8.10.1.12 GUI\_MOVIE\_Pause()

#### Description

Stops playing the given movie immediately. Can be continued later with `GUI_MOVIE_Play()`.

#### Prototype

```
int GUI_MOVIE_Pause(GUI_MOVIE_HANDLE hMovie);
```

#### Parameters

| Parameter           | Description          |
|---------------------|----------------------|
| <code>hMovie</code> | Handle of the movie. |

#### Return value

0        on success  
1        on error.

### 5.8.10.1.13 GUI\_MOVIE\_Play()

#### Description

Continues playing of the given movie.

#### Prototype

```
int GUI_MOVIE_Play(GUI_MOVIE_HANDLE hMovie);
```

#### Parameters

| Parameter           | Description          |
|---------------------|----------------------|
| <code>hMovie</code> | Handle of the movie. |

#### Return value

0        on success  
1        on error.

### 5.8.10.1.14 GUI\_MOVIE\_SetPeriod()

#### Description

Sets the period to be used for one single frame in ms.

#### Prototype

```
int GUI_MOVIE_SetPeriod(GUI_MOVIE_HANDLE hMovie,  
                        unsigned          Period);
```

#### Parameters

| Parameter           | Description                           |
|---------------------|---------------------------------------|
| <code>hMovie</code> | Handle of the movie.                  |
| <code>Period</code> | <code>Period</code> to be used in ms. |

#### Return value

0        on success  
1        on error.

#### Additional information

This function can be used to vary the speed of a movie. If the period is too short to be achieved by the hardware emWin skips the next image(s).

### 5.8.10.1.15 GUI\_MOVIE\_SetpfNotify()

#### Description

This function should be used when the JPEG decoding is performed by hardware. `GUI_MOVIE_SetpfNotify()` sets a callback function to signalize if a movie is running or not. An example on how to use this function can be found under `Sample\JPEG-Conf\STM32F769`. Further it is required to set up hardware decoding by hardware. Please refer to *Using hardware JPEG decoding* on page .

#### Prototype

```
void GUI_MOVIE_SetpfNotify(GUI_MOVIE_FUNC * pfNotify);
```

#### Parameters

| Parameter           | Description                           |
|---------------------|---------------------------------------|
| <code>hMovie</code> | Handle of the movie.                  |
| <code>Period</code> | <code>Period</code> to be used in ms. |

#### Return value

0        on success  
1        on error.

#### Additional information

The parameter `pfNotify` has the same prototype as described at *Prototype of GUI\_MOVIE\_FUNC*. Although it has the same prototype, it has not the functionality. The intention of this function pointer is to signal when a movie starts and ends.

### 5.8.10.1.16 GUI\_MOVIE\_SetPos()

#### Description

Sets the drawing position to be used for the given movie.

#### Prototype

```
int GUI_MOVIE_SetPos(GUI_MOVIE_HANDLE hMovie,  
                    int                xPos,  
                    int                yPos);
```

#### Parameters

| Parameter              | Description                                  |
|------------------------|--|
| <a href="#">hMovie</a> | Handle of the movie.                         |
| <a href="#">xPos</a>   | X-position in screen coordinates to be used. |
| <a href="#">yPos</a>   | Y-position in screen coordinates to be used. |

#### Return value

0        on success  
1        on error.

#### Additional information

It is not required that the given position makes the movie completely visible. It can be partly or completely outside of the visible screen.



### 5.8.10.1.17 GUI\_MOVIE\_Show()

#### Description

Starts playing the given movie at the given position.

#### Prototype

```
int GUI_MOVIE_Show(GUI_MOVIE_HANDLE hMovie,  
                  int                xPos,  
                  int                yPos,  
                  int                DoLoop);
```

#### Parameters

| Parameter              | Description  |
|------------------------|--|
| <a href="#">hMovie</a> | Handle of the movie.   |
| <a href="#">xPos</a>   | X-position in screen coordinates to be used.                 |
| <a href="#">yPos</a>   | Y-position in screen coordinates to be used.                 |
| <a href="#">DoLoop</a> | 1 if the movie should be shown in an endless loop, 0 if not. |

#### Return value

0        on success  
1        on error.

#### Additional information

If the given movie is already playing the function returns an error. But the movie remains playing.

## 5.8.10.2 Data structures

### 5.8.10.2.1 GUI\_MOVIE\_INFO

#### Description

Information about a movie.

#### Type definition

```
typedef struct {  
    int  xSize;  
    int  ySize;  
    int  msPerFrame;  
    U32  NumFrames;  
} GUI_MOVIE_INFO;
```

#### Structure members

| Member                     | Description                                   |
|----------------------------|---|
| <a href="#">xSize</a>      | Horizontal resolution of the movie in pixels. |
| <a href="#">ySize</a>      | Vertical resolution of the movie in pixels.   |
| <a href="#">msPerFrame</a> | Period of one frame in ms.                    |
| <a href="#">NumFrames</a>  | Number of frames of the movie file.           |

#### See also

- [GUI\\_MOVIE\\_GetInfo\(\)](#)
- [GUI\\_MOVIE\\_GetInfoEx\(\)](#)

## 5.8.10.3 Defines

### 5.8.10.3.1 Movie notifications

#### Description

Notifications sent to the movie's callback function. The callback function can be set with `GUI_MOVIE_SetpfNotify()`.

#### Definition

```
#define GUI_MOVIE_NOTIFICATION_PREDRAW      0
#define GUI_MOVIE_NOTIFICATION_POSTDRAW    1
#define GUI_MOVIE_NOTIFICATION_START       2
#define GUI_MOVIE_NOTIFICATION_STOP        3
#define GUI_MOVIE_NOTIFICATION_DELETE      4
```

#### Symbols

| Definition                                   | Description                               |
|--|---|
| <code>GUI_MOVIE_NOTIFICATION_PREDRAW</code>  | Sent immediately before a frame is drawn. |
| <code>GUI_MOVIE_NOTIFICATION_POSTDRAW</code> | Sent immediately after a frame is drawn.  |
| <code>GUI_MOVIE_NOTIFICATION_START</code>    | Sent when starting to play a movie.       |
| <code>GUI_MOVIE_NOTIFICATION_STOP</code>     | Sent when the movie has stopped.          |
| <code>GUI_MOVIE_NOTIFICATION_DELETE</code>   | Sent when the movie has been deleted.     |

## 5.9 Pointer Input Devices

emWin provides support for pointer-input-devices. Pointer input devices can be touch-screen, mouse or joystick. The basic emWin package includes a driver for analog touch-screens, a PS2 mouse driver, as well as an example joystick driver. Other types of touch-panel and mouse devices can also be used with the appropriate drivers.

The software for input devices is located in the subdirectory `GUI\Core`.

### 5.9.1 Description

Pointer input devices are devices such as mice, touch-screens and joysticks. Multiple pointer input devices can be used in a single application to enable simultaneous mouse/touch-screen/joystick use. Basically all a PID driver does is calling the routine `GUI_PID_StoreState()` whenever an event (such as a moved mouse, or a pressed touch screen) has been detected.

PID events are stored in a FIFO which is processed by the Window Manager. If the Window Manager is not used (respectively deactivated), the application is responsible for reacting on PID events.

### 5.9.2 Pointer input device API

The table below lists the pointer input device routines in alphabetical order. Detailed descriptions follow.

#### Note

This API is used by the PID-driver; if you use a PID-driver shipped with emWin, your code does not need to call these routines.

#### Functions

| Routine                                | Description   |
|--|---|
| <code>GUI_PID_GetCurrentState()</code> | Fills the given <code>GUI_PID_STATE</code> structure with the most recently stored PID state.   |
| <code>GUI_PID_GetState()</code>        | Fills the given <code>GUI_PID_STATE</code> structure with the current state information and returns if the input device is currently pressed. |
| <code>GUI_PID_IsEmpty()</code>         | Returns if the PID buffer is empty.   |
| <code>GUI_PID_IsPressed()</code>       | Returns if the most recent state of the PID is pressed.   |
| <code>GUI_PID_SetHook()</code>         | Sets an optional function to be called immediately before storing a new PID event into the input buffer.                                      |
| <code>GUI_PID_StoreState()</code>      | Stores the current state of the pointer input device.   |

#### Data structures

| Structure                  | Description                                      |
|----------------------------|--|
| <code>GUI_PID_STATE</code> | Stores the position of the pointer input device. |

## 5.9.2.1 Functions

### 5.9.2.1.1 GUI\_PID\_GetCurrentState()

#### Description

Fills the given `GUI_PID_STATE` structure with the most recently stored PID state.

#### Prototype

```
void GUI_PID_GetCurrentState(GUI_PID_STATE * pState);
```

#### Parameters

| Parameter           | Description  |
|---------------------|--|
| <code>pState</code> | Pointer to a <code>GUI_PID_STATE</code> structure. |

#### Additional information

This function performs a non-destructive read on the PID FIFO.

### 5.9.2.1.2 GUI\_PID\_GetState()

#### Description

Fills the given `GUI_PID_STATE` structure with the current state information and returns if the input device is currently pressed.

#### Prototype

```
int GUI_PID_GetState(GUI_PID_STATE * pState);
```

#### Parameters

| Parameter           | Description  |
|---------------------|--|
| <code>pState</code> | Pointer to a <code>GUI_PID_STATE</code> structure. |

#### Return value

1 if input device is currently pressed  
0 if not pressed.

#### Additional information

This function does a destructive read on the `PID FIFO`: If the `FIFO` contains unread values, it reads and eliminates the first value in the `FIFO`. If the `FIFO` is empty, it returns the last value written to it. If no value has ever been written into the `PID FIFO`, all values in `pState` are set to 0.

#### Example

```
GUI_PID_STATE State;  
GUI_PID_GetState(&State);
```

### 5.9.2.1.3 GUI\_PID\_IsEmpty()

#### Description

Returns if the PID buffer is empty.

#### Prototype

```
int GUI_PID_IsEmpty(void);
```

#### Return value

- 1 if the PID buffer is empty.
- 0 if entries were found in the PID buffer.

#### 5.9.2.1.4 GUI\_PID\_IsPressed()

##### Description

Returns if the most recent state of the PID is pressed.

##### Prototype

```
int GUI_PID_IsPressed(void);
```

##### Return value

1        if input device is currently pressed  
0        if not pressed.

##### Additional information

This function does not modify the `PID FIFO`.



### 5.9.2.1.5 GUI\_PID\_SetHook()

#### Description

Sets an optional function to be called immediately before storing a new PID event into the input buffer.

#### Prototype

```
void GUI_PID_SetHook(void ( *pfHook)(GUI_PID_STATE * ));
```

#### Parameters

| Parameter           | Description  |
|---------------------|--|
| <code>pfHook</code> | Pointer to a function which is called immediately before a new PID event is added to the input buffer. |

#### Additional information

This function is usefull if it is required to have widgets within multiple layers. Dependent on the given coordinates the element 'Layer' could be modified before the data is added to the input buffer. Please be aware that this function is called by directly by `GUI_PID_storeState()`. In case of using a touch ISR it is called from that ISR. Calling further GUI functions within the hook function is not allowed. Please keep in mind that this function can be called very often and keep the workload low.

### 5.9.2.1.6 GUI\_PID\_StoreState()

#### Description

Stores the current state of the pointer input device.

#### Prototype

```
void GUI_PID_StoreState(const GUI_PID_STATE * pState);
```

#### Parameters

| Parameter           | Description   |
|---------------------|---|
| <code>pState</code> | Pointer to a structure of type <code>GUI_PID_STATE</code> . |

#### Additional information

This function can be used from an interrupt service routine. The PID input manager of emWin contains a FIFO buffer which is able to hold up to 5 PID events per default. If a different size is required this value can be changed. Details can be found in the section *Advanced GUI configuration options* on page 129.

## 5.9.2.2 Data structures

### 5.9.2.2.1 GUI\_PID\_STATE

#### Description

Stores the position of the pointer input device.

#### Type definition

```
typedef struct {
    int    x;
    int    y;
    U8     Pressed;
    U8     Layer;
} GUI_PID_STATE;
```

#### Structure members

| Member               | Description  |
|----------------------|--|
| <code>x</code>       | Horizontal position of the PID in window coordinates.  |
| <code>y</code>       | Vertical position of the PID in window coordinates.  |
| <code>Pressed</code> | <p>If the message is originated by a touch screen this value can be 0 (unpressed) or 1 (pressed).</p> <p>If the message is originated by a mouse each bit represents a mouse button (0 for unpressed and 1 for pressed state):</p> <ul style="list-style-type: none"> <li>• Bit 0 represents the first button (normally the left button)</li> <li>• Bit 1 represents the second button (normally the right button)</li> <li>• Bit 2 represents the third button (normally the middle button)</li> </ul> <p>The remaining bits can be used for further buttons.</p> |
| <code>Layer</code>   | ID of layer.   |

## 5.9.3 Mouse driver

Mouse support consists of two “layers”: a generic layer and a mouse driver layer. Generic routines refer to those functions which always exist, no matter what type of mouse driver you use. The available mouse driver routines, on the other hand, will call the appropriate generic routines as necessary, and may only be used with the PS2 mouse driver supplied with emWin. If you write your own driver, it is responsible for calling the generic routines.

The generic mouse routines will in turn call the corresponding PID routines.

### 5.9.3.1 Generic mouse driver API

The table below lists the generic mouse routines in alphabetical order. These functions may be used with any type of mouse driver. Detailed descriptions follow.

| Routine                                | Description                             |
|--|---|
| <a href="#">GUI_MOUSE_GetState()</a>   | Returns the current state of the mouse. |
| <a href="#">GUI_MOUSE_StoreState()</a> | Stores the current state of the mouse.  |

### 5.9.3.1.1 GUI\_MOUSE\_GetState()

#### Description

Returns the current state of the mouse.

#### Prototype

```
int GUI_MOUSE_GetState(GUI_PID_STATE * pState);
```

#### Parameters

| Parameter           | Description   |
|---------------------|---|
| <code>pState</code> | Pointer to a structure of type <code>GUI_PID_STATE</code> . |

#### Return value

1 if mouse is currently pressed.  
0 if not pressed.

#### Additional information

This function will call `GUI_PID_GetState()`.

### 5.9.3.1.2 GUI\_MOUSE\_StoreState()

#### Description

Stores the current state of the mouse.

#### Prototype

```
void GUI_MOUSE_StoreState(const GUI_PID_STATE * pState);
```

#### Parameters

| Parameter           | Description   |
|---------------------|---|
| <code>pState</code> | Pointer to a structure of type <code>GUI_PID_STATE</code> . |

#### Additional information

This function will call `GUI_PID_StoreState()`. This function can be used from an interrupt service routine.

#### Example

```
GUI_PID_STATE State;
State.x = _MousepositionX; /* Screen position in X of mouse device */
State.y = _MousepositionY; /* Screen position in Y of mouse device */
State.Pressed = 0;
if (_LeftButtonPressed) {
    State.Pressed |= 1; /* Set bit 0 if left button is pressed */
}
if (_RightButtonPressed) {
    State.Pressed |= 2; /* Set bit 1 if right button is pressed */
}
GUI_MOUSE_StoreState(&State);
```

### 5.9.3.2 PS2 mouse driver

The driver supports any type of PS2 mouse

#### 5.9.3.2.1 Using the PS2 mouse driver

The driver is very easy to use. In the startup code, the initialization function `GUI_MOUSE_DRIVER_PS2_Init()` should be called. The application should somehow notice when a byte is received from the mouse. When this happens, the function `GUI_MOUSE_DRIVER_PS2_OnRx()` should be called and the byte received passed as parameter. The driver in turn then calls `GUI_PID_StoreState` as required. The reception of the byte is typically handled in an interrupt service routine.

An example ISR could look as follows: (Note that this is of course different for different systems)

```

void interrupt OnRx(void) {
    char Data;
    Data = UART_REG;           // Read data from the hardware
    GUI_MOUSE_DRIVER_PS2_OnRx(Data); // Pass it on to the driver
}

```

#### 5.9.3.2.2 PS2 mouse driver API

The table below lists the available mouse driver routines in alphabetical order.

| Routine                                  | Description                                     |
|--|---|
| <code>GUI_MOUSE_DRIVER_PS2_Init()</code> | Initializes the mouse driver.                   |
| <code>GUI_MOUSE_DRIVER_PS2_OnRx()</code> | Must be called from receive interrupt routines. |

### 5.9.3.2.2.1 GUI\_MOUSE\_DRIVER\_PS2\_Init()

#### Description

Initializes the mouse driver.

#### Prototype

```
void GUI_MOUSE_DRIVER_PS2_Init(void);
```



### 5.9.3.2.2 GUI\_MOUSE\_DRIVER\_PS2\_OnRx()

#### Description

Must be called from receive interrupt routines.

#### Prototype

```
void GUI_MOUSE_DRIVER_PS2_OnRx(unsigned char Data);
```

#### Parameters

| Parameter | Description                   |
|-----------|-------------------------------|
| Data      | Byte of data received by ISR. |

#### Additional information

The PS2 mouse driver is a serial driver, meaning it receives 1 byte at a time. You need to ensure that this function is called from your receive interrupt routine every time a byte (1 character) is received.

## 5.9.4 Touch screen driver

A touch screen driver will typically simply call `GUI_PID_StoreState()` as described earlier. Any type of touch screen can be supported this way. It is the responsibility of the user to write the driver code (which is usually fairly simple).

The most common way of interfacing a touch screen is the 4-pin analog interface, for which a driver is supplied.

### 5.9.4.1 Generic touch screen API

The generic touch screen API is used with any type of driver (analog, digital, etc.). A driver calls the appropriate routines as necessary. If you write your own driver, it has to call the generic routines.

The table below lists the generic touch-screen routines in alphabetical order. These functions may be used with any type of touch-screen driver. Detailed descriptions follow.

| Routine                               | Description  |
|---------------------------------------|--|
| <code>GUI_TOUCH_GetState()</code>     | Returns the current state of the touch-screen.   |
| <code>GUI_TOUCH_StoreState()</code>   | Stores the current state of the touch screen using X- and Y-coordinates as parameters. |
| <code>GUI_TOUCH_StoreStateEx()</code> | Stores the current state of the touch screen.  |

### 5.9.4.1.1 GUI\_TOUCH\_GetState()

#### Description

Returns the current state of the touch-screen.

#### Prototype

```
int GUI_TOUCH_GetState(GUI_PID_STATE * pState);
```

#### Parameters

| Parameter           | Description   |
|---------------------|---|
| <code>pState</code> | Pointer to a structure of type <code>GUI_PID_STATE</code> . |

#### Return value

- 1 if touch-screen is currently pressed.
- 0 if not pressed.

### 5.9.4.1.2 GUI\_TOUCH\_StoreState()

#### Description

Stores the current state of the touch screen using X- and Y-coordinates as parameters.

#### Prototype

```
void GUI_TOUCH_StoreState(int x,  
                          int y);
```

#### Parameters

| Parameter | Description |
|-----------|-------------|
| x         | X-position. |
| y         | Y-position. |

#### Additional information

This function can be used from an interrupt service routine. It calls the function `GUI_PID_StoreState()`. It is assumed that the touch panel is not pressed, if this function is called with negative values. A detailed example of a touch handling routine can be found in `Sample\GUI_X\GUI_X_Touch_StoreState.c`.

#### Example

```
int x, y;  
if (_TouchIsPressed) {  
    x = _TouchPositionX; /* Current position in X of touch device */  
    y = _TouchPositionY; /* Current position in Y of touch device */  
} else {  
    x = y = -1;          /* Use -1 if touch is not pressed */  
}  
GUI_TOUCH_StoreState(x, y);
```

### 5.9.4.1.3 GUI\_TOUCH\_StoreStateEx()

#### Description

Stores the current state of the touch screen.

#### Prototype

```
void GUI_TOUCH_StoreStateEx(const GUI_PID_STATE * pState);
```

#### Parameters

| Parameter           | Description   |
|---------------------|---|
| <code>pState</code> | Pointer to a structure of type <code>GUI_PID_STATE</code> . |

#### Additional information

This function will call `GUI_PID_StoreState()`. A detailed example of a touch handling routine can be found in `Sample\GUI_X\GUI_X_Touch_StoreState.c`.

#### Example

```
GUI_PID_STATE State;
State.x = _TouchPositionX;
State.y = _TouchPositionY;
if (_TouchIsPressed) {
    State.Pressed = 1;
} else {
    State.Pressed = 0;
}
GUI_TOUCH_StoreStateEx(&State);
```

### 5.9.4.2 The analog touch screen driver

The emWin touch-screen driver handles analog input (from an 8-bit or better A/D converter), debouncing and calibration of the touch-screen. The touch-screen driver continuously monitors and updates the touch-panel through the use of the function `GUI_TOUCH_Exec()`, which calls the appropriate generic touchscreen API routines when it recognizes that an action has been performed or something has changed.

#### How an analog touch screen works

The touch panel consists of 2 thin conducting layers of glass, normally insulated from each other. If the user presses the touch panel, the two layers are connected at that point. If a voltage is applied to the Y-layer, when pressed, a voltage can be measured at the X+/X-terminals. This voltage depends on the touch position. The same thing holds true the other way round. If a voltage is applied to the X-layer, when pressed, a voltage can be measured at the Y+/Y-terminals.

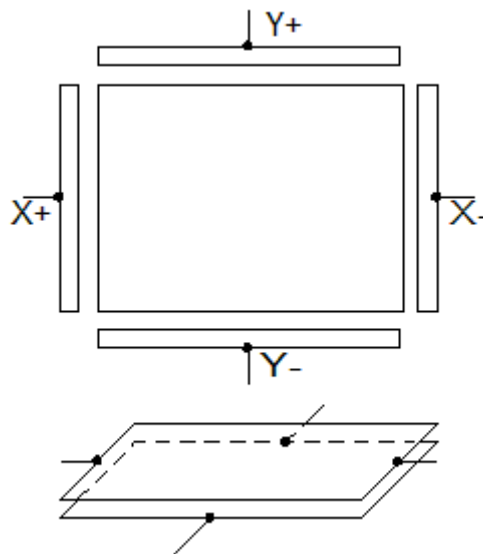

#### 5.9.4.2.1 Setting up the analog touch screen

Putting a touch panel into operation should be done in the following steps:

- Implementing the hardware routines
- Implementing regular calls to `GUI_TOUCH_Exec()`
- Verifying proper operation with the oscilloscope
- Using example to determine calibration values
- Adding a call of `GUI_TOUCH_Calibrate()` to the initialization routine `LCD_X_Config()` using the determined values

The following shows a detailed description of each step.

#### Implementing the hardware routines

The first step of implementing a touch screen should be filling the hardware routines with code. These routines are:

- `GUI_TOUCH_X_ActivateX()` and `GUI_TOUCH_X_ActivateY()`
- `GUI_TOUCH_X_MeasureX()` and `GUI_TOUCH_X_MeasureY()`

A module `GUI_TOUCH_X.c` containing the empty routines is located in the folder `Sample\GUI_X`. You can use this module as a starting point. The activate routines should prepare the measurement by switching on the measurement voltage. `GUI_TOUCH_X_ActivateX()` for example should prepare the measurement in Y by switching on the measurement voltage in X. Further it should switch of the voltage in Y and disable the measurement in X. The measurement routines should return the measurement result of a A/D converter. Later in this chapter you will find an example implementation of the hardware routines.

### Implementing regular calls to GUI\_TOUCH\_Exec()

The second step of implementing a touch screen is to make sure, that the function GUI\_TOUCH\_Exec() will be called in regular intervals. The application should call it about 100 times/second. If a real-time operating system is used, the easiest way to make sure this function is called is to create a separate task. When not using a multitasking system, an interrupt service routine may do the job. The function GUI\_TOUCH\_Exec() measures x- and y-axis in turns. So complete measurements are done once both axes were measured.

### Verifying proper operation with the oscilloscope

After implementing the call of GUI\_TOUCH\_Exec() make sure the hardware works. The easiest way to do this is to measure the supply and measurement voltages of the touch panel with a oscilloscope. The following table shows a typical result. The first column shows the supply voltage of an axis, the second column shows the result of measuring the measurement voltage when pressing in the middle of the touch panel.

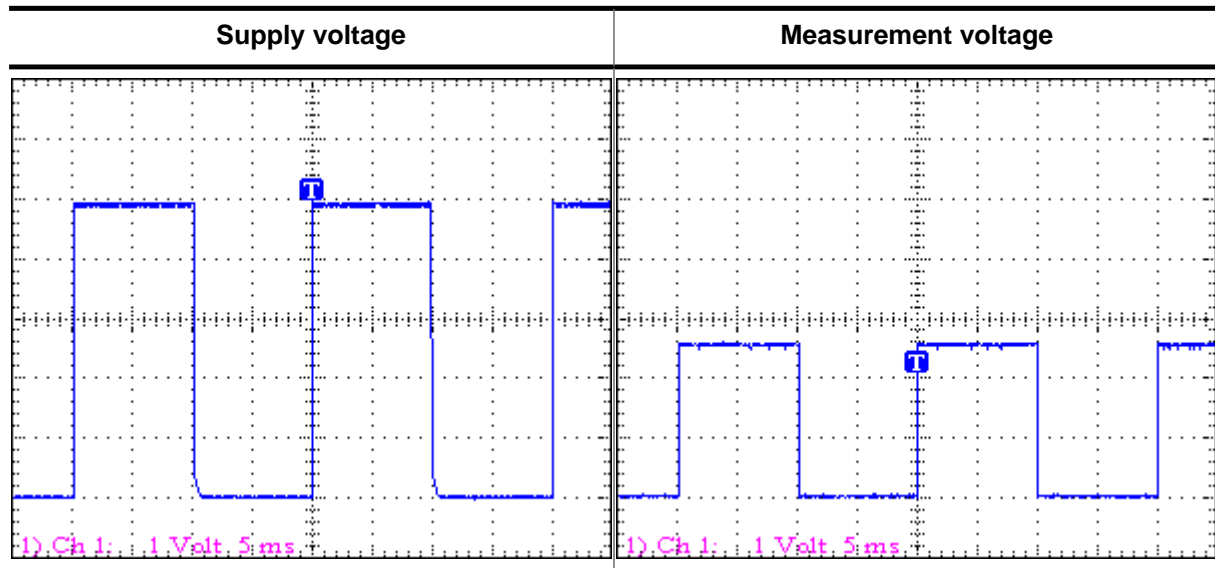

### Use example to determine calibration values

The third step is to get the minimum and maximum values of the A/D converter. emWin needs this values to convert the measurement result to the touch position in pixels. These 4 values are:

| Value               | How to get them   |
|---------------------|---|
| GUI_TOUCH_AD_TOP    | Press the touch at the top and write down the analog input value in Y.    |
| GUI_TOUCH_AD_BOTTOM | Press the touch at the bottom and write down the analog input value in Y. |
| GUI_TOUCH_AD_LEFT   | Press the touch at the left and write down the analog input value in X.   |
| GUI_TOUCH_AD_RIGHT  | Press the touch at the right and write down the analog input value in X.  |

The example folder of emWin contains a small program which can be used to get these values from your touch panel. It is located in the folder Sample\Tutorial and its name is TOUCH\_Sample.c. Run this example on your hardware. The output should be similar to the screenshot at the right side.

```

Measurement of
A/D converter values
Analog input:
x:0423, y:0386
Position:
x:0093, y:0043

```



### Use GUI\_TOUCH\_Calibrate() with the above values

The last step is adding a call to `GUI_TOUCH_Calibrate()` using the calibration values. The recommended location for calibrating the touch screen is the initialization routine `LCD_X_Config()` which is located in `LCDConf.c`. similar to following example:

```

#define GUI_TOUCH_AD_TOP      877
#define GUI_TOUCH_AD_BOTTOM  273
#define GUI_TOUCH_AD_LEFT    232
#define GUI_TOUCH_AD_RIGHT   918
.
.
.
void LCD_X_Config(void) {
    //
    // Initialize display driver
    //
    .
    .
    .
    //
    // Set orientation of touch screen (only required when using
    //
    TouchOrientation = (GUI_MIRROR_X * LCD_GetMirrorX()) |
                       (GUI_MIRROR_Y * LCD_GetMirrorY()) |
                       (GUI_SWAP_XY * LCD_GetSwapXY())    ;
    GUI_TOUCH_SetOrientation(TouchOrientation);
    //
    // Calibrate touch screen
    //
    GUI_TOUCH_Calibrate(GUI_COORD_X, 0, 240, GUI_TOUCH_AD_TOP , GUI_TOUCH_AD_BOTTOM);
    GUI_TOUCH_Calibrate(GUI_COORD_Y, 0, 320, GUI_TOUCH_AD_LEFT, GUI_TOUCH_AD_RIGHT);
}

```

#### 5.9.4.2.2 Runtime calibration

In practice the exact values for the configuration file can be determined only for one touch panel. Because there are small differences between the parts of a series it could be very useful to calibrate each device at run-time. This can be done by using the function `GUI_TOUCH_Calibrate()`. The `Sample` folder contains the example `TOUCH_Calibrate.c` which shows, how a touch screen can be calibrated at run time:



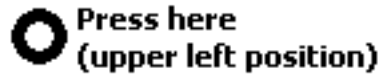

**Runtime calibration,  
please touch the screen  
at the center of the ring.**

### 5.9.4.2.3 Hardware routines

The following four hardware-dependent functions need to be added to your project if you use the driver supplied with emWin, as they are called by `GUI_TOUCH_Exec()` when polling the touch-panel. A suggested place is in the file `GUI_X.c`. These functions are as follows:

| Routine                              | Description                                |
|--------------------------------------|--|
| <code>GUI_TOUCH_X_ActivateX()</code> | Prepares measurement for Y-axis.           |
| <code>GUI_TOUCH_X_ActivateY()</code> | Prepares measurement for X-axis.           |
| <code>GUI_TOUCH_X_MeasureX()</code>  | Returns the X-result of the A/D converter. |
| <code>GUI_TOUCH_X_MeasureY()</code>  | Returns the Y-result of the A/D converter. |

#### 5.9.4.2.3.1 GUI\_TOUCH\_X\_ActivateX()

#### 5.9.4.2.3.2 GUI\_TOUCH\_X\_ActivateY()

##### Description

These routines are called from `GUI_TOUCH_Exec()` to activate the measurement of the X- and the Y-axes. `GUI_TOUCH_X_ActivateX()` switches on the measurement voltage to the X-axis; `GUI_TOUCH_X_ActivateY()` switches on the voltage to the Y- axis. Switching on the voltage in X means the value for the Y-axis can be measured and vice versa.

##### Prototypes

```
void GUI_TOUCH_X_ActivateX(void);
```

```
void GUI_TOUCH_X_ActivateY(void);
```

### 5.9.4.2.3.3 GUI\_TOUCH\_X\_MeasureX()

### 5.9.4.2.3.4 GUI\_TOUCH\_X\_MeasureY()

#### Description

These routines are called from GUI\_TOUCH\_Exec() to return the measurement values from the A/D converter for the X- and the Y-axes.

#### Prototypes

```
int GUI_TOUCH_X_MeasureX(void);
```

```
int GUI_TOUCH_X_MeasureY(void);
```

#### Example implementation

The following shows an example implementation of the touch hardware routines for a Renesas M16C/80 controller:

```
void GUI_TOUCH_X_ActivateX(void) {
    U8 Data;
    asm("fclr i"); /* Disable interrupts */
    Data = P10; /* Read port data */
    Data |= (1 << 2) | (1 << 3); /* Switch on power in X
                                and enable measurement in Y */
    Data &= ~(1 << 4) | (1 << 5); /* Switch off power in Y
                                and disable measurement in X */
    P10 = Data; /* Write port data */
    asm("fset i"); /* Enable interrupts */
}
void GUI_TOUCH_X_ActivateY(void) {
    U8 Data;
    asm("fclr i"); /* Disable interrupts */
    Data = P10; /* Read port data */
    Data |= (1 << 5) | (1 << 4); /* Switch on power in Y
                                and enable measurement in X */
    Data &= ~(1 << 3) | (1 << 2); /* Switch off power in X
                                and disable measurement in Y */
    P10 = Data; /* Write port data */
    asm("fset i"); /* Enable interrupts */
}
static void ReadADCx(int channel) {
    ADCON0 = channel /* Select channel 0-7 */
            | (0 << 3) /* One shot mode */
            | (0 << 6) /* A-D conversion start (0=stop) */
            | (0 << 7); /* FAD/4 select */
    ADCON1 = (0 << 0) /* A-D sweep select (XX) */
            | (0 << 2) /* No sweep mode */
            | (0 << 3) /* 8 bit mode */
            | (0 << 4) /* FAD4 select */
            | (1 << 5) /* VRef connected */
            | (0 << 6); /* Anex0/1 not used */
    ADCON2 = (1 << 0); /* Use example and hold */
    ADIC = 0; /* Reset IR flag */
    ADCON0 |= (1 << 6); /* Start conversion */
    while ((ADIC & (1 << 3)) == 0); /* Wait for end of conversion */
    ADCON0 &= ~(6 << 0); /* Start conversion = 0 */
}
int GUI_TOUCH_X_MeasureX(void) {
    ReadADCx(0);
    return AD0;
}
int GUI_TOUCH_X_MeasureY(void) {
    ReadADCx(1);
    return AD1;
}
```

```
}
```

#### 5.9.4.2.4 Driver API for analog touch screens

The table below lists the available analog touch screen driver routines in alphabetical order. These functions only apply if you are using the driver included with emWin.

| <b>Routine</b>                          | <b>Description</b>  |
|---|---|
| <code>GUI_TOUCH_Calibrate()</code>      | Changes the calibration at runtime.   |
| <code>GUI_TOUCH_Exec()</code>           | Polls the touch-screen by calling the <code>TOUCH_X</code> routines to activate the measurement of the X- and Y-axes. |
| <code>GUI_TOUCH_GetxPhys()</code>       | Returns a measurement value of the x-coordinate given from the A/D-converter.   |
| <code>GUI_TOUCH_GetyPhys()</code>       | Returns a measurement value of the y-coordinate given from the A/D-converter.   |
| <code>GUI_TOUCH_SetOrientation()</code> | The function configures the touch screen orientation.   |

#### 5.9.4.2.4.1 GUI\_TOUCH\_Calibrate()

##### Description

Changes the calibration at runtime.

##### Prototype

```
int GUI_TOUCH_Calibrate(int Coord,  
                        int Log0,  
                        int Log1,  
                        int Phys0,  
                        int Phys1);
```

##### Parameters

| Parameter             | Description                                     |
|-----------------------|---|
| <a href="#">Coord</a> | GUI_COORD_X for X-axis, GUI_COORD_Y for Y-axis. |
| <a href="#">Log0</a>  | Logical value 0 in pixels.                      |
| <a href="#">Log1</a>  | Logical value 1 in pixels.                      |
| <a href="#">Phys0</a> | A/D converter value for <a href="#">Log0</a> .  |
| <a href="#">Phys1</a> | A/D converter value for <a href="#">Log1</a> .  |

##### Additional information

The function takes as parameters the axis to be calibrated, two logical values in pixels for this axis and two corresponding physical values of the A/D converter. Since the logical value [Log0](#) usually is set to 0, [Log1](#) should contain the (x- or y-)size decreased by 1.

#### 5.9.4.2.4.2 GUI\_TOUCH\_Exec()

##### Description

Polls the touch-screen by calling the TOUCH\_X routines to activate the measurement of the X- and Y-axes. It is required that this function is called for about 100 times per second, since there is only one axis measured per call. Therefore a complete measurement of the touch screen is done with 2 calls of GUI\_TOUCH\_Exec().

##### Prototype

```
void GUI_TOUCH_Exec(void);
```

##### Additional information

If you are using a real-time operating system, the easiest way to make sure this function is called is to create a separate task. When not using a multitask system, you can use an interrupt service routine to do the job. This function calls GUI\_TOUCH\_StoreState().

#### 5.9.4.2.4.3 GUI\_TOUCH\_GetxPhys()

#### 5.9.4.2.4.4 GUI\_TOUCH\_GetyPhys()

##### Description

Returns a measurement value of the x- or y-coordinate given from the A/D-converter.

##### Prototype

```
int GUI_TOUCH_GetyPhys(void);
```

##### Return value

Measurement value of the x- or y-coordinate.

##### Additional information

A sample which shows how to use these functions is located in the folder `Sample\Tutorial` with the name `TOUCH_Sample.c`. Run this example on your hardware.



#### 5.9.4.2.4.5 GUI\_TOUCH\_SetOrientation()

##### Description

The function configures the touch screen orientation. If the touch screen for example already has been configured to work with the default orientation and the display now needs to be turned or mirrored, this function can be used to configure the touch driver to use the same orientation as the display without changing anything at the hardware routines.

##### Prototype

```
void GUI_TOUCH_SetOrientation(unsigned Orientation);
```

##### Parameters

| Parameter                   | Description   |
|-----------------------------|---|
| <a href="#">Orientation</a> | One or more "OR"-combined values of the values to be found under <i>Orientation flags</i> on page 2956. |

##### Additional information

Please note that this function has no effect when passing touch in-out to emWin by using the functions `GUI_PID_StoreState()`, `GUI_TOUCH_StoreState()` and `GUI_TOUCH_StoreStateEx()`.

### 5.9.4.2.5 Configuring the analog touch-screen driver

The touch screen driver is completely run-time configurable.

GUI\_TOUCH\_Calibrate() should be used to specify the physical values returned by the A/D converter for 2 positions per axis. If the display needs to be turned or mirrored, GUI\_TOUCH\_SetOrientation() can be used to set a new orientation without changing anything at the hardware routines.

Configuring the touch screen should be done before emWin manages any touch input.

#### Example

```
#define TOUCH_AD_LEFT 0x3c0
#define TOUCH_AD_RIGHT 0x034
#define TOUCH_AD_TOP 0x3b0
#define TOUCH_AD_BOTTOM 0x034
Orientation = (GUI_MIRROR_X * LCD_GetMirrorXEx(0)) |
              (GUI_MIRROR_Y * LCD_GetMirrorYEx(0)) |
              (GUI_SWAP_XY * LCD_GetSwapXYEx (0)) ;
GUI_TOUCH_SetOrientation(Orientation);
GUI_TOUCH_Calibrate(GUI_COORD_X, 0, 319, TOUCH_AD_LEFT, TOUCH_AD_RIGHT);
GUI_TOUCH_Calibrate(GUI_COORD_Y, 0, 239, TOUCH_AD_TOP, TOUCH_AD_BOTTOM);
```

### 5.9.5 Touch screen calibration

Normally a touch screen is mounted over the display. That means the data measured by the touch screen need to be translated into pixel coordinates of the display. To be able to do that transformation, the calibration algorithm needs to calculate transformation coefficients first. That can be done with a different number of points. The more points are available for coefficient calculation, the better the result. If rotation should be considered, at least 3 points are required for coefficient calculation.

#### 2-Point Calibration

The classical calibration algorithm of emWin uses 2-point calibration. That means the calibration is done by passing 2 reference points (pixel coordinates) and 2 sample values (measurement results) for each axis to the calibration routine. Normally those points are near to the min- and max-values of each axis. The resulting calibration coefficients of a 2-point-calibration do not consider rotation. Only scaling and transformation could be considered. The following diagram shows the recommended position of the points to be used:

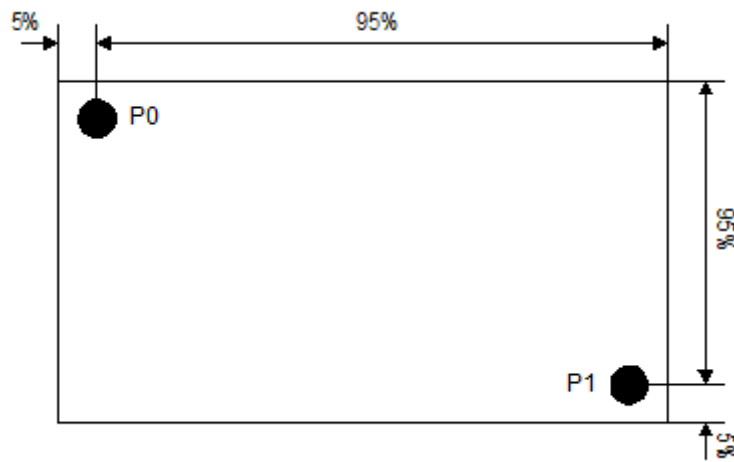

#### 3-Point Calibration

A third calibration point makes it possible to consider scaling, transformation and rotation between reference- and sample values. The following diagram shows the recommended position of the points to be used:

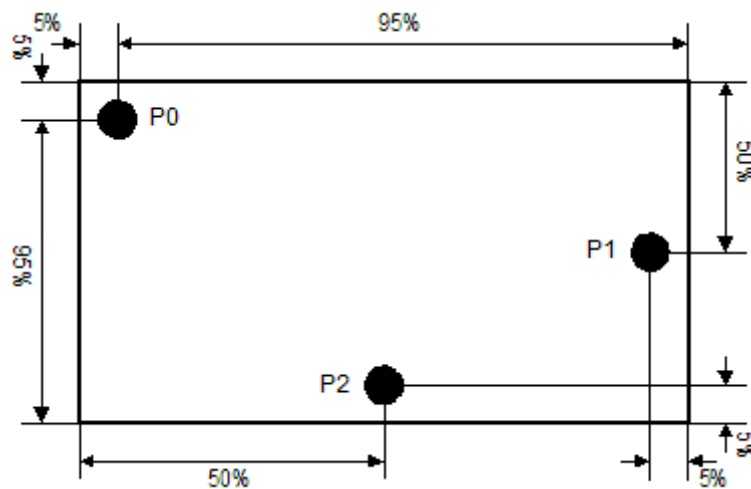

#### N-Point Calibration

The more points are available, the better is the result of coefficient calculation. The following diagrams show the recommended positions for a 5- and a 9-point calibration:

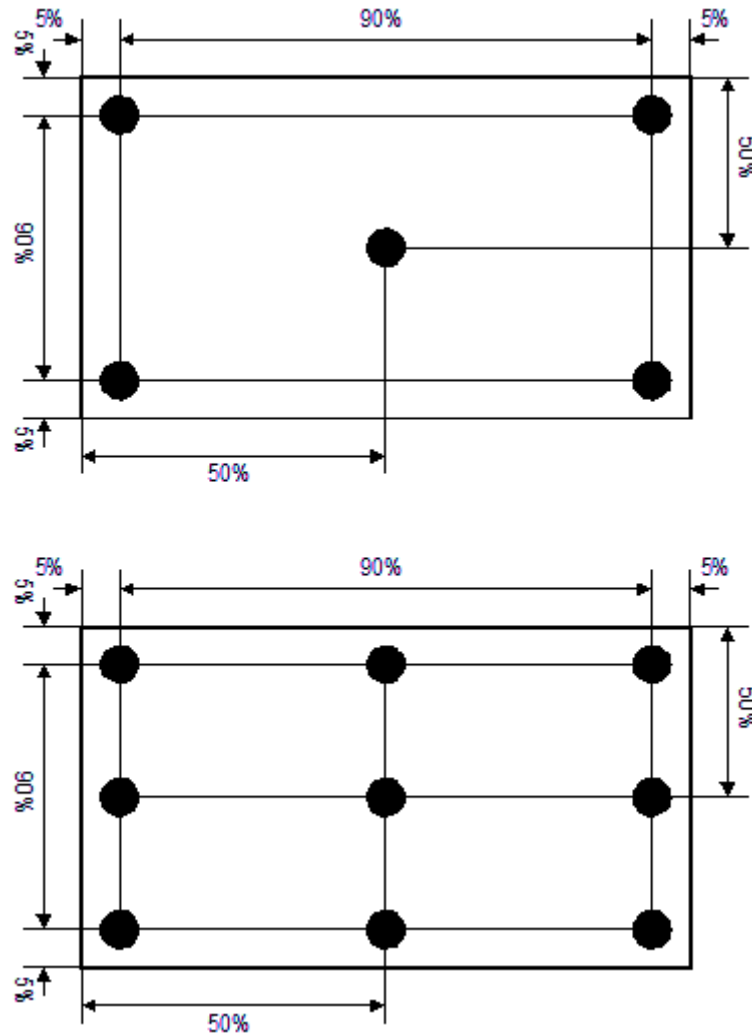

### 5.9.5.1 Using calibration with the analog touch screen driver

The analog touch screen driver shipped with emWin automatically uses the touch screen calibration routines. To be able to use it the calibration has to be initialized by calculating the calibration coefficients. That could be done by calling `GUI_TOUCH_Calibrate()` explained in chapter *The analog touch screen driver* on page 690 for a 2-point calibration. If 3 or more points should be used the function `GUI_TOUCH_CalcCoefficients()` should be called.

### 5.9.5.2 Using calibration with a custom touch screen driver

If there is an already existing a touch screen driver available and the internal analog touch screen driver of emWin is not used, the way of using the calibration routines is different. The most simple way is calling `GUI_TOUCH_CalcCoefficients()` for coefficient calculation. The second step is calling `GUI_TOUCH_EnableCalibration()`. That makes sure, that all touch events will be calibrated automatically before they are stored into the PID-buffer of emWin. It is also possible to use the calibration API functions by the application before an event is stored into the PID buffer.

### 5.9.5.3 Calibration API

The table below lists the available calibration routines in alphabetical order.

| Routine                                    | Description  |
|--|--|
| <code>GUI_TOUCH_CalcCoefficients()</code>  | This routine is required for initializing the process of calibration.  |
| <code>GUI_TOUCH_CalibratePoint()</code>    | The function converts the given sample point into screen coordinates in pixels and checks if the given values are within the display area. |
| <code>GUI_TOUCH_EnableCalibration()</code> | This function may be used if the calibration routines should be used with a custom touch screen driver.                                    |
| <code>GUI_TOUCH_TransformPoint()</code>    | Calibrates the given point without any check.  |

### 5.9.5.3.1 GUI\_TOUCH\_CalcCoefficients()

#### Description

This routine is required for initializing the process of calibration. To be able to calibrate a point via `GUI_TOUCH_CalibratePoint()` or `GUI_TOUCH_TransformPoint()` coefficient values are required for transforming the given values into pixel coordinates. These coefficients are calculated by the given reference values and the according sample values passed to this routine. As explained at the beginning of this subchapter coefficient calculation can be done with at least 2 points. To achieve the best possible result it is recommended to use 3 or more points.

#### Prototype

```
int GUI_TOUCH_CalcCoefficients(int    NumPoints,
                              int * pxRef,
                              int * pyRef,
                              int * pxSample,
                              int * pySample,
                              int    xSize,
                              int    ySize);
```

#### Parameters

| Parameter              | Description   |
|------------------------|---|
| <code>NumPoints</code> | Number of points used for calculating the calibration coefficients. |
| <code>pxRef</code>     | Pointer to an array of reference values for X-axis.                 |
| <code>pyRef</code>     | Pointer to an array of reference values for Y-axis.                 |
| <code>pxSample</code>  | Pointer to an array of sample values for X-axis.                    |
| <code>pySample</code>  | Pointer to an array of sample values for Y-axis.                    |
| <code>xSize</code>     | X-size in pixels of the touch screen.                               |
| <code>ySize</code>     | Y-size in pixels of the touch screen.                               |

#### Return value

0        on success.  
1        on error.

### 5.9.5.3.2 GUI\_TOUCH\_CalibratePoint()

#### Description

The function converts the given sample point into screen coordinates in pixels and checks if the given values are within the display area. If not an error is returned.

#### Prototype

```
int GUI_TOUCH_CalibratePoint(int * px,  
                             int * py);
```

#### Parameters

| Parameter       | Description                                   |
|-----------------|---|
| <code>px</code> | Pointer to a sample coordinate of the X-axis. |
| <code>py</code> | Pointer to a sample coordinate of the Y-axis. |

#### Return value

0        on success  
1        on error.

#### Additional information

Coefficients need to be calculated first.

### 5.9.5.3.3 GUI\_TOUCH\_EnableCalibration()

#### Description

This function may be used if the calibration routines should be used with a custom touch screen driver. When using a custom touch screen driver normally `GUI_TOUCH_StoreState()` or `GUI_TOUCH_StoreStateEx()` is used for putting touch events into the PID-buffer of emWin. The default behavior of emWin is storing the coordinates into the buffer without calibration. If enabled each coordinate will be calibrated before it is stored into the buffer.

#### Prototype

```
void GUI_TOUCH_EnableCalibration(int OnOff);
```

#### Parameters

| Parameter          | Description  |
|--------------------|--|
| <code>OnOff</code> | 1 for enabling calibration, 0 for disabling (default). |

#### Additional information

When using the analog touch screen driver of emWin this function is not required.



### 5.9.5.3.4 GUI\_TOUCH\_TransformPoint()

#### Description

Calibrates the given point without any check.

#### Prototype

```
int GUI_TOUCH_TransformPoint(int * px,  
                             int * py);
```

#### Parameters

| Parameter       | Description                                   |
|-----------------|---|
| <code>px</code> | Pointer to a sample coordinate of the X-axis. |
| <code>py</code> | Pointer to a sample coordinate of the Y-axis. |

#### Return value

0        on success  
1        on error.

#### Additional information

Coefficients need to be calculated first.

## 5.9.6 Joystick input example

The following example shows how the pointer input device API can be used to process the input from a joystick:

```

/*****
 *
 *      _JoystickTask
 *
 * Purpose:
 * Periodically read the Joystick and inform emWin using
 * GUI_PID_StoreState.
 * It supports dynamic acceleration of the pointer.
 * The Joystick is a simple, standard 5 switch (digital) type.
 *
 */
static void _JoystickTask(void) {
    GUI_PID_STATE State;
    int Stat;
    int StatPrev = 0;
    int TimeAcc = 0;    // Dynamic acceleration value
    int xMax, yMax;

    xMax = LCD_GetXSize() - 1;
    yMax = LCD_GetYSize() - 1;
    while (1) {
        Stat = HW_ReadJoystick();
        //
        // Handle dynamic pointer acceleration
        //
        if (Stat == StatPrev) {
            if (TimeAcc < 10) {
                TimeAcc++;
            }
        } else {
            TimeAcc = 1;
        }
        if (Stat || (Stat != StatPrev)) {
            //
            // Compute the new coordinates
            //
            GUI_PID_GetState(&State);
            if (Stat & JOYSTICK_LEFT) {
                State.x -= TimeAcc;
            }
            if (Stat & JOYSTICK_RIGHT) {
                State.x += TimeAcc;
            }
            if (Stat & JOYSTICK_UP) {
                State.y -= TimeAcc;
            }
            if (Stat & JOYSTICK_DOWN) {
                State.y += TimeAcc;
            }
            //
            // Make sure coordinates are still in bounds
            //
            if (State.x < 0) {
                State.x = 0;
            }
            if (State.y < 0) {
                State.y = 0;
            }
            if (State.x >= xMax) {
                State.x = xMax;
            }
            if (State.y > yMax) {

```

```
    State.y = yMax;
}
//
// Inform emWin
//
State.Pressed = (Stat & JOYSTICK_ENTER) ? 1: 0;
GUI_PID_StoreState(&State);
StatPrev = Stat;
}
OS_Delay(40);
}
}
```

## 5.10 Multiple Buffering

Multiple Buffering is a method of using more than one frame buffer. Basically it works as follows: With multiple buffers enabled there is a front buffer which is used by the display controller to generate the picture on the screen and one or more back buffers which are used for the drawing operations. After completing the drawing operations the back buffer becomes the visible front buffer.

With two buffers, one front and one back buffer, it is normally called "double buffering", with two back buffers and one front buffer it is called "triple buffering".

In general it is a method which is able to avoid several unwanted effects:

- The visible process of drawing a screen item by item
- Flickering effects caused by overlapping drawing operations
- Tearing effects caused by writing operations outside the vertical blanking period

The following section explains in detail how it works, the requirements to be able to use this feature, how to configure emWin and the advantage of "triple buffering" against "double buffering". Further it explains how to configure the optional Window Manager for automatic use of Multiple Buffering.

### 5.10.1 How it works

Multiple Buffering is the use of more than one frame buffer, so that the display ever shows a screen which is already completely rendered, even if a drawing operation is in process. When starting the process of drawing the current content of the front buffer is copied into a back buffer. After that all drawing operations take effect only on this back buffer. After the drawing operation has been completed the back buffer becomes the front buffer. Making the back buffer the visible front buffer normally only requires the modification of the frame buffer start address register of the display controller.

Now it should be considered that a display is being refreshed continuously by the display controller approximately 60 times per second. After each period there is a vertical synchronization signal, normally known as VSYNC signal. The best moment to make the back buffer the new front buffer is this signal. If not considering the VSYNC signal tearing effects can occur.

#### Tearing effect



### 5.10.1.1 Double Buffering

With double buffering only 2 buffers are available: One front and one back buffer. When starting the drawing operation the current content of the front buffer is copied into the back buffer. After completing the operation the back buffer should become the visible front buffer.

As explained above the best moment for doing this is reacting on the VSYNC signal of the display controller. Here the disadvantage of double buffering against triple buffering is revealed: Either the frame buffer start address is changed immediately at the end of the drawing operation or after waiting until the next VSYNC signal. This means that either tearing effects could occur or the performance slows down because of waiting for the next VSYNC signal.

### 5.10.1.2 Triple Buffering

As the name implies there are 3 buffers available: One front and 2 back buffers. When starting the drawing operation the current content of the front buffer is copied into the first back buffer. After completing the operation the back buffer should become the visible front buffer. Contrary to the double buffer solution it is not required to switch to the buffer immediately. Switching to the new front buffer could be done on the next VSYNC signal of the display controller which can be achieved by an interrupt service routine (ISR). Most of the display controllers which are able to deal with more than one frame buffer provide the VSYNC signal as interrupt source. Within the ISR the pending front buffer should become visible. Until the pending front buffer becomes visible it is not used for further drawing operations. If a further drawing operation is initiated before the pending front buffer has become visible the second back buffer is used for the drawing operation. If a new buffer is ready until waiting for the VSYNC signal it becomes the new pending front buffer and so on. This always protects the front buffer against writing operations.

It should be mentioned that changing the display buffer start address on some display controllers only takes effect when drawing the next frame. In this case the solution without ISR works as well as with ISR. Only if changing the address takes effect directly an ISR is required to avoid tearing effects.

## 5.10.2 Requirements

The following list shows the requirements for using multiple buffers:

- The display controller should support multiple frame buffers.
- Enough video RAM for multiple frame buffers should be available.
- If tearing effects should be avoided it should be possible to react on the VSYNC signal of the display controller and triple buffering is recommended to achieve the best performance.

## 5.10.3 Limitations

Multiple Buffering can not be used with virtual screens.

## 5.10.4 Configuration

In general there are 2 routines in the configuration file `LCDCConf.c` which need to be modified, the display configuration routine `LCD_X_Config()` and the driver callback function `LCD_X_DisplayDriver()`.

### 5.10.4.1 LCD\_X\_Config()

Basically one thing needs to be done here: Enabling the use of multiple buffers.

#### Basic configuration

The first thing which has to be done before creating the display driver device is configuring the multiple buffer interface. This is normally done in `LCD_X_Config()`. It is strictly required to enable Multiple Buffering before creating the display driver device as shown in the following code snippet:

```
void LCD_X_Config(void) {
    //
    // Initialize MultiBuffering
    //
    GUI_MULTIBUF_Config(NUM_BUFFERS);
    //
    // Set display driver and color conversion
    //
    GUI_DEVICE_CreateAndLink(DISPLAY_DRIVER, COLOR_CONVERSION, 0, 0);
    ...
}
```

#### Callback routine for copying the buffers

Further a callback routine for copying the buffers can be set. As explained above at the beginning of the drawing operation it is required to copy the content of the current front buffer to the back buffer. Normally a simple `memcpy` operation is used to do this. But if the used display controller for example consists of a BitBLT-engine which is able to do the copy operation it could be desired to use it for the copy operation. Or a DMA based routine should be used to do the copy operation. In these cases a custom defined callback function can be used for this operation. It can be installed after creating the display driver device as shown in the following code snippet:

```
static void _CopyBuffer(int LayerIndex, int IndexSrc, int IndexDst) {
    unsigned long BufferSize, AddrSrc, AddrDst;

    //
    // Calculate the size of one frame buffer
    //
    BufferSize = (XSIZE * YSIZE * BITSPPERPIXEL) / 8;
    //
    // Calculate source- and destination address
    //
    AddrSrc = _VRamBaseAddr + BufferSize * IndexSrc;
    AddrDst = _VRamBaseAddr + BufferSize * IndexDst;
    memcpy((void *)AddrDst, (void *)AddrSrc, BufferSize);
}

void LCD_X_Config(void) {
    //
    // Initialize multibuffering
    //
    GUI_MULTIBUF_Config(NUM_BUFFERS);
    //
    // Set display driver and color conversion
    //
    GUI_DEVICE_CreateAndLink(DISPLAY_DRIVER, COLOR_CONVERSION, 0, 0);
    //
    // Set custom callback function for copy operation
}
```

```
//
LCD_SetDevFunc(0, LCD_DEVFUNC_COPYBUFFER, (void (*)())_CopyBuffer);
}
```

The above sample implementation makes no sense, because the simple call of `memcpy()` equals the default behavior of the display driver. It makes only sense to use a custom copy buffer function if there is any possibility to accelerate the copy operation.

### Buffers in non-consecutive RAM areas

If the RAM on a device is not large enough to hold all buffers used for multiple buffering consecutively, it is possible to pass multiple RAM addresses to `emWin`. By calling `LCD_SetBufferPtr()` it is possible to tell `emWin` the addresses of every single buffer location.

```
static const U32 _aBufferPTR[] = {
    0x00000100, // Begin of On-Chip RAM
    0x00800000 // Begin of Expansion RAM
};
LCD_SetBufferPtrEx(0, (void **)_aBufferPTR);
```

#### 5.10.4.2 LCD\_X\_DisplayDriver()

After the drawing process has been completed the back buffer should become visible. The display driver sends a `LCD_X_SHOWBUFFER` command to the display driver callback function. The callback function then has to react on the command and should make sure that the buffer becomes visible. This can be done either by an ISR or by directly writing the right address into the frame buffer start address of the display controller.

#### With ISR

The following code snippet shows a sample implementation:

```
static void _ISR_EndOfFrame(void) {
    unsigned long Addr, BufferSize;
    if (_PendingBuffer >= 0) {
        //
        // Calculate address of the given buffer
        //
        BufferSize = (XSIZE * YSIZE * BITSPERPIXEL) / 8;
        Addr      = _VRamBaseAddr + BufferSize * _PendingBuffer;
        //
        // Tell LCD controller the new frame buffer address
        //
        AT91C_LCDC_BA1 = Addr;
        //
        // Send a confirmation that the buffer is visible now
        //
        GUI_MULTIBUF_Confirm(_PendingBuffer);
        _PendingBuffer = -1;
    }
}

int LCD_X_DisplayDriver(unsigned LayerIndex, unsigned Cmd, void * p) {
    LCD_X_SHOWBUFFER_INFO * pData;
    switch (Cmd) {
        ...
        case LCD_X_SHOWBUFFER:
            pData = (LCD_X_SHOWBUFFER_INFO *)p;
            //
            // Remember buffer index to be used by ISR
            //
            _PendingBuffer = pData->Index;
            break;
    }
}
```

The above implementation assumes the existence of an ISR which is executed at the next VSYNC signal.

### Without ISR

If there is no ISR available alternatively the address can be set directly with the disadvantage that tearing effects could occur.

The following code snippet shows a sample implementation:

```
int LCD_X_DisplayDriver(unsigned LayerIndex, unsigned Cmd, void * p) {
    LCD_X_SHOWBUFFER_INFO * pData;
    unsigned long    BufferSize;
    unsigned long    Addr;
    switch (Cmd) {
        ...
        case LCD_X_SHOWBUFFER: {
            pData = (LCD_X_SHOWBUFFER_INFO *)p;
            //
            // Calculate address of the given buffer
            //
            BufferSize = (XSIZE * YSIZE * BITSPERPIXEL) / 8;
            Addr      = _VRamBaseAddr + BufferSize * pData->Index;
            //
            // Make the given buffer visible
            //
            AT91C_LCDC_BA1 = Addr;
            //
            // Send a confirmation that the buffer is visible now
            //
            GUI_MULTIBUF_Confirm(pData->Index);
            break;
        }
    }
}
```

## 5.10.5 Automatic use of multiple buffers with the WM

The optional Window Manager (WM) is able to use the multiple buffer feature automatically. The function `WM_MULTIBUF_Enable()` can be used to enable this function. If enabled the WM first switches to the back buffer before redrawing the invalid windows. After drawing all invalid windows the new screen becomes visible. This hides the process of drawing a screen window by window.



## 5.10.6 Multiple Buffering API

The following table lists the available routines of the multiple buffer support.

| Routine                                     | Description   |
|---|---|
| <code>GUI_MULTIBUF_Begin()</code>           | Needs to be called immediately before the drawing process.  |
| <code>GUI_MULTIBUF_BeginEx()</code>         | Needs to be called immediately before the drawing process in the given layer.   |
| <code>GUI_MULTIBUF_Config()</code>          | The function needs to be called during initialization in order to enable the use of Multiple Buffering.                     |
| <code>GUI_MULTIBUF_ConfigEx()</code>        | The function needs to be called during initialization in order to enable the use of Multiple Buffering for the given layer. |
| <code>GUI_MULTIBUF_Confirm()</code>         | This function needs to be called immediately after a new buffer has become visible.   |
| <code>GUI_MULTIBUF_ConfirmEx()</code>       | This function needs to be called immediately after a new buffer has become visible in the given layer.                      |
| <code>GUI_MULTIBUF_End()</code>             | This function needs to be called after the new screen has been completely drawn.  |
| <code>GUI_MULTIBUF_EndEx()</code>           | This function needs to be called after the new screen has been completely drawn for the given layer.                        |
| <code>GUI_MULTIBUF_GetNumBuffers()</code>   | The function returns the number of buffers configured.  |
| <code>GUI_MULTIBUF_GetNumBuffersEx()</code> | The function returns the number of buffers configured for the given layer.  |
| <code>GUI_MULTIBUF_UseSingleBuffer()</code> | Lets the multi buffering use one frame for all layers.  |

### 5.10.6.1 GUI\_MULTIBUF\_Begin()

#### Description

Needs to be called immediately before the drawing process.

#### Prototype

```
void GUI_MULTIBUF_Begin(void);
```

#### Additional information

This function makes sure that the current front buffer will be copied into the back buffer which then is used for all subsequent drawing operations. The copy operation is normally done by the display driver itself. As explained earlier this can also be achieved by a custom callback function.

### 5.10.6.2 GUI\_MULTIBUF\_BeginEx()

#### Description

Needs to be called immediately before the drawing process in the given layer.

#### Prototype

```
void GUI_MULTIBUF_BeginEx(int LayerIndex);
```

#### Parameters

| Parameter  | Description       |
|------------|-------------------|
| LayerIndex | Layer to be used. |

### 5.10.6.3 GUI\_MULTIBUF\_Config()

#### Description

The function needs to be called during initialization in order to enable the use of Multiple Buffering. This is done typically from within `LCD_X_Config()`.

#### Prototype

```
void GUI_MULTIBUF_Config(int NumBuffers);
```

#### Parameters

| Parameter               | Description   |
|-------------------------|---|
| <code>NumBuffers</code> | Number of buffers to be used. The following numbers are self-explanatory:<br>2 - Double buffering<br>3 - Triple buffering |

#### Additional information

The function needs to be called before creating the display driver device.

### 5.10.6.4 GUI\_MULTIBUF\_ConfigEx()

#### Description

The function needs to be called during initialization in order to enable the use of Multiple Buffering for the given layer. This is done typically from within `LCD_X_Config()`.

#### Prototype

```
void GUI_MULTIBUF_ConfigEx(int LayerIndex,  
                           int NumBuffers);
```

#### Parameters

| Parameter               | Description   |
|-------------------------|---|
| <code>LayerIndex</code> | Layer to be used.   |
| <code>NumBuffers</code> | Number of buffers to be used. The following numbers are self-explanatory:<br>2 - Double buffering<br>3 - Triple buffering |

### 5.10.6.5 GUI\_MULTIBUF\_Confirm()

#### Description

This function needs to be called immediately after a new buffer has become visible.

#### Prototype

```
void GUI_MULTIBUF_Confirm(int BufferIndex);
```

#### Parameters

| Parameter             | Description  |
|-----------------------|--|
| <a href="#">Index</a> | <a href="#">Index</a> of buffer which has been made visible. |

#### Additional information

The function is typically called by the ISR which switches to the new front buffer or by the display driver callback function.

### 5.10.6.6 GUI\_MULTIBUF\_ConfirmEx()

#### Description

This function needs to be called immediately after a new buffer has become visible in the given layer.

#### Prototype

```
void GUI_MULTIBUF_ConfirmEx(int LayerIndex,  
                             int BufferIndex);
```

#### Parameters

| Parameter                  | Description  |
|----------------------------|--|
| <a href="#">LayerIndex</a> | Layer to be used.  |
| <a href="#">Index</a>      | <a href="#">Index</a> of buffer which has been made visible. |

### 5.10.6.7 GUI\_MULTIBUF\_End()

#### Description

This function needs to be called after the new screen has been completely drawn.

#### Prototype

```
void GUI_MULTIBUF_End(void);
```

#### Additional information

When calling this function the display driver sends an `LCD_X_SHOWBUFFER` command to the display driver callback routine which then has to make the given buffer the front buffer.



### 5.10.6.8 GUI\_MULTIBUF\_EndEx()

#### Description

This function needs to be called after the new screen has been completely drawn for the given layer.

#### Prototype

```
void GUI_MULTIBUF_EndEx(int LayerIndex);
```

#### Parameters

| Parameter               | Description       |
|-------------------------|-------------------|
| <code>LayerIndex</code> | Layer to be used. |

### 5.10.6.9 GUI\_MULTIBUF\_GetNumBuffers()

#### Description

The function returns the number of buffers configured.

#### Prototype

```
int GUI_MULTIBUF_GetNumBuffers(void);
```

#### Return value

The number of buffers configured for the current layer.

### 5.10.6.10 GUI\_MULTIBUF\_GetNumBuffersEx()

#### Description

The function returns the number of buffers configured for the given layer.

#### Prototype

```
int GUI_MULTIBUF_GetNumBuffersEx(int LayerIndex);
```

#### Parameters

| Parameter  | Description       |
|------------|-------------------|
| LayerIndex | Layer to be used. |

#### Return value

The number of buffers configured for the specified layer.

### 5.10.6.11 GUI\_MULTIBUF\_UseSingleBuffer()

#### Description

Lets the multi buffering use one frame for all layers.

#### Prototype

```
void GUI_MULTIBUF_UseSingleBuffer(void);
```

#### Additional information

The function needs to be called before creating the display driver device.

## 5.11 Keyboard Input

emWin provides support for any kind of keyboards. Any type of keyboard driver is compatible with emWin.

The software for keyboard input is located in the subdirectory `GUI\Core` and part of the basic package.

### 5.11.1 Description

A keyboard input device uses ASCII character coding in order to be able to distinguish between characters. For example, there is only one "A" key on the keyboard, but an uppercase "A" and a lowercase "a" have different ASCII codes (0x41 and 0x61, respectively).

#### emWin predefined character codes

emWin also defines character codes for other "virtual" keyboard operations. These codes are listed in the table below, and defined in an identifier table in `GUI.h`. A character code in emWin can therefore be any extended ASCII character value or any of the following predefined emWin values.

| Predefined virtual key code    | Description                                   |
|--------------------------------|---|
| <code>GUI_KEY_BACKSPACE</code> | Backspace key.                                |
| <code>GUI_KEY_TAB</code>       | Tab key.                                      |
| <code>GUI_KEY_BACKTAB</code>   | Shift + Tab key.                              |
| <code>GUI_KEY_ENTER</code>     | Enter/return key.                             |
| <code>GUI_KEY_LEFT</code>      | Left arrow key.                               |
| <code>GUI_KEY_UP</code>        | Up arrow key.                                 |
| <code>GUI_KEY_RIGHT</code>     | Right arrow key.                              |
| <code>GUI_KEY_DOWN</code>      | Down arrow key.                               |
| <code>GUI_KEY_HOME</code>      | Home key (move to beginning of current line). |
| <code>GUI_KEY_END</code>       | End key (move to end of current line).        |
| <code>GUI_KEY_SHIFT</code>     | Shift key.                                    |
| <code>GUI_KEY_CONTROL</code>   | Control key.                                  |
| <code>GUI_KEY_ESCAPE</code>    | Escape key.                                   |
| <code>GUI_KEY_INSERT</code>    | Insert key.                                   |
| <code>GUI_KEY_DELETE</code>    | Delete key.                                   |
| <code>GUI_KEY_SPACE</code>     | Space key.                                    |
| <code>GUI_KEY_PGUP</code>      | Page up key.                                  |
| <code>GUI_KEY_PGDOWN</code>    | Page down key.                                |

### 5.11.2 Driver layer API

The keyboard driver layer handles keyboard messaging functions. These routines notify the Window Manager when specific keys (or combinations of keys) have been pressed or released. The table below lists the driver-layer keyboard routines in alphabetical order. Detailed descriptions follow.

| Routine                        | Description   |
|--------------------------------|---|
| <code>GUI_StoreKeyMsg()</code> | Stores a key message in the keyboard buffer.            |
| <code>GUI_SendKeyMsg()</code>  | Sends a key message to the window with the input focus. |

### 5.11.2.1 GUI\_StoreKeyMsg()

#### Description

Stores a key message in the keyboard buffer.

#### Prototype

```
void GUI_StoreKeyMsg(int Key,  
                    int PressedCnt);
```

#### Parameters

| Parameter               | Description   |
|-------------------------|---|
| <a href="#">Key</a>     | May be any extended ASCII character (between 0x20 and 0xFF) or any predefined emWin character code. |
| <a href="#">Pressed</a> | <a href="#">Key</a> state. 1 for pressed state, 0 for released (unpressed) state.                   |

#### Additional information

This function can be used from an interrupt service routine. The keyboard input manager of emWin contains a FIFO buffer which is able to hold up to 10 keyboard events per default. If a different size is required this value can be changed. Details can be found in the section *Advanced GUI configuration options* on page 129.

The Window Manager polls the keyboard buffer automatically and sends according keyboard messages to the currently focussed window.

### 5.11.2.2 GUI\_SendKeyMsg()

#### Description

Sends a key message to the window with the input focus. If no window has the input focus, the function `GUI_StoreKeyMsg()` is called to store the data to the input buffer.

#### Prototype

```
void GUI_SendKeyMsg(int Key,  
                  int PressedCnt);
```

#### Parameters

| Parameter            | Description   |
|----------------------|---|
| <code>Key</code>     | May be any extended ASCII character (between 0x20 and 0xFF) or any predefined emWin character code. |
| <code>Pressed</code> | <code>Key</code> state (see <code>GUI_StoreKeyMsg()</code> ).                                       |

#### Additional information

This function should not be called from an interrupt service routine.

### 5.11.3 Application layer API

The table below lists the application-layer keyboard routines in alphabetical order. Detailed descriptions follow.

| <b>Routine</b>                    | <b>Description</b>                             |
|-----------------------------------|--|
| <code>GUI_ClearKeyBuffer()</code> | Clears the key buffer.                         |
| <code>GUI_GetKey()</code>         | Returns the current content of the key buffer. |
| <code>GUI_GetKeyState()</code>    | Returns the current key state.                 |
| <code>GUI_StoreKey()</code>       | Stores a key in the buffer.                    |
| <code>GUI_WaitKey()</code>        | Waits for a key to be pressed.                 |



### 5.11.3.1 GUI\_ClearKeyBuffer()

#### Description

Clears the key buffer.

#### Prototype

```
void GUI_ClearKeyBuffer(void);
```

### 5.11.3.2 GUI\_GetKey()

#### Description

Returns the current content of the key buffer.

#### Prototype

```
int GUI_GetKey(void);
```

#### Return value

Codes of characters in the key buffer; 0 if no key is buffered.

### 5.11.3.3 GUI\_GetKeyState()

#### Description

Returns the current key state.

#### Prototype

```
void GUI_GetKeyState(GUI_KEY_STATE * pState);
```

#### Parameters

| Parameter           | Description  |
|---------------------|--|
| <code>pState</code> | Pointer to structure of type <code>GUI_KEY_STATE</code> which is filled by the function. |

### 5.11.3.4 GUI\_StoreKey()

#### Description

Stores a key in the buffer.

#### Prototype

```
void GUI_StoreKey(int Key);
```

#### Parameters

| Parameter | Description   |
|-----------|---|
| Key       | May be any extended ASCII character (between 0x20 and 0xFF) or any predefined emWin character code. |

#### Additional information

This function is typically called by the driver and not by the application itself.

### 5.11.3.5 GUI\_WaitKey()

#### Description

Waits for a key to be pressed.

#### Prototype

```
int GUI_WaitKey(void);
```

#### Return value

The pressed key.

#### Additional information

The application is “blocked”, meaning it will not return until a key is pressed.

## 5.11.4 Data structure

### 5.11.4.1 GUI\_KEY\_STATE

#### Description

Data structure used to store a key state.

#### Type definition

```
typedef struct {  
    int Key;  
    int Pressed;  
} GUI_KEY_STATE;
```

#### Structure members

| Member                  | Description   |
|-------------------------|---|
| <a href="#">Key</a>     | <a href="#">Key</a> code.   |
| <a href="#">Pressed</a> | 1, if the key is pressed.<br>0, if the key is not pressed.<br>-1, if the state could not be determined. |

## 5.12 Language Support

Text written in a language like Arabic, Thai or Chinese contains characters, which are normally not part of the fonts shipped with emWin. This chapter explains the basics like the Unicode standard, which defines all available characters worldwide and the UTF-8 encoding scheme, which is used by emWin to decode text with Unicode characters. It also explains how to enable bidirectional (and right to left) text support to be able to render Arabic or Hebrew scripts. A further subchapter explains how to render text with Shift-JIS (Japanese Industry Standard) encoding.

### 5.12.1 Unicode

Unicode is an international standard defined by the Unicode consortium. For each meaningful character or text element of all known cultures it contains a unique digital code point. Further it contains the bidirectional algorithm for right-to-left scripts like Hebrew and Arabic, which are also supported by emWin.

The Unicode Standard defines a codespace of 1,114,112 code points in the range from 0 to 0x10FFFF containing a repertoire of more than 128,000 characters covering more than 135 scripts. This codespace is divided into seventeen planes, numbered 0 to 16. emWin supports the complete *Basic Multilingual Plane* (BMP, plane 0) which covers the code points from 0x0000 to 0xFFFF. This BMP contains characters for almost all modern languages, and a large number of special characters. Characters outside the BMP are currently not supported.

#### 5.12.1.1 UTF-8 encoding

ISO/IEC 10646-1 defines a multi-octet character set called the Universal Character Set (UCS) which encompasses most of the world's writing systems. Multi-octet characters, however, are not compatible with many current applications and protocols, and this has led to the development of a few UCS transformation formats (UTF), each with different characteristics.

UTF-8 has the characteristic of preserving the full ASCII range, providing compatibility with file systems, parsers and other software that rely on ASCII values but are transparent to other values.

In emWin, UTF-8 characters are encoded using sequences of 1 to 3 octets. If the high-order bit is set to 0, the remaining 7 bits being used to encode the character value. In a sequence of  $n$  octets,  $n > 1$ , the initial octet has the  $n$  higher-order bits set to 1, followed by a bit set to 0. The remaining bit(s) of that octet contain bits from the value of the character to be encoded. The following octet(s) all have the higher-order bit set to 1 and the following bit set to 0, leaving 6 bits in each to contain bits from the character to be encoded.

The following table shows the encoding ranges:

| Character range | UTF-8 Octet sequence       |
|-----------------|----------------------------|
| 0000 - 007F     | 0xxxxxxxx                  |
| 0080 - 07FF     | 110xxxxx 10xxxxxx          |
| 0800 - FFFF     | 1110xxxx 10xxxxxx 10xxxxxx |

#### Encoding example

The text "Halöle" contains ASCII characters and European extensions. The following hex dump shows this text as UTF-8 encoded text:

```
48 61 6C C3 B6 6C 65
```

#### Programming examples

If we want to display a text containing non-ASCII characters, we can do this by manually computing the UTF-8 codes for the non-ASCII characters in the string. However, if

your compiler supports UTF-8 encoding (Sometimes called multi-byte encoding), even non-ASCII characters can be used directly in strings.

```
//
// Example using ASCII encoding:
//
GUI_UC_SetEncodeUTF8();      /* required only once to activate UTF-8*/
GUI_DispString("Hal\xc3\xb6le");
//
// Example using UTF-8 encoding:
//
GUI_UC_SetEncodeUTF8();      /* required only once to activate UTF-8*/
GUI_DispString("Halöle");
```

### 5.12.1.2 Unicode characters

The character output routine used by emWin (`GUI_DispChar()`) does always take an unsigned 16-bit value (U16) and has the basic ability to display a character defined by Unicode. It simply requires a font which contains the character you want to display.

### 5.12.1.3 UTF-8 strings

This is the most recommended way to display Unicode. You do not have to use special functions to do so. If UTF-8-encoding is enabled each function of emWin which handles with strings decodes the given text as UTF-8 text.

#### 5.12.1.3.1 Using U2C.exe to convert UTF-8 text into C code

The `Tool` subdirectory of emWin contains the tool `U2C.exe` to convert UTF-8 text to C code. It reads an UTF-8 text file and creates a C file with C strings. The following steps show how to convert a text file into C strings and how to display them with emWin:

##### Step 1: Creating a UTF-8 text file

Save the text to be converted in UTF-8 format. You can use `Notepad.exe` to do this. Load the text under `Notepad.exe`:

```
Japanese:
1 - エンコーディング
2 - テキスト
3 - サポート
English:
1 - encoding
2 - text
3 - support
```

Choose **File** → **Save As...** The file dialog should contain a combo box to set the encoding format. Choose "UTF-8" and save the text file.

##### Step 2: Converting the text file into a C-code file

Start `U2C.exe`. After starting the program you need to select the text file to be converted. After selecting the text file the name of the C file should be selected. Output of `U2C.exe`:

```
"Japanese:"
"1 - \xe3\x82\xa8\xe3\x83\xb3\xe3\x82\xb3\xe3\x83\xbc"
  "\xe3\x83\x87\xe3\x82\xa3\xe3\x83\xb3\xe3\x82\xb0"
"2 - \xe3\x83\x86\xe3\x82\xad\xe3\x82\xb9\xe3\x83\x88"
"3 - \xe3\x82\xb5\xe3\x83\x9d\xe3\x83\xbc\xe3\x83\x88"
"English:"
"1 - encoding"
```



```
"2 - text"  
"3 - support"
```

### Step 3: Using the output in the application code

The following example shows how to display the UTF-8 text with emWin:

```
#include "GUI.h"  
static const char * _apStrings[] = {  
    "Japanese:",  
    "\xe3\x82\xa8\xe3\x83\xb3\xe3\x82\xb3\xe3\x83xbc"  
    "\xe3\x83\x87\xe3\x82\xa3\xe3\x83\xb3\xe3\x82\xb0",  
    "2 - \xe3\x83\x86\xe3\x82\xad\xe3\x82\xb9\xe3\x83\x88",  
    "3 - \xe3\x82\xb5\xe3\x83\x9d\xe3\x83xbc\xe3\x83\x88",  
    "English:",  
    "1 - encoding",  
    "2 - text",  
    "3 - support"  
};  
void MainTask(void) {  
    int i;  
    GUI_Init();  
    GUI_SetFont(&GUI_Font16_1HK);  
    GUI_UC_SetEncodeUTF8();  
    for (i = 0; i < GUI_COUNTOF(_apStrings); i++) {  
        GUI_DispString(_apStrings[i]);  
        GUI_DispNextLine();  
    }  
    while(1) {  
        GUI_Delay(500);  
    }  
}
```

### 5.12.1.4 Unicode API

The table below lists the available routines in alphabetical order within their respective categories. Detailed descriptions of the routines can be found in the sections that follow.

| Routine                              | Description   |
|--------------------------------------|---|
| UTF-8 functions                      |   |
| <code>GUI_UC_ConvertUC2UTF8()</code> | Converts the given double byte Unicode string into UTF-8 format.              |
| <code>GUI_UC_ConvertUTF82UC()</code> | Converts the given UTF-8 string into Unicode format.                          |
| <code>GUI_UC_EnableBIDI()</code>     | This function enables support for bidirectional text.                         |
| <code>GUI_UC_EnableThai()</code>     | This function enables support for Thai script.                                |
| <code>GUI_UC_Encode()</code>         | This function encodes a given character with the current encoding settings.   |
| <code>GUI_UC_GetBaseDir()</code>     | Returns the current basic text direction.                                     |
| <code>GUI_UC_GetCharCode()</code>    | This function decodes a character from a given text.                          |
| <code>GUI_UC_GetCharSize()</code>    | This function returns the number of bytes used to encode the given character. |
| <code>GUI_UC_SetBaseDir()</code>     | Sets the basic text direction to be used.                                     |
| <code>GUI_UC_SetEncodeSJIS()</code>  | Enables SJIS character encoding.  |
| <code>GUI_UC_SetEncodeNone()</code>  | Disables character encoding.  |
| <code>GUI_UC_SetEncodeUTF8()</code>  | Enables UTF-8 encoding.   |
| Double byte functions                |   |
| <code>GUI_UC_DispString()</code>     | This function displays the given double byte string.                          |

### 5.12.1.4.1 UTF-8 functions

#### 5.12.1.4.1.1 GUI\_UC\_ConvertUC2UTF8()

##### Description

Converts the given double byte Unicode string into UTF-8 format.

##### Prototype

```
int GUI_UC_ConvertUC2UTF8(const U16 * s,
                          int      Len,
                          char * pBuffer,
                          int      BufferSize);
```

##### Parameters

| Parameter               | Description                                   |
|-------------------------|---|
| <code>s</code>          | Pointer to Unicode string to be converted.    |
| <code>Len</code>        | Number of Unicode characters to be converted. |
| <code>pBuffer</code>    | Pointer to a buffer to write in the result.   |
| <code>BufferSize</code> | Buffer size in bytes.                         |

##### Return value

The function returns the number of bytes written to the buffer.

##### Additional information

UTF-8 encoded characters can use up to 3 bytes. To be on the safe side the recommended buffer size is: `Number of Unicode characters * 3`.

If the buffer is not big enough for the whole result, the function returns when the buffer is full.

### 5.12.1.4.1.2 GUI\_UC\_ConvertUTF82UC()

#### Description

Converts the given UTF-8 string into Unicode format.

#### Prototype

```
int GUI_UC_ConvertUTF82UC(const char * s,  
                          int      Len,  
                          U16     * pBuffer,  
                          int      BufferSize);
```

#### Parameters

| Parameter               | Description                                    |
|-------------------------|--|
| <code>s</code>          | Pointer to UTF-8 string to be converted.       |
| <code>Len</code>        | Length in bytes of the string to be converted. |
| <code>pBuffer</code>    | Pointer to a buffer to write in the result.    |
| <code>BufferSize</code> | Buffer size in words.                          |

#### Return value

The function returns the number of Unicode characters written to the buffer.

#### Additional information

If the buffer is not big enough for the whole result, the function returns when the buffer is full.

### 5.12.1.4.1.3 GUI\_UC\_EnableBIDI()

#### Description

This function enables support for bidirectional text.

#### Prototype

```
int GUI_UC_EnableBIDI(int OnOff);
```

#### Parameters

| Parameter | Description                                |
|-----------|--|
| OnOff     | 1 to enable BIDI support, 0 to disable it. |

#### Return value

The previous state of BIDI support.

#### Additional information

Once this function is linked approximately 97 KBytes of ROM are additionally used (about 25 KBytes of code and 72 KByte const data). The BiDi module uses a look up table for some characters. This table requires about 72 KByte of ROM. It is possible to reduce the size of this table by enabling (1) or disabling (0) code points with the following:

```
#define GUI_BIDI_SUPPORT_RANGE_<X> 0
```

Where <X> can be: 0, 1, 2, 3, 4, A, D, F

For example:

```
#define GUI_BIDI_SUPPORT_RANGE_2 0  
#define GUI_BIDI_SUPPORT_RANGE_F 0
```

#### 5.12.1.4.1.4 GUI\_UC\_EnableThai()

##### Description

This function enables support for Thai script.

##### Prototype

```
int GUI_UC_EnableThai(int OnOff);
```

##### Parameters

| Parameter | Description                                |
|-----------|--|
| OnOff     | 1 to enable Thai support, 0 to disable it. |

##### Return value

The previous state of Thai support.

##### Additional information

If Thai support is enabled emWin observes 2 situations:

1. If a consonant is followed by a lower vowel the pixel area below the base line must be clipped.
2. If a tone mark should be drawn after an upper vowel the tone mark has to be shifted up to make it visible above the tone mark.

### 5.12.1.4.1.5 GUI\_UC\_Encode()

#### Description

This function encodes a given character with the current encoding settings.

#### Prototype

```
int GUI_UC_Encode(char * s,  
                  U16  Char);
```

#### Parameters

| Parameter | Description   |
|-----------|---|
| s         | Pointer to a buffer to store the encoded character. |
| Char      | Character to be encoded.                            |

#### Return value

The number of bytes stored to the buffer.

#### Additional information

The function assumes that the buffer has at least 3 bytes for the result.

#### 5.12.1.4.1.6 GUI\_UC\_GetBaseDir()

##### Description

Returns the current basic text direction.

##### Prototype

```
int GUI_UC_GetBaseDir(void);
```

##### Return value

Basic text direction.



### 5.12.1.4.1.7 GUI\_UC\_GetCharCode()

#### Description

This function decodes a character from a given text.

#### Prototype

```
U16 GUI_UC_GetCharCode(const char * s);
```

#### Parameters

| Parameter      | Description                        |
|----------------|------------------------------------|
| <code>s</code> | Pointer to the text to be encoded. |

#### Return value

The encoded character.

### 5.12.1.4.1.8 GUI\_UC\_GetCharSize()

#### Description

This function returns the number of bytes used to encode the given character.

#### Prototype

```
int GUI_UC_GetCharSize(const char * s);
```

#### Parameters

| Parameter | Description                        |
|-----------|------------------------------------|
| s         | Pointer to the text to be encoded. |

#### Return value

Number of bytes used to encode the given character.

#### Additional information

This function is used to determine how much bytes a pointer has to be incremented to point to the next character.

#### Example

The following example shows how to use the function:

```
static void _Display2Characters(const char * pText) {
    int Size;
    U16 Character;
    Size      = GUI_UC_GetCharSize(pText); // Size to increment pointer
    Character = GUI_UC_GetCharCode(pText); // Get first character code
    GUI_Dispatch(Character);              // Display first character
    pText    += Size;                     // Increment pointer
    Character = GUI_UC_GetCharCode(pText); // Get next character code
    GUI_Dispatch(Character);              // Display second character
}
```

### 5.12.1.4.1.9 GUI\_UC\_SetBaseDir()

#### Description

Sets the basic text direction to be used.

#### Prototype

```
void GUI_UC_SetBaseDir(int Dir);
```

#### Parameters

| Parameter           | Description       |
|---------------------|-------------------|
| <a href="#">Dir</a> | (see table below) |

| Permitted values for element <a href="#">Dir</a> |  |
|--|--|
| GUI_BIDI_BASEDIR_LTR                             | Basic text direction is 'left to right'.   |
| GUI_BIDI_BASEDIR_RTL                             | Basic text direction is 'right to left'.   |
| GUI_BIDI_BASEDIR_AUTO                            | Basic text direction is calculated automatically: If the first character with strong directionality is RTL the basic text direction is set to RTL. |

#### 5.12.1.4.1.10 GUI\_UC\_SetEncodeSJIS()

##### Description

Enables SJIS character encoding.

##### Prototype

```
void GUI_UC_SetEncodeSJIS(void);
```

##### Additional information

This function call is required before using an SJIS font.

#### 5.12.1.4.1.11 GUI\_UC\_SetEncodeNone()

##### Description

Disables character encoding.

##### Prototype

```
void GUI_UC_SetEncodeNone(void);
```

##### Additional information

After calling this function each byte of a text will be handled as one character. This is the default behavior of emWin.

#### 5.12.1.4.1.12 GUI\_UC\_SetEncodeUTF8()

##### Description

Enables UTF-8 encoding.

##### Prototype

```
void GUI_UC_SetEncodeUTF8(void);
```

##### Additional information

After calling `GUI_UC_SetEncodeUTF8()` each string related routine of emWin encodes a given sting in accordance to the UTF-8 transformation.

## 5.12.1.4.2 Double byte functions

### 5.12.1.4.2.1 GUI\_UC\_DispString()

#### Description

This function displays the given double byte string.

#### Prototype

```
void GUI_UC_DispString(const U16 * s);
```

#### Parameters

| Parameter | Description                    |
|-----------|--------------------------------|
| s         | Pointer to double byte string. |

#### Additional information

If you need to display double byte strings you should use this function. Each character has to be defined by a 16 bit value.

## 5.12.2 Text- and language resource files

To be able to change the text of an application without modifying one line of code the text- and language resource file API functions can be used. They offer the possibility to use one or more simple text files or one CSV (**C**omma **S**eparated **V**alue) file containing text in multiple languages. These files can reside in addressable RAM or at any non addressable medium like NAND flash or a file system.

### 5.12.2.1 Unicode support

If the used range of characters exceeds the ASCII set the text files should contain UTF-8 text. Other encodings like UC16 are not supported by this module.

### 5.12.2.2 Loading files from RAM

When using the files directly from RAM emWin does not allocate the required strings again. It uses the RAM location of the files directly. But because text- and CSV files do not contain zero delimited strings, emWin modifies the given text by replacing the line delimiters (CRLF) (text files) or field delimiters (CSV files) by a zero byte. Therefore the files have to reside in RAM, not in ROM.

### 5.12.2.3 Loading files from non addressable areas

It is also possible to use the files from non addressable areas or any other location in ROM. In these cases emWin uses a GetData function for getting the file data. In the first step (`GUI_LANG_LoadTextEx()`, `GUI_LANG_LoadCSVEx()`) emWin only remembers size and file offset of the text locations within the files. Only when accessing the text with `GUI_LANG_GetText()` the text will be allocated in RAM, read from the file and converted in a legal zero delimited string.

Each time a string gets return by `GUI_LANG_GetText()` it stores the string in the RAM. Once a string is located in the RAM the function returns the string from the RAM. This makes the reading process much faster. If there is not much RAM available it is possible to use the function `GUI_LANG_GetTextBuffered()`. This function uses a buffer of a fixed size and does not keep the string to be displayed in RAM. On the other hand this requires more reading accesses and is slower than reading the string from RAM.

### 5.12.2.4 Rules for CSV files

Because the term 'CSV file' does not exactly determine the file format, here are the rules which have to be obeyed:

- Each record is located on a separate line, delimited by a line break (CRLF).
- The last record in the file may or may not have an ending line break.
- Within each record, there may be one or more fields, separated by delimiters. Each line should contain the same number of fields throughout the file. Spaces are considered part of a field. The last field in the record must not be followed by a delimiter.
- Default field delimiter is a comma. This may be changed using the function `GUI_LANG_SetSep()`.
- Each field may or may not be enclosed in double quotes. If fields are not enclosed with double quotes, then double quotes may not appear inside the fields.
- Fields containing line breaks (CRLF), double quotes, and commas should be enclosed in double-quotes.
- If double-quotes are used to enclose fields, then a double-quote appearing inside a field must be escaped by preceding it with another double quote.

### 5.12.2.5 Rules for text files

A text file is a simple file where each line contains one text element. Rules to obey:

- Each line contains one text item.
- Each line must be delimited by a line break (CRLF).
- Text items containing line breaks are not supported.



### 5.12.2.6 Text- and language resource file API

The table below shows the available routines in alphabetical order. Detailed descriptions of the routines follow.

| Routine                                   | Description  |
|---|--|
| Text file functions                       |  |
| <code>GUI_LANG_LoadText()</code>          | Loads a text file from a RAM location.   |
| <code>GUI_LANG_LoadTextEx()</code>        | Loads a text file using the given <code>GetData</code> function from any area. |
| CSV file functions                        |  |
| <code>GUI_LANG_LoadCSV()</code>           | Loads a CSV file from a RAM location.  |
| <code>GUI_LANG_LoadCSVEx()</code>         | Loads a CSV file from any location by using a <code>GetData</code> function.   |
| Common functions                          |  |
| <code>GUI_LANG_Clear()</code>             | Frees all allocated resources.   |
| <code>GUI_LANG_GetLang()</code>           | Returns the current language index.  |
| <code>GUI_LANG_GetNumItems()</code>       | Returns the number of available text items of the given language.              |
| <code>GUI_LANG_GetText()</code>           | Returns a pointer to the requested text item of the current language.          |
| <code>GUI_LANG_GetTextBuffered()</code>   | Copies the requested text of the current language into the given buffer.       |
| <code>GUI_LANG_GetTextBufferedEx()</code> | Copies the requested text of the given language into the given buffer.         |
| <code>GUI_LANG_GetTextEx()</code>         | Returns a pointer to the requested text item.                                  |
| <code>GUI_LANG_GetTextLen()</code>        | Returns the length of a text item of the current language.                     |
| <code>GUI_LANG_GetTextLenEx()</code>      | Returns the length of a text item.   |
| <code>GUI_LANG_SetLang()</code>           | Sets the language to be used by the function <code>GUI_LANG_GetText()</code> . |
| <code>GUI_LANG_SetMaxNumLang()</code>     | Sets the maximum number of languages to be used.                               |
| <code>GUI_LANG_SetSep()</code>            | Sets the separator to be used when reading a CSV file.                         |

## 5.12.2.6.1 Text file functions

### 5.12.2.6.1.1 GUI\_LANG\_LoadText()

#### Description

Loads a text file from a RAM location.

#### Prototype

```
int GUI_LANG_LoadText(U8 * pFileData,  
                    U32  FileSize,  
                    int  IndexLang);
```

#### Parameters

| Parameter              | Description                            |
|------------------------|--|
| <code>pFileData</code> | Pointer to the first byte of the file. |
| <code>FileSize</code>  | Size of the given file in bytes.       |
| <code>IndexLang</code> | Index of the language.                 |

#### Return value

0        on success.  
1        on error.

#### Additional information

The given file needs to reside in RAM. As explained at the beginning of the chapter emWin converts the given text items into zero delimited strings.

### 5.12.2.6.1.2 GUI\_LANG\_LoadTextEx()

#### Description

Loads a text file using the given `GetData` function from any area.

#### Prototype

```
int GUI_LANG_LoadTextEx(GUI_GET_DATA_FUNC * pfGetData,
                       void * p,
                       int IndexLang);
```

#### Parameters

| Parameter              | Description   |
|------------------------|---|
| <code>pfGetData</code> | Pointer to a <code>_GetData()</code> function to be used for file access. |
| <code>p</code>         | Pointer passed to the <code>_GetData()</code> function.                   |
| <code>IndexLang</code> | Index of the language.  |

#### Return value

0 on success.  
1 on error.

#### Additional information

Data is accessed by the given `GetData` function. The pointer `p` can be used by the application.

#### Prototype of the 'GetData' function

```
int GUI_GET_DATA_FUNC( void * p,
                       const U8 ** ppData,
                       unsigned NumBytesReq,
                       U32 Off);
```

| Parameter                | Description  |
|--------------------------|--|
| <code>p</code>           | Application defined void pointer.  |
| <code>ppData</code>      | The location the pointer points to has to be filled by the 'GetData' function. |
| <code>NumBytesReq</code> | Number of requested bytes.   |
| <code>Off</code>         | Offset to be used to address the requested bytes within the file.              |

#### Example

The following shows a sample implementation of the `GetData` function for use under Windows:

```
static int _GetData(void * pVoid, const U8 ** ppData, unsigned NumBytes, U32 Off) {
    DWORD NumBytesRead;
    HANDLE hFile;
    U8 * pData;
    pData = (U8 *)*ppData;
    hFile = *(HANDLE *)pVoid;
    if (SetFilePointer(hFile, Off, 0, FILE_BEGIN) == 0xFFFFFFFF) {
        return 0;
    }
    if (!ReadFile(hFile, pData, NumBytes, &NumBytesRead, 0)) {
        return 0;
    }
    return NumBytesRead;
}
```

## 5.12.2.6.2 CSV file functions

### 5.12.2.6.2.1 GUI\_LANG\_LoadCSV()

#### Description

Loads a CSV file from a RAM location.

#### Prototype

```
int GUI_LANG_LoadCSV(U8 * pFileData,  
                    U32  FileSize);
```

#### Parameters

| Parameter              | Description                            |
|------------------------|--|
| <code>pFileData</code> | Pointer to the first byte of the file. |
| <code>FileSize</code>  | Size of the given file in bytes.       |

#### Return value

The function returns the number of available languages of the given file.

#### Additional information

The given file needs to reside in RAM. As explained at the beginning of the chapter emWin converts the given text items to zero delimited strings. This function call first deletes all existing text resources. It is not possible to use a text file including one language and a CSV file including further languages. Either text files or CSV files should be used.

### 5.12.2.6.2.2 GUI\_LANG\_LoadCSVEx()

#### Description

Loads a CSV file from any location by using a `GetData` function.

#### Prototype

```
int GUI_LANG_LoadCSVEx(GUI_GET_DATA_FUNC * pfGetData,  
                      void * p);
```

#### Parameters

| Parameter              | Description   |
|------------------------|---|
| <code>pfGetData</code> | Pointer to a <code>_GetData()</code> function to be used for file access. |
| <code>p</code>         | Pointer passed to the <code>_GetData()</code> function.                   |

#### Return value

The function returns the number of available languages.

#### Additional information

As explained at the beginning of the chapter `emWin` converts the given text items to zero delimited strings. This function call first deletes all existing text resources. It is not possible to use a text file including one language and a CSV file including further languages. Either text files or CSV files should be used. If the return value is 0 it might be possible that the maximum number of languages is too small. Call `GUI_LANG_SetMaxNumLang()` to increase the number of languages.

### 5.12.2.6.3 Common functions

#### 5.12.2.6.3.1 GUI\_LANG\_Clear()

##### Description

Frees all allocated resources.

##### Prototype

```
void GUI_LANG_Clear(void);
```

### 5.12.2.6.3.2 GUI\_LANG\_GetLang()

#### Description

Returns the current language index.

#### Prototype

```
int GUI_LANG_GetLang(void);
```

#### Return value

Current index of the language.

### 5.12.2.6.3.3 GUI\_LANG\_GetNumItems()

#### Description

Returns the number of available text items of the given language.

#### Prototype

```
int GUI_LANG_GetNumItems(int IndexLang);
```

#### Parameters

| Parameter              | Description                  |
|------------------------|------------------------------|
| <code>IndexLang</code> | Index of the given language. |

#### Return value

Number of available text items of the given language.



#### 5.12.2.6.3.4 GUI\_LANG\_GetText()

##### Description

Returns a pointer to the requested text item of the current language.

##### Prototype

```
char *GUI_LANG_GetText(int IndexText);
```

##### Parameters

| Parameter              | Description                            |
|------------------------|--|
| <code>IndexText</code> | Index of the text item to be returned. |

##### Return value

Pointer to the requested text item.

##### Additional information

If a `GetData` function is used, the first time a text item is requested it will be allocated, read and converted once. In case of using a `GetData` function this could save memory if not all text items are used by the application.

### 5.12.2.6.3.5 GUI\_LANG\_GetTextBuffered()

#### Description

Copies the requested text of the current language into the given buffer.

#### Prototype

```
int GUI_LANG_GetTextBuffered(int    IndexText,
                             char * pBuffer,
                             int    SizeOfBuffer);
```

#### Parameters

| Parameter                    | Description                               |
|------------------------------|---|
| <a href="#">IndexText</a>    | Index of the text item to be returned.    |
| <a href="#">pBuffer</a>      | Pointer to an application defined buffer. |
| <a href="#">SizeOfBuffer</a> | Size of the application defined buffer.   |

#### Return value

- 0        on success.
- 1        if the text could not be found.

### 5.12.2.6.3.6 GUI\_LANG\_GetTextBufferedEx()

#### Description

Copies the requested text of the given language into the given buffer.

#### Prototype

```
int GUI_LANG_GetTextBufferedEx(int    IndexText,
                              int    IndexLang,
                              char * pBuffer,
                              int    SizeOfBuffer);
```

#### Parameters

| Parameter                    | Description                               |
|------------------------------|---|
| <a href="#">IndexText</a>    | Index of the text item to be returned.    |
| <a href="#">IndexLang</a>    | Index of the language.                    |
| <a href="#">pBuffer</a>      | Pointer to an application defined buffer. |
| <a href="#">SizeOfBuffer</a> | Size of the application defined buffer.   |

#### Return value

- 0        on success.
- 1        if the text could not be found.

### 5.12.2.6.3.7 GUI\_LANG\_GetTextEx()

#### Description

Returns a pointer to the requested text item.

#### Prototype

```
char *GUI_LANG_GetTextEx(int IndexText,  
                        int IndexLang);
```

#### Parameters

| Parameter                 | Description                            |
|---------------------------|--|
| <a href="#">IndexText</a> | Index of the text item to be returned. |
| <a href="#">IndexLang</a> | Index of the requested language.       |

#### Return value

Pointer to the requested text item.

#### Additional information

If a `GetData` function is used, the first time a text item is requested it will be allocated, read and converted once. In case of using a `GetData` function this could save memory if not all text items are used by the application.

### 5.12.2.6.3.8 GUI\_LANG\_GetTextLen()

#### Description

Returns the length of a text item of the current language.

#### Prototype

```
int GUI_LANG_GetTextLen(int IndexText);
```

#### Parameters

| Parameter              | Description             |
|------------------------|-------------------------|
| <code>IndexText</code> | Index of the text item. |

#### Return value

-1      Error. != -1: Length of the text item.

### 5.12.2.6.3.9 GUI\_LANG\_GetTextLenEx()

#### Description

Returns the length of a text item.

#### Prototype

```
int GUI_LANG_GetTextLenEx(int IndexText,  
                          int IndexLang);
```

#### Parameters

| Parameter                 | Description             |
|---------------------------|-------------------------|
| <a href="#">IndexText</a> | Index of the text item. |
| <a href="#">IndexLang</a> | Index of the language.  |

#### Return value

-1 Error. != -1: Length of the text item.

### 5.12.2.6.3.10 GUI\_LANG\_SetLang()

#### Description

Sets the language to be used by the function `GUI_LANG_GetText()`.

#### Prototype

```
int GUI_LANG_SetLang(int IndexLang);
```

#### Parameters

| Parameter              | Description                       |
|------------------------|-----------------------------------|
| <code>IndexLang</code> | Index of the language to be used. |

#### Return value

Previous index of the language.

### 5.12.2.6.3.11 GUI\_LANG\_SetMaxNumLang()

#### Description

Sets the maximum number of languages to be used.

#### Prototype

```
unsigned GUI_LANG_SetMaxNumLang(unsigned MaxNumLang);
```

#### Parameters

| Parameter                  | Description                 |
|----------------------------|-----------------------------|
| <a href="#">MaxNumLang</a> | Maximum number of languages |

#### Return value

Previous maximum number of languages.

#### Additional information

This function has to be called before any other function of the language module is called. A good place for the function call would be `GUI_X_Config()`.



### 5.12.2.6.3.12 GUI\_LANG\_SetSep()

#### Description

Sets the separator to be used when reading a CSV file.

#### Prototype

```
U16 GUI_LANG_SetSep(U16 Sep);
```

#### Parameters

| Parameter           | Description                         |
|---------------------|-------------------------------------|
| <a href="#">Sep</a> | Separator to be used for CSV files. |

#### Return value

Previously used separator.

#### Additional information

The default separator is a comma. Some applications use TABs or semicolons as separator. This function can be used to change the separator. It does not check if the given separator makes sense. So it is the applications responsibility to set the right value. The function has no effect on reading text files.

### 5.12.3 Right to left- and bidirectional text

Whereas most scripts are written from the left to the right (LTR), there are some scripts like Hebrew and Arabic which are written from the right to the left (RTL). Bidirectional (BIDI) text contains text with both directionalities. To be able to apply the correct visual alignment, a couple of rules need to be followed to get the right visual alignment of the text. BIDI text support is part of the emWin basic package.

#### 5.12.3.1 Bidirectional text algorithm

The Unicode consortium has defined the rules for combining RTL- and LTR text in the Unicode standard. It prescribes an algorithm for how to convert the logical sequence of characters into the correct visual presentation observing a set of rules. emWin follows up these rules to get the right visual order before drawing the text. It observes the rules of the bidirectional text algorithm of the Unicode standard 8.0.0.

#### Example

The following example shows how bidirectional text is rendered by emWin:

| UTF-8 text   | Rendering |
|--|-----------|
| <pre>\xd8\xb9\xd9\x84\xd8\xa7 1, 2, 345 \xd8\ba\xd9\x86\xd9\x8a XYZ \xd8\xa3\xd9\x86\xd8\xa7</pre> |           |

#### 5.12.3.2 Basic text direction

It is important to set the appropriate base direction for text so that the bidirectional algorithm produces the expected ordering of the text. The visual order of text, especially text with brackets and single RTL characters, depends on the basic text direction.

#### Example

The following example shows a simple text with different basic text directions:

| Basic text direction  | Rendering |
|-----------------------|-----------|
| GUI_BIDI_BASEDIR_RTL  |           |
| GUI_BIDI_BASEDIR_AUTO |           |

#### 5.12.3.3 Mirroring

emWin also supports mirroring of some neutral characters in RTL aligned text. This is important if for example RTL aligned text contains parenthesis. The mirroring is done by replacing the code of the character to be mirrored with the code of a mirror partner whose image fits to the mirrored image. This is done by a fast way using a table containing all characters with existing mirror partners. Note that support for mirroring further characters is not supported.

#### 5.12.3.4 Requirements

The bidirectional text alignment uses approx. 80 KB of ROM and approx. 800 bytes of additional stack.

#### 5.12.3.5 Maximum characters per line

The maximum number of characters in bidirectional text **per line** is limited to 200 by default. In case this has to be changed, e.g. if more characters are needed, the user may

change the define `GUI_BIDI_MAX_CHARS_PER_LINE` located in the file `GUI_ConfDefaults.h`. Note that one character equals to 4 bytes of stack needed.

```
#define GUI_BIDI_MAX_CHARS_PER_LINE 200
```

## 5.12.4 Arabic support

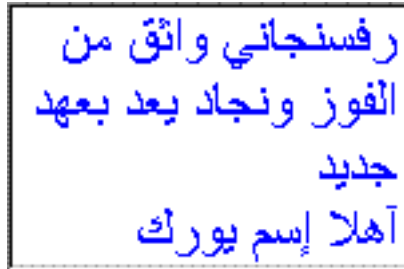

The basic difference between western languages and Arabic is, that Arabic scripts are written from the right to the left and that it does not know uppercase and lowercase characters. Further the character codes of the text are not identical with the character index in the font file used to render the character, because the notation forms of the characters depend on the positions in the text. Arabic support is part of the emWin basic package.

### 5.12.4.1 Notation forms

The Arabic base character set is defined in the Unicode standard within the range from 0x0600 to 0x06FF. Unfortunately these character codes can not directly be used to get the character of the font for drawing it, because the notation form depends on the character position in the text. One character can have up to 4 different notation forms:

- One, if it is at the beginning of a word (**initial**)
- One, if it is at the end of a word (**final**)
- One, if it is in the middle of a word (**medial**)
- One, if the character stands alone (**isolated**)

But not each character is allowed to be joined to the left and to the right (double-joined). The character Hamza for example always needs to be separated and Alef is only allowed at the end or separated. Character combinations of the letters Lam and Alef should be transformed to a ligature. This means one character substitutionally for the combination of Lam and Alef.

The above description shows, that the notation form is normally not identical to the character code of the text. The following table shows how emWin transforms the characters to the notation form in dependence of the text position:

| Base   | Isolated | Final  | Initial | Medial  | Character             |
|--------|----------|--------|---------|---------|-----------------------|
| 0x0621 | 0xFE80   | -      | -       | -       | Hamza                 |
| 0x0622 | 0xFE81   | 0xFE82 | -       | -       | Alef with Madda above |
| 0x0623 | 0xFE83   | 0xFE84 | -       | -       | Alef with Hamza above |
| 0x0624 | 0xFE85   | 0xFE86 | -       | -       | Waw with Hamza above  |
| 0x0625 | 0xFE87   | 0xFE88 | -       | -       | Alef with Hamza below |
| 0x0626 | 0xFE89   | 0xFE8A | 0xFE8B  | 0xFE8C  | Yeh with Hamza above  |
| 0x0627 | 0xFE8D   | 0xFE8E | -       | -       | Alef                  |
| 0x0628 | 0xFE8F   | 0xFE90 | 0xFE91  | 0xFE92  | Beh                   |
| 0x0629 | 0xFE93   | 0xFE94 | -       | -       | Teh Marbuta           |
| 0x062A | 0xFE95   | 0xFE96 | 0xFE97  | 0xFE98  | Teh                   |
| 0x062B | 0xFE99   | 0xFE9A | 0xFE9B  | 0xFE9C  | Theh                  |
| 0x062C | 0xFE9D   | 0xFE9E | 0xFE9F  | 0xFE9A0 | Jeem                  |

| Base   | Isolated | Final  | Initial | Medial | Character    |
|--------|----------|--------|---------|--------|--------------|
| 0x062D | 0xFEA1   | 0xFEA2 | 0xFEA3  | 0xFEA4 | Hah          |
| 0x062E | 0xFEA5   | 0xFEA6 | 0xFEA7  | 0xFEA8 | Khah         |
| 0x062F | 0xFEA9   | 0xFEAA | -       | -      | Dal          |
| 0x0630 | 0xFEAB   | 0xFEAC | -       | -      | Thal         |
| 0x0631 | 0xFEAD   | 0xFEAE | -       | -      | Reh          |
| 0x0632 | 0xFEAF   | 0xFEB0 | -       | -      | Zain         |
| 0x0633 | 0xFEB1   | 0xFEB2 | 0xFEB3  | 0xFEB4 | Seen         |
| 0x0634 | 0xFEB5   | 0xFEB6 | 0xFEB7  | 0xFEB8 | Sheen        |
| 0x0635 | 0xFEB9   | 0xFEBA | 0xFEBB  | 0xFEBC | Sad          |
| 0x0636 | 0xFEBD   | 0xFEBE | 0xFEBF  | 0xFEC0 | Dad          |
| 0x0637 | 0xFEC1   | 0xFEC2 | 0xFEC3  | 0xFEC4 | Tah          |
| 0x0638 | 0xFEC5   | 0xFEC6 | 0xFEC7  | 0xFEC8 | Zah          |
| 0x0639 | 0xFEC9   | 0xFECA | 0xFECB  | 0xFECC | Ain          |
| 0x063A | 0xFECD   | 0xFECE | 0xFECF  | 0xFED0 | Ghain        |
| 0x0641 | 0xFED1   | 0xFED2 | 0xFED3  | 0xFED4 | Feh          |
| 0x0642 | 0xFED5   | 0xFED6 | 0xFED7  | 0xFED8 | Qaf          |
| 0x0643 | 0xFED9   | 0xFEDA | 0xFEDB  | 0xFEDC | Kaf          |
| 0x0644 | 0xFEDD   | 0xFEDE | 0xFEDF  | 0xFEE0 | Lam          |
| 0x0645 | 0xFEE1   | 0xFEE2 | 0xFEE3  | 0xFEE4 | Meem         |
| 0x0646 | 0xFEE5   | 0xFEE6 | 0xFEE7  | 0xFEE8 | Noon         |
| 0x0647 | 0xFEE9   | 0xFEEA | 0xFEEB  | 0xFEEC | Heh          |
| 0x0648 | 0xFEED   | 0xFEEE | -       | -      | Waw          |
| 0x0649 | 0xFEEF   | 0xFEFO | -       | -      | Alef Maksura |
| 0x064A | 0xFEFF   | 0xFEFF | 0xFEFF  | 0xFEFF | Yeh          |
| 0x067E | 0xFB56   | 0xFB57 | 0xFB58  | 0xFB59 | Peh          |
| 0x0686 | 0xFB7A   | 0xFB7B | 0xFB7C  | 0xFB7D | Tchah        |
| 0x0698 | 0xFB8A   | 0xFB8B | -       | -      | Jeh          |
| 0x06A9 | 0xFB8E   | 0xFB8F | 0xFB90  | 0xFB91 | Keheh        |
| 0x06AF | 0xFB92   | 0xFB93 | 0xFB94  | 0xFB95 | Gaf          |
| 0x06CC | 0xFBFC   | 0xFBFD | 0xFBFE  | 0xFBFF | Farsi Yeh    |

### 5.12.4.2 Ligatures

Character combinations of Lam and Alef are transformed into ligatures. The following table shows how emWin transforms these combinations into ligatures, if the first letter is a Lam (code 0x0644):

| Second letter                | Ligature (final) | Ligature (elsewhere) |
|------------------------------|------------------|----------------------|
| 0x622, Alef with Madda above | 0xFEFF6          | 0xFEFF5              |
| 0x623, Alef with Hamza above | 0xFEFF8          | 0xFEFF7              |
| 0x625, Alef with Hamza below | 0xFEFFA          | 0xFEFF9              |
| 0x627, Alef                  | 0xFEFFC          | 0xFEFFB              |

### 5.12.4.3 How to enable Arabic support

Per default emWin writes text always from the left to the right and there will be no Arabic character transformation as described above. To enable support for bidirectional text and Arabic character transformation, add the following line to your application:

```
GUI_UC_EnableBIDI(1);
```

If enabled, emWin follows the rules of the bidirectional algorithm, described by the Unicode consortium, to get the right visual order before drawing text.

### 5.12.4.4 Example

The `Sample` folder contains the example `FONT_Arabic`, which shows how to draw Arabic text. It contains an emWin font with Arabic characters and some small Arabic text examples.

### 5.12.4.5 Font files used with Arabic text

Font files used to render Arabic text need to include at least all characters defined in the Arabic range `0x600-0x6FF` and the notation forms and ligatures listed in the tables of this chapter.

## 5.12.5 Thai language support

Nice to meet you.

ยินดีที่ได้รู้จัก

The Thai alphabet uses 44 consonants and 15 basic vowel characters. These are horizontally placed, left to right, with no intervening space, to form syllables, words, and sentences. Vowels are written above, below, before, or after the consonant they modify, although the consonant always sounds first when the syllable is spoken. The vowel characters (and a few consonants) can be combined in various ways to produce numerous compound vowels (diphthongs and triphthongs).

### 5.12.5.1 Requirements

As explained above the Thai language makes an extensive usage of compound characters. To be able to draw compound characters in emWin, a new font type is needed, which contains all required character information like the image size, image position and cursor incrementation value. From version 4.00 emWin supports a new font type with this information. This also means that older font types can not be used to draw Thai text.

#### Note

The standard fonts of emWin do not contain font files with Thai characters. To create a Thai font file, the Font Converter of version 3.04 or newer is required.

#### Memory

The Thai language support does not need additional ROM nor RAM.

### 5.12.5.2 How to enable Thai support

Support of the Thai language has to be enabled by calling `GUI_UC_EnableThai()`.

### 5.12.5.3 Example

The `sample` folder contains the example `FONT_ThaiText.c`, which shows how to draw Thai text. It contains an emWin font with Thai characters and some small Thai text examples.

### 5.12.5.4 Font files used with Thai text

Font files used to render Thai text need to include at least all characters defined in the Thai range `0xE00-0xE7F`.

## 5.12.6 Shift JIS support

Shift JIS (Japanese Industry Standard) is a character encoding method for the Japanese language. It is the most common Japanese encoding method. Shift JIS encoding makes generous use of 8-bit characters, and the value of the first byte is used to distinguish single- and multiple-byte characters.

The Shift JIS support of emWin is only needed if text with Shift JIS encoding needs to be rendered.

You need no special function calls to draw a Shift JIS string. The main requirement is a font file which contains the Shift JIS characters.

### 5.12.6.1 Creating Shift JIS fonts

The Font Converter can generate a Shift JIS font for emWin from any Windows font. When using a Shift JIS font, the functions used to display Shift JIS characters are linked automatically with the library.

Detailed information on how to create Shift-JIS fonts and implement them in a project can be found in the chapter *Font Converter* on page 2832.

## 5.12.7 Limitations

Currently emWin is not able to make text transitions required for drawing Devanagari and similar scripts. It does not contain an engine for complete complex script support. Because of this only RTF and Arabic transitions are supported.



## 5.13 Timing- and execution-related functions

Some widgets, as well as our demonstration code, require time-related functions. The other parts of the emWin graphic library do not require a time base.

The demonstration code makes heavy use of the routine `GUI_Delay()`, which delays for a given period of time. A unit of time is referred to as a tick.

### 5.13.1 Timing and execution API

The table below lists the available timing- and execution-related routines in alphabetical order. Detailed descriptions of the routines follow.

| Routine                         | Description  |
|---------------------------------|--|
| <code>GUI_Delay()</code>        | Delays for a specified period of time.   |
| <code>GUI_Exec()</code>         | Executes callback functions (typically redrawing of windows).  |
| <code>GUI_Exec1()</code>        | Executes a callback function (one job only; typically redrawing a window).   |
| <code>GUI_GetTime()</code>      | Returns the current system time.   |
| <code>GUI_GetTimeSlice()</code> | Returns the currently set minimum time in milliseconds with which a <code>GUI_X_Delay()</code> will get called within <code>GUI_Delay()</code> . |
| <code>GUI_SetTimeSlice()</code> | Sets the minimum time with which a <code>GUI_X_Delay()</code> gets called within <code>GUI_Delay()</code> .                                      |

### 5.13.1.1 GUI\_Delay()

#### Description

Delays for a specified period of time.

#### Prototype

```
void GUI_Delay(int Period);
```

#### Parameters

| Parameter           | Description   |
|---------------------|---|
| <code>Period</code> | Minimum period in ticks until function should return. |

#### Additional information

The time unit (tick) is usually milliseconds (depending on `GUI_X_` functions). `GUI_Delay()` only executes idle functions for the given period. If the Window Manager is used, the delay time is used for the updating of invalid windows (through execution of `WM_Exec()`). Please note that the given period is a minimum period. Larger drawing operations of the WM for example could take more time than the given period. This function will call `GUI_X_Delay()`.

### 5.13.1.2 GUI\_Exec()

#### Description

Executes callback functions (typically redrawing of windows).

#### Prototype

```
int GUI_Exec(void);
```

#### Return value

0        if there were no jobs performed.  
1        if a job was performed.

#### Additional information

This function will automatically call `GUI_Exec1()` repeatedly until it has completed all jobs—essentially until a 0 value is returned. Normally this function does not need to be called by the user application. It is called automatically by `GUI_Delay()`.

### 5.13.1.3 GUI\_Exec1()

#### Description

Executes a callback function (one job only; typically redrawing a window).

#### Prototype

```
int GUI_Exec1(void);
```

#### Return value

- 0 if there were no jobs performed.
- 1 if a job was performed.

#### Additional information

This routine may be called repeatedly until 0 is returned, which means all jobs have been completed. This function is called automatically by `GUI_Exec()`.

### 5.13.1.4 GUI\_GetTime()

#### Description

Returns the current system time.

#### Prototype

```
GUI_TIMER_TIME GUI_GetTime(void);
```

#### Return value

The current system time in ticks.

#### Additional information

This function calls `GUI_X_GetTime()`. `GUI_TIMER_TIME` is explained under `GUI_TIMER_TIME`.

### 5.13.1.5 GUI\_GetTimeSlice()

#### Description

Returns the currently set minimum time in milliseconds with which a `GUI_X_Delay()` will get called within `GUI_Delay()`.

#### Prototype

```
int GUI_GetTimeSlice(void);
```

#### Return value

Value set as time slice in ms.

#### Additional information

Prior to version 5.38 of emWin the minimum time a `GUI_Delay()` took was 5ms. With the function `GUI_SetTimeSlice()` the minimum time can be set.

### 5.13.1.6 GUI\_SetTimeSlice()

#### Description

Sets the minimum time with which a `GUI_X_Delay()` gets called within `GUI_Delay()`.

#### Prototype

```
void GUI_SetTimeSlice(int TimeSlice);
```

#### Parameters

| Parameter              | Description   |
|------------------------|---|
| <code>TimeSlice</code> | Minimum time to be used within a <code>GUI_Delay()</code> . |

#### Additional information

The default value for the minimum time is 5ms.

## 5.13.2 Verbosity API

The table below lists the available verbosity related routines in alphabetical order. Detailed descriptions of the routines follow.

| <b>Routine</b>                 | <b>Description</b>                                     |
|--------------------------------|--|
| <a href="#">GUI_ErrorOut()</a> | Shows a message box with an error and stops execution. |
| <a href="#">GUI_Log()</a>      | Prints out logging messages.                           |
| <a href="#">GUI_Warn()</a>     | Prints out warning messages.                           |



### 5.13.2.1 GUI\_ErrorOut()

#### Description

Shows a message box with an error and stops execution. This function is called by emWin in case of serious errors which causes the system to stop execution. A pointer to a string is passed which contains a short error description. The error message contains the module and function where the error occurred and a short description. The simulation automatically shows a message box with the error message in debug mode. To be able to intercept these major errors on the target system, the function `GUI_SetOnErrorFunc()` can be used to set up a custom routine which is called by `GUI_ErrorOut()`.

#### Prototype

```
void GUI_ErrorOut(const char * s);
```

#### Parameters

| Parameter | Description  |
|-----------|--|
| s         | Error string which is passed on to the function <code>GUI_X_ErrorOut()</code> and to the user defined error handling function. |

#### Additional information

Detailed information on how to set up a user defined error handling function can be found in the description of the function `GUI_SetOnErrorFunc()` in the chapter *Configuration* on page 100.

### 5.13.2.2 GUI\_Log()

#### Description

Prints out logging messages. Logging messages printed for example when memory for handles is allocated or freed. A pointer to a string is passed which contains the logging message. It contains the module and function where the log message was sent and a short description. To be able to intercept these loggings on the target system, the function `GUI_SetOnLogFunc()` can be used to set up a custom routine which is called by `GUI_Log()`.

#### Prototype

```
void GUI_Log(const char * s);
```

#### Parameters

| Parameter | Description   |
|-----------|---|
| s         | Error string which is passed on to the function <code>GUI_X_Log()</code> and to the user defined error handling function. |

#### Additional information

Detailed information on how to set up a user defined logging handling function can be found in the description of the function `GUI_SetOnLogFunc()` in the chapter *Configuration* on page 100.

### 5.13.2.3 GUI\_Warn()

#### Description

Prints out warning messages. For example when false parameters have been passed to a function, a warning will be printed with this function. A pointer to a string is passed which contains a short warning. The string contains the module and function where the warning occurred and a short description. To be able to intercept these warnings on the target system, the function `GUI_SetOnWarnFunc()` can be used to set up a custom routine which is called by `GUI_Warn()`.

#### Prototype

```
void GUI_Warn(const char * s);
```

#### Parameters

| Parameter | Description  |
|-----------|--|
| s         | Error string which is passed on to the function <code>GUI_X_Warn()</code> and to the user defined warning handling function. |

#### Additional information

Detailed information on how to set up a user defined error handling function can be found in the description of the function `GUI_SetOnErrorFunc()` in the chapter *Configuration* on page 100.

### 5.13.3 Timer API

The table below lists the available timer-related routines in alphabetical order. Detailed descriptions of the routines follow.

| <b>Routine</b>                     | <b>Description</b>        |
|------------------------------------|---------------------------|
| <code>GUI_TIMER_Create()</code>    | Creates a timer.          |
| <code>GUI_TIMER_Delete()</code>    | Deletes the given timer.  |
| <code>GUI_TIMER_Restart()</code>   | Restarts the given timer. |
| <code>GUI_TIMER_SetPeriod()</code> | Sets the timer period.    |

### 5.13.3.1 GUI\_TIMER\_Create()

#### Description

Creates a timer. When the timer expires the timer callback function is called.

#### Prototype

```
GUI_TIMER_HANDLE GUI_TIMER_Create(GUI_TIMER_CALLBACK * cb,
                                  GUI_TIMER_TIME      Time,
                                  PTR_ADDR            Context,
                                  U16                 Flags);
```

#### Parameters

| Parameter            | Description   |
|----------------------|---|
| <code>cb</code>      | Pointer to the user defined timer callback function which is called when the timer expires. Prototype is shown below. |
| <code>Time</code>    | Destination time. The created timer expires when the system time exceeds this value.                                  |
| <code>Context</code> | Timer context which is returned unchanged via timer callback function.  |
| <code>Flags</code>   | Not used. Reserved for future use.  |

#### GUI\_TIMER\_CALLBACK

```
typedef void GUI_TIMER_CALLBACK(GUI_TIMER_MESSAGE * pTM);
```

| Parameter        | Description  |
|------------------|--|
| <code>pTM</code> | Pointer to a <code>GUI_TIMER_MESSAGE</code> structure which is explained below. Changes which are done from within the callback function are not applied. In order to have another context, a new timer should be created. |

#### Elements of structure GUI\_TIMER\_MESSAGE

| Data type                     | Element              | Description  |
|-------------------------------|----------------------|--|
| <code>GUI_TIMER_TIME</code>   | <code>Time</code>    | Contains the time value when the timer expired.                          |
| <code>U32</code>              | <code>Context</code> | User defined context value which was specified at creation of the timer. |
| <code>GUI_TIMER_HANDLE</code> | <code>hTimer</code>  | Handle of the expired timer.   |

#### GUI\_TIMER\_TIME

This define can be set to the desired type in the file `GUIConf.h`. The default type is `int`.

#### Note

The data type must be signed.

#### Return value

Handle to the created timer. 0, if no timer was created.

#### Additional information

Timers are not deleted automatically. To delete a timer the function `GUI_TIMER_Delete()` can be used. Restarting a timer can be achieved with `GUI_TIMER_Restart()`.

### 5.13.3.2 GUI\_TIMER\_Delete()

#### Description

Deletes the given timer.

#### Prototype

```
void GUI_TIMER_Delete(GUI_TIMER_HANDLE hObj);
```

#### Parameters

| Parameter         | Description   |
|-------------------|---------------|
| <code>hObj</code> | Timer handle. |

#### Return value

Handle to the created timer. 0, if no timer was created.

#### Additional information

Timers are deleted immediately. After deleting a timer the according callback function will not be triggered.

### 5.13.3.3 GUI\_TIMER\_Restart()

#### Description

Restarts the given timer.

#### Prototype

```
void GUI_TIMER_Restart(GUI_TIMER_HANDLE hObj);
```

#### Parameters

| Parameter         | Description   |
|-------------------|---------------|
| <code>hObj</code> | Timer handle. |

### 5.13.3.4 GUI\_TIMER\_SetPeriod()

#### Description

Sets the timer period. The period defines the time which has to pass until the callback function is triggered again.

#### Prototype

```
void GUI_TIMER_SetPeriod(GUI_TIMER_HANDLE hObj,  
                        GUI_TIMER_TIME  Period);
```

#### Parameters

| Parameter              | Description   |
|------------------------|---------------|
| <a href="#">hObj</a>   | Timer handle. |
| <a href="#">Period</a> | Timer period. |

#### Additional information

This period is used only when the timer is restarted.



# Chapter 6

## Advanced features

---

The following chapter contains all advanced emWin features. Some of these features are part of the **emWin PRO package** and they all can be purchased separately.

- The Window Manager (WM)
- Widgets (window objects)
- Dialogs
- Skinning
- Anti-aliasing
- Memory Devices
- MultiTouch support (MT)
- VNC Server

## 6.1 The Window Manager (WM)

When using the emWin Window Manager (WM), everything which appears on the display is contained in a window—a rectangular area on the screen. A window can be of any size, and you can display multiple windows on the screen at once, even partially or entirely in front of other windows.

The Window Manager supplies a set of routines which allow you to easily create, move, resize, and otherwise manipulate any number of windows. It also provides lower-level support by managing the layering of windows on the display and by alerting your application to display changes that affect its windows.

The emWin Window Manager is a separate (optional) software item and is not included in the emWin basic package. The software for the Window Manager is located in the subdirectory `GUI\WM`.

### 6.1.1 Description of terms

Windows are rectangular in shape, defined by their origin (the X- and Y-coordinates of the upper left corner) as well as their X- and Y-sizes (width and height, respectively). A window in emWin:

- is rectangular.
- has a Z-position.
- may be hidden or shown.
- may have valid and/or invalid areas.
- may or may not have transparency.
- may or may not have a callback routine.

#### Active window

The window which is currently being used for drawing operations is referred to as the active window. It is not necessarily the same as the topmost window.

#### Callback routines

Callback routines are defined by the user program, instructing the graphic system to call a specific function when a specific event occurs. Normally they are used to automatically redraw a window when its content has changed.

#### Child windows

A child window is one that is defined relative to another window, called the parent. Whenever a parent window moves, its child or children move correspondingly. A child window is always completely contained within its parent, and will be clipped if necessary. Multiple child windows with the same parent are considered "siblings" to one another.

#### Client area

The client area of a window is simply its usable area. If a window contains a frame or title bar, then the client area is the rectangular inner area. If there is no such frame, then the coordinates of the client area are identical to those of the window itself.

#### Clipping, clip area

Clipping is the process of limiting output to a window or part of it. The clip area of a window is its visible area. This is the window area minus the area obstructed by siblings of higher Z-order, minus any part that does not fit into the visible area of the parent window.

#### Coordinates

Coordinates are usually 2 dimensional coordinates, expressed in units of pixels. A coordinate consists of 2 values. The first value specifies the horizontal component (also called the x-coordinate), the second value specifies the vertical component (also called the y-coordinate).

## Current window

See active window.

## Desktop coordinates

Desktop coordinates are coordinates of the desktop window. The upper left position (the origin) of the display is (0,0).

## Desktop window

The desktop window is automatically created by the Window Manager, and always covers the entire display area. This is done for each layer, so each layer has its own desktop window. The desktop is always the bottommost window, and when no other window has been defined, it is the default (active) window. All windows are descendants (children, grandchildren, etc.) of the desktop window of the currently selected layer. The desktop window has a buffer which can hold data with the size of a void data type. This allows the user to add user data, e.g. a pointer to a structure.

## Early clipping

This is the default clipping mode. In this mode clipping is performed before windows receive paint events. In case the current window needs to be clipped, it will receive more than one `WM_PAINT` message within a single drawing process.

In the late clipping mode, windows always receive only one single `WM_PAINT` message. In this mode clipping is performed within the drawing operations.

## Handle

When a new window is created, the WM assigns it a unique identifier called a handle. The handle is used in any further operations performed on that particular window.

## Hiding windows

A hidden window is not visible, although it still exists (has a handle). When a window is created, it is hidden by default if no create flag is specified. Showing a window makes it visible; hiding it makes it invisible.

## Late clipping

See early clipping.

## Parent coordinates

Parent coordinates are window coordinates relative to the parent window. The upper left position (the origin) of the window is (0,0).

## Parent windows

See child windows.

## Showing windows

See Hiding windows.

## Siblings

See child windows.

## Transparency

A window that has transparency contains areas that are not redrawn with the rest of the window. These areas operate as though the window behind "shows through" them. In this case, it is important that the window behind is redrawn before the window with transparency. The WM automatically handles redrawing in the correct order.

### **Validation/invalidation**

A valid window is a fully updated window which does not need redrawing. An invalid window does not yet reflect all updates and therefore needs to be redrawn, either completely or partially. When changes are made that affect a particular window, the WM marks that window as invalid. The next time the window is redrawn (either manually or by a callback routine) it will be validated.

### **Window coordinates**

Window coordinates are coordinates of a window. The upper left position (the origin) of the window is (0,0).

### **Z-position, bottom/top**

Although a window is displayed on a two-dimensional screen in terms of X and Y, the WM also manages what is known as a Z-position, or depth coordinate—a position in a virtual third dimension which determines its placement from background to foreground. Windows can therefore appear on top of or beneath one another.

Setting a window to the bottom will place it “underneath” all of its sibling windows (if any); setting it to the top will place it “on top of” its siblings. When a window is created, it is set to the top by default if no create flag is specified.

## 6.1.2 Callback mechanism, invalidation, rendering and keyboard input

The idea behind the callback mechanism that emWin offers for windows and window objects (widgets) is that of an event-driven system. As in most windowing systems, the principle is that the flow of control is not just from the user program to the graphic system, but also from the user program to the graphic system and back up to the user program by means of the callback routines provided by the user program. This mechanism—often facetiously referred to as the Hollywood principle (“Don’t call us, we’ll call you!”)—is needed by the Window Manager mainly in order to trigger the redrawing of windows. This contrasts with classical programming, but it makes it possible to exploit the invalidation logic of the Window Manager.

### 6.1.2.1 Rendering using callbacks

In order to create a window with a callback, you must have a callback routine. The routine is used as part of the `WM_CreateWindow()` function when creating the window (the `cb` parameter). All callback routines must have the following prototype:

#### Prototype

```
void Callback(WM_MESSAGE * pMsg);
```

| Parameter         | Description   |
|-------------------|---|
| <code>pMsg</code> | Pointer to a data structure of type <code>WM_MESSAGE</code> . |

The action performed by the callback routine depends on the type of message it receives. The prototype above is usually followed by a switch statement, which defines different behaviors for different messages using one or more case statements (typically at least `WM_PAINT`).

#### Processing the `WM_PAINT` message

When a window receives a `WM_PAINT` message, it should repaint itself. Before sending this message to the window, the WM makes sure it is selected. **A non-transparent window (default!) has to repaint its entire invalid area.** The easiest way is to repaint the entire area of the window. The clipping mechanism of the WM makes sure that only the invalid area will be redrawn. In order to accelerate the drawing process, it can make sense to only repaint the invalid area. How to get the invalid area is described later in this chapter (Information is part of the message).

**A transparent window** on the other hand does not have to redraw the entire invalid area; it can leave the window area partially untouched. This untouched area will then be transparent.

Before the WM sends a `WM_PAINT` message to a transparent window, the area below has been redrawn (by sending a `WM_PAINT` message to the window(s) below).

#### Note

Do not draw outside of `WM_PAINT`!

The messages `WM_PAINT`, `WM_PRE_PAINT` and `WM_POST_PAINT` should only process drawing operations.

When processing the `WM_PAINT` message, the callback routine should do nothing but redrawing the contents of the window. When processing the `WM_PAINT`, `WM_PRE_PAINT` or `WM_POST_PAINT` event, the following functions may not be called: `WM_SelectWindow()`, `WM_Paint()`, `WM_DeleteWindow()` and `WM_CreateWindow()`. Also any other functions which changes the properties of a window may not be called: `WM_Move()`, `WM_Resize()`, ...

## Example

Creates a callback routine to automatically redraw a window:

```
void WinHandler(WM_MESSAGE * pMsg) {
    switch (pMsg->MsgId) {
        case WM_PAINT:
            GUI_SetBkColor(0xFF00);
            GUI_Clear();
            GUI_DispStringAt("Hello world",0,0);
            break;
        default:
            WM_DefaultProc(pMsg);
    }
}
```

The messages WM\_PRE\_PAINT and WM\_POST\_PAINT are sent directly before and after the WM\_PAINT messages are processed.

### 6.1.2.2 Overwriting callback functions

The default behavior of widgets and windows in emWin is defined in their callback functions. If the behavior of a widget has to be changed, or if the functionality of a window needs to be enhanced to meet custom needs, it is recommended to overwrite the internal callback function. This is done in a few simple steps:

#### Step 1: Creating a custom callback function

The first step is to implement a function using the following prototype:

```
void Callback(WM_MESSAGE * pMsg);
```

#### Step 2: Messages

The second step is to implement a reaction to certain messages.

Since custom callback functions do not need to handle all possible messages, it is recommended to make use of a `switch / case` condition. This makes it possible to easily add or remove one message specific code, without affecting another. The parameter `pMsg` contains the Id of the message (`pMsg->MsgId`). A complete list of messages handled by the Window Manager may be reviewed under *Message IDs* on page 969.

#### Step 3: Processing the default callback

The third step is to make sure all messages which are not handled by the custom callback function, are handled by the internal (default) callback function. The recommended way to do this is to use the default case of the `switch / case` condition to call the internal callback function.

Internal callback functions are different for each type of window. The internal callback functions for widgets are named `<WIDGET>_Callback()`. All other types of windows use the function `WM_DefaultProc()` for message handling.

```
switch (pMsg->MsgId) {
    case WM_CREATE:
        .
        .
        .
        break;
    case WM_PAINT:
        .
        .
        .
        break;
    case WM_SIZE:
        .
        .
        .
```

```

        .
        break;
    default:
        <WIDGET>_Callback(pMsg);
    }

```

#### Step 4: Setting the custom callback function to be used

The last step to do is setting the newly created callback function to be used by a window or widget. This is done with a simple call of `WM_SetCallback()`. Detailed information can be found under `WM_SetCallback` on page 899.

### 6.1.2.3 Background window redrawing and callback

During initialization of the Window Manager, a window containing the whole LCD area is created as a background window. The handle of this window is `WM_HBKWIN`. The WM does not redraw areas of the background window automatically, because there is no default background color. That means if you create a further window and then delete it, the deleted window will still be visible. The routine `WM_SetDesktopColor()` needs to be specified in order to set a color for redrawing the background window.

You can also set a callback function to take care of this problem. If a window is created and then deleted as before, the callback routine will trigger the WM to recognize that the background window is no longer valid and redraw it automatically. For more information on using a callback routine to redraw the background, see the example at the end of the chapter.

### 6.1.2.4 Invalidation

Invalidation of a window or a part of it tells the WM that the invalid area of the window should be redrawn the next time `GUI_Exec()` or `GUI_Delay()` is called. The invalidation routines of `emWin` do not redraw the invalid part of a window. They only manage the invalid areas of the windows.

#### The invalid area of a window

The WM uses just one rectangle per window to store the smallest rectangle containing the entire invalid area. If for example a small part in the upper left corner and a small part in the lower right corner becomes invalid, the complete window is invalidated.

#### Why using invalidation

The advantage of using window invalidation in opposite of drawing each window immediately is that the window will be drawn only one time even if it is invalidated more than one time. If for example several properties of a window need to be changed (for example the background color, the font and the size of the window) it takes more time to draw the window immediately after each property has been changed than drawing the window only one time after all properties have been changed.

#### Redrawing of invalid windows

The function `GUI_Exec()` redraws all invalid windows. This is done by sending one or more `WM_PAINT` messages to each invalid window.

### 6.1.2.5 Tiling mechanism

Until here it should be clear, that drawing of a window normally is done by sending a `WM_PAINT` message. But if a window is partly covered by a child window or any other window, it is very important to know that it receives more than one `WM_PAINT` message. The WM cuts the non covered area of the window to be drawn into a number of sub rectangles. During that process it sets the clipping area to each of the rectangular areas and sends a single `WM_PAINT` message for each of the rectangles to the window. The more fragmented the window area is, the more rectangles exist and the more messages are send. Because of that the `WM_PAINT` handler should not do time consuming calculations.

The sample below shows the tiling mechanism required for drawing the background window covered by a `FRAMEWINDOW` widget. The widget consists of 2 windows, the main window and the client area. The main window is a transparent window which is drawn on top of the background and has no effect on the tiling algorithm whereas the client area is opaque and causes tiling of the background. The WM generates tiles around the client area from the top to the bottom and from the left to the right. The tiling algorithm implies that the number of tiles increases with the number of covered areas.

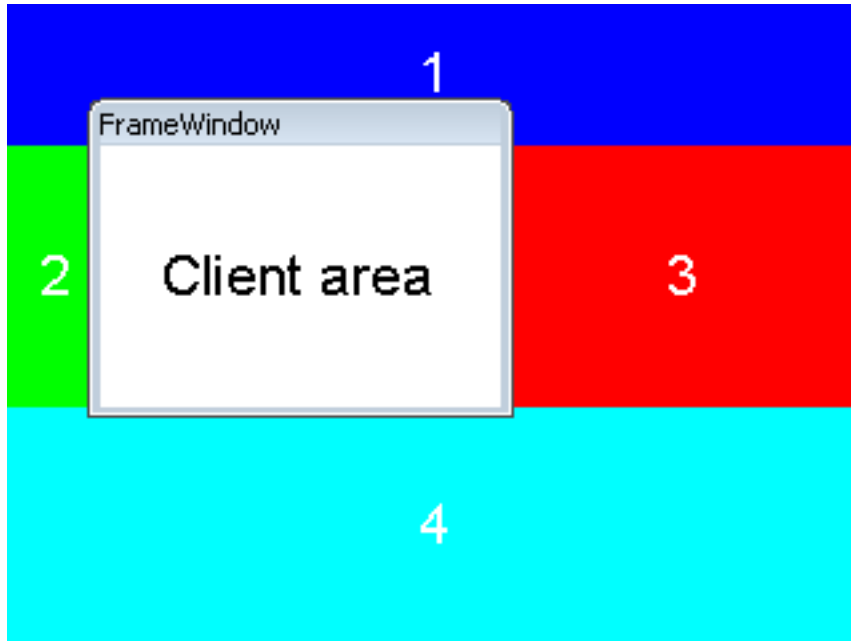

The screenshot below shows the above sample with an additional small window at the bottom right edge. When starting the drawing process of a non transparent window the WM first sends a `WM_PRE_PAINT` message. After that the window receives a `WM_PAINT` message for each tile. And after drawing the last tile the WM sends a final `WM_POST_PAINT` message. The more areas covering a non transparent window the more tiles are required for drawing the window.



### Drawing without tiling

Under some circumstances it may could make sense to suppress tiling. That could be achieved by using the flag `WM_CF_LATE_CLIP` explained later in this chapter.



### 6.1.2.6 Rendering of transparent windows

If a transparent window needs to be drawn, the WM automatically makes sure, that the background of the window is drawn before the transparent window receives a `WM_PAINT` message. This is done by redrawing all window areas below the invalid area of the transparent window first before sending a `WM_PAINT` message to the transparent window.

To make sure the Window Manager can handle the redrawing of transparent windows it is necessary to redraw the window in reaction to the `WM_PAINT` message. Otherwise it can not be guaranteed that the appearance of a transparent window will be correctly.

The use of transparent windows is more CPU-intensive than the use of non transparent windows. If performance is a problem, trying to avoid transparent windows may be an option.

### 6.1.2.7 Automatic use of Memory Devices

The default behavior of the Window Manager is sending a `WM_PAINT` message to each window which needs to be redrawn. This can cause flickering effects. To suppress these 'per window' flickering effects Memory Devices can be used automatically for the drawing operation. This can be achieved by setting the flag `WM_CF_MEMDEV` when creating the window, by setting the default creation flags with `WM_SetCreateFlags()` or by using the function `WM_EnableMemdev()`. The WM then redirects the output of the `WM_PAINT` message into a Memory Device which is copied to the display once the actual drawing was performed. If not enough memory for the whole window is available banding is used automatically. The according Memory Device is created internally just before the `WM_PAINT` message is sent and is removed immediately after the drawing is finished.

In case a transparent window should be drawn, the below area will also be drawn into the Memory Device.

Detailed information about Memory Devices can be found in the chapter *Memory Devices* on page 2626.

### 6.1.2.8 Automatic use of multiple frame buffers

The WM is able to use automatically multiple frame buffers if they are available. This can be achieved by the function `WM_MULTIBUF_Enable()`. If enabled the Window Manager redirects the output of all drawing functions to the invisible back buffer before it draws the invalid windows. After the last invalid window has been drawn the WM makes the back buffer visible. This feature is available only if the display driver supports multiple buffers and if there is enough RAM to store at least 2 frame buffers. More information can be found in the chapter *Multiple Buffering* on page 712.

### 6.1.2.9 Automatic use of display driver cache

The WM automatically uses the display driver cache if available. If available it locks the buffer before it starts to draw the invalid windows. After the last window has been drawn the WM unlocks the cache.

### 6.1.2.10 Keyboard input

The Window Manager handles keyboard input automatically. It polls the keyboard buffer and sends according keyboard messages to the currently focused window. The keyboard buffer can be filled using the function `GUI_StoreKeyMsg()`.

## 6.1.3 Motion support

Motion support enables the ability to move windows by gestures. It can be used with any pointer input device (PID) like a touch screen, a mouse or a joystick. If motion support is enabled the respective window can be put into movement simply with a gesture. After releasing the PID the movement is decelerated within a specified period. Movement operations can be also initiated by API functions instead of gestures.

### 6.1.3.1 Enabling motion support of the WM

First of all motion support needs to be enabled before it can be used. This can be done by calling the function `WM_MOTION_Enable()` once. Without calling this function once the motion support functions will not work.

### 6.1.3.2 Basic motion support for a window

To be able to use motion support for a window it needs to be enabled for each window which should be movable. In case of a movable parent window with several child windows motion support needs only be enabled for the parent window. There are 2 possibilities to achieve basic motion support for a window:

#### 6.1.3.2.1 Using creation flags

To achieve movability for a window it can be created with one or more or-combined creation flags. The following table shows the available creation flags:

| Flag                        | Description  |
|-----------------------------|--|
| <code>WM_CF_MOTION_R</code> | Enables circular movability for objects within the window. |
| <code>WM_CF_MOTION_X</code> | Enables movability for the X axis.                         |
| <code>WM_CF_MOTION_Y</code> | Enables movability for the Y axis.                         |

#### Example

```
WM_HWIN hWin;
hWin = WM_CreateWindowAsChild(0, 0, 40, 40, hParent,
    WM_CF_SHOW | WM_CF_MOTION_X | WM_CF_MOTION_Y, cbWin, 0);
```

#### Note

Of course the motion flags can also be used with widget creation functions.

#### 6.1.3.2.2 Using API function

To achieve movability for a window after it has been created without movability flags the function `WM_MOTION_SetMoveable()` explained later in this chapter can be used.

### 6.1.3.3 Motion processing by application

The easiest way to achieve movable windows is setting up basic motion support. The WM then automatically moves the window when dragging the PID. But in certain situations it could make sense to process the motion information by the application instead of moving the whole window. That makes it possible to move any kind of content within a window, achieving edge snapping, overlapping or circular moves. In order to make use of that kind of advanced motion features the callback function of the movable window has to be adapted. In case the WM recognizes PID movement it sends a `WM_MOTION` message to the window. In order to achieve advanced motion support an appropriate reaction to the `WM_MOTION` message needs to be implemented.

### 6.1.3.3.1 WM\_MOTION message and WM\_MOTION\_INFO

As explained in the message description *WM\_MOTION* on page 816 the *Data.p* element of the *WM\_MOTION* message points to a *WM\_MOTION\_INFO* structure. The element *Cmd* of this structure contains information about the current operation. The following table shows the possible values of the element *Cmd*:

| Flag             | Description   |
|------------------|---|
| WM_MOTION_INIT   | Sent to a window to initiate a motion operation.              |
| WM_MOTION_MOVE   | Sent to a window to achieve custom moving operations.         |
| WM_MOTION_GETPOS | Sent to get the current position of custom moving operations. |

#### WM\_MOTION\_INIT

If a PID move has been detected by the WM it first checks if there is any visible window available under the PID position which is already movable. This makes it possible to achieve moving operations for windows which are partially or totally covered by child windows. If the WM does not find an already movable window it sends the command to the 'top window' of the PID position.

If the window is not already movable when receiving this command the element *Flags* of the *WM\_MOTION\_INFO* structure can be used to enable motion support. The creation flags explained earlier can be used here to achieve automatic motion support. The *Flags* element simply needs to be OR-combined with the desired flag(s).

#### WM\_MOTION\_INIT and custom motion support

Custom motion support means that the moving operation is not done automatically by the WM but by the callback routine of the window. This can be useful if for example radial motions are required or if the content of a window should be moved instead of the window itself. To achieve custom motion support the *Flags* element needs to be OR-combined with the flag *WM\_MOTION\_MANAGE\_BY\_WINDOW*.

#### WM\_MOTION\_MOVE

Sent to a window with custom motion support enabled. The elements *dx* and *dy* of the *WM\_MOTION\_INFO* structure can be used to achieve the custom moving operation.

#### WM\_MOTION\_GETPOS

Sent to a window with custom motion support enabled. The task of the callback routine here is returning the current position. This needs to be done with the elements *xPos* and *yPos* of the *WM\_MOTION\_INFO* structure.

#### Snapping

The elements *SnapX* and *SnapY* of the *WM\_MOTION\_INFO* structure can be used to achieve snapping. These values determine a kind of grid for snapping. This means that the deceleration of the movement operation will stop exactly on a grid position. Also if there currently is no movement and the window is only released it will snap into the next grid position.

#### Overlapping

Overlapping means a short distance a window/object could be moved beyond its boundary. When releasing the PID it will move to its boundary automatically. The element *Overlap* of the *WM\_MOTION\_INFO* structure can be used to achieve overlapping. It is recommended to use at maximum the half of the snapping distance.

#### Examples

Several samples in the tutorial folder show how to achieve overlapping, snapping, circular moves and how to use advanced motion support.

### 6.1.3.4 Motion support for circular moves

That kind of motion support can be used to turn items around the center of a window. Windows can not be rotated. To enable support for circular moves the flag `WM_CF_MOTION_R` should be used which should be set within the `WM_MOTION_INIT` message. Moving the items need to be managed by the application. Because of that also the flag `WM_MOTION_MANAGE_BY_WINDOW` explained earlier must be set. The values in 1/10 degrees to be used are passed to the application in the element `da` of the `WM_MOTION_INFO` structure available within the message `WM_MOTION_MOVE`. The KNOB widget for example is completely based on motion support for circular moves.

#### Example

```
static void _OnMotion(WM_HWIN hWin, WM_MOTION_INFO * pInfo) {
    ...
    switch (pInfo->Cmd) {
    case WM_MOTION_INIT:
        pInfo->Flags = WM_CF_MOTION_R | WM_MOTION_MANAGE_BY_WINDOW;
        break;
    case WM_MOTION_MOVE:
        _DoMotion(hObj, pInfo->da);
        break;
    ...
    }
}
```

### 6.1.3.5 Widgets with motion support

Some of the widgets provide motion support which can be enabled by calling `<WIDGET>_EnableMotion()`.

If needed, an overlapping value in pixels can also be set by calling `<WIDGET>_SetOverlap()`. The overlapping value is the distance in pixels that the user can drag the content above the start and end position.

| Widget                                     | Routine                               |
|--|---------------------------------------|
| <code>&lt;WIDGET&gt;_EnableMotion()</code> |                                       |
| DROPDOWN                                   | <code>DROPDOWN_EnableMotion()</code>  |
| LISTBOX                                    | <code>LISTBOX_EnableMotion()</code>   |
| LISTVIEW                                   | <code>LISTVIEW_EnableMotion()</code>  |
| MULTIEDIT                                  | <code>MULTIEDIT_EnableMotion()</code> |
| SWIPELIST                                  | <i>None, motion is always active.</i> |
| <code>&lt;WIDGET&gt;_SetOverlap()</code>   |                                       |
| SWIPELIST                                  | <code>SWIPELIST_SetOverlap()</code>   |

## 6.1.4 Window manager and multiple layers

A hardware with multiple layers offers a range of new possibilities. This subchapter should give some guidelines and explain the most important pitfalls. We highly recommend to consider the following rules.

### 6.1.4.1 Drawing operations

One of the most important recommendations is using the invalidation mechanism of the window manager for drawing operations. If something should be drawn in a further layer a window with callback function should be used and the drawing operation should be done within `WM_PAINT`.

#### Note

Do **not** draw outside of a `WM_PAINT` message! It can lead to unexpected behavior.

On the first glance it often looks easy to use `GUI_SelectLayer()` and draw something outside of the current window in a different layer. But please note that this most often leads in unexpected behavior of the GUI. Multiple buffering, clipping and calculation of invalid state could fail in that case, even if it seems to work on the first glance.

### 6.1.4.2 Window relationship

A child window must be created in the same layer as its parent window. The WM won't work as expected if that rule is not observed. `WM_CreateWindow()` currently does not fail in that case, but the WM does not work correctly if the parent window is in a different layer than its child window.

### 6.1.4.3 Semi-transparency

Most LCD controllers with multiple layers support an alpha channel for semi transparency effects. That requires an alpha value in the alpha channel of the frame buffer after executing a drawing operation. Please note that the default behavior of `emWin` is using the given alpha values (for example of an PNG image) for mixing up the current background with the foreground and not leaving any alpha values. The function `GUI_PreserveTrans()` should be used before/after those drawing operations. The same applies for drawing anti-aliased text.

### 6.1.4.4 Touch input

Within a multiple layer application it could make sense to have touch sensitive widgets in more than one layer. But the touch pad does not 'know' something about different layers. The normal behavior is setting the element `Layer` of the `GUI_PID_STATE` structure within the touch ISR. The used value should be the layer index containing the touch sensitive widgets.

If it is required to manage touch input in different layers a callback function could be set with `GUI_PID_SetHook()`. That callback function is called immediately before a `GUI_PID_STATE` element is added to the input buffer. Dependent on the coordinates the application could change the `Layer` element. Please note that it is not required to change the coordinates. This is done by the WM automatically.

### 6.1.4.5 Memory devices

Currently a memory device which should be drawn in a `WM_PAINT` event, needs to be created in the same layer as the window which should draw the memory device.

## 6.1.5 ToolTips

A ToolTip in emWin is a small window with one line of text, which appears in conjunction with a pointer input device (PID), usually a mouse. The user hovers the PID over a 'tool', without clicking it, and a small ToolTip window with information about the item being hovered over may appear. After a short time the window disappears automatically. ToolTips make sense for active elements like any kind of button or similar widgets/windows, which can be used as tool for changing something. But they can be used with any kind of window.

### 6.1.5.1 How they work

A ToolTip belongs to a particular parent (or grandparent) window. When the PID hovers over a tool window without any motion, after a specified time (`PERIOD_FIRST`) the ToolTip window occurs. If the PID remains over the tool without motion, the ToolTip automatically disappears after a specified period of no motion (`PERIOD_SHOW`). It remains until the PID does not move for this period. If the PID is clicked or hovers out of the tool window the ToolTip disappears. If the PID remains in the parent area and the PID then hovers again over a tool of the same parent, the ToolTip occurs immediately after a very short period (`PERIOD_NEXT`) of no motion. If the PID moves out of the parent area, the next time a ToolTip occurs is again after `PERIOD_FIRST`. Appearance and timing can be configured at runtime.

### 6.1.5.2 Creating ToolTips

#### Note

The functions and structures mentioned in the following are described in detail later in this chapter under *ToolTip related functions* on page 935.

The function `WM_TOOLTIP_Create()` should be used for creating a ToolTip object. It requires a handle to the parent (or grand parent) window. Optional a pointer to an array of `TOOLTIP_INFO` structures can be passed which is used for adding the desired tools to the ToolTip object. These structures should contain the IDs of the tools and the text to be shown. Alternatively the function `WM_TOOLTIP_AddTool()` can be used to add the tools. This makes sense if the tool window does not have an Id.

#### 6.1.5.2.1 Creating ToolTips for dialog items

As mentioned above the `TOOLTIP_INFO` structure is used to address the desired tools by its IDs. Because the items of a dialog normally have an Id this is quite easy.

#### Example

The following example shows how it works:

```
#include "DIALOG.h"
#define ID_BUTTON_0 (GUI_ID_USER + 0x01)
#define ID_BUTTON_1 (GUI_ID_USER + 0x02)
static const GUI_WIDGET_CREATE_INFO _aDialogCreate[] = {
    { FRAMEWIN_CreateIndirect, "Framewin", 0, 0, 0, 320, 240, 0, 0, 0 },
    { BUTTON_CreateIndirect, "Button 0", ID_BUTTON_0, 5, 5, 80, 20, 0, 0, 0 },
    { BUTTON_CreateIndirect, "Button 1", ID_BUTTON_1, 5, 30, 80, 20, 0, 0, 0 },
};
static const TOOLTIP_INFO _aInfo[] = {
    { ID_BUTTON_0, "I am Button 0" },
    { ID_BUTTON_1, "I am Button 1" },
};
static void _ShowDialog(void) {
    WM_HWIN hWin;
    WM_TOOLTIP_HANDLE hInfo;
    hWin = GUI_CreateDialogBox(_aDialogCreate, GUI_COUNTOF(_aDialogCreate), 0,
                              WM_HBKWIN, 0, 0);
    hInfo = WM_TOOLTIP_Create(hWin, _aInfo, GUI_COUNTOF(_aInfo));
}
```

```

while (1) {
    GUI_Delay(100);
}
}

```

### 6.1.5.2.2 Creating ToolTips for simple windows

Because simple windows normally do not have an Id, there exists a function for adding tools without using IDs. The function `WM_TOOLTIP_AddTool()` can be used to do this by passing the tool window handle and the required text to be shown.

#### Example

The following example shows how it works:

```

#include <stddef.h>
#include "WM.h"
static void _cbParent(WM_MESSAGE * pMsg) {
    switch (pMsg->MsgId) {
        case WM_PAINT:
            GUI_SetBkColor(GUI_BLUE);
            GUI_Clear();
            GUI_DispString("Parent window");
            break;
    }
}
static void _cbTool(WM_MESSAGE * pMsg) {
    switch (pMsg->MsgId) {
        case WM_PAINT:
            GUI_SetBkColor(GUI_RED);
            GUI_Clear();
            GUI_DispString("Tool window");
            break;
    }
}
void MainTask(void) {
    WM_HWIN hTool, hParent;
    WM_TOOLTIP_HANDLE hToolTip;

    GUI_Init();
    WM_SetDesktopColor(GUI_BLACK);
    hParent = WM_CreateWindow(0, 0, 200, 100, WM_CF_SHOW, _cbParent, 0);
    hTool
    = WM_CreateWindowAsChild(20, 20, 100, 50, hParent, WM_CF_SHOW, _cbTool, 0);
    hToolTip = WM_TOOLTIP_Create(hParent, NULL, 0);
    WM_TOOLTIP_AddTool(hToolTip, hTool, "I am a ToolTip");
    while (1) {
        GUI_Delay(100);
    }
}

```

## 6.1.6 Messages

The following section shows which system messages are used by emWin, how to use the message data and how to use application defined messages.

### 6.1.6.1 Message structure

When a callback routine is called, it receives the message specified as its `pMsg` parameter. This message is actually a `WM_MESSAGE` data structure, a full description of the structure can be read under `WM_MESSAGE` on page 964.

### 6.1.6.2 List of messages

#### Note

A full list of messages sent by emWin can be found under *Message IDs* on page 969.

### 6.1.6.3 System-defined messages

These kind of messages are sent by the GUI library. Do not send system defined messages from the user application to a window or a widget.

#### 6.1.6.3.1 WM\_CREATE

##### Description

This message is sent immediately after a window has been created, giving the window the chance to initialize and create any child windows.

##### Data

This message contains no data.

#### 6.1.6.3.2 WM\_DELETE

##### Description

This message is sent just before a window is deleted, telling the window to free its data structures (if any).

##### Data

This message contains no data.

#### 6.1.6.3.3 WM\_GET\_ID

##### Description

This message is sent to a window to request its Id. All emWin widgets handle this message. Application defined windows should handle this message in their callback routine. Otherwise this message will be ignored.

##### Data

The callback routine of the window should store the Id in the `Data.v` value.

#### 6.1.6.3.4 WM\_GET\_INSIDE\_RECT

##### Description

This message is sent to a window to receive the client rectangle without the effect size. The effect size which is typically 0-3 pixels (2 pixels with the standard 3D effect).



## Data

The `Data.p` pointer of the messages points to a `GUI_RECT` structure which has to be filled with the proper coordinates of the client rectangle.

### 6.1.6.3.5 WM\_INIT\_DIALOG

#### Description

This message is sent to a window immediately after the creation of the dialog and before the dialog is displayed. Dialog procedures typically use this message to initialize widgets and carry out any other initialization tasks that affect the appearance of the dialog box.

#### Data

This message contains no data.

### 6.1.6.3.6 WM\_KEY

#### Description

Sent to the window currently containing the focus if a key has been pressed.

#### Data

The `Data.p` pointer of the message points to a `WM_KEY_INFO` structure.

### 6.1.6.3.7 WM\_MOVE

#### Description

This message is sent to a window immediately after it has been moved. If the window has any child windows, they will be moved first. Also each child window will receive this message after it has been moved. The message is sent regardless if the window is visible or not.

#### Data

The `Data.p` pointer of the message points to a `WM_MOVE_INFO` structure.

### 6.1.6.3.8 WM\_NOTIFY\_PARENT

#### Description

Informs a parent window that something has occurred in one of its child window. These messages are typically sent by widgets to their parent windows to give them a chance to react on the event.

#### Data

The `Data.v` value of the message contains the notification code of the message. For more information about the notification codes, refer to the appropriate widget.

### 6.1.6.3.9 WM\_NOTIFY\_VIS\_CHANGED

#### Description

This message is sent to a window if its visibility is changed and the configuration switch `WM_SUPPORT_NOTIFY_VIS_CHANGED` is set to 1. The visibility of a window changes if

- obstruction changes: The window is partially or totally covered or uncovered by a higher level window (a window which is displayed on top of the window),
- the window is deleted or
- the window changes from not hidden to hidden or reverse.

## Typical application

Applications which show a video in a window using a hardware decoder. The hardware decoder can write directly into the display, bypassing emWin, if the window containing the video is completely visible. If the visibility changes, the hardware decoder needs to be reprogrammed.

## Example

The following shows a typical reaction on this message:

```
case WM_NOTIFY_VIS_CHANGED:
    if (WM_IsCompletelyVisible(WM_GetClientWindow(pMsg->hWin))) {
        ...
    }
```

The `Sample` folder of emWin contains the example `WM_Video.c` which shows how to use the message.

## Data

This message contains no data.

### 6.1.6.3.10 WM\_PAINT

#### Description

The WM sends this message to a window if it has become invalid (partially or complete) and needs to be drawn. When a window receives a `WM_PAINT` message, it should repaint itself. Before sending this message to the window, the WM makes sure it is selected. More details about how to react on the `WM_PAINT` message is described earlier in this chapter under *Callback mechanism, invalidation, rendering and keyboard input* on page 801.

#### Data

The `Data.p` pointer of the message points to a `GUI_RECT` structure containing the invalid rectangle of the window in screen coordinates. This information could be used to optimize the paint function.

### 6.1.6.3.11 WM\_POST\_PAINT

#### Description

The WM sends this message to a window right after the last `WM_PAINT` message was processed.

#### Data

This message contains no data.

### 6.1.6.3.12 WM\_PRE\_PAINT

#### Description

The WM sends this message to a window before the first `WM_PAINT` is sent.

#### Data

This message contains no data.

### 6.1.6.3.13 WM\_SET\_CALLBACK

#### Description

The WM sends this message to a window after a callback function has been set.

**Data**

This message contains no data.

**6.1.6.3.14 WM\_SET\_FOCUS****Description**

Sent to a window if it gains or loses the input focus.

**Data**

If the window gains the input focus, the `Data.v` value is set to 1. If the window 'accepts' the input focus, it should set the `Data.v` value to 0 in reaction on this message. If the window loses the input focus, the `Data.v` value is set to 0.

**6.1.6.3.15 WM\_SET\_ID****Description**

Sent to a window to change the Id. All emWin widgets handle this message. Application defined windows should handle this message in their callback routine. Otherwise this message will be ignored.

**Data**

The `Data.v` value contains the new Id of the window.

**6.1.6.3.16 WM\_SIZE****Description**

Sent to a window after its size has changed. Gives the window the chance to reposition its child windows (if any).

**Data**

This message contains no data.

**6.1.6.3.17 WM\_TIMER****Description**

This message will be sent to a window when a timer created by `WM_CreateTimer()` has expired.

**Data**

The `Data.v` value contains the handle of the expired timer.

**6.1.6.3.18 WM\_USER\_DATA****Description**

Sent to a window immediately after `WM_SetUserData()` has been called.

**6.1.6.4 Pointer input device (PID) messages**

These kind of messages are sent by the GUI library in reaction of PID input. Do not send this messages from the user application to a window or a widget.

#### 6.1.6.4.1 WM\_MOTION

##### Description

A `WM_MOTION` message is sent to a window to achieve advanced motion support. It is sent if a pointer input device is moved over a movable window and to initiate a moving operation. Detailed information about Motion Support can be found in the section *Motion support* on page 927.

##### Data

The `Data.p` pointer of the message points to a `WM_MOTION_INFO` structure.

#### 6.1.6.4.2 WM\_MOUSEOVER

##### Description

A `WM_MOUSEOVER` message is sent to a window if a pointer input device touches the outline of a window. It is sent only if mouse support is enabled. This message is not sent to disabled windows.

To enable mouse support, add the following line to the file `GUIConf.h`:

```
#define GUI_SUPPORT_MOUSE 1
```

##### Data

The `Data.p` pointer of the message points to a `GUI_PID_STATE` structure. The structure member `Pressed` is always set to 0 when receiving a `WM_MOUSEOVER` message.

#### 6.1.6.4.3 WM\_MOUSEOVER\_END

##### Description

A `WM_MOUSEOVER_END` message is sent to a window if the mouse pointer has been moved out of the window. It is sent only if mouse support is enabled. This message is not sent to disabled windows.

##### Data

The `Data.p` pointer of the message points to a `GUI_PID_STATE` structure. For details about this structure, refer to the message `WM_MOUSEOVER`.

#### 6.1.6.4.4 WM\_PID\_STATE\_CHANGED

##### Description

Sent to the window affected by the pointer input device when the pressed state has changed. The affected window is the visible window at the input position. With other words: If the user releases for example the touch screen over a window, the pressed state changes from 1 (pressed) to 0 (unpressed). In this case a `WM_PID_STATE_CHANGED` message is sent to the window. This message is sent before the touch message is sent. An invisible window does not receive this message. Transparent windows are handled the same way as visible windows. This message is not sent to disabled windows.

##### Data

The `Data.p` pointer of the message points to a `WM_PID_STATE_CHANGED_INFO` structure.

#### 6.1.6.4.5 WM\_TOUCH

##### Description

A `WM_TOUCH` message is sent to a window once the PID

- is pressed.

- is moved in pressed state.
- is released.

Windows receive this message, if one of the actions above happens over the visible area and if they are not disabled.

If a window should not receive touch messages the create flag `WM_CF_UNTOUCHABLE` can be used. This causes the touch input to be routed to its parent window.

**Data**

The `Data.p` pointer of the message points to a `GUI_PID_STATE` structure. `Data.p = NULL` means that the PID was moved out of bounds in pressed state.

**6.1.6.4.6 WM\_TOUCH\_CHILD**

**Description**

This message is sent to the parent window if the outline of a child window has been touched with a pointer input device in pressed or unpressed state. This message is not sent to disabled windows.

**Data**

The `Data.p` pointer of the message points to the `WM_MESSAGE` sent to the child window. Details about the message data can be found under `WM_TOUCH` on page 816. The message has to be dereferenced twice to get access to the `GUI_PID_STATE` attached to this message.

**Example**

```
//                                     -> WM_TOUCH message           -> GUI_PID_STATE
pState = (GUI_PID_STATE *) ((WM_MESSAGE *) pMsg->Data.p)->Data.p;
```

**6.1.6.4.7 Example**

The following example explains what happens if a pointer input device is dragged over a dialog with a button:

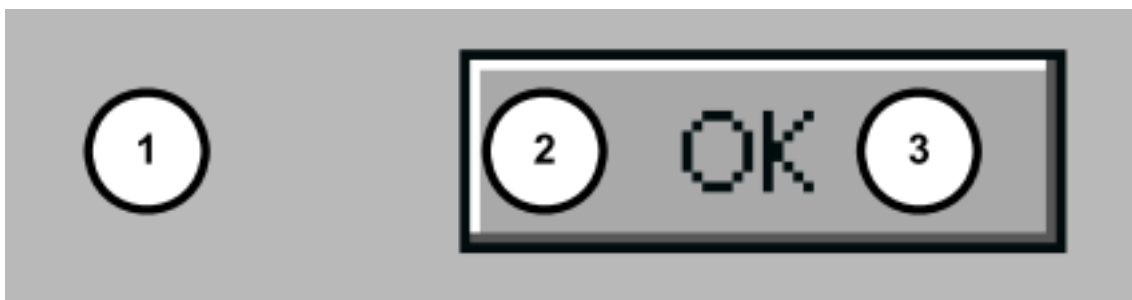

| Position | Description  |
|----------|--|
| 1        | <p>The pointer input device (PID) is pressed at this position. This causes the WM to send the following <code>WM_PID_STATE_CHANGED</code> message to the window at this position:<br/>                     x = Horizontal position in desktop coordinates.<br/>                     y = Vertical position in desktop coordinates.<br/>                     State = 1<br/>                     StatePrev = 0</p> <p>The WM also sends a <code>WM_TOUCH</code> message with the same x and y coordinates to the window:<br/>                     x = Horizontal position in desktop coordinates.<br/>                     y = Vertical position in desktop coordinates.<br/>                     Pressed = 1</p> |
| 2        | <p>The PID is dragged to this position. The window below (the button) will receive no <code>WM_PID_STATE_CHANGED</code> message, because the PID remains in pressed state.<br/>                     The WM only sends a <code>WM_TOUCH</code> message to the window:<br/>                     x = Horizontal position in desktop coordinates.<br/>                     y = Vertical position in desktop coordinates.<br/>                     Pressed = 1</p>  |

| Position | Description  |
|----------|--|
| 3        | <p>The PID is released at this position. This causes the WM to send the following WM_PID_STATE_CHANGED message to the window at this position:</p> <p>x = Horizontal position in desktop coordinates.<br/> y = Vertical position in desktop coordinates.<br/> State = 0<br/> StatePrev = 1</p> <p>The WM also sends a WM_TOUCH message with the same x and y coordinates to the window:</p> <p>x = Horizontal position in desktop coordinates.<br/> y = Vertical position in desktop coordinates.<br/> Pressed = 0</p> |

### 6.1.6.5 System-defined notification codes

A message of this type is sent from a window to its parent window to notify it of a change in the child window. This gives the parent window the chance to react on this event. The message contains a `hWinSrc` element which is a handle to the widget which caused the message. Detailed information about which notification messages are utilized by a widget can be found in the according Widget description in the chapter *Widgets (window objects)* on page 982.

#### Note

Do not send system defined notification codes from the user application to a window.

A full list of notification codes can be found under *Notification codes* on page 974.

### 6.1.6.6 Application-defined messages

The application program can define additional messages for its own usage. In order to ensure that they custom message Ids do not equal the Ids which are predefined in `emWin`, user-defined messages start numbering at `WM_USER`. Defining custom messages is recommended as follows:

```
#define MY_MESSAGE_AAA (WM_USER + 0)
#define MY_MESSAGE_BBB (WM_USER + 1)
```

## 6.1.7 Configuration options

| Type | Macro                         | Default | Description   |
|------|-------------------------------|---------|---|
| B    | WM_SUPPORT_NOTIFY_VIS_CHANGED | 0       | Enables the WM to send a WM_NOTIFY_VIS_CHANGED message to a window if its visibility is changed.                  |
| B    | WM_SUPPORT_TRANSPARENCY       | 1       | Enable support for transparent windows. If set to 0 the additional code for transparency support is not included. |

### 6.1.7.1 WM\_SUPPORT\_NOTIFY\_VIS\_CHANGED

Per default emWin does not inform windows if their visibility has changed. If enabled, the WM sends WM\_NOTIFY\_VIS\_CHANGED messages.

### 6.1.7.2 WM\_SUPPORT\_TRANSPARENCY

Per default emWin supports transparent windows. This means per default the additional code used to handle transparent windows is linked if the WM is used. If the application does not use transparent windows the memory requirement of the application can be reduced if WM\_SUPPORT\_TRANSPARENCY is set to 0.

## 6.1.8 WM API

The following table lists the available routines of the emWin Window Manager API. All functions are listed in alphabetical order within their respective categories. Detailed descriptions of the routines can be found later in the chapter.

### Functions

| Routine                               | Description  |
|---------------------------------------|--|
| Basic functions                       |  |
| <code>WM_Activate()</code>            | Activates the Window Manager.  |
| <code>WM_AttachWindow()</code>        | Attaches a window to a new parent window.  |
| <code>WM_AttachWindowAt()</code>      | Attaches a window to a new parent window at the given position.                        |
| <code>WM_BroadcastMessage()</code>    | Sends the given message to all existing windows.                                       |
| <code>WM_BringToBottom()</code>       | Places a specified window underneath its siblings.                                     |
| <code>WM_BringToTop()</code>          | Places a specified window on top of its siblings.                                      |
| <code>WM_ClrHasTrans()</code>         | Clears the <code>has transparency</code> flag (sets it to 0).                          |
| <code>WM_CreateWindow()</code>        | Creates a window.  |
| <code>WM_CreateWindowAsChild()</code> | Creates a window as a child window.  |
| <code>WM_Deactivate()</code>          | Deactivates the Window Manager.  |
| <code>WM_DefaultProc()</code>         | Default message handler.   |
| <code>WM_DeleteWindow()</code>        | Deletes a specified window.  |
| <code>WM_DeleteWindowSecure()</code>  | Deletes a window safely.   |
| <code>WM_DetachWindow()</code>        | Detaches a window from its parent window.  |
| <code>WM_DisableWindow()</code>       | Disables the specified window.   |
| <code>WM_EnableWindow()</code>        | Sets the specified window to enabled state.  |
| <code>WM_Exec()</code>                | Redraws invalid windows by executing callbacks (all jobs).                             |
| <code>WM_Exec1()</code>               | Redraws one invalid window by executing one callback (one job only).                   |
| <code>WM_ForEachDesc()</code>         | Iterates over all descendants of the given window.                                     |
| <code>WM_GetActiveWindow()</code>     | Returns handle of the active window.   |
| <code>WM_GetCallback()</code>         | Returns a pointer to the callback function of the given window.                        |
| <code>WM_GetClientRect()</code>       | Returns the coordinates of the client area in the active window in window coordinates. |
| <code>WM_GetClientRectEx()</code>     | Returns the coordinates of the client area of a window in window coordinates.          |
| <code>WM_GetDesktopWindow()</code>    | Returns the handle of the desktop window.  |
| <code>WM_GetDesktopWindowEx()</code>  | Returns the window handle of the specified desktop window.                             |
| <code>WM_GetDialogItem()</code>       | Returns the window handle of a dialog box item (widget).                               |
| <code>WM_GetFirstChild()</code>       | Returns the handle of a specified window's first child window.                         |
| <code>WM_GetFocusedWindow()</code>    | Returns the handle of the window with the input focus.                                 |



| Routine                                | Description  |
|--|--|
| <code>WM_GetHasTrans()</code>          | Returns the current value of the has transparency flag.                |
| <code>WM_GetInvalidRect()</code>       | Returns the invalid rectangle of a window in desktop coordinates.      |
| <code>WM_GetModalLayer()</code>        | Returns the current modal layer.                                       |
| <code>WM_GetModalWindow()</code>       | Returns the modal window.  |
| <code>WM_GetNextSibling()</code>       | Returns the handle of a specified window's next sibling.               |
| <code>WM_GetNumInvalidWindows()</code> | Returns the number of currently invalid windows.                       |
| <code>WM_GetOrgX()</code>              | Returns the origin in X of the active window.                          |
| <code>WM_GetOrgY()</code>              | Returns the origin in Y of the active window.                          |
| <code>WM_GetParent()</code>            | Returns the handle of a specified window's parent window.              |
| <code>WM_GetPrevSibling()</code>       | Returns the handle of a specified window's previous sibling.           |
| <code>WM_GetStayOnTop()</code>         | Returns the current value of the stay on top flag.                     |
| <code>WM_GetUserData()</code>          | Retrieves the data set with <code>WM_SetUserData()</code> .            |
| <code>WM_GetWindowOrgX()</code>        | Returns the origin in X of a window.                                   |
| <code>WM_GetWindowOrgY()</code>        | Returns the origin in Y of a window.                                   |
| <code>WM_GetWindowRect()</code>        | Returns the coordinates of the active window in desktop coordinates.   |
| <code>WM_GetWindowRectEx()</code>      | Returns the coordinates of a window in desktop coordinates.            |
| <code>WM_GetWindowSizeX()</code>       | Return the X-size of a specified window.                               |
| <code>WM_GetWindowSizeY()</code>       | Return the Y-size of a specified window.                               |
| <code>WM_HasCaptured()</code>          | Checks if the given window has captured PID input.                     |
| <code>WM_HasFocus()</code>             | Checks if the given window has the input focus.                        |
| <code>WM_HideWindow()</code>           | Makes a specified window invisible.                                    |
| <code>WM_InvalidateArea()</code>       | Invalidates a certain section of the display.                          |
| <code>WM_InvalidateRect()</code>       | Invalidates a part of a window.  |
| <code>WM_InvalidateWindow()</code>     | Invalidates a window.  |
| <code>WM_IsCompletelyCovered()</code>  | Checks if the given window is completely covered or not.               |
| <code>WM_IsCompletelyVisible()</code>  | Checks if the given window is completely visible or not.               |
| <code>WM_IsEnabled()</code>            | This function returns if a window is enabled or not.                   |
| <code>WM_IsUntouchable()</code>        | Returns whether the given window has the un-touchable flag set.        |
| <code>WM_IsVisible()</code>            | Determines whether or not a specified window is visible.               |
| <code>WM_IsWindow()</code>             | Determines whether or not a specified handle is a valid window handle. |
| <code>WM_MakeModal()</code>            | This function makes the window work in 'modal' mode.                   |
| <code>WM_MoveChildTo()</code>          | Sets the position of a window in window coordinates.                   |

| Routine                               | Description  |
|---------------------------------------|--|
| <code>WM_MoveTo()</code>              | Sets the position of a window in desktop coordinates.  |
| <code>WM_MoveWindow()</code>          | Moves a window to another position.  |
| <code>WM_NotifyParent()</code>        | Sends a <code>WM_NOTIFY_PARENT</code> message to the given window.   |
| <code>WM_Paint()</code>               | Draws or redraws a specified window immediately.   |
| <code>WM_PaintWindowAndDescs()</code> | Draws a given window and all descendant windows immediately.   |
| <code>WM_ReleaseCapture()</code>      | Releases capturing of mouse- and touch-screen-input.   |
| <code>WM_ResizeWindow()</code>        | Changes the size of a specified window by adding (or subtracting) the given differences.                         |
| <code>WM_Rect2Screen()</code>         | Converts the given rectangle holding coordinates relative to the given window into screen positions.             |
| <code>WM_Rect2Client()</code>         | Converts the given rectangle holding coordinates relative to the screen into coordinates relative to the window. |
| <code>WM_Screen2hWin()</code>         | Returns the window which lies at the specified position.   |
| <code>WM_Screen2hWinEx()</code>       | Returns the window which lies at the specified position.   |
| <code>WM_SelectWindow()</code>        | Selects a window to be used for drawing operations.  |
| <code>WM_SendMessage()</code>         | Sends a message to a specified window.   |
| <code>WM_SendMessageNoPara()</code>   | Sends a message without parameters to a specified window.  |
| <code>WM_SendToParent()</code>        | Sends the given message to the parent window of the given window.  |
| <code>WM_SetCallback()</code>         | Sets a callback routine to be executed by the Window Manager.  |
| <code>WM_SetCapture()</code>          | Routes all PID-messages to the given window.   |
| <code>WM_SetCaptureMove()</code>      | Moves a window according to the given PID state.   |
| <code>WM_SetCreateFlags()</code>      | Sets the flags to be used as default when creating a new window.   |
| <code>WM_SetDesktopColor()</code>     | Sets the color for the desktop window.   |
| <code>WM_SetDesktopColorEx()</code>   | Sets the color for the desktop window in a multi layer environment.  |
| <code>WM_SetEnableState()</code>      | Sets the window to an enabled or disabled state.   |
| <code>WM_SetFocus()</code>            | Sets the input focus to a specified window.  |
| <code>WM_SetHasTrans()</code>         | Enables transparency for the given window.   |
| <code>WM_SetId()</code>               | This function sends a <code>WM_SET_ID</code> message to the given window.  |
| <code>WM_SetModalLayer()</code>       | Sets the layer to be used as modal layer.  |
| <code>WM_SetpfPollPID()</code>        | Sets a function to be called by the WM for polling the PID.  |
| <code>WM_SetSize()</code>             | Sets the new size of a window.   |

| Routine                                    | Description   |
|--|---|
| <code>WM_SetUntouchable()</code>           | This function makes a window 'untouchable'.   |
| <code>WM_SetWindowPos()</code>             | Sets the size and the position of a window.   |
| <code>WM_SetXSize()</code>                 | Sets the new X-size of a window.  |
| <code>WM_SetYSize()</code>                 | Sets the new Y-size of a window.  |
| <code>WM_SetStayOnTop()</code>             | Sets the stay on top flag.  |
| <code>WM_SetTransState()</code>            | This function sets or clears the flags <code>WM_CF_HAS-TRANS</code> and <code>WM_CF_CONST_OUTLINE</code> of the given window. |
| <code>WM_SetUserClipRect()</code>          | Reduces the clipping area temporarily.  |
| <code>WM_SetUserData()</code>              | Sets the extra data of a window.  |
| <code>WM_ShowWindow()</code>               | Makes a specified window visible.   |
| <code>WM_Update()</code>                   | Draws the invalid part of the specified window immediately.   |
| <code>WM_UpdateWindowAndDescs()</code>     | Draws the invalid part of a given window and the invalid part of all descendant windows.                                      |
| <code>WM_ValidateRect()</code>             | Validates parts of a window.  |
| <code>WM_ValidateWindow()</code>           | Validates a window.   |
| <code>WM_XY2Screen()</code>                | Converts window coordinate into screen coordinates.   |
| <code>WM_XY2Client()</code>                | Converts screen coordinates into window coordinates.  |
| <b>Motion support</b>                      |   |
| <code>WM_MOTION_Enable()</code>            | Enables motion support for the WM.  |
| <code>WM_MOTION_SetDeceleration()</code>   | Sets the deceleration for the current movement.   |
| <code>WM_MOTION_SetDefaultPeriod()</code>  | Sets the default period for movements.  |
| <code>WM_MOTION_SetMotion()</code>         | Sets speed and deceleration for the desired movement.   |
| <code>WM_MOTION_SetMoveable()</code>       | Sets movability flags for the given window.   |
| <code>WM_MOTION_SetMovement()</code>       | Sets speed and distance for the desired movement.   |
| <code>WM_MOTION_SetSpeed()</code>          | Sets the speed for the desired movement.  |
| <code>WM_MOTION_SetThreshold()</code>      | Sets the minimum distance required for starting a move.   |
| <b>ToolTip related functions</b>           |   |
| <code>WM_TOOLTIP_AddTool()</code>          | Adds a tool to an existing ToolTip object.  |
| <code>WM_TOOLTIP_Create()</code>           | Creates a ToolTip object for the given dialog.  |
| <code>WM_TOOLTIP_Delete()</code>           | Deletes the given ToolTip object.   |
| <code>WM_TOOLTIP_SetDefaultColor()</code>  | Sets the default colors to be used for drawing ToolTips.  |
| <code>WM_TOOLTIP_SetDefaultFont()</code>   | Sets the font to be used for displaying the text of ToolTips.   |
| <code>WM_TOOLTIP_SetDefaultPeriod()</code> | Sets the default periods to be used for showing ToolTips.   |
| <b>Multiple Buffering support</b>          |   |
| <code>WM_MULTIBUF_Enable()</code>          | This functions enables or disables the automatic use of Multiple Buffering by the Window Manager.                             |

| Routine                            | Description  |
|------------------------------------|--|
| Memory Device support (optional)   |  |
| <code>WM_DisableMemdev()</code>    | Disables the use of Memory Devices for redrawing a window.               |
| <code>WM_EnableMemdev()</code>     | Enables the use of Memory Devices for redrawing a window.                |
| Timer related                      |  |
| <code>WM_CreateTimer()</code>      | Creates a timer which sends a <code>WM_TIMER</code> message to a window. |
| <code>WM_DeleteTimer()</code>      | Deletes the given timer.   |
| <code>WM_GetTimerId()</code>       | Gets the Id of the given timer.  |
| <code>WM_RestartTimer()</code>     | Restarts the given timer with the given period.                          |
| Widget related functions           |  |
| <code>WM_GetClientWindow()</code>  | Returns the handle of the client window.                                 |
| <code>WM_GetContentRect()</code>   | Returns the content rectangle of the current window.                     |
| <code>WM_GetContentRectEx()</code> | Returns the content rectangle of a given window.                         |
| <code>WM_GetId()</code>            | Returns the ID of a widget.  |
| <code>WM_GetInsideRect()</code>    | Returns the size of the active window less the border.                   |
| <code>WM_GetInsideRectEx()</code>  | Returns the size of a window less the border.                            |
| <code>WM_GetScrollbarH()</code>    | Returns the handle of an attached horizontal scroll bar.                 |
| <code>WM_GetScrollbarV()</code>    | Returns the handle of an attached vertical scroll bar.                   |
| <code>WM_GetScrollPosH()</code>    | Returns the horizontal scroll position of a window.                      |
| <code>WM_GetScrollPosV()</code>    | Returns the vertical scroll position of a window.                        |
| <code>WM_GetScrollState()</code>   | Gets the state of a <code>SCROLLBAR</code> widget.                       |
| <code>WM_SetScrollPosH()</code>    | Sets the horizontal scrolling position of a window.                      |
| <code>WM_SetScrollPosV()</code>    | Sets the vertical scrolling position of a window.                        |
| <code>WM_SetScrollState()</code>   | Sets the state of a specified <code>SCROLLBAR</code> widget.             |

## Data structures

| Structure                              | Description  |
|--|--|
| <code>TOOLTIP_INFO</code>              | Contains the information about a ToolTip.              |
| <code>WM_KEY_INFO</code>               | Contains information about a pressed key.              |
| <code>WM_MESSAGE</code>                | Contains the data for a message sent by a window.      |
| <code>WM_MOTION_INFO</code>            | Contains information about a move with motion support. |
| <code>WM_MOVE_INFO</code>              | Stores the distance of a window move operation.        |
| <code>WM_PID_STATE_CHANGED_INFO</code> | Information about the changed PID state.               |
| <code>WM_SCROLL_STATE</code>           | Saves the scrollstate of a scrollbar.                  |

## Defines

| Group of defines                       | Description  |
|--|--|
| <a href="#">Message IDs</a>            | List of all messages sent by the Window Manager.           |
| <a href="#">Motion flags</a>           | Flags for motion support.                                  |
| <a href="#">Motion messages</a>        | Commands sent with a WM_MOTION message.                    |
| <a href="#">Notification codes</a>     | List of all notification codes sent with WM_NOTIFY_PARENT. |
| <a href="#">ToolTip color indexes</a>  | Color indexes for ToolTip related routines.                |
| <a href="#">ToolTip period indexes</a> | Period indexes for ToolTip related routines.               |
| <a href="#">Window create flags</a>    | Flags that define a window upon creation.                  |

### 6.1.8.1 Using the WM API functions

Many of the WM functions have window handles as parameters. Observe the following rules when using handles:

- Window handles can be 0. In this case functions usually return immediately. Functions which do not follow this rule are described accordingly.
- If a window handle is  $\neq 0$ , it should be a valid handle. The WM does not check if the given handle is valid. If an invalid handle is given to a function it fails or may even cause the application to crash.

## 6.1.8.2 Basic functions

### 6.1.8.2.1 WM\_Activate()

#### Description

Activates the Window Manager.

#### Prototype

```
void WM_Activate(void);
```

#### Additional information

The WM is activated by default after initialization. This function only needs to be called if there has been a previous call of `WM_Deactivate()`.

### 6.1.8.2.2 WM\_AttachWindow()

#### Description

The given window will be detached from its parent window and attached to the new parent window. The new origin in window coordinates of the new parent window will be the same as the old origin in window coordinates of the old parent window.

#### Prototype

```
void WM_AttachWindow(WM_HWIN hWin,  
                    WM_HWIN hParent);
```

#### Parameters

| Parameter               | Description                      |
|-------------------------|----------------------------------|
| <code>hWin</code>       | Window handle.                   |
| <code>hWinParent</code> | Window handle of the new parent. |

#### Additional information

If the given window handle is 0 or both handles are the same the function returns immediately.

If only the given parent window handle is 0 the function detaches the given window and returns; the window remains unattached.

### 6.1.8.2.3 WM\_AttachWindowAt()

#### Description

The given window will be detached from its parent window and attached to the new parent window. The given position will be used to set the origin of the window in window coordinates of the parent window.

#### Prototype

```
void WM_AttachWindowAt(WM_HWIN hWin,  
                      WM_HWIN hParent,  
                      int      x,  
                      int      y);
```

#### Parameters

| Parameter               | Description  |
|-------------------------|--|
| <code>hWin</code>       | Window handle.   |
| <code>hWinParent</code> | Window handle of the new parent.                                     |
| <code>x</code>          | X position of the window in window coordinates of the parent window. |
| <code>y</code>          | Y position of the window in window coordinates of the parent window. |

#### Additional information

If the given window handle is 0 or both handles are the same the function returns immediately.

If only the given parent window handle is 0 the function detaches the given window, moves it to the new position and returns; the window remains unattached.



#### 6.1.8.2.4 WM\_BringToBottom()

##### Description

Places a specified window underneath its siblings.

##### Prototype

```
void WM_BringToBottom(WM_HWIN hWin);
```

##### Parameters

| Parameter         | Description    |
|-------------------|----------------|
| <code>hWin</code> | Window handle. |

##### Additional information

The window will be placed underneath all other sibling windows, but will remain in front of its parent.

### 6.1.8.2.5 WM\_BringToTop()

#### Description

Places a specified window on top of its siblings.

#### Prototype

```
void WM_BringToTop(WM_HWIN hWin);
```

#### Parameters

| Parameter         | Description    |
|-------------------|----------------|
| <code>hWin</code> | Window handle. |

#### Additional information

The window will be placed on top of all other sibling windows and its parent.

### 6.1.8.2.6 WM\_BroadcastMessage()

#### Description

Sends the given message to all existing windows.

#### Prototype

```
int WM_BroadcastMessage(WM_MESSAGE * pMsg);
```

#### Parameters

| Parameter         | Description                                  |
|-------------------|--|
| <code>pMsg</code> | Pointer to the message structure to be sent. |

#### Return value

Returns 0.

#### Additional information

A window should not delete itself or a parent window in reaction of a broadcasted message.

### 6.1.8.2.7 WM\_ClrHasTrans()

#### Description

Clears the `has transparency` flag (sets it to 0).

#### Prototype

```
void WM_ClrHasTrans(WM_HWIN hWin);
```

#### Parameters

| Parameter         | Description    |
|-------------------|----------------|
| <code>hWin</code> | Window handle. |

#### Additional information

When set, this flag tells the Window Manager that a window contains sections which are not redrawn and will therefore be transparent. The WM then knows that the back-ground needs to be redrawn prior to redrawing the window in order to make sure the transparent sections are restored correctly.

When the flag is cleared with `WM_ClrHasTrans()`, the WM will not automatically redraw the background before redrawing the window.

### 6.1.8.2.8 WM\_CreateWindow()

#### Description

Creates a window of a specified size at a specified location.

#### Prototype

```
WM_HWIN WM_CreateWindow(int          x0,
                        int          y0,
                        int          width,
                        int          height,
                        U32          Style,
                        WM_CALLBACK * cb,
                        int          NumExtraBytes);
```

#### Parameters

| Parameter                  | Description  |
|----------------------------|--|
| <code>x0</code>            | Upper left X-position in desktop coordinates.  |
| <code>y0</code>            | Upper left Y-position in desktop coordinates.  |
| <code>width</code>         | X-size of window.  |
| <code>height</code>        | Y-size of window.  |
| <code>Style</code>         | Window create flags which are OR-combinable. See a full list under <i>Window create flags</i> on page 977. |
| <code>cb</code>            | Pointer to callback routine, or NULL if no callback used.  |
| <code>NumExtraBytes</code> | Number of extra bytes to be allocated, normally 0.   |

#### Return value

Handle to the created window.

#### Additional information

Several create flags can be combined by using the OR operator. Negative-position coordinates may be used.

#### Examples

Creates a window with callback:

```
hWin2 = WM_CreateWindow(100, 10, 180, 100, WM_CF_SHOW, &_cbWin, 0);
```

Creates a window without callback:

```
hWin2 = WM_CreateWindow(100, 10, 180, 100, WM_CF_SHOW, NULL, 0);
```

### 6.1.8.2.9 WM\_CreateWindowAsChild()

#### Description

Creates a window as a child window.

#### Prototype

```
WM_HWIN WM_CreateWindowAsChild(int          x0,
                                int          y0,
                                int          width,
                                int          height,
                                WM_HWIN     hParent,
                                U32         Style,
                                WM_CALLBACK * cb,
                                int          NumExtraBytes);
```

#### Parameters

| Parameter                  | Description  |
|----------------------------|--|
| <code>x0</code>            | Upper left X-position in window coordinates of the parent window.      |
| <code>y0</code>            | Upper left Y-position in window coordinates of the parent window.      |
| <code>width</code>         | X-size of window. If 0, X-size of client area of parent window.        |
| <code>height</code>        | Y-size of window. If 0, Y-size of client area of parent window.        |
| <code>hWinParent</code>    | Handle of parent window.   |
| <code>Style</code>         | Window create flags (see <i>Window create flags</i> on page 977).      |
| <code>cb</code>            | Pointer to callback routine, or <code>NULL</code> if no callback used. |
| <code>NumExtraBytes</code> | Number of extra bytes to be allocated, normally 0.                     |

#### Return value

Handle to the created window.

#### Additional information

If the `hWinParent` parameter is set to 0, the background window is used as parent. A child window is placed on top of its parent and any previous siblings by default, so that if their Z-positions are not changed, the “youngest” window will always be topmost.

The Z-positions of siblings may be changed, although they will always remain on top of their parent regardless of their order.

### 6.1.8.2.10 WM\_Deactivate()

#### Description

Deactivates the Window Manager.

#### Prototype

```
void WM_Deactivate(void);
```

#### Additional information

After calling this function, the clip area is set to the complete LCD area and the WM will not execute window callback functions.

### 6.1.8.2.11 WM\_DefaultProc()

#### Description

Default message handler.

#### Prototype

```
void WM_DefaultProc(WM_MESSAGE * pMsg);
```

#### Parameters

| Parameter         | Description         |
|-------------------|---------------------|
| <code>pMsg</code> | Pointer to message. |

#### Additional information

Use this function to handle unprocessed messages as in the following example:

```
static WM_RESULT cbBackgroundWin(WM_MESSAGE * pMsg) {  
    switch (pMsg->MsgId) {  
        case WM_PAINT:  
            GUI_Clear();  
            break;  
        default:  
            WM_DefaultProc(pMsg);  
    }  
}
```



### 6.1.8.2.12 WM\_DeleteWindow()

#### Description

Deletes a specified window.

#### Prototype

```
void WM_DeleteWindow(WM_HWIN hWin);
```

#### Parameters

| Parameter         | Description    |
|-------------------|----------------|
| <code>hWin</code> | Window handle. |

#### Additional information

Before the window is deleted, it receives a `WM_DELETE` message. This message is typically used to delete any objects (widgets) it uses and to free memory dynamically allocated by the window.

If the specified window has any existing child windows, these are automatically deleted before the window itself is deleted. Child windows therefore do not need to be separately deleted.

Before the window will be deleted it sends a `WM_NOTIFICATION_CHILD_DELETED` message to its parent window.

### 6.1.8.2.13 WM\_DeleteWindowSecure()

#### Description

Deletes a window safely. The window is deleted upon the next execution of `GUI_Exec()`. This routine should be used if e.g. a window should be deleted within its callback.

#### Prototype

```
void WM_DeleteWindowSecure(WM_HWIN hWin);
```

#### Parameters

| Parameter         | Description    |
|-------------------|----------------|
| <code>hWin</code> | Window handle. |

### 6.1.8.2.14 WM\_DetachWindow()

#### Description

Detaches a window from its parent window. Detached windows will not be redrawn by the Window Manager.

#### Prototype

```
void WM_DetachWindow(WM_HWIN hWin);
```

#### Parameters

| Parameter         | Description    |
|-------------------|----------------|
| <code>hWin</code> | Window handle. |

### 6.1.8.2.15 WM\_DisableWindow()

#### Description

Disables the specified window. The WM does not pass user input messages (touch, mouse, joystick, ...) to a disabled window.

#### Prototype

```
void WM_DisableWindow(WM_HWIN hWin);
```

#### Parameters

| Parameter         | Description    |
|-------------------|----------------|
| <code>hWin</code> | Window handle. |

#### Additional information

A widget that is disabled will typically appear gray, and will not accept input from the user. However, the actual appearance may vary (depends on widget/configuration settings, etc.). A disabled window will not receive the following messages: WM\_TOUCH, WM\_TOUCH\_CHILD, WM\_PID\_STATE\_CHANGED and WM\_MOUSEOVER.

### 6.1.8.2.16 WM\_EnableWindow()

#### Description

Sets the specified window to enabled state. An enabled window receives pointer input device (PID) messages (touch, mouse, joystick, ...) from the WM.

#### Prototype

```
void WM_EnableWindow(WM_HWIN hWin);
```

#### Parameters

| Parameter         | Description       |
|-------------------|-------------------|
| <code>hObj</code> | Handle of window. |

#### Additional information

This is the default setting for any widget.

### 6.1.8.2.17 WM\_Exec()

#### Description

This function takes care of handling window related input and redrawing of invalid windows.

#### Prototype

```
int WM_Exec(void);
```

#### Return value

0 if there were no jobs performed (or only one window has been drawn).  
1 if a job was performed.

#### Additional information

This function keeps the WindowManager 'alive'. WM\_Exec() gets also called by GUI\_Exec(). A return value of 0 does not necessarily mean that nothing has been done by the Window Manager. If only one window is invalid and no input has to be processed, WM\_Exec() will return 0 as well.

To check if something has been done, albeit WM\_Exec() returns zero, the function WM\_GetNumInvalidWindows() can be used.

```
r = WM_GetNumInvalidWindows();  
r |= WM_Exec();  
if (r) {  
    // Something has been done  
}
```

In general this function does not need to be called by the user application and it is recommended to call GUI\_Exec() instead. Therefore, it is also called by GUI\_Delay(), which is recommended in a multitasking environment.

### 6.1.8.2.18 WM\_Exec1()

#### Description

This function handles one job. This means, handling either one touch input or one paint event.

#### Prototype

```
int WM_Exec1(void);
```

#### Return value

0        if there were no jobs performed.  
1        if a job was performed.

#### Additional information

This routine may be called repeatedly until 0 is returned, which means all jobs have been completed.

It is recommended to call the function `GUI_Exec1()` instead.

### 6.1.8.2.19 WM\_ForEachDesc()

#### Description

Iterates over all descendants of the given window. A descendant of a window is a child window or a grand child window or a child of a grand child and so on.

#### Prototype

```
void WM_ForEachDesc(WM_HWIN      hWin,
                   WM_tfForEach * pcb,
                   void          * pData);
```

#### Parameters

| Parameter          | Description  |
|--------------------|--|
| <code>hWin</code>  | Window handle.   |
| <code>pcb</code>   | Pointer to callback function to be called by <code>WM_ForEachDesc</code> . |
| <code>pData</code> | User data to be passed to the callback function.                           |

#### Additional information

This function calls the callback function given by the pointer `pcb` for each descendant of the given window. The parameter `pData` will be passed to the user function and can be used to point to user defined data.

#### Prototype of callback function

```
void CallbackFunction(WM_HWIN hWin,
                    void * pData);
```

#### Example

The following example shows how the function can be used. It creates 3 windows, the first as a child window of the desktop, the second as a child window of the first window and the third as a child window of the second window. After creating the window it uses `WM_ForEachDesc()` to move each window within its parent window:

```
static void _cbWin(WM_MESSAGE * pMsg) {
    GUI_COLOR Color;
    switch (pMsg->MsgId) {
        case WM_PAINT:
            WM_GetUserData(pMsg->hWin, &Color, 4);
            GUI_SetBkColor(Color);
            GUI_Clear();
            break;
        default:
            WM_DefaultProc(pMsg);
    }
}
static void _cbDoSomething(WM_HWIN hWin, void * p) {
    int Value = *(int *)p;
    WM_MoveWindow(hWin, Value, Value);
}
void MainTask(void) {
    WM_HWIN hWin_1, hWin_2, hWin_3;
    int Value = 10;
    GUI_COLOR aColor[] = {GUI_RED, GUI_GREEN, GUI_BLUE};
    GUI_Init();
    WM_SetDesktopColor(GUI_BLACK);
    hWin_1 = WM_CreateWindow( 10, 10, 100, 100, WM_CF_SHOW, _cbWin, 4);
    hWin_2 = WM_CreateWindowAsChild(10, 10, 80, 80, hWin_1, WM_CF_SHOW, _cbWin, 4);
    hWin_3 = WM_CreateWindowAsChild(10, 10, 60, 60, hWin_2, WM_CF_SHOW, _cbWin, 4);
    WM_SetUserData(hWin_1, &aColor[0], 4);
    WM_SetUserData(hWin_2, &aColor[1], 4);
}
```



```
WM_SetUserData(hWin_3, &aColor[2], 4);  
while(1) {  
    WM_ForEachDesc(WM_HBKWIN, _cbDoSomething, (void *)&Value);  
    Value *= -1;  
    GUI_Delay(500);  
}
```

### 6.1.8.2.20 WM\_GetActiveWindow()

#### Description

Returns the handle of the active window used for drawing operations.

#### Prototype

```
WM_HWIN WM_GetActiveWindow(void);
```

#### Return value

The handle of the active window.

#### Additional information

This function should be used only when the message WM\_PAINT is processed in a window callback function.

### 6.1.8.2.21 WM\_GetCallback()

#### Description

Returns a pointer to the callback function of the given window.

#### Prototype

```
WM_CALLBACK *WM_GetCallback(WM_HWIN hWin);
```

#### Parameters

| Parameter         | Description    |
|-------------------|----------------|
| <code>hWin</code> | Window handle. |

#### Additional information

Pointer of type `WM_CALLBACK` which points to the callback function of the given window. If the window has no callback function, `NULL` is returned.

### 6.1.8.2.22 WM\_GetClientRect()

#### Description

Returns the coordinates of the client area in the active window in window coordinates. That means x0 and y0 of the `GUI_RECT` structure will be 0, x1 and y1 corresponds to the size - 1.

#### Prototype

```
void WM_GetClientRect(GUI_RECT * pRect);
```

#### Parameters

| Parameter          | Description                                   |
|--------------------|---|
| <code>pRect</code> | Pointer to a <code>GUI_RECT</code> structure. |

### 6.1.8.2.23 WM\_GetClientRectEx()

#### Description

Returns the coordinates of the client area of a window in window coordinates. That means x0 and y0 of the `GUI_RECT` structure will be 0, x1 and y1 corresponds to the size - 1.

#### Prototype

```
void WM_GetClientRectEx(WM_HWIN    hWin,  
                       GUI_RECT * pRect);
```

#### Parameters

| Parameter          | Description                                   |
|--------------------|---|
| <code>hWin</code>  | Window handle.                                |
| <code>pRect</code> | Pointer to a <code>GUI_RECT</code> structure. |

#### 6.1.8.2.24 WM\_GetDesktopWindow()

##### Description

Returns the handle of the desktop window.

##### Prototype

```
WM_HWIN WM_GetDesktopWindow(void);
```

##### Return value

The handle of the desktop window.

##### Additional information

The desktop window is always the bottommost window and any further created windows are its descendants.

### 6.1.8.2.25 WM\_GetDesktopWindowEx()

#### Description

Returns the handle of the specified desktop window when working in a multi layer environment.

#### Prototype

```
WM_HWIN WM_GetDesktopWindowEx(unsigned int LayerIndex);
```

#### Parameters

| Parameter                  | Description     |
|----------------------------|-----------------|
| <a href="#">LayerIndex</a> | Index of layer. |

#### Return value

The handle of the specified desktop window.

### 6.1.8.2.26 WM\_GetDialogItem()

#### Description

Returns the window handle of a dialog box item (widget).

#### Prototype

```
WM_HWIN WM_GetDialogItem(WM_HWIN hWin,  
                          int Id);
```

#### Parameters

| Parameter            | Description                           |
|----------------------|---------------------------------------|
| <code>hDialog</code> | Parent handle of the widget.          |
| <code>Id</code>      | Window <code>Id</code> of the widget. |

#### Return value

The window handle of the widget.

#### Additional information

This function is always used when creating dialog boxes, since the window `Id` of a widget used in a dialog must be converted to its handle before it can be used.



### 6.1.8.2.27 WM\_GetFirstChild()

#### Description

Returns the handle of a specified window's first child window.

#### Prototype

```
WM_HWIN WM_GetFirstChild(WM_HWIN hWin);
```

#### Parameters

| Parameter            | Description    |
|----------------------|----------------|
| <a href="#">hWin</a> | Window handle. |

#### Return value

Handle of the window's first child window; 0 if no child window exists.

#### Additional information

A window's first child window is the first child created to that particular parent. If the Z-positions of the windows have not been changed, it will be the window directly on top of the specified parent.

### 6.1.8.2.28 WM\_GetFocusedWindow()

#### Description

Returns the handle of the window with the input focus.

#### Prototype

```
WM_HWIN WM_GetFocusedWindow(void);
```

#### Return value

Handle of the window with the input focus or 0 if no window has the input focus.

### 6.1.8.2.29 WM\_GetHasTrans()

#### Description

Returns the current value of the has transparency flag.

#### Prototype

```
int WM_GetHasTrans(WM_HWIN hWin);
```

#### Parameters

| Parameter         | Description    |
|-------------------|----------------|
| <code>hWin</code> | Window handle. |

#### Return value

0        no transparency  
1        window has transparency

#### Additional information

When set, this flag tells the Window Manager that a window contains sections which are not redrawn and will therefore be transparent. The WM then knows that the background needs to be redrawn prior to redrawing the window in order to make sure the transparent sections are restored correctly.

### 6.1.8.2.30 WM\_GetInvalidRect()

#### Description

Returns the invalid rectangle of a window in desktop coordinates.

#### Prototype

```
int WM_GetInvalidRect(WM_HWIN    hWin,  
                    GUI_RECT * pRect);
```

#### Parameters

| Parameter          | Description  |
|--------------------|--|
| <code>hWin</code>  | Window handle.   |
| <code>pRect</code> | Pointer to a GUI_RECT-structure for storing the invalid rectangle. |

#### Return value

0        if nothing is invalid.  
1        otherwise.

### 6.1.8.2.31 WM\_GetModalLayer()

#### Description

Returns the current modal layer. Per default there does not exist a modal layer. In that case the function returns -1.

#### Prototype

```
int WM_GetModalLayer(void);
```

#### Return value

$\geq 0$       Index of current modal layer.  
= -1        No modal layer is used.

#### Additional information

Additional information can be found in the description of `WM_SetModalLayer()`.

### 6.1.8.2.32 WM\_GetModalWindow()

#### Description

Returns the modal window.

#### Prototype

```
WM_HWIN WM_GetModalWindow(void);
```

#### Return value

= 0      If there is no modal window.  
≠ 0      Handle of the modal window.

### 6.1.8.2.33 WM\_GetNextSibling()

#### Description

Returns the handle of a specified window's next sibling.

#### Prototype

```
WM_HWIN WM_GetNextSibling(WM_HWIN hWin);
```

#### Parameters

| Parameter            | Description    |
|----------------------|----------------|
| <a href="#">hWin</a> | Window handle. |

#### Return value

Handle of the window's next sibling.  
0 if none exists.

#### Additional information

A window's next sibling is the next child window that was created relative to the same parent. If the Z-positions of the windows have not been changed, it will be the window directly on top of the one specified.

### 6.1.8.2.34 WM\_GetNumInvalidWindows()

#### Description

Returns the number of currently invalid windows.

#### Prototype

```
int WM_GetNumInvalidWindows(void);
```

#### Return value

Number of invalid windows.



### 6.1.8.2.35 WM\_GetOrgX()

### 6.1.8.2.36 WM\_GetOrgY()

#### Description

Returns the X- or Y-position (respectively) of the origin of the active window in desktop coordinates.

#### Prototypes

```
int WM_GetOrgX(void);
```

```
int WM_GetOrgY(void);
```

#### Return value

X- or Y-position of the origin of the active window in desktop coordinates.

### 6.1.8.2.37 WM\_GetParent()

#### Description

Returns the handle of a specified window's parent window.

#### Prototype

```
WM_HWIN WM_GetParent(WM_HWIN hWin);
```

#### Parameters

| Parameter            | Description    |
|----------------------|----------------|
| <a href="#">hWin</a> | Window handle. |

#### Return value

Handle of the window's parent window.  
0 if none exists.

#### Additional information

The only case in which no parent window exists is if the handle of the desktop window is used as parameter.

### 6.1.8.2.38 WM\_GetPrevSibling()

#### Description

Returns the handle of a specified window's previous sibling.

#### Prototype

```
WM_HWIN WM_GetPrevSibling(WM_HWIN hWin);
```

#### Parameters

| Parameter         | Description    |
|-------------------|----------------|
| <code>hWin</code> | Window handle. |

#### Return value

Handle of the window's previous sibling.  
0 if none exists.

#### Additional information

A window's previous sibling is the previous child window that was created relative to the same parent. If the Z-positions of the windows have not been changed, it will be the window directly below of the one specified.

### 6.1.8.2.39 WM\_GetStayOnTop()

#### Description

Returns the current value of the stay on top flag.

#### Prototype

```
int WM_GetStayOnTop(WM_HWIN hWin);
```

#### Parameters

| Parameter         | Description    |
|-------------------|----------------|
| <code>hWin</code> | Window handle. |

#### Return value

0 stay on top flag not set  
1 stay on top flag set

### 6.1.8.2.40 WM\_GetUserData()

#### Description

Retrieves the data set with WM\_SetUserData().

#### Prototype

```
int WM_GetUserData(WM_HWIN hWin,  
                  void * pDest,  
                  int NumBytes);
```

#### Parameters

| Parameter                 | Description        |
|---------------------------|--------------------|
| <code>hWin</code>         | Window handle.     |
| <code>pDest</code>        | Pointer to buffer. |
| <code>SizeOfBuffer</code> | Size of buffer.    |

#### Return value

≠ 0      Number of bytes retrieved.  
= 0      If the given handle is `NULL`.

#### Additional information

The maximum number of bytes returned by this function is the number of `ExtraBytes` specified when creating the window.

### 6.1.8.2.41 WM\_GetWindowOrgX()

### 6.1.8.2.42 WM\_GetWindowOrgY()

#### Description

Returns the X- or Y-position (respectively) of the origin of the specified window in desktop coordinates.

#### Prototypes

```
int WM_GetWindowOrgX(WM_HWIN hWin);
```

```
int WM_GetWindowOrgY(WM_HWIN hWin);
```

#### Parameters

| Parameter         | Description    |
|-------------------|----------------|
| <code>hWin</code> | Window handle. |

#### Return value

X- or Y-position of the client area in pixels.

### 6.1.8.2.43 WM\_GetWindowRect()

#### Description

Returns the coordinates of the active window in desktop coordinates.

#### Prototype

```
void WM_GetWindowRect(GUI_RECT * pRect);
```

#### Parameters

| Parameter          | Description                      |
|--------------------|----------------------------------|
| <code>pRect</code> | Pointer to a GUI_RECT structure. |

### 6.1.8.2.44 WM\_GetWindowRectEx()

#### Description

Returns the coordinates of a window in desktop coordinates.

#### Prototype

```
void WM_GetWindowRectEx(WM_HWIN    hWin,  
                        GUI_RECT * pRect);
```

#### Parameters

| Parameter          | Description                                   |
|--------------------|---|
| <code>hWin</code>  | Window handle.                                |
| <code>pRect</code> | Pointer to a <code>GUI_RECT</code> structure. |

#### Additional information

If the given window handle is 0 or the given pointer to the `GUI_RECT` structure is `NULL` the function returns immediately.



#### 6.1.8.2.45 WM\_GetWindowSizeX()

#### 6.1.8.2.46 WM\_GetWindowSizeY()

##### Description

Return the X- or Y-size (respectively) of a specified window.

##### Prototypes

```
int WM_GetWindowSizeX(WM_HWIN hWin);
```

```
int WM_GetWindowSizeY(WM_HWIN hWin);
```

##### Parameters

| Parameter         | Description    |
|-------------------|----------------|
| <code>hWin</code> | Window handle. |

##### Return value

X- or Y-size of the window in pixels.

Defined as  $x_1 - x_0 + 1$  in horizontal direction,  $y_1 - y_0 + 1$  in vertical direction, where  $x_0$ ,  $x_1$ ,  $y_0$ ,  $y_1$  are the leftmost/rightmost/topmost/bottommost positions of the window. If the given window handle is 0 the function returns the size of the desktop window.

### 6.1.8.2.47 WM\_HasCaptured()

#### Description

Checks if the given window has captured PID input.

#### Prototype

```
int WM_HasCaptured(WM_HWIN hWin);
```

#### Parameters

| Parameter         | Description    |
|-------------------|----------------|
| <code>hWin</code> | Window handle. |

#### Return value

1 if the given window has captured mouse- and touchscreen-input.  
0 if not.

#### Additional information

If the given window handle is invalid or 0 the function returns a wrong result.

### 6.1.8.2.48 WM\_HasFocus()

#### Description

Checks if the given window has the input focus.

#### Prototype

```
int WM_HasFocus(WM_HWIN hWin);
```

#### Parameters

| Parameter         | Description    |
|-------------------|----------------|
| <code>hWin</code> | Window handle. |

#### Return value

1 if the given window has the input focus.  
0 if not.

#### Additional information

If the given window handle is invalid or 0 the function returns a wrong result.

### 6.1.8.2.49 WM\_HideWindow()

#### Description

Makes a specified window invisible.

#### Prototype

```
void WM_HideWindow(WM_HWIN hWin);
```

#### Parameters

| Parameter         | Description    |
|-------------------|----------------|
| <code>hWin</code> | Window handle. |

#### Additional information

The window will not immediately appear “invisible” after calling this function. The invalid areas of other windows (areas which appear to lie “behind” the window which should be hidden) will be redrawn when executing `WM_Exec()`. If you need to hide (draw over) a window immediately, you should call `WM_Paint()` to redraw the other windows.

### 6.1.8.2.50 WM\_InvalidateArea()

#### Description

Invalidates a specified, rectangular area of the display.

#### Prototype

```
void WM_InvalidateArea(const GUI_RECT * pRect);
```

#### Parameters

| Parameter          | Description   |
|--------------------|---|
| <code>pRect</code> | Pointer to a GUI_RECT structure with desktop coordinates. |

#### Additional information

Calling this function will tell the WM that the specified area is not updated. This function can be used to invalidate any windows or parts of windows that overlap or intersect the area. The coordinates of the GUI\_RECT structure have to be in desktop coordinates.

### 6.1.8.2.51 WM\_InvalidateRect()

#### Description

Invalidates a specified, rectangular area of a window.

#### Prototype

```
void WM_InvalidateRect(      WM_HWIN    hWin,  
                           const GUI_RECT * pRect);
```

#### Parameters

| Parameter          | Description  |
|--------------------|--|
| <code>hWin</code>  | Window handle.   |
| <code>pRect</code> | Pointer to a <code>GUI_RECT</code> structure with window coordinates of the parent window. |

#### Additional information

Calling this function will tell the WM that the specified area is not updated. The next time the Window Manager is executed so the window is redrawn, the area will be redrawn as well. The `GUI_RECT` structure has to be filled with window coordinates.

### 6.1.8.2.52 WM\_InvalidateWindow()

#### Description

Invalidates a specified window.

#### Prototype

```
void WM_InvalidateWindow(WM_HWIN hWin);
```

#### Parameters

| Parameter         | Description    |
|-------------------|----------------|
| <code>hWin</code> | Window handle. |

#### Additional information

Calling this function tells the WM that the specified window is not updated.

### 6.1.8.2.53 WM\_IsCompletelyCovered()

#### Description

Checks if the given window is completely covered or not.

#### Prototype

```
char WM_IsCompletelyCovered(WM_HWIN hWin);
```

#### Parameters

| Parameter         | Description    |
|-------------------|----------------|
| <code>hWin</code> | Window handle. |

#### Return value

1 if the given window is completely covered.  
0 if not.

#### Additional information

If the given window handle is invalid or 0 the function returns a wrong result.



### 6.1.8.2.54 WM\_IsCompletelyVisible()

#### Description

Checks if the given window is completely visible or not.

#### Prototype

```
char WM_IsCompletelyVisible(WM_HWIN hWin);
```

#### Parameters

| Parameter         | Description    |
|-------------------|----------------|
| <code>hWin</code> | Window handle. |

#### Return value

- 1 if the given window is completely visible.
- 0 if it is clipped at its parents borders.

#### Additional information

If the given window handle is invalid or 0 the function returns a wrong result.

### 6.1.8.2.55 WM\_IsEnabled()

#### Description

This function returns if a window is enabled or not.

#### Prototype

```
int WM_IsEnabled(WM_HWIN hObj);
```

#### Parameters

| Parameter            | Description    |
|----------------------|----------------|
| <a href="#">hObj</a> | Window handle. |

#### Return value

1 if the window is enabled.  
0 if not.

#### Additional information

A widget that is disabled will typically appear gray, and will not accept input from the user. However, the actual appearance may vary (depends on widget/configuration settings, etc.)

### 6.1.8.2.56 WM\_IsUntouchable()

#### Description

Returns whether the given window has the untouchable flag set.

#### Prototype

```
int WM_IsUntouchable(WM_HWIN hWin);
```

#### Parameters

| Parameter         | Description    |
|-------------------|----------------|
| <code>hWin</code> | Window handle. |

#### Return value

- 1 Error.
- 0 Window is not untouchable.
- 1 Window is untouchable.

### 6.1.8.2.57 WM\_IsVisible()

#### Description

Determines whether or not a specified window is visible.

#### Prototype

```
int WM_IsVisible(WM_HWIN hWin);
```

#### Parameters

| Parameter         | Description    |
|-------------------|----------------|
| <code>hWin</code> | Window handle. |

#### Return value

- 0 if the window is not visible.
- 1 if the window is visible.

### 6.1.8.2.58 WM\_IsWindow()

#### Description

Determines whether or not a specified handle is a valid window handle.

#### Prototype

```
int WM_IsWindow(WM_HWIN hWin);
```

#### Parameters

| Parameter         | Description    |
|-------------------|----------------|
| <code>hWin</code> | Window handle. |

#### Return value

- 0 handle is not a valid window handle.
- 1 handle is a valid window handle.

#### Additional information

This function should be used only if absolutely necessary. The more windows exist the more time will be used to evaluate, if the given handle is a window.

### 6.1.8.2.59 WM\_MakeModal()

#### Description

This function makes the window work in 'modal' mode. This means pointer device input will only be sent to the 'modal' window or a child window of it if the input position is within the rectangle of the modal window.

#### Prototype

```
void WM_MakeModal(WM_HWIN hWin);
```

#### Parameters

| Parameter         | Description   |
|-------------------|---|
| <code>hWin</code> | Window handle. 0 removes the modal state from the current modal window. |

### 6.1.8.2.60 WM\_MoveChildTo()

#### Description

Moves a specified window to a certain position.

#### Prototype

```
void WM_MoveChildTo(WM_HWIN hWin,  
                   int      x,  
                   int      y);
```

#### Parameters

| Parameter         | Description  |
|-------------------|--|
| <code>hWin</code> | Window handle.   |
| <code>x</code>    | New X-position in window coordinates of the parent window. |
| <code>y</code>    | New Y-position in window coordinates of the parent window. |

### 6.1.8.2.61 WM\_MoveTo()

#### Description

Moves a specified window to a certain position.

#### Prototype

```
void WM_MoveTo(WM_HWIN hWin,  
               int      x,  
               int      y);
```

#### Parameters

| Parameter         | Description                            |
|-------------------|--|
| <code>hWin</code> | Window handle.                         |
| <code>x</code>    | New X-position in desktop coordinates. |
| <code>y</code>    | New Y-position in desktop coordinates. |



### 6.1.8.2.62 WM\_MoveWindow()

#### Description

Moves a specified window by a certain distance.

#### Prototype

```
void WM_MoveWindow(WM_HWIN hWin,  
                  int dx,  
                  int dy);
```

#### Parameters

| Parameter            | Description                  |
|----------------------|------------------------------|
| <a href="#">hWin</a> | Window handle.               |
| <a href="#">dx</a>   | Horizontal distance to move. |
| <a href="#">dy</a>   | Vertical distance to move.   |

### 6.1.8.2.63 WM\_NotifyParent()

#### Description

Sends a WM\_NOTIFY\_PARENT message to the given window.

#### Prototype

```
void WM_NotifyParent(WM_HWIN hWin,  
                   int Notification);
```

#### Parameters

| Parameter                 | Description                         |
|---------------------------|-------------------------------------|
| <code>hWin</code>         | Window handle.                      |
| <code>Notification</code> | Value to send to the parent window. |

#### Additional information

The `Notification` parameter will be sent in the `Data.v` element of the message. The macro `WM_NOTIFICATION_USER` can be used for defining application defined messages:

```
#define NOTIFICATION_1 (WM_NOTIFICATION_USER + 0)  
#define NOTIFICATION_2 (WM_NOTIFICATION_USER + 1)
```

### 6.1.8.2.64 WM\_Paint()

#### Description

Draws or redraws a specified window immediately.

#### Prototype

```
void WM_Paint(WM_HWIN hWin);
```

#### Parameters

| Parameter         | Description    |
|-------------------|----------------|
| <code>hWin</code> | Window handle. |

#### Additional information

The window is redrawn reflecting all updates made since the last time it was drawn.

### 6.1.8.2.65 WM\_PaintWindowAndDescs()

#### Description

Paints the given window and all its descendants.

#### Prototype

```
void WM_PaintWindowAndDescs(WM_HWIN hWin);
```

#### Parameters

| Parameter         | Description    |
|-------------------|----------------|
| <code>hWin</code> | Window handle. |

#### Additional information

The function draws the complete window regions by invalidating them before drawing.

### 6.1.8.2.66 WM\_Rect2Client()

#### Description

Converts the given rectangle holding coordinates relative to the screen into coordinates relative to the window.

#### Prototype

```
void WM_Rect2Client(WM_HWIN    hWin,  
                  GUI_RECT * pRect);
```

#### Parameters

| Parameter          | Description   |
|--------------------|---|
| <code>hWin</code>  | Window handle.  |
| <code>pRect</code> | Pointer to a rectangle with coordinates relative to the screen. |

### 6.1.8.2.67 WM\_Rect2Screen()

#### Description

Converts the given rectangle holding coordinates relative to the given window into screen positions.

#### Prototype

```
void WM_Rect2Screen(WM_HWIN    hWin,  
                   GUI_RECT * pRect);
```

#### Parameters

| Parameter          | Description   |
|--------------------|---|
| <code>hWin</code>  | Window handle.  |
| <code>pRect</code> | Pointer to a rectangle with coordinates relative to the window. |

#### Additional information

This function is useful when using Memory Devices in combination with windows/widgets, because Memory Device use coordinates relative to the screen.

### 6.1.8.2.68 WM\_ReleaseCapture()

#### Description

Releases capturing of mouse- and touchscreen-input.

#### Prototype

```
void WM_ReleaseCapture(void);
```

#### Additional information

Use `WM_SetCapture()` to send all mouse- and touchscreen-input to a specific window.

### 6.1.8.2.69 WM\_ResizeWindow()

#### Description

Changes the size of a specified window by adding (or subtracting) the given differences.

#### Prototype

```
void WM_ResizeWindow(WM_HWIN hWin,  
                    int dx,  
                    int dy);
```

#### Parameters

| Parameter            | Description      |
|----------------------|------------------|
| <a href="#">hWin</a> | Window handle.   |
| <a href="#">dx</a>   | Difference in X. |
| <a href="#">dy</a>   | Difference in Y. |



### 6.1.8.2.70 WM\_Screen2hWin()

#### Description

Returns the window which lies at the specified position.

#### Prototype

```
WM_HWIN WM_Screen2hWin(int x,  
                       int y);
```

#### Parameters

| Parameter      | Description  |
|----------------|--------------|
| <code>x</code> | X-coordinate |
| <code>y</code> | Y-coordinate |

#### Return value

Handle to the found window.

### 6.1.8.2.71 WM\_Screen2hWinEx()

#### Description

Returns the window which lies at the specified position.

#### Prototype

```
WM_HWIN WM_Screen2hWinEx(WM_HWIN hStop,  
                          int      x,  
                          int      y);
```

#### Parameters

| Parameter             | Description   |
|-----------------------|---|
| <a href="#">hStop</a> | Handle of a descendant (low-level window) to stop at. |
| <a href="#">x</a>     | X-coordinate  |
| <a href="#">y</a>     | Y-coordinate  |

#### Return value

Handle to the found window. If [hStop](#) was found the handle to its parent window is returned.

### 6.1.8.2.72 WM\_SelectWindow()

#### Description

Selects a window to be used for drawing operations. The selected window is also called the active window.

#### Prototype

```
WM_HWIN WM_SelectWindow(WM_HWIN hWin);
```

#### Parameters

| Parameter         | Description    |
|-------------------|----------------|
| <code>hWin</code> | Window handle. |

#### Return value

The previously selected window.

#### Additional information

If using this function it is possible to paint into a window from outside of the Window Manager, in general this is not recommended. Further you will not benefit from the automatic multi buffering and memory device feature of the Window Manager. Use this function very rarely and only as a last choice.

This function should not be called within a paint function called by the Window Manager. If the Window Manager sends a `WM_PAINT` message the target window already has been selected.

When working with a multi layer configuration the function switches also to the layer of the top level parent window of the given window.

If the given window handle is 0 the function selects the first created window, normally the first desktop window.

#### Example

Sets a window with handle `hWin2` to the active window, sets the background color, and then clears the window:

```
WM_SelectWindow(hWin2);
GUI_SetBkColor(0xFF00);
GUI_Clear();
```

### 6.1.8.2.73 WM\_SendMessage()

#### Description

Sends a message to a specified window.

#### Prototype

```
void WM_SendMessage(WM_HWIN      hWin,  
                   WM_MESSAGE * pMsg);
```

#### Parameters

| Parameter         | Description   |
|-------------------|---|
| <code>hWin</code> | Window handle.  |
| <code>pMsg</code> | Pointer to a <code>WM_MESSAGE</code> structure. See <i>Elements of structure WM_MESSAGE</i> . |

#### Additional information

This function can be also used to send custom messages as described in the section *Application-defined messages* on page 818.

### 6.1.8.2.74 WM\_SendMessageNoPara()

#### Description

Sends a message without parameters to a specified window.

#### Prototype

```
void WM_SendMessageNoPara(WM_HWIN hWin,  
                           int      MsgId);
```

#### Parameters

| Parameter          | Description               |
|--------------------|---------------------------|
| <code>hWin</code>  | Window handle.            |
| <code>MsgId</code> | Id of message to be sent. |

#### Additional information

If only a message Id should be sent to a window this should be done with this function, because it does not need a pointer to a `WM_MESSAGE` structure. Note that the receiving window gets no further information except the message Id.

This function can be used to send application-defined messages. Refer to the chapter *Application-defined messages* on page 818.

### 6.1.8.2.75 WM\_SendToParent()

#### Description

Sends the given message to the parent window of the given window.

#### Prototype

```
void WM_SendToParent(WM_HWIN      hChild,  
                    WM_MESSAGE * pMsg);
```

#### Parameters

| Parameter         | Description                      |
|-------------------|----------------------------------|
| <code>hWin</code> | Window handle.                   |
| <code>pMsg</code> | Pointer to WM_MESSAGE-structure. |

### 6.1.8.2.76 WM\_SetCallback()

#### Description

Sets a callback routine to be executed by the Window Manager.

#### Prototype

```
WM_CALLBACK *WM_SetCallback(WM_HWIN hWin,  
                             WM_CALLBACK * cb);
```

#### Parameters

| Parameter            | Description                  |
|----------------------|------------------------------|
| <a href="#">hWin</a> | Window handle.               |
| <a href="#">cb</a>   | Pointer to callback routine. |

#### Return value

Pointer to the previous callback routine.

#### Additional information

The given window will be invalidated. This makes sure the window will be redrawn.

### 6.1.8.2.77 WM\_SetCapture()

#### Description

Routes all PID-messages to the given window.

#### Prototype

```
void WM_SetCapture(WM_HWIN hObj,  
                  int      AutoRelease);
```

#### Parameters

| Parameter                | Description   |
|--------------------------|---|
| <code>hWin</code>        | Window handle.  |
| <code>AutoRelease</code> | 1 if capturing should end when the user releases the touch. |



### 6.1.8.2.78 WM\_SetCaptureMove()

#### Description

Moves a window according to the given PID state. This function is intended to be used in a window callback function. It should react to the message WM\_TOUCH if the PID is in pressed state.

#### Prototype

```
void WM_SetCaptureMove(    WM_HWIN        hWin,
                          const GUI_PID_STATE * pState,
                          int             MinVisibility,
                          int             LimitTop);
```

#### Parameters

| Parameter                  | Description  |
|----------------------------|--|
| <code>hWin</code>          | Handle of the window which should be moved.  |
| <code>pState</code>        | Pointer to the PID state.  |
| <code>MinVisibility</code> | Defines the minimum visibility of the parent window in pixels. The window will not be moved farther than the parent window reduced by the minimum visibility.                            |
| <code>LimitTop</code>      | Defines a number of top pixel lines which can not be moved outside the parent rectangle. The bottom pixel lines which are excluded are allowed to be moved outside the parent rectangle. |

#### Example

The following example application shows a callback function of a window which is moved using WM\_SetCaptureMove():

```
static void _cbWin(WM_MESSAGE * pMsg) {
    const GUI_PID_STATE * pState;
    WM_HWIN hWin;
    hWin = pMsg->hWin;
    switch (pMsg->MsgId) {
    case WM_TOUCH:
        pState = (const GUI_PID_STATE *)pMsg->Data.p;
        if (pState) {
            if (pState->Pressed) {
                WM_SetCaptureMove(hWin, pState, 0, 0);
            }
        }
        break;
    case WM_PAINT:
        GUI_SetBkColor(GUI_DARKBLUE);
        GUI_Clear();
        break;
    default:
        WM_DefaultProc(pMsg);
    }
}

void MainTask(void) {
    WM_HWIN hWin;

    GUI_Init();
    WM_SetDesktopColor(GUI_DARKGREEN);
    hWin = WM_CreateWindow(10, 10, 200, 100, WM_CF_SHOW, _cbWin, 0);
    while (1) { GUI_Delay(1); }
}
```

### 6.1.8.2.79 WM\_SetCreateFlags()

#### Description

Sets the flags to be used as default when creating a new window.

#### Prototype

```
U32 WM_SetCreateFlags(U32 Flags);
```

#### Parameters

| Parameter | Description   |
|-----------|---|
| Flags     | Window create flags (see <i>Window create flags</i> on page 977). |

#### Return value

Former value of this parameter.

#### Additional information

The flags specified here are binary ORed with the flags specified in the `WM_CreateWindow()` and `WM_CreateWindowAsChild()` routines.

The flag `WM_CF_MEMDEV` is frequently used to enable Memory Devices on all windows. Setting create flags is permitted before `GUI_Init()` is called. This causes the background window to be also affected by the create flags.

#### Example

```
WM_SetCreateFlags(WM_CF_MEMDEV); // Auto. use Memory Devices on all windows
```

### 6.1.8.2.80 WM\_SetDesktopColor()

#### Description

Sets the color for the desktop window.

#### Prototype

```
GUI_COLOR WM_SetDesktopColor(GUI_COLOR Color);
```

#### Parameters

| Parameter | Description                                 |
|-----------|---|
| Color     | Color for desktop window, 24-bit RGB value. |

#### Return value

The previously selected desktop window color.

#### Additional information

The default setting for the desktop window is not to repaint itself. If this function is not called, the desktop window will not be redrawn at all; therefore other windows will remain visible even after they are deleted.

Once a color is specified with this function, the desktop window will repaint itself. In order to restore the default, call this function and specify `GUI_INVALID_COLOR`.

### 6.1.8.2.81 WM\_SetDesktopColorEx()

#### Description

Sets the color for the desktop window in a multi layer environment.

#### Prototype

```
GUI_COLOR WM_SetDesktopColorEx(GUI_COLOR Color,  
                               unsigned int LayerIndex);
```

#### Parameters

| Parameter               | Description  |
|-------------------------|--|
| <code>Color</code>      | <code>Color</code> for desktop window, 24-bit RGB value. |
| <code>LayerIndex</code> | Index of the layer.                                      |

#### Return value

The previously selected desktop window color.

#### Additional information

See `WM_SetDesktopColor()`.

### 6.1.8.2.82 WM\_SetEnableState()

#### Description

Sets the window to an enabled or disabled state.

#### Prototype

```
void WM_SetEnableState(WM_HWIN hWin,  
                      int      State);
```

#### Parameters

| Parameter          | Description                              |
|--------------------|--|
| <code>hWin</code>  | Window handle.                           |
| <code>State</code> | 1 to enable window, 0 to disable window. |

### 6.1.8.2.83 WM\_SetFocus()

#### Description

Sets the input focus to a specified window.

#### Prototype

```
int WM_SetFocus(WM_HWIN hWin);
```

#### Parameters

| Parameter         | Description    |
|-------------------|----------------|
| <code>hWin</code> | Window handle. |

#### Return value

= 0      if window accepted focus.  
≠ 0      if it could not.

#### Additional information

The window receives a `WM_SET_FOCUS` message which gives it the input focus. If for some reason the window could not accept the focus, nothing happens.

### 6.1.8.2.84 WM\_SetHasTrans()

#### Description

Enables transparency for the given window.

#### Prototype

```
void WM_SetHasTrans(WM_HWIN hWin);
```

#### Parameters

| Parameter         | Description    |
|-------------------|----------------|
| <code>hWin</code> | Window handle. |

#### Additional information

Using this function causes the Window Manager to redraw the background of the given window in order to have the transparent parts updated before the actual window is drawn.

### 6.1.8.2.85 WM\_SetId()

#### Description

This function sends a WM\_SET\_ID message to the given window.

#### Prototype

```
void WM_SetId(WM_HWIN hObj,  
              int      Id);
```

#### Parameters

| Parameter            | Description                                  |
|----------------------|--|
| <a href="#">hObj</a> | Window handle.                               |
| <a href="#">Id</a>   | <a href="#">Id</a> to be sent to the window. |

#### Additional information

This function can be used to change the [Id](#) of a widget. It works with every widget. When using this function with an application defined window, the callback function of the window should handle the message. Otherwise it will be ignored.



### 6.1.8.2.86 WM\_SetModalLayer()

#### Description

emWin supports one modal window on each layer per default. But sometimes it could make sense to have only one modal window. To be able to achieve that function could be used. Once a modal layer has been set only windows of that layer will receive input.

#### Prototype

```
int WM_SetModalLayer(int LayerIndex);
```

#### Parameters

| Parameter                  | Description   |
|----------------------------|---|
| <a href="#">LayerIndex</a> | Layer to be set as modal layer, -1 means no modal layer |

#### Return value

- ≥ 0 Index of previous modal layer.
- = -1 No modal layer was used previously.
- = -2 Error.

### 6.1.8.2.87 WM\_SetpfPollPID()

#### Description

Sets a function which will be called by the Window Manager in order to poll the pointer input device (touch-screen or mouse).

#### Prototype

```
WM_tfPollPID *WM_SetpfPollPID(WM_tfPollPID * pf);
```

#### Parameters

| Parameter       | Description   |
|-----------------|---|
| <code>pf</code> | Pointer to a function of type <code>WM_tfPollPID</code> . |

#### Return value

$\geq 0$  Index of previous modal layer.  
= -1 No modal layer was used previously.  
= -2 Error.

#### Additional information

The function type is defined as follows:

```
typedef void WM_tfPollPID(void);
```

#### Example

Example of a touch-screen handled as a device:

```
void ReadTouch(void) {  
    // ...read touchscreen  
}  
WM_SetpfPollPID(ReadTouch);
```

### 6.1.8.2.88 WM\_SetSize()

#### Description

Sets the new size of a window.

#### Prototype

```
void WM_SetSize(WM_HWIN hWin,  
               int      xSize,  
               int      ySize);
```

#### Parameters

| Parameter             | Description    |
|-----------------------|----------------|
| <a href="#">hWin</a>  | Window handle. |
| <a href="#">xSize</a> | New size in X. |
| <a href="#">ySize</a> | New size in Y. |

### 6.1.8.2.89 WM\_SetUntouchable()

#### Description

This function makes a window 'untouchable'. It has the same effect than the create flag WM\_CF\_UNTOUCHABLE.

#### Prototype

```
int WM_SetUntouchable(WM_HWIN hWin,  
                      int      OnOff);
```

#### Parameters

| Parameter          | Description  |
|--------------------|--|
| <code>hWin</code>  | Window handle.   |
| <code>OnOff</code> | Enables (1) or disables (0) touch for a specific window. |

#### Return value

Old status.

0 Window was previously not untouchable.

1 Window was previously untouchable.

#### Additional information

Calling this function will cause a window to route touch input to its parent. This way it is possible to place window over another window, but the lower window will still receive touch input.

### 6.1.8.2.90 WM\_SetWindowPos()

#### Description

Sets the size and the position of a window.

#### Prototype

```
void WM_SetWindowPos(WM_HWIN hWin,  
                    int      xPos,  
                    int      yPos,  
                    int      xSize,  
                    int      ySize);
```

#### Parameters

| Parameter             | Description                               |
|-----------------------|---|
| <a href="#">hWin</a>  | Window handle.                            |
| <a href="#">xPos</a>  | New position in X in desktop coordinates. |
| <a href="#">yPos</a>  | New position in Y in desktop coordinates. |
| <a href="#">xSize</a> | New size in X.                            |
| <a href="#">ySize</a> | New size in Y.                            |

### 6.1.8.2.91 WM\_SetXSize()

#### Description

Sets the new X-size of a window.

#### Prototype

```
int WM_SetXSize(WM_HWIN hWin,  
               int      XSize);
```

#### Parameters

| Parameter          | Description    |
|--------------------|----------------|
| <code>hWin</code>  | Window handle. |
| <code>XSize</code> | New size in X. |

### 6.1.8.2.92 WM\_SetYSize()

#### Description

Sets the new Y-size of a window.

#### Prototype

```
int WM_SetYSize(WM_HWIN hWin,  
               int YSize);
```

#### Parameters

| Parameter          | Description    |
|--------------------|----------------|
| <code>hWin</code>  | Window handle. |
| <code>YSize</code> | New size in Y. |

### 6.1.8.2.93 WM\_SetStayOnTop()

#### Description

Sets the stay on top flag.

#### Prototype

```
void WM_SetStayOnTop(WM_HWIN hWin,  
                    int      OnOff);
```

#### Parameters

| Parameter          | Description      |
|--------------------|------------------|
| <code>hWin</code>  | Window handle.   |
| <code>OnOff</code> | See table below. |

| Permitted values for parameter <code>OnOff</code> |                                    |
|---|------------------------------------|
| 0   | Stay on top flag would be cleared. |
| 1   | Stay on top flag would be set.     |



### 6.1.8.2.94 WM\_SetTransState()

#### Description

This function sets or clears the flags `WM_CF_HASTRANS` and `WM_CF_CONST_OUTLINE` of the given window.

#### Prototype

```
void WM_SetTransState(WM_HWIN hWin,  
                     unsigned State);
```

#### Parameters

| Parameter          | Description   |
|--------------------|---|
| <code>hWin</code>  | Window handle.  |
| <code>State</code> | Combination of the flags <code>WM_CF_HASTRANS</code> and <code>WM_CF_CONST_OUTLINE</code> . |

#### Additional information

Details about the flags `WM_CF_CONST_OUTLINE` and `WM_CF_HASTRANS` can be found in the function description of `WM_CreateWindow()`.

### 6.1.8.2.95 WM\_SetUserClipRect()

#### Description

Temporarily reduces the clip area of the current window to a specified rectangle.

#### Prototype

```
GUI_RECT *WM_SetUserClipRect(const GUI_RECT * pRect);
```

#### Parameters

| Parameter          | Description   |
|--------------------|---|
| <code>pRect</code> | Pointer to a <code>GUI_RECT</code> structure defining the clipping region in desktop coordinates. |

#### Return value

Pointer to the previous clip rectangle.

#### Additional information

A `NULL` pointer can be passed in order to restore the default settings. The clip rectangle will automatically be reset by the WM when callbacks are used.

The specified rectangle must be relative to the current window. You cannot enlarge the clip rectangle beyond the current window rectangle.

Your application must ensure that the specified rectangle retains its value until it is no longer needed; that is, until a different clip rectangle is specified or until a `NULL` pointer is passed. This means that the rectangle structure passed as parameter should not be an auto variable (usually located on the stack) if the clip rectangle remains active until after the return. In this case, a static variable should be used.

#### Example

This example is taken from the drawing routine of a progress indicator. The progress indicator must write text on top of the progress bar, where the text color has to be different on the left and right parts of the bar. This means that half of a digit could be in one color, while the other half could be in a different color. The best way to do this is to temporarily reduce the clip area when drawing each part of the bar as shown below:

```
/* Draw left part of the bar */
r.x0=0; r.x1=x1-1; r.y0=0; r.y1 = GUI_YMAX;
WM_SetUserClipRect(&r);
GUI_SetBkColor(pThis->ColorBar[0]);
GUI_SetColor(pThis->ColorText[0]);
GUI_Clear();
GUI_GotoXY(xText,yText); GUI_DispDecMin(pThis->v); GUI_DispChar('%');
/* Draw right part of the bar */
r.x0=r.x1; r.x1=GUI_XMAX;
WM_SetUserClipRect(&r);
GUI_SetBkColor(pThis->ColorBar[1]);
GUI_SetColor(pThis->ColorText[1]);
GUI_Clear();
GUI_GotoXY(xText,yText); GUI_DispDecMin(pThis->v); GUI_DispChar('%');
```

#### Screenshot of progress bar

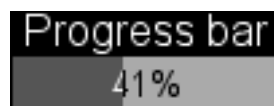

### 6.1.8.2.96 WM\_SetUserData()

#### Description

Sets the extra data of a window. Memory for extra data is reserved with the parameter NumExtraBytes when creating a window.

#### Prototype

```
int WM_SetUserData(      WM_HWIN  hWin,  
                        const void * pSrc,  
                        int        NumBytes);
```

#### Parameters

| Parameter             | Description        |
|-----------------------|--------------------|
| <code>hWin</code>     | Window handle.     |
| <code>pSrc</code>     | Pointer to buffer. |
| <code>NumBytes</code> | Size of buffer.    |

#### Return value

Number of bytes written.

#### Additional information

The maximum number of bytes used to store user data is the number of ExtraBytes specified when creating a window.

### 6.1.8.2.97 WM\_ShowWindow()

#### Description

Makes a specified window visible.

#### Prototype

```
void WM_ShowWindow(WM_HWIN hWin);
```

#### Parameters

| Parameter         | Description    |
|-------------------|----------------|
| <code>hWin</code> | Window handle. |

#### Return value

Number of bytes written.

#### Additional information

The window will not immediately be visible after calling this function. It will be redrawn when executing `WM_Exec()`. If you need to show (draw) the window immediately, you should call `WM_Paint()`.

### 6.1.8.2.98 WM\_Update()

#### Description

Draws the invalid part of the specified window immediately.

#### Prototype

```
void WM_Update(WM_HWIN hWin);
```

#### Parameters

| Parameter         | Description    |
|-------------------|----------------|
| <code>hWin</code> | Window handle. |

#### Additional information

After updating a window its complete region is marked as valid.

### 6.1.8.2.99 WM\_UpdateWindowAndDescs()

#### Description

Paints the invalid part of the given window and the invalid part of all its descendants.

#### Prototype

```
void WM_UpdateWindowAndDescs(WM_HWIN hWin);
```

#### Parameters

| Parameter         | Description    |
|-------------------|----------------|
| <code>hWin</code> | Window handle. |

#### Additional information

The function only draws the invalid window regions.

### 6.1.8.2.100 WM\_ValidateRect()

#### Description

Validates a specified, rectangular area of a window.

#### Prototype

```
void WM_ValidateRect(      WM_HWIN    hWin,  
                        const GUI_RECT * pRect);
```

#### Parameters

| Parameter          | Description  |
|--------------------|--|
| <code>hWin</code>  | Window handle.   |
| <code>pRect</code> | Pointer to a <code>GUI_RECT</code> structure with window coordinates of the parent window. |

#### Additional information

Calling this function will tell the WM that the specified area is updated. Normally this function is called internally and does not need to be called by the user application. The coordinates of the `GUI_RECT` structure have to be in desktop coordinates.

### 6.1.8.2.101 WM\_ValidateWindow()

#### Description

Validates a specified window.

#### Prototype

```
void WM_ValidateWindow(WM_HWIN hWin);
```

#### Parameters

| Parameter          | Description  |
|--------------------|--|
| <code>hWin</code>  | Window handle.   |
| <code>pRect</code> | Pointer to a <code>GUI_RECT</code> structure with window coordinates of the parent window. |

#### Additional information

Calling this function will tell the WM that the specified window is updated. Normally this function is called internally and does not need to be called by the user application.



### 6.1.8.2.102 WM\_XY2Screen()

#### Description

Converts the given coordinates (relative to the given window) into screen coordinates.

#### Prototype

```
void WM_XY2Screen(WM_HWIN  hWin,  
                 int       * px,  
                 int       * py);
```

#### Parameters

| Parameter            | Description                              |
|----------------------|--|
| <a href="#">hWin</a> | Window handle.                           |
| <a href="#">px</a>   | Pointer to a x position to be converted. |
| <a href="#">py</a>   | Pointer to a y position to be converted. |

#### Additional information

This function is very useful when using Memory Devices in combination with windows/widgets, because Memory Device use coordinates relative to the screen.

### 6.1.8.2.103 WM\_XY2Client()

#### Description

Converts the given coordinates (relative to the screen) into coordinates relative to the given window.

#### Prototype

```
void WM_XY2Client(WM_HWIN hWin,  
                 int * px,  
                 int * py);
```

#### Parameters

| Parameter            | Description                              |
|----------------------|--|
| <a href="#">hWin</a> | Window handle.                           |
| <a href="#">px</a>   | Pointer to a x position to be converted. |
| <a href="#">py</a>   | Pointer to a y position to be converted. |

### 6.1.8.3 Motion support

#### 6.1.8.3.1 WM\_MOTION\_Enable()

##### Description

Enables motion support for the WM. Needs to be called once at the beginning of the program.

##### Prototype

```
void WM_MOTION_Enable(int OnOff);
```

##### Parameters

| Parameter | Description  |
|-----------|--|
| OnOff     | 1 for enabling motion support, 0 for disabling it. |

### 6.1.8.3.2 WM\_MOTION\_SetDeceleration()

#### Description

Can be used to set the deceleration of the current moving operation.

#### Prototype

```
void WM_MOTION_SetDeceleration(WM_HWIN hWin,
                               int      Axis,
                               I32     Deceleration);
```

#### Parameters

| Parameter                    | Description                                     |
|------------------------------|---|
| <a href="#">hWin</a>         | Window handle.                                  |
| <a href="#">Axis</a>         | See table below.                                |
| <a href="#">Deceleration</a> | <a href="#">Deceleration</a> in pixel / (s * s) |

| Permitted values for parameter <a href="#">Axis</a> |                        |
|---|------------------------|
| GUI_COORD_X   | X axis should be used. |
| GUI_COORD_Y   | Y axis should be used. |

#### Additional information

Makes only sense if the given window is already moving.

### 6.1.8.3.3 WM\_MOTION\_SetDefaultPeriod()

#### Description

Sets the default value to be used for the duration of the deceleration phase after the PID has been released. If the window is already moving the window decelerates its motion until it stops. If the window is not moving but snapping is used the window moves within that period to the next raster position. If the window is already moving and snapping is used the window decelerates its motion until it stops to the nearest raster position given by the current speed.

#### Prototype

```
unsigned WM_MOTION_SetDefaultPeriod(unsigned Period);
```

#### Parameters

| Parameter           | Description                     |
|---------------------|---------------------------------|
| <code>Period</code> | <code>Period</code> to be used. |

#### Return value

Previous default value of the period.

### 6.1.8.3.4 WM\_MOTION\_SetMotion()

#### Description

Starts a moving operation with the given speed and deceleration.

#### Prototype

```
void WM_MOTION_SetMotion(WM_HWIN hWin,
                        int      Axis,
                        I32      Speed,
                        I32      Deceleration);
```

#### Parameters

| Parameter                    | Description                              |
|------------------------------|--|
| <a href="#">hWin</a>         | Window handle.                           |
| <a href="#">Axis</a>         | See table below.                         |
| <a href="#">Speed</a>        | <a href="#">Speed</a> to be used.        |
| <a href="#">Deceleration</a> | <a href="#">Deceleration</a> to be used. |

| Permitted values for parameter <a href="#">Axis</a> |                        |
|---|------------------------|
| GUI_COORD_X   | X axis should be used. |
| GUI_COORD_Y   | Y axis should be used. |

#### Additional information

The moving operation then can be affected by further motion functions.

### 6.1.8.3.5 WM\_MOTION\_SetMoveable()

#### Description

Enables movability of the given window.

#### Prototype

```
void WM_MOTION_SetMoveable(WM_HWIN hWin,
                           U32     Flags,
                           int     OnOff);
```

#### Parameters

| Parameter          | Description  |
|--------------------|--|
| <code>hWin</code>  | Window handle.   |
| <code>Flags</code> | Permitted values are listed under <i>Motion flags</i> on page 971. |
| <code>OnOff</code> | 1 for enabling, 0 for disabling.                                   |

| Permitted values for parameter <code>Flags</code> |  |
|---|--|
| <code>WM_CF_MOTION_R</code>                       | Enables circular movability for objects within the window. |
| <code>WM_CF_MOTION_X</code>                       | Enables / disables movability for the X axis.              |
| <code>WM_CF_MOTION_Y</code>                       | Enables / disables movability for the Y axis.              |

#### Additional information

Motion support of a window can also be set with creation flags when creating the window or within the callback routine of the window. Details can be found in the section *Motion support*.

### 6.1.8.3.6 WM\_MOTION\_SetMovement()

#### Description

Starts a moving operation with the given speed for the given distance.

#### Prototype

```
void WM_MOTION_SetMovement (WM_HWIN hWin,
                             int      Axis,
                             I32      Speed,
                             I32      Dist);
```

#### Parameters

| Parameter             | Description   |
|-----------------------|---|
| <a href="#">hWin</a>  | Window handle.  |
| <a href="#">Axis</a>  | See table below.  |
| <a href="#">Speed</a> | <a href="#">Speed</a> in pixels / s to be used. Positive and negative values are supported. |
| <a href="#">Dist</a>  | Distance to be used. Needs to be a positive value.  |

| Permitted values for parameter <a href="#">Axis</a> |                        |
|---|------------------------|
| GUI_COORD_X   | X axis should be used. |
| GUI_COORD_Y   | Y axis should be used. |

#### Additional information

The moving operation stops automatically if the given distance is reached.



### 6.1.8.3.7 WM\_MOTION\_SetSpeed()

#### Description

Starts moving the given window with the given speed.

#### Prototype

```
void WM_MOTION_SetSpeed(WM_HWIN hWin,
                        int      Axis,
                        I32      Speed);
```

#### Parameters

| Parameter             | Description                                     |
|-----------------------|---|
| <a href="#">hWin</a>  | Window handle.                                  |
| <a href="#">Axis</a>  | See table below.                                |
| <a href="#">Speed</a> | <a href="#">Speed</a> in pixels / s to be used. |

| Permitted values for parameter <a href="#">Axis</a> |                        |
|---|------------------------|
| GUI_COORD_X   | X axis should be used. |
| GUI_COORD_Y   | Y axis should be used. |

### 6.1.8.3.8 WM\_MOTION\_SetThreshold()

#### Description

Sets the number of pixels required for starting a move operation. When holding down a finger on a touchscreen the touch controller normally generates a lot of input containing different coordinates. The threshold value can be used to avoid moving in that case.

#### Prototype

```
void WM_MOTION_SetThreshold(unsigned Threshold);
```

#### Parameters

| Parameter             | Description                                     |
|-----------------------|---|
| <a href="#">hWin</a>  | Window handle.                                  |
| <a href="#">Axis</a>  | See table below.                                |
| <a href="#">Speed</a> | <a href="#">Speed</a> in pixels / s to be used. |

| Permitted values for parameter <a href="#">Axis</a> |                        |
|---|------------------------|
| GUI_COORD_X   | X axis should be used. |
| GUI_COORD_Y   | Y axis should be used. |

## 6.1.8.4 ToolTip related functions

In addition to the introduction at the beginning of the chapter the following contains the detailed descriptions of the ToolTip related functions.

### 6.1.8.4.1 WM\_TOOLTIP\_AddTool()

#### Description

Adds a tool to an existing ToolTip object.

#### Prototype

```
int WM_TOOLTIP_AddTool(      WM_TOOLTIP_HANDLE  hToolTip,
                             WM_HWIN             hTool,
                             const char           * pText);
```

#### Parameters

| Parameter             | Description               |
|-----------------------|---------------------------|
| <code>hToolTip</code> | Handle of ToolTip object. |
| <code>hTool</code>    | Handle of tool window.    |
| <code>pText</code>    | Pointer to a string.      |

#### Return value

= 0      on success  
 ≠ 0      on error.

#### Additional information

This function can be used for adding tools by passing the window Id and a string pointer. The given string is copied into the dynamic memory of emWin and does not need to remain valid.

### 6.1.8.4.2 WM\_TOOLTIP\_Create()

#### Description

Creates a ToolTip object for the given dialog.

#### Prototype

```
WM_TOOLTIP_HANDLE WM_TOOLTIP_Create(          WM_HWIN          hDlg,
                                           const TOOLTIP_INFO * pInfo,
                                           unsigned          NumItems);
```

#### Parameters

| Parameter             | Description   |
|-----------------------|---|
| <code>hDlg</code>     | Handle of the dialog containing the tools as child- or grand child windows.             |
| <code>pInfo</code>    | Pointer to an array of <code>TOOLTIP_INFO</code> structures. Can be <code>NULL</code> . |
| <code>NumItems</code> | Number of tools to be added.  |

#### Return value

Handle to the ToolTip object on success, 0 on failure.

#### Additional information

If one of the parameters `pInfo` or `NumItems` is 0 the function only creates the ToolTip object. It is the responsibility of the application to delete the object if it is no longer used.

### 6.1.8.4.3 WM\_TOOLTIP\_Delete()

#### Description

Deletes the given ToolTip object.

#### Prototype

```
void WM_TOOLTIP_Delete(WM_TOOLTIP_HANDLE hToolTip);
```

#### Parameters

| Parameter                | Description                             |
|--------------------------|---|
| <a href="#">hToolTip</a> | Handle of ToolTip object to be deleted. |

#### 6.1.8.4.4 WM\_TOOLTIP\_SetDefaultColor()

##### Description

Sets the default colors to be used for drawing ToolTips.

##### Prototype

```
GUI_COLOR WM_TOOLTIP_SetDefaultColor(unsigned Index,  
                                     GUI_COLOR Color);
```

##### Parameters

| Parameter             | Description   |
|-----------------------|---|
| <a href="#">Index</a> | See <i>ToolTip color indexes</i> on page 975 for a list of possible values. |
| <a href="#">Color</a> | Default color to be used.   |

##### Return value

Previous used color.

#### 6.1.8.4.5 WM\_TOOLTIP\_SetDefaultFont()

##### Description

Sets the font to be used for displaying the text of ToolTips.

##### Prototype

```
GUI_FONT *WM_TOOLTIP_SetDefaultFont(const GUI_FONT * pFont);
```

##### Parameters

| Parameter          | Description      |
|--------------------|------------------|
| <code>pFont</code> | Font to be used. |

##### Return value

Previous default font used for ToolTips.

#### 6.1.8.4.6 WM\_TOOLTIP\_SetDefaultPeriod()

##### Description

Sets the default periods to be used for showing ToolTips.

##### Prototype

```
unsigned WM_TOOLTIP_SetDefaultPeriod(unsigned Index,  
                                     unsigned Period);
```

##### Parameters

| Parameter              | Description  |
|------------------------|--|
| <a href="#">Index</a>  | See <i>ToolTip period indexes</i> on page 976 for a list of possible values. |
| <a href="#">Period</a> | <a href="#">Period</a> to be used.   |

##### Return value

Previously used value.



## 6.1.8.5 Multiple Buffering support

### 6.1.8.5.1 WM\_MULTIBUF\_Enable()

#### Description

This functions enables or disables the automatic use of Multiple Buffering by the Window Manager.

#### Prototype

```
int WM_MULTIBUF_Enable(int OnOff);
```

#### Parameters

| Parameter | Description  |
|-----------|--|
| OnOff     | 1 to enable the automatic use of multiple buffers. 0 to disable the automatic use of multiple buffers. |

#### Return value

Previous state.

#### Additional information

Detailed information on how to use Multiple Buffering can be found in the chapter *Multiple Buffering* on page 712.

## 6.1.8.6 Memory Device support (optional)

When a Memory Device is used for redrawing a window, all drawing operations are automatically routed to a Memory Device context and are executed in memory. Only after all drawing operations have been carried out is the window redrawn on the LCD, reflecting all updates at once. The advantage of using Memory Devices is that any flickering effects (which normally occur when the screen is continuously updated as drawing operations are executed) are eliminated.

For more information on how Memory Devices operate, see the chapter *Memory Devices* on page 2626.

### 6.1.8.6.1 WM\_DisableMemdev()

#### Description

Disables the use of Memory Devices for redrawing a window.

#### Prototype

```
void WM_DisableMemdev(WM_HWIN hWin);
```

#### Parameters

| Parameter         | Description    |
|-------------------|----------------|
| <code>hWin</code> | Window handle. |

### 6.1.8.6.2 WM\_EnableMemdev()

#### Description

Enables the use of Memory Devices for redrawing a window.

#### Prototype

```
void WM_EnableMemdev(WM_HWIN hWin);
```

#### Parameters

| Parameter         | Description    |
|-------------------|----------------|
| <code>hWin</code> | Window handle. |

## 6.1.8.7 Timer related

### 6.1.8.7.1 WM\_CreateTimer()

#### Description

Creates a timer which sends a message to the given window after the given time period has expired. The timer is associated to the given window.

#### Prototype

```
WM_HTIMER WM_CreateTimer(WM_HWIN hWin,
                          int      UserId,
                          int      Period,
                          int      Mode);
```

#### Parameters

| Parameter           | Description  |
|---------------------|--|
| <code>hWin</code>   | Handle of window to be informed.   |
| <code>UserId</code> | User defined Id. Can be set to 0 if not using multiple timers for the same window. |
| <code>Period</code> | Time period after which the given window should receive a message.                 |
| <code>Mode</code>   | (reserved for future use, should be 0)   |

#### Return value

Handle of the timer.

#### Additional information

The function creates a 'one shot timer' which sends a `WM_TIMER` message to the given window. After the timer period has expired the timer object remains valid and can be restarted using the function `WM_RestartTimer()` or deleted with `WM_DeleteTimer()`. Once a window is deleted the Window Manager automatically deletes all timers associated to the window.

#### Example

```
static void _cbWin(WM_MESSAGE * pMsg) {
    switch (pMsg->MsgId) {
        case WM_TIMER:
            /*
             * ... do something ...
             */
            WM_RestartTimer(pMsg->Data.v, 1000);
            break;
        default:
            WM_DefaultProc(pMsg);
    }
}
static void _DemoTimer(void) {
    WM_HWIN hWin;
    WM_HTIMER hTimer;
    hWin = WM_CreateWindow(10, 10, 100, 100, WM_CF_SHOW, _cbWin, 0);
    hTimer = WM_CreateTimer(hWin, 0, 1000, 0);
    while (1) {
        GUI_Exec();
    }
}
```

### 6.1.8.7.2 WM\_DeleteTimer()

#### Description

Deletes the given timer.

#### Prototype

```
void WM_DeleteTimer(WM_HTIMER hTimer);
```

#### Parameters

| Parameter           | Description                        |
|---------------------|------------------------------------|
| <code>hTimer</code> | Handle of the timer to be deleted. |

#### Additional information

After a timer has expired the timer object remains valid and will not be deleted automatically. If it is not used anymore it should be deleted using this function. Once a window is deleted the Window Manager automatically deletes all timers associated to the window.

### 6.1.8.7.3 WM\_GetTimerId()

#### Description

Gets the Id of the given timer.

#### Prototype

```
int WM_GetTimerId(WM_HTIMER hTimer);
```

#### Parameters

| Parameter           | Description          |
|---------------------|----------------------|
| <code>hTimer</code> | Handle of the timer. |

#### Return value

The Id of the timer which was previously set within the function `WM_CreateTimer()`.

#### 6.1.8.7.4 WM\_RestartTimer()

##### Description

Restarts the given timer with the given period.

##### Prototype

```
void WM_RestartTimer(WM_HTIMER hTimer,  
                    int Period);
```

##### Parameters

| Parameter           | Description                          |
|---------------------|--------------------------------------|
| <code>hTimer</code> | Handle of the timer to be restarted. |
| <code>Period</code> | New period to be used.               |

##### Additional information

If this function gets called with `Period` set to zero the timer gets restarted with the period set on creation. After the period has expired a `WM_TIMER` message will be sent to the window assigned to the timer. For details, refer to `WM_CreateTimer()`.

## 6.1.8.8 Widget related functions

### 6.1.8.8.1 WM\_GetClientWindow()

#### Description

Returns the handle of the client window. The function sends a message to the active window to retrieve the handle of the client window. If the window does not handle the message the handle of the current window will be returned.

#### Prototype

```
WM_HWIN WM_GetClientWindow(WM_HWIN hObj);
```

#### Parameters

| Parameter         | Description       |
|-------------------|-------------------|
| <code>hWin</code> | Handle of widget. |

#### Return value

Handle of the client window.

#### Additional information

Use this function to retrieve the client window handle of a FRAMEWIN widget.



### 6.1.8.8.2 WM\_GetContentRect()

#### Description

Returns the content rectangle of the current window. The rectangle is in client coordinates. The content rectangle of a window is the area that shows the actual content. For example for a LISTVIEW widget the content rectangle is the inside rectangle without its attached HEADER widget. For most widgets, it is the inside rectangle.

#### Prototype

```
void WM_GetContentRect(GUI_RECT * pRect);
```

#### Parameters

| Parameter          | Description                                       |
|--------------------|---|
| <code>pRect</code> | <code>out</code> Pointer to a GUI_RECT structure. |

### 6.1.8.8.3 WM\_GetContentRectEx()

#### Description

Returns the content rectangle of a given window. The rectangle is in client coordinates.

The content rectangle of a window is the area that shows the actual content. For example for a LISTVIEW widget the content rectangle is the inside rectangle without its attached HEADER widget. For most widgets, it is the inside rectangle.

#### Prototype

```
void WM_GetContentRectEx(WM_HWIN hWin,  
                        GUI_RECT * pRect);
```

#### Parameters

| Parameter          | Description                                 |
|--------------------|---|
| <code>hWin</code>  | Window handle.                              |
| <code>pRect</code> | <b>out</b> Pointer to a GUI_RECT structure. |

#### 6.1.8.8.4 WM\_GetId()

##### Description

Returns the ID of a specified widget window.

##### Prototype

```
int WM_GetId(WM_HWIN hObj);
```

##### Parameters

| Parameter         | Description       |
|-------------------|-------------------|
| <code>hObj</code> | Handle of widget. |

##### Return value

> 0 ID of the widget which was specified at creation or set using `WM_SetId()`.  
= 0 will be returned if the specified window is not a widget.

### 6.1.8.8.5 WM\_GetInsideRect()

#### Description

Returns the coordinates of the client area of the active widget less the border size. The function sends a message to the active window to retrieve the inside rectangle. If the widget does not handle the message (that means the widget has no border) `WM_GetClientRect` will be used to calculate the rectangle. The result is given in window coordinates. That means `x0` and `y0` of the `GUI_RECT` structure corresponds to the border size in `x` and `y`, `x1` and `y1` corresponds to the size of the window less the border size - 1.

This function sends the `WM_GET_INSIDE_RECT` message to the given window which should be filled by the user. This message is quite helpful when creating an own widget.

#### Prototype

```
void WM_GetInsideRect(GUI_RECT * pRect);
```

#### Parameters

| Parameter          | Description                                   |
|--------------------|---|
| <code>pRect</code> | Pointer to a <code>GUI_RECT</code> structure. |

### 6.1.8.8.6 WM\_GetInsideRectEx()

#### Description

Returns the coordinates of a window less the border size.

#### Prototype

```
void WM_GetInsideRectEx(WM_HWIN    hWin,  
                       GUI_RECT * pRect);
```

#### Parameters

| Parameter             | Description                      |
|-----------------------|----------------------------------|
| <a href="#">hObj</a>  | Handle of widget.                |
| <a href="#">pRect</a> | Pointer to a GUI_RECT structure. |

#### Additional information

For details, refer to `WM_GetInsideRect()`.

### 6.1.8.8.7 WM\_GetScrollbarH()

#### Description

If the given window has a horizontal scroll bar attached the function returns the handle of that scrollbar.

#### Prototype

```
WM_HWIN WM_GetScrollbarH(WM_HWIN hWin);
```

#### Parameters

| Parameter         | Description   |
|-------------------|---|
| <code>hWin</code> | Handle of a window which has a horizontal SCROLLBAR attached. |

#### Return value

Handle of the horizontal SCROLLBAR widget  
0, if no horizontal SCROLLBAR widget is attached.

#### Additional information

Additional information can be found in *SCROLLBAR: Scroll bar widget* on page .

### 6.1.8.8.8 WM\_GetScrollbarV()

#### Description

If the given window has a vertical scroll bar attached the function returns the handle of that scrollbar.

#### Prototype

```
WM_HWIN WM_GetScrollbarV(WM_HWIN hWin);
```

#### Parameters

| Parameter         | Description   |
|-------------------|---|
| <code>hWin</code> | Handle of a window which has a vertical SCROLLBAR attached. |

#### Return value

Handle of the vertical SCROLLBAR widget  
0, if no vertical SCROLLBAR widget is attached.

#### Additional information

Additional information can be found in *SCROLLBAR: Scroll bar widget* on page .

### 6.1.8.8.9 WM\_GetScrollPosH()

#### Description

Returns the horizontal scrolling position of a window.

#### Prototype

```
int WM_GetScrollPosH(WM_HWIN hWin);
```

#### Parameters

| Parameter         | Description   |
|-------------------|---|
| <code>hWin</code> | Handle of a window which has a horizontal SCROLLBAR attached. |

#### Return value

Position of the horizontal SCROLLBAR widget ( $0 < n$ )  
0, if no horizontal SCROLLBAR widget is attached.

#### Additional information

Additional information can be found in *SCROLLBAR: Scroll bar widget* on page .



### 6.1.8.8.10 WM\_GetScrollPosV()

#### Description

Returns the vertical scrolling position of a window.

#### Prototype

```
int WM_GetScrollPosV(WM_HWIN hWin);
```

#### Parameters

| Parameter         | Description   |
|-------------------|---|
| <code>hWin</code> | Handle of a window which has a horizontal SCROLLBAR attached. |

#### Return value

Position of the horizontal SCROLLBAR widget ( $0 < n$ )  
0, if no horizontal SCROLLBAR widget is attached.

#### Additional information

Additional information can be found in *SCROLLBAR: Scroll bar widget* on page .

### 6.1.8.8.11 WM\_GetScrollState()

#### Description

Fills a data structure with information of the current state of a specified SCROLLBAR widget.

#### Prototype

```
void WM_GetScrollState(WM_HWIN      hObj,  
                      WM_SCROLL_STATE * pScrollState);
```

#### Parameters

| Parameter                 | Description  |
|---------------------------|--|
| <code>hObj</code>         | Handle of scroll bar widget.                                       |
| <code>pScrollState</code> | Pointer to a data structure of type <code>WM_SCROLL_STATE</code> . |

#### Additional information

This function does not return since the state of a scroll bar is defined by more than one value.

It has no effect on other types of widgets or windows. Additional information can be found in *SCROLLBAR: Scroll bar widget* on page .

### 6.1.8.8.12 WM\_SetScrollPosH()

#### Description

Sets the horizontal scrolling position of a window.

#### Prototype

```
void WM_SetScrollPosH(WM_HWIN hWin,  
                     unsigned ScrollPos);
```

#### Parameters

| Parameter              | Description   |
|------------------------|---|
| <code>hWin</code>      | Handle of a window which has a horizontal SCROLLBAR attached. |
| <code>ScrollPos</code> | New scroll position of the scroll bar.                        |

#### Additional information

Additional information can be found in *SCROLLBAR: Scroll bar widget* on page .

### 6.1.8.8.13 WM\_SetScrollPosV()

#### Description

Sets the vertical scrolling position of a window.

#### Prototype

```
void WM_SetScrollPosV(WM_HWIN hWin,  
                     unsigned ScrollPos);
```

#### Parameters

| Parameter              | Description   |
|------------------------|---|
| <code>hWin</code>      | Handle of a window which has a vertical SCROLLBAR attached. |
| <code>ScrollPos</code> | New scroll position of the scroll bar.                      |

#### Additional information

Additional information can be found in *SCROLLBAR: Scroll bar widget* on page .

#### 6.1.8.8.14 WM\_SetScrollState()

##### Description

Sets the state of a specified SCROLLBAR widget.

##### Prototype

```
void WM_SetScrollState(      WM_HWIN      hWin,  
                          const WM_SCROLL_STATE * pState);
```

##### Parameters

| Parameter            | Description                  |
|----------------------|------------------------------|
| <a href="#">hObj</a> | Handle of scroll bar widget. |

## 6.1.8.9 Data structures

### 6.1.8.9.1 TOOLTIP\_INFO

#### Description

Contains the information about a ToolTip.

#### Type definition

```
typedef struct {  
    int      Id;  
    const char * pText;  
} TOOLTIP_INFO;
```

#### Structure members

| Member                | Description                                |
|-----------------------|--|
| <a href="#">Id</a>    | <a href="#">Id</a> of the ToolTip.         |
| <a href="#">pText</a> | String containing the text of the ToolTip. |

### 6.1.8.9.2 WM\_KEY\_INFO

#### Description

Contains information about a pressed key.

#### Type definition

```
typedef struct {  
    int Key;  
    int PressedCnt;  
} WM_KEY_INFO;
```

#### Structure members

| Member                     | Description  |
|----------------------------|--|
| <a href="#">Key</a>        | The key which has been pressed.                              |
| <a href="#">PressedCnt</a> |  |
| > 0                        | if the key has been pressed, 0 if the key has been released. |

### 6.1.8.9.3 WM\_MESSAGE

#### Description

Contains the data for a message sent by a window.

#### Type definition

```
typedef struct {
    int          MsgId;
    WM_HWIN     hWin;
    WM_HWIN     hWinSrc;
    union {
        const void * p;
        int          v;
        GUI_COLOR   Color;
        void         (* pFunc)(void);
    } Data;
} WM_MESSAGE;
```

#### Structure members

| Member               | Description                        |
|----------------------|------------------------------------|
| <code>MsgId</code>   | Type of message.                   |
| <code>hWin</code>    | Destination window.                |
| <code>hWinSrc</code> | Source window.                     |
| <code>Data</code>    | Data union. See elements below.    |
| Elements of Data     |                                    |
| <code>p</code>       | Message-specific data pointer.     |
| <code>v</code>       | Message-specific data value.       |
| <code>Color</code>   | Message-specific color.            |
| <code>pFunc</code>   | Message-specific function pointer. |



### 6.1.8.9.4 WM\_MOTION\_INFO

#### Description

Contains information about a move with motion support.

#### Type definition

```
typedef struct {
    U8          Cmd;
    U8          FinalMove;
    U8          StopMotion;
    U8          IsDragging;
    int         dx;
    int         dy;
    int         da;
    int         xPos;
    int         yPos;
    int         Period;
    int         SnapX;
    int         SnapY;
    U8          IsOutside;
    unsigned    Overlap;
    U32         Flags;
    GUI_PID_STATE * pState;
    GUI_HMEM    hContext;
    int         Dest;
} WM_MOTION_INFO;
```

#### Structure members

| Member                     | Description   |
|----------------------------|---|
| <a href="#">Cmd</a>        | Command. See <i>Motion messages</i> on page 972.                        |
| <a href="#">FinalMove</a>  | Set to 1 on the final moving operation.                                 |
| <a href="#">StopMotion</a> | Can be set to 1 to stop motion immediately.                             |
| <a href="#">IsDragging</a> | Is set to 1 if the PID is pressed, 0 if released.                       |
| <a href="#">dx</a>         | Distance in X to be used to move the window.                            |
| <a href="#">dy</a>         | Distance in Y to be used to move the window.                            |
| <a href="#">da</a>         | Distance in 1/10 degrees to be used to move an item.                    |
| <a href="#">xPos</a>       | Used to return the current position in X for custom moving operations.  |
| <a href="#">yPos</a>       | Used to return the current position in Y for custom moving operations.  |
| <a href="#">Period</a>     | Duration of the moving operation after the PID has been released.       |
| <a href="#">SnapX</a>      | Raster size in X for snapping operations, 0 if no snapping is required. |
| <a href="#">SnapY</a>      | Raster size in Y for snapping operations, 0 if no snapping is required. |
| <a href="#">IsOutside</a>  | If motion is managed by window.   |
| <a href="#">Overlap</a>    | Overlapping distance allowed for dragging operations.                   |
| <a href="#">Flags</a>      | To be used to enable motion support.                                    |
| <a href="#">pState</a>     | Internal use.   |
| <a href="#">hContext</a>   | Internal use.   |
| <a href="#">Dest</a>       | Internal use.   |

### 6.1.8.9.5 WM\_MOVE\_INFO

#### Description

Stores the distance of a window move operation.

#### Type definition

```
typedef struct {  
    int dx;  
    int dy;  
} WM_MOVE_INFO;
```

#### Structure members

| Member             | Description  |
|--------------------|--|
| <a href="#">dx</a> | Difference between old and new position on the X-axis. |
| <a href="#">dy</a> | Difference between old and new position on the Y-axis. |

### 6.1.8.9.6 WM\_PID\_STATE\_CHANGED\_INFO

#### Description

Information about the changed PID state. Sent to a window with the WM\_PID\_STATE\_CHANGED message.

#### Type definition

```
typedef struct {  
    int x;  
    int y;  
    U8 State;  
    U8 StatePrev;  
} WM_PID_STATE_CHANGED_INFO;
```

#### Structure members

| Member                 | Description   |
|------------------------|---|
| <code>x</code>         | Horizontal position of the PID in window coordinates. |
| <code>y</code>         | Vertical position of the PID in window coordinates.   |
| <code>State</code>     | Pressed state (> 0 if PID is pressed).                |
| <code>StatePrev</code> | Previous pressed state.                               |

### 6.1.8.9.7 WM\_SCROLL\_STATE

#### Description

Saves the scrollstate of a scrollbar.

#### Type definition

```
typedef struct {  
    int NumItems;  
    int v;  
    int PageSize;  
} WM_SCROLL_STATE;
```

#### Structure members

| Member                   | Description                          |
|--------------------------|--------------------------------------|
| <a href="#">NumItems</a> | Number of items.                     |
| <a href="#">v</a>        | Current value.                       |
| <a href="#">PageSize</a> | Number of items visible on one page. |

## 6.1.8.10 Defines

### 6.1.8.10.1 Message IDs

#### Description

List of all messages sent by the Window Manager. The member `MsgId` of the `WM_MESSAGE` structure contains one of these values to identify a message.

#### Definition

```
#define WM_CREATE           0x0001
#define WM_MOVE            0x0003
#define WM_SIZE            0x0005
#define WM_DELETE         11
#define WM_TOUCH          0x0240
#define WM_TOUCH_CHILD    13
#define WM_KEY            14
#define WM_PAINT          0x000F
#define WM_MOUSEOVER      16
#define WM_MOUSEOVER_END  18
#define WM_PID_STATE_CHANGED 17
#define WM_GET_INSIDE_RECT 20
#define WM_GET_ID         21
#define WM_SET_ID         22
#define WM_INIT_DIALOG    29
#define WM_SET_FOCUS      30
#define WM_GET_ACCEPT_FOCUS 31
#define WM_NOTIFY_PARENT  38
#define WM_NOTIFY_VIS_CHANGED 41
#define WM_PRE_PAINT      46
#define WM_POST_PAINT     47
#define WM_MOTION         48
#define WM_USER_DATA      52
#define WM_SET_CALLBACK    53
#define WM_TIMER          0x0113
#define WM_USER           0x0400
```

#### Symbols

| Definition                     | Description  |
|--------------------------------|--|
| <a href="#">WM_CREATE</a>      | Sent immediately after a window has been created, giving the window the chance to initialize and create any child windows. |
| <a href="#">WM_MOVE</a>        | Sent to a window immediately after it has been moved.  |
| <a href="#">WM_SIZE</a>        | Sent to a window after its size has changed.   |
| <a href="#">WM_DELETE</a>      | Sent just before a window is deleted, telling the window to free its data structures (if any).                             |
| <a href="#">WM_TOUCH</a>       | Sent to a window once a pointer input device is pressed, pressed and moved or released over its area.                      |
| <a href="#">WM_TOUCH_CHILD</a> | Sent to a parent window if a child window has been touched by the pointer input device.                                    |
| <a href="#">WM_KEY</a>         | Sent to the window currently containing the focus if a key has been pressed.   |
| <a href="#">WM_PAINT</a>       | Sent to a window after it has become invalid and it should be redrawn.   |
| <a href="#">WM_MOUSEOVER</a>   | Sent to a window if a pointer input device touches the outline of a window. Only sent if mouse support is enabled.         |

| Definition                         | Description   |
|------------------------------------|---|
| <code>WM_MOUSEOVER_END</code>      | Sent to a window if a pointer input device has been moved out of the outline of a window. Only sent if mouse support is enabled.  |
| <code>WM_PID_STATE_CHANGED</code>  | Sent to the window pointed by the pointer input device when the pressed state has been changed.   |
| <code>WM_GET_INSIDE_RECT</code>    | Sent to a window to get the client rectangle without the effect size.   |
| <code>WM_GET_ID</code>             | Sent to a window to request the Id of the window.   |
| <code>WM_SET_ID</code>             | Sent to a window to change the window Id.   |
| <code>WM_INIT_DIALOG</code>        | Sent to a dialog window immediately after the creation of the dialog.   |
| <code>WM_SET_FOCUS</code>          | Sent to a window if it gains or loses the input focus.  |
| <code>WM_GET_ACCEPT_FOCUS</code>   | Sent to a window to determine if the window is able to receive the input focus.   |
| <code>WM_NOTIFY_PARENT</code>      | Informs a parent window that something has occurred in one of its child windows. The information is detailed as a notification code.                                    |
| <code>WM_NOTIFY_VIS_CHANGED</code> | Sent to a window if its visibility has been changed.  |
| <code>WM_PRE_PAINT</code>          | Sent to a window before the first <code>WM_PAINT</code> message is sent.  |
| <code>WM_POST_PAINT</code>         | Sent to a window after the last <code>WM_PAINT</code> message was processed.  |
| <code>WM_MOTION</code>             | Sent to a window to achieve advanced motion support.  |
| <code>WM_USER_DATA</code>          | Sent to a window after user data has been set.  |
| <code>WM_SET_CALLBACK</code>       | Sent to a window after a callback has been set.   |
| <code>WM_TIMER</code>              | Sent to a window after a timer has expired.   |
| <code>WM_USER</code>               | The <code>WM_USER</code> constant can be used by applications to define private messages, usually of the form <code>(WM_USER + X)</code> , where X is an integer value. |

### Additional information

`WM_MOTION`, `WM_MOUSEOVER`, `WM_MOUSEOVER_END`, `WM_PID_STATE_CHANGED`, `WM_TOUCH` and `WM_TOUCH_CHILD` are "Pointer input device (PID) messages".

### 6.1.8.10.2 Motion flags

#### Description

Flags for motion support. The flags are supposed to be OR-combined with the member `Flags` of the `WM_MOTION_INFO` structure.

#### Definition

```
#define WM_MOTION_MANAGE_BY_WINDOW    (1 << 0)
```

#### Symbols

| Definition                              | Description                                  |
|---|--|
| <code>WM_MOTION_MANAGE_BY_WINDOW</code> | Window movement is managed by window itself. |

### 6.1.8.10.3 Motion messages

#### Description

Commands sent with a `WM_MOTION` message. The command can be found in the member `Cmd` of the `WM_MOTION_INFO` structure.

#### Definition

```
#define WM_MOTION_INIT          0
#define WM_MOTION_MOVE         1
#define WM_MOTION_GETPOS       2
#define WM_MOTION_GETCONTEXT   3
#define WM_MOTION_GETDEST      4
#define WM_MOTION_GETSNAP      5
```

#### Symbols

| Definition                        | Description   |
|-----------------------------------|---|
| <code>WM_MOTION_INIT</code>       | Sent to a window to initiate a motion operation.              |
| <code>WM_MOTION_MOVE</code>       | Sent to a window to achieve custom moving operations.         |
| <code>WM_MOTION_GETPOS</code>     | Sent to get the current position of custom moving operations. |
| <code>WM_MOTION_GETCONTEXT</code> | Internal use.   |
| <code>WM_MOTION_GETDEST</code>    | Sent to receive the desired position to move to               |
| <code>WM_MOTION_GETSNAP</code>    | Sent to receive the nearest snap position                     |

#### Additional information

More information about these commands can be read under *WM\_MOTION message and WM\_MOTION\_INFO* on page 807.



### 6.1.8.10.4 Motion overlap flags

#### Description

Flags for setting overlap behavior of widgets. The overlap will come into effect if a distance has been set.

#### Definition

```
#define WM_MOTION_OVERLAP_TOP      (1 << 0)
#define WM_MOTION_OVERLAP_BOTTOM  (1 << 1)
#define WM_MOTION_OVERLAP_LEFT    (1 << 2)
#define WM_MOTION_OVERLAP_RIGHT   (1 << 3)
```

#### Symbols

| Definition                               | Description  |
|--|--|
| <a href="#">WM_MOTION_OVERLAP_TOP</a>    | Overlap will be active at the top edge of the widget.    |
| <a href="#">WM_MOTION_OVERLAP_BOTTOM</a> | Overlap will be active at the bottom edge of the widget. |
| <a href="#">WM_MOTION_OVERLAP_LEFT</a>   | Overlap will be active at the left edge of the widget.   |
| <a href="#">WM_MOTION_OVERLAP_RIGHT</a>  | Overlap will be active at the right edge of the widget.  |

### 6.1.8.10.5 Notification codes

#### Description

List of all notifications sent by the Window Manager. A notification code is sent with a WM\_NOTIFY\_PARENT message and can be read with `pMsg->Data.v`.

#### Definition

```
#define WM_NOTIFICATION_CLICKED          1
#define WM_NOTIFICATION_RELEASED        2
#define WM_NOTIFICATION_MOVED_OUT        3
#define WM_NOTIFICATION_SEL_CHANGED      4
#define WM_NOTIFICATION_VALUE_CHANGED    5
#define WM_NOTIFICATION_SCROLLBAR_ADDED  6
#define WM_NOTIFICATION_CHILD_DELETED    7
#define WM_NOTIFICATION_GOT_FOCUS        8
#define WM_NOTIFICATION_LOST_FOCUS       9
#define WM_NOTIFICATION_SCROLL_CHANGED   10
#define WM_NOTIFICATION_SCROLLER_ADDED   16
```

#### Symbols

| Definition                      | Description  |
|---------------------------------|--|
| WM_NOTIFICATION_CLICKED         | This notification message will be sent when the window has been clicked.                                     |
| WM_NOTIFICATION_RELEASED        | This notification message will be sent when a clicked widget has been released.                              |
| WM_NOTIFICATION_MOVED_OUT       | This notification message will be sent when the pointer was moved out of the window while it is clicked.     |
| WM_NOTIFICATION_SEL_CHANGED     | This notification message will be sent when the selection of a widget has changed.                           |
| WM_NOTIFICATION_VALUE_CHANGED   | This notification message will be sent when a widget specific value has changed.                             |
| WM_NOTIFICATION_SCROLLBAR_ADDED | This notification message will be sent when a SCROLLBAR widget has been added to the window.                 |
| WM_NOTIFICATION_CHILD_DELETED   | This notification message will be sent from a window to its parent before it is deleted.                     |
| WM_NOTIFICATION_GOT_FOCUS       | This notification message will be sent once a window receives and accepts the focus.                         |
| WM_NOTIFICATION_LOST_FOCUS      | This notification message will be sent when the window has lost the focus.                                   |
| WM_NOTIFICATION_SCROLL_CHANGED  | This notification message will be sent when the scroll position of an attached SCROLLBAR widget has changed. |
| WM_NOTIFICATION_SCROLLER_ADDED  | This notification message will be sent when a SCROLLER widget has been added to the window.                  |

### 6.1.8.10.6 ToolTip color indexes

#### Description

Color indexes for ToolTip related routines.

#### Definition

```
#define WM_TOOLTIP_CI_BK      0
#define WM_TOOLTIP_CI_FRAME  1
#define WM_TOOLTIP_CI_TEXT   2
```

#### Symbols

| Definition                          | Description                          |
|-------------------------------------|--------------------------------------|
| <a href="#">WM_TOOLTIP_CI_BK</a>    | Color to be used for the background. |
| <a href="#">WM_TOOLTIP_CI_FRAME</a> | Color to be used for the thin frame. |
| <a href="#">WM_TOOLTIP_CI_TEXT</a>  | Color to be used for the text.       |

### 6.1.8.10.7 ToolTip period indexes

#### Description

Period indexes for ToolTip related routines.

#### Definition

```
#define WM_TOOLTIP_PI_FIRST    0
#define WM_TOOLTIP_PI_SHOW    1
#define WM_TOOLTIP_PI_NEXT    2
```

#### Symbols

| Definition                          | Description  |
|-------------------------------------|--|
| <a href="#">WM_TOOLTIP_PI_FIRST</a> | Period to be used the first time the PID is hovered over a tool. The ToolTip appears after the PID has not moved for at least this period. Default is 1000 ms.           |
| <a href="#">WM_TOOLTIP_PI_SHOW</a>  | Period to be used for showing the ToolTip. The ToolTip disappears after the PID remains for at least this period without moving. Default is 5000 ms.                     |
| <a href="#">WM_TOOLTIP_PI_NEXT</a>  | Period to be used if the PID hovers over a tool of the same parent as before. The ToolTip appears after the PID is not moved for at least this period. Default is 50 ms. |

### 6.1.8.10.8 Window create flags

#### Description

Flags that define a window upon creation. These flags can be passed to the create window function as flag-parameter. The flags are combinable using the binary OR-operator.

#### Definition

```
#define WM_CF_HASTRANS          (1UL << 0)
#define WM_CF_HIDE             (0UL << 1)
#define WM_CF_SHOW             (1UL << 1)
#define WM_CF_MEMDEV           (1UL << 2)
#define WM_CF_STAYONTOP        (1UL << 3)
#define WM_CF_DISABLED         (1UL << 4)
#define WM_CF_ACTIVATE         (1UL << 5)
#define WM_CF_FGND              (0UL << 6)
#define WM_CF_BGND              (1UL << 6)
#define WM_CF_ANCHOR_RIGHT     (1UL << 7)
#define WM_CF_ANCHOR_BOTTOM    (1UL << 8)
#define WM_CF_ANCHOR_LEFT      (1UL << 9)
#define WM_CF_ANCHOR_TOP       (1UL << 10)
#define WM_CF_CONST_OUTLINE    (1UL << 11)
#define WM_CF_LATE_CLIP         (1UL << 12)
#define WM_CF_MEMDEV_ON_REDRAW (1UL << 13)
#define WM_SF_INVALID_DRAW     (1UL << 14)
#define WM_SF_DELETE           (1UL << 15)
#define WM_CF_STATIC            (1UL << 16)
#define WM_CF_MOTION_X         (1UL << 17)
#define WM_CF_MOTION_Y         (1UL << 18)
#define WM_CF_GESTURE           (1UL << 19)
#define WM_CF_ZOOM              (1UL << 20)
#define WM_CF_MOTION_R         (1UL << 21)
#define WM_CF_UNTOUCHABLE      (1UL << 22)
#define WM_CF_APPWIZARD        (1UL << 23)
#define WM_CF_MEMDEV_CLIPPING  (1UL << 24)
```

#### Symbols

| Definition                      | Description  |
|---------------------------------|--|
| <a href="#">WM_CF_HASTRANS</a>  | Has transparency flag. Must be defined for windows whose client area is not entirely filled. To set this flag after the window has been created the function <code>WM_SetTransState()</code> should be used.   |
| <a href="#">WM_CF_HIDE</a>      | Hide window after creation (default).  |
| <a href="#">WM_CF_SHOW</a>      | Show window after creation.  |
| <a href="#">WM_CF_MEMDEV</a>    | Automatically use a Memory Device for drawing. This will avoid flickering and also improve the output speed in most cases, as clipping is simplified. The Window Manager creates a Memory Device for the current window according to the configured color depth and window size. The Memory Device is deleted immediately after the drawing process was finished.<br>In order to draw images into a remaining Memory Device the <code>IMAGE</code> widget can be used with the creation flag <code>IMAGE_CF_MEMDEV</code> . Details can be found in the section <i>IMAGE: Image widget</i> on page 1466. Note that the Memory Device package is required (and needs to be enabled in the configuration) in order to be able to use this flag. If Memory Devices are not enabled, this flag is ignored. |
| <a href="#">WM_CF_STAYONTOP</a> | Make sure window stays on top of all siblings created without this flag.   |

| Definition                          | Description   |
|-------------------------------------|---|
| <code>WM_CF_DISABLED</code>         | Window is disabled after creation. This means it receives no PID (mouse and touch) input.   |
| <code>WM_CF_ACTIVATE</code>         | Internal use.   |
| <code>WM_CF_FGND</code>             | Put window in foreground after creation (default).  |
| <code>WM_CF_BGND</code>             | Put window in background after creation.  |
| <code>WM_CF_ANCHOR_RIGHT</code>     | Anchors the right edge of the new window relative to the right edge of the parent window. If the position of the parent windows right edge will be adjusted due to a size change, the position of new window will also be adjusted.   |
| <code>WM_CF_ANCHOR_BOTTOM</code>    | Anchors the bottom edge of the new window relative to the bottom edge of the parent window. If the position of the parent windows bottom edge will be adjusted due to a size change, the position of new window will also be adjusted.  |
| <code>WM_CF_ANCHOR_LEFT</code>      | Anchors the left edge of the new window relative to the left edge of the parent window (default). If the position of the parent windows left edge will be adjusted due to a size change, the position of new window will also be adjusted.  |
| <code>WM_CF_ANCHOR_TOP</code>       | Anchors the top edge of the new window relative to the top edge of the parent window (default). If the position of the parent windows top edge will be adjusted due to a size change, the position of new window will also be adjusted.   |
| <code>WM_CF_CONST_OUTLINE</code>    | This flag is an optimization for transparent windows. It gives the Window Manager a chance to optimize redrawing and invalidation of transparent windows. A transparent window is normally redrawn as part of the background, which is less efficient than redrawing the window separately. However, this flag may NOT be used if the window has semi transparency (alpha blending / anti-aliasing with background) or the outline (the shape) changes with the window's states. To set this flag after the window has been created the function <code>WM_SetTransState()</code> should be used.  |
| <code>WM_CF_LATE_CLIP</code>        | This flag can be used to tell the WM that the clipping should be done in the drawing routines (late clipping). The default behavior of the WM is early clipping. That means that the clipping rectangle will be calculated before a <code>WM_PAINT</code> message will be sent to a window. In dependence of other existing windows it might be necessary to send more than one <code>WM_PAINT</code> message to a window. If using <code>WM_CF_LATE_CLIP</code> the WM makes sure only one message will be sent to an invalid window and the clipping will be done by the drawing routines. The <code>Sample</code> folder of <code>emWin</code> contains the example <code>WM_LateClipping.c</code> to show the effect. |
| <code>WM_CF_MEMDEV_ON_REDRAW</code> | Equals <code>WM_CF_MEMDEV</code> with the difference that the according window is drawn the first time without using a Memory Device. The WM will automatically use a Memory Device for redrawing. This flag can be used as a replacement of <code>WM_CF_MEMDEV</code> . It typically accelerates the initial rendering of the window, but maintains the advantage of flicker free updates.   |
| <code>WM_SF_INVALID_DRAW</code>     | Internal use.   |
| <code>WM_SF_DELETE</code>           | Internal use.   |
| <code>WM_CF_STATIC</code>           | Window uses a static memory device for redrawing.   |
| <code>WM_CF_MOTION_X</code>         | Window can be moved automatically in X axis.  |
| <code>WM_CF_MOTION_Y</code>         | Window can be moved automatically in Y axis.  |

| Definition                            | Description  |
|---------------------------------------|--|
| <a href="#">WM_CF_GESTURE</a>         | Marks the window to be able to receive gesture messages. This requires gesture support.  |
| <a href="#">WM_CF_ZOOM</a>            | Window can be scaled automatically by multi-touch gesture input.   |
| <a href="#">WM_CF_MOTION_R</a>        | This enables the window to be rotated.   |
| <a href="#">WM_CF_UNTOUCHABLE</a>     | A window created with this flag routes its touch input to its parent. This makes a window 'untouchable'.   |
| <a href="#">WM_CF_APPWIZARD</a>       | Window is an AppWizard object  |
| <a href="#">WM_CF_MEMDEV_CLIPPING</a> | Reactivates the window manager when drawing into memory devices created via <a href="#">WM_CF_MEMDEV</a> . Otherwise it can happen that invisible windows (e.g. a window covered completely by another window) still draws its content into a memory device but the memory device doesn't get drawn to the LCD. With this flag these unnecessary drawing operations can be avoided. Attention, if there is a non transparent window in the foreground, which is smaller than the window in the back, tiling will be used and multiple paint events into the memory device will be performed! |

## 6.1.9 Example

The following example illustrates the difference between using a callback routine for re-drawing the background and not having one. It also shows how to set your own callback function. The example is available as `WM_Redraw.c` in the examples shipped with `emWin`:

```

/*****
 *          SEGGER MICROCONTROLLER SYSTEME GmbH
 *          Solutions for real time microcontroller applications
 *
 *          emWin example code
 *
 *****/
-----
File       : WM_Redraw.c
Purpose    : Demonstrates the redrawing mechanism of the Window Manager
-----
*/
#include "GUI.H"
/*****
 *
 *          Callback routine for background window
 *
 *****/
*/
static void cbBackgroundWin(WM_MESSAGE * pMsg) {
    switch (pMsg->MsgId) {
        case WM_PAINT:
            GUI_Clear();
            break;
        default:
            WM_DefaultProc(pMsg);
    }
}
/*****
 *
 *          Callback routine for foreground window
 *
 *****/
*/
static void cbForegroundWin(WM_MESSAGE * pMsg) {
    switch (pMsg->MsgId) {
        case WM_PAINT:
            GUI_SetBkColor(GUI_GREEN);
            GUI_Clear();
            GUI_DispString("Foreground window");
            break;
        default:
            WM_DefaultProc(pMsg);
    }
}
/*****
 *
 *          Demonstrates the redraw mechanism of emWin
 *
 *****/
*/
static void DemoRedraw(void) {
    GUI_HWIN hWnd;
    while(1) {
        /* Create foreground window */
        hWnd = WM_CreateWindow(10, 10, 100, 100, WM_CF_SHOW, cbForegroundWin, 0);
        /* Show foreground window */
        GUI_Delay(1000);
        /* Delete foreground window */
        WM_DeleteWindow(hWnd);
        GUI_DispStringAt("Background of window has not been redrawn", 10, 10);
    }
}

```



```
/* Wait a while, background will not be redrawn */
GUI_Delay(1000);
GUI_Clear();
/* Set callback for Background window */
WM_SetCallback(WM_HBKWIN, cbBackgroundWin);
/* Create foreground window */
hWnd = WM_CreateWindow(10, 10, 100, 100, WM_CF_SHOW, cbForegroundWin, 0);
/* Show foreground window */
GUI_Delay(1000);
/* Delete foreground window */
WM_DeleteWindow(hWnd);
/* Wait a while, background will be redrawn */
GUI_Delay(1000);
/* Delete callback for Background window */
WM_SetCallback(WM_HBKWIN, 0);
}}
/*****
*
*          main
*
*****/
*/
void main(void) {
    GUI_Init();
    DemoRedraw();
}
```

## 6.2 Widgets (window objects)

Widgets are windows with object-type properties. They are called controls in the Windows environments and make up the elements of the user interface. They can react automatically to certain events. For example, a button can appear in a different state if it is pressed. Widgets have properties which may be changed at any time during their existence. They are typically deleted as soon as they are not used any longer. Similar to windows, widgets are referenced by handles which are returned by the respective create function.











Widgets require the Window Manager. Once a widget is created, it is treated just like any other window. The WM ensures that it is properly displayed (and redrawn) whenever necessary. The use of widgets is not mandatory for applications or user interfaces, but they decrease development time.



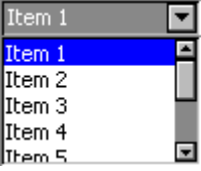
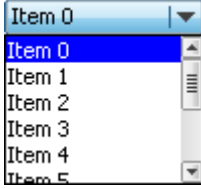

Since widgets are essentially windows it is possible to use most of the Window Manager API functions as well.

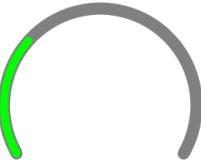
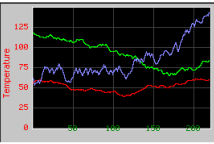



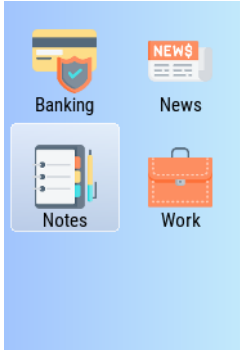
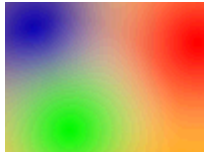

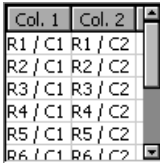
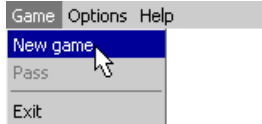
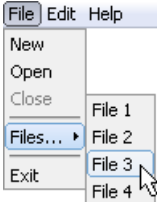
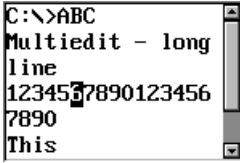
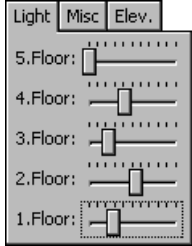
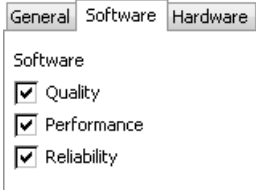
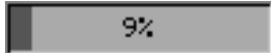



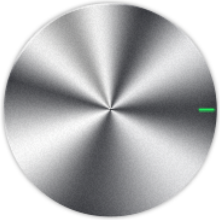

### 6.2.1 Some basics

#### 6.2.1.1 Available widgets

The following table shows the appearance of the currently available widgets. Some of the widgets support skinning. This method of changing the appearance is explained in detail in chapter *Skinning* on page 2509. The second screenshot shows the appearance when skinning is enabled for the widget:

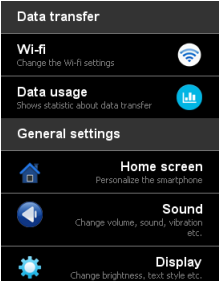
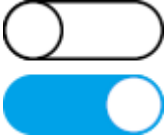

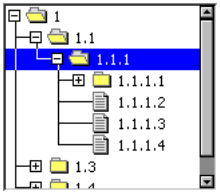

| Name     | Screenshot (classic)  | Screenshot (skinned)   | Description  |
|----------|---|--|--|
| BUTTON   |  |   | Button which can be pressed. Text or bitmaps may be displayed on a button. |
| CHECKBOX |  |   | Check box which may be checked or unchecked.                               |
| DROPDOWN |  |   | Dropdown listbox, opens a listbox when pressed.                            |
| EDIT     |  |  | Single-line edit field which prompts the user to type a number or text.    |
| FRAMEWIN |  |  | Frame window. Creates the typical GUI look.                                |
| GAUGE    |  |  | Gauge widget, basically a radial progress bar.                             |
| GRAPH    |  |  | Graph widget, used to show curves or measured values.                      |
| HEADER   |  |  | Header control, used to manage columns.                                    |

| Name      | Screenshot (classic)  | Screenshot (skinned)   | Description  |
|-----------|---|--|--|
| ICONVIEW  |    |  | <p>Icon view widget. Useful for icon based platforms as found in common hand held devices.</p> |
| IMAGE     |    |  | <p>Image widget. Displays several image formats automatically.</p>                             |
| KEYBOARD  |    |  | <p>Keyboard widget. Screen keyboard for (MULTI)EDIT input.</p>                                 |
| LISTBOX   |    |  | <p>Listbox which highlights items as they are selected by the user.</p>                        |
| LISTVIEW  |  |  | <p>Listview widgets are used to creates tables.</p>  |
| MENU      |  |   | <p>Menu widgets are used to create horizontal and vertical menus.</p>                          |
| MULTIEDIT |  |  | <p>Multiedit widgets are used to edit multiple lines of text.</p>                              |
| MULTIPAGE |  |  | <p>Multipage widgets are used to create dialogs with multiple pages.</p>                       |
| PROGBAR   |  |  | <p>Progress bar used for visualization.</p>  |

| Name      | Screenshot (classic)  | Screenshot (skinned)  | Description   |
|-----------|---|---|---|
| QRCODE    |    |   | QR code.  |
| RADIO     |    | <input checked="" type="radio"/> Option 1<br><input type="radio"/> Option 2<br><input type="radio"/> Option 3 | Radio button which may be selected. Only one button may be selected at a time.  |
| ROTARY    |    |   | Rotary dial widget which can be rotated to return uncountable values.   |
| SCROLLER  |    |   | Smartphone-like scrollbar widget which may be horizontal or vertical.   |
| SLIDER    |   |                             | Slider bar used for changing values.  |
| SPINBOX   |  |                           | Spinning box to display and adjust a specific value.  |
| SWIPELIST |  |   | Swipeable list widgets are used for creating swipeable lists which could be moved by swiping the finger (or any other PID) over the touch screen. |
| SWITCH    |  |   | Switch which can be toggled.  |
| TEXT      |  |   | Static text controls typically used in dialogs.   |
| TREEVIEW  |  |   | Treeview widget for managing hierarchical lists.  |
| WHEEL     |  |   | Scrollable rotating wheel that displays lists of texts and/or bitmaps.  |

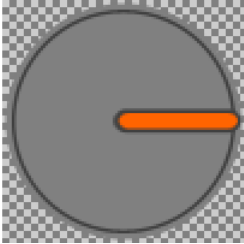
## Obsolete widgets

The following widgets are obsolete and are still included in emWin for compability reasons. The widgets have been replaced with newer versions, which are linked to at the beginning of the section of the widget.

| Name  | Screenshot (classic)  | Screenshot (skinned)  | Description   |
|---|---|---|---|
| <b>KNOB</b><br><b>Replaced by:</b><br>ROTARY        |  |   | Knob widget which can be used to adjust uncountable values.                       |
| <b>LISTWHEEL</b><br><b>Replaced by:</b><br>WHEEL    |  |   | Listwheel widget. The data can be moved and accelerated via pointer input device. |
| <b>SCROLLBAR</b><br><b>Replaced by:</b><br>SCROLLER |  |  | PC-style scrollbar which may be horizontal or vertical.                           |

### 6.2.1.2 Custom widget types

emWin users have the possibility to create custom types of widgets. This can be done using a custom callback function for an existing widget in order to preserve certain functionality. In case it is required to implement a new type of widget it is recommended to use a simple window as starting point and follow the instructions in [AN03002\\_Custom\\_Widget\\_Type.pdf](#) which can also be found in the Doc-folder.

### 6.2.1.3 Understanding the redrawing mechanism

A widget draws itself according to its properties. This is done when `WM_Exec()`, `GUI_Exec()` or `GUI_Delay()` is called. In a multitasking environment, a background task is normally used to call `WM_Exec()` and update the widgets (and all other windows with callback functions).

When a property of a widget is changed, the window of the widget (or part of it) is marked as invalid, but it is not immediately redrawn. Therefore, the section of code executes very fast. The redrawing is done by the WM at a later time or it can be forced by calling `WM_Paint()` for the widget (or `WM_Exec()` until all windows are redrawn).

### 6.2.1.4 How to use widgets

Suppose we would like to display a progress bar. All that is needed is the following code:

```
PROGBAR_Handle hProgBar;
GUI_DispStringAt("Progress bar", 100, 20);
hProgBar = PROGBAR_Create(100, 40, 100, 20, WM_CF_SHOW);
```



The first line reserves memory for the handle of the widget. The last line actually creates the widget. The widget will then automatically be drawn by the Window Manager once `WM_Exec()` is called the next time, what may happen in a separate task.

Member functions are available for each type of widget which allow modifications to their appearance. Once the widget has been created, its properties can be changed by calling its member functions. These functions take the handle of the widget as their first argument. In order to make the progress bar created above show 45% and to change the bar colors from their defaults (dark gray/light gray) to green/red, the following section of code may be used:

```
PROGBAR_SetBarColor(hProgBar, 0, GUI_GREEN);
PROGBAR_SetBarColor(hProgBar, 1, GUI_RED);
PROGBAR_SetValue(hProgBar, 45);
```



### Default configuration

All widgets also have one or more configuration macros which define various default settings such as fonts and colors used. The available configuration options are listed for each widget in their respective sections later in the chapter. The default configurations have to be set prior using the widget. Otherwise, the set properties will not be taken into account.

### How widgets communicate

Widgets are often created as child windows. The parent window may be any type of window, even another widget. A parent window usually needs to be informed whenever something occurs with one of its children in order to ensure synchronization. Child window widgets communicate with their parent window by sending a `WM_NOTIFY_PARENT` message whenever an event occurs. The notification code sent as part of the message depends on the event.

Most widgets have one or more notification codes defining different types of events. The available notification codes for each widget (if any) are listed under their respective sections.

### Skinning

The appearance of a widget can be modified by using the member functions of the respective widget. Some of the widgets support skinning. If skinning is used for a widget the 'skin' determines the appearance of the widget and some of the member functions have no effect. Details can be found in the chapter *Skinning* on page 2509.

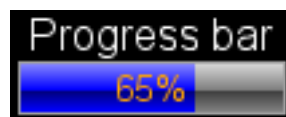

### Dynamic memory usage for widgets

In embedded applications it is usually not very desirable to use dynamic memory at all because of fragmentation effects. There are a number of different strategies that can be used to avoid this, but they all work in a limited way whenever memory areas are referenced by a pointer in the application program. For this reason, emWin uses a different approach: all objects (and all data stored at run-time) are stored in memory areas referenced by a handle. This makes it possible to relocate the allocated memory areas at run-time, thus avoiding the long-term allocation problems which occur when using pointers. All widgets are thus referenced by handles.

### Determine the type of a widget

The type of a widget can be determined by comparing the callback function of a specific widget with the public callback functions of the widget API. The following shows a short example how to determine the type of a widget. In case of overwritten callback functions the method should be adapted:

```
WM_CALLBACK * pCb;
pCb = WM_GetCallback(hWidget);
if (pCb == BUTTON_Callback) {
    // Widget is a button
} else if (pCb == DROPDOWN_Callback) {
    // Widget is a dropdown
} else if (pCb == LISTBOX_Callback) {
    // Widget is a listbox
} else if (...) {
    ...
}
```

This code works only if callback function have not been overwritten. As custom callback functions are used, the code above needs to be adapted.

## 6.2.2 Configuration options

| Type | Macro                    | Default | Description   |
|------|--------------------------|---------|---|
| B    | WIDGET_USE_PARENT_EFFECT | 0       | If set to 1, each 'child widget' of a widget, has the same effect as the parent widget. If for example a listbox needs to create a scroll bar, the new scroll bar has the same effect as the listbox. |
| B    | WIDGET_USE_SCHEME_LARGE  | 0       | If set to 1, the default appearance of the widgets is large sized. That means that all widgets which show text are configured to use large sized default fonts.                                       |
| B    | WIDGET_USE_SCHEME_MEDIUM | 0       | If set to 1, the default appearance of the widgets is medium sized. That means that all widgets which show text are configured to use medium sized default fonts.                                     |
| B    | WIDGET_USE_SCHEME_SMALL  | 1       | If set to 1, the default appearance of the widgets is small sized. That means that all widgets which show text are configured to use small sized default fonts.                                       |
| B    | WIDGET_USE_FLEX_SKIN     | 0       | If set to 1, widgets are drawn using the Flex Skin by default. Detailed information about skinning can be found in the chapter <i>Skinning</i> on page 2509.  |

### WIDGET\_USE\_SCHEME...

The table below shows the default appearance of the widget schemes:

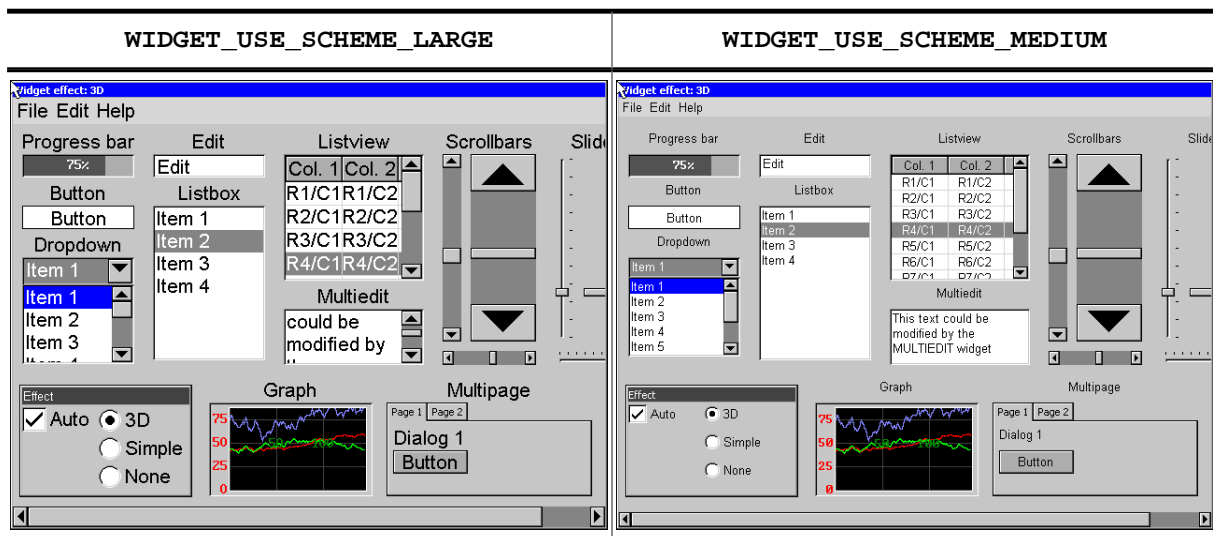



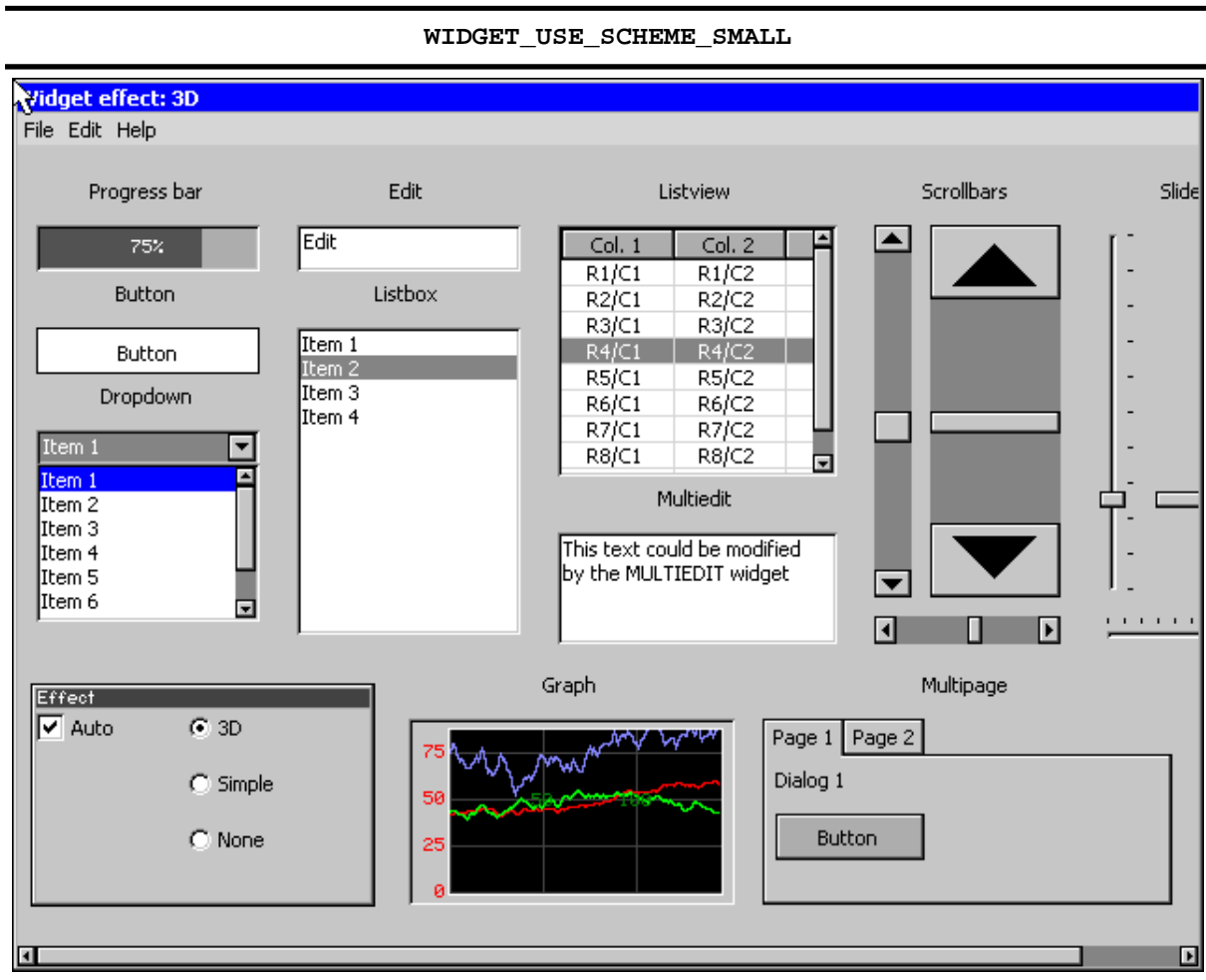

## 6.2.3 Widget IDs

In order to be able to separate all widgets from each other IDs can be assigned. This is usually done by using the according parameter of the `<WIDGET>_Create...()` functions. To make sure that every widget has its unique Id, predefined symbols may be used. The predefined symbols are listed in the subsections of the according widgets. If the predefined symbols do not match ones requirements, custom unique IDs may be defined as follows:

```
#define MY_WIDGET_ID_0 (GUI_ID_USER + 0)
#define MY_WIDGET_ID_1 (GUI_ID_USER + 1)
#define MY_WIDGET_ID_2 (GUI_ID_USER + 2)
#define MY_WIDGET_ID_3 (GUI_ID_USER + 3)
.
.
.
```

## 6.2.4 General widget API

### 6.2.4.1 WM routines used for widgets

Since widgets are essentially windows, they are compatible with any of the Window Manager API routines. The handle of the widget is used as the `hWin` parameter and the widget is treated like any other window. The WM functions most commonly used with widgets are listed as follows:

| Routine                            | Description   |
|------------------------------------|---|
| <code>WM_DeleteWindow()</code>     | Deletes a specified window.                               |
| <code>WM_DisableWindow()</code>    | Disables the specified window.                            |
| <code>WM_EnableMemdev()</code>     | Enables the use of Memory Devices for redrawing a window. |
| <code>WM_InvalidateWindow()</code> | Invalidates a specified window.                           |
| <code>WM_Paint()</code>            | Draws or redraws a specified window immediately.          |

The complete list of WM-related functions can be found in the chapter *The Window Manager (WM)* on page 798.

### 6.2.4.2 Common routines

The table below lists available widget-related routines in alphabetical order. These functions are common to all widgets, and are listed here in order to avoid repetition. Detailed descriptions of the routines follow. The additional member functions available for each widget may be found in later sections.

| Routine                                      | Description   |
|--|---|
| <code>&lt;WIDGET&gt;_Callback()</code>       | Default callback function.  |
| <code>&lt;WIDGET&gt;_CreateIndirect()</code> | Used for automatic creation in dialog boxes.                          |
| <code>&lt;WIDGET&gt;_CreateUser()</code>     | Creates a widget using extra bytes as user data.                      |
| <code>&lt;WIDGET&gt;_GetUserData()</code>    | Retrieves the data set with <code>&lt;WIDGET&gt;_SetUserData</code> . |
| <code>&lt;WIDGET&gt;_SetUserData()</code>    | Sets the extra data of a widget.                                      |
| <code>WIDGET_EnableStreamAuto()</code>       | Enables support for all streamed bitmap formats.                      |
| <code>WIDGET_GetDefaultEffect()</code>       | Returns the default effect used for widgets.                          |
| <code>WIDGET_SetDefaultEffect()</code>       | Sets the default effect used for widgets.                             |
| <code>WIDGET_SetEffect()</code>              | Sets the effect for the given widget.                                 |
| <code>WIDGET_SetFocusable()</code>           | Sets the ability to receive the input focus.                          |

### 6.2.4.2.1 <WIDGET>\_Callback()

#### Description

Default callback function of the widgets to be used from within overwritten callback function.

#### Prototype

```
void <WIDGET>_Callback(WM_MESSAGE * pMsg);
```

| Parameter            | Description                                     |
|----------------------|---|
| <a href="#">pMsg</a> | Pointer to a data structure of type WM_MESSAGE. |

#### Additional information

A default callback function of a widget should not be called directly. It is only to be used from within an overwritten callback function.

This function replaces the default callback of a standard window when overwriting a WIDGET callback function (`WM_DefaultProc()`).

For details about the WM\_MESSAGE data structure, refer to *Messages* on page 812.

### 6.2.4.2.2 <WIDGET>\_CreateIndirect()

#### Description

Creates a widget to be used in dialog boxes.

#### Prototype

```
<WIDGET>_Handle <WIDGET>_CreateIndirect(const GUI_WIDGET_CREATE_INFO * pCreateInfo,
                                         WM_HWIN                    hParent,
                                         int                        x0,
                                         int                        y0,
                                         WM_CALLBACK              * cb);
```

| Parameter                | Description   |
|--------------------------|---|
| <code>pCreateInfo</code> | Pointer to a <code>GUI_WIDGET_CREATE_INFO</code> structure (see below).   |
| <code>hParent</code>     | Handle of parent window.  |
| <code>x0</code>          | Leftmost pixel of the widget (in parent coordinates).   |
| <code>y0</code>          | Topmost pixel of the widget (in parent coordinates).  |
| <code>cb</code>          | Pointer to a callback function. <b>Not used, reserved for future usage.</b> To set a custom callback to the widget, <code>WM_SetCallback()</code> has to be used after the widget has been created. |

#### Additional information

Any widget may be created indirectly by using the appropriate prefix. For example: `BUTTON_CreateIndirect()` to indirectly create a button widget, `CHECKBOX_CreateIndirect()` to indirectly create a check box widget, and so on.

A widget only needs to be created indirectly if it is to be included in a dialog box. Otherwise, it may be created directly by using the `<WIDGET>_Create()` functions. See the chapter *Dialogs* on page 2452 for more information about dialog boxes.

#### Resource table

The `GUI_WIDGET_CREATE_INFO` data structure is defined in the dialog resource table as follows:

```
typedef struct {
    GUI_WIDGET_CREATE_FUNC * pfCreateIndirect;    // Create function
    const char * pName;                          // Text
    (not used for all widgets)
    I16 Id;                                       // Window ID of the widget
    I16
    x0, y0, xSize, ySize; // Size and position of the widget
    I16 Flags;                                    // Widget-specific flags (or 0)
    I32 Para;                                    // Widget-specific parameter (or
    0)
    U32 NumExtraBytes;                          // Number of extra bytes usable
                                           // with <WIDGET>_SetUserData &
                                           // <WIDGET>_GetUserData
} GUI_WIDGET_CREATE_INFO;
```

Widget flags and parameters are optional, and vary depending on the type of widget. The available flags and parameters for each widget (if any) will be listed under the appropriate section later in this chapter.

### 6.2.4.2.3 <WIDGET>\_CreateUser()

#### Description

Creates a widget using extra bytes as user data. This function is similar to the <WIDGET>\_CreateEx() function of the appropriate widget in every case except the additional parameter [NumExtraBytes](#).

#### Prototype

```
<WIDGET>_Handle <WIDGET>_CreateUser(int x0,
                                   int y0,
                                   ... ...,
                                   int Id,
                                   int NumExtraBytes);
```

| Parameter                | Description                           |
|--------------------------|---------------------------------------|
| <a href="#">NumBytes</a> | Number of extra bytes to be allocated |

#### Return value

Handle of the created widget.  
0 if the function fails.

#### Additional information

For more information about the other parameters the appropriate <WIDGET>\_CreateEx() functions can be referred to.

#### 6.2.4.2.4 <WIDGET>\_GetUserData()

##### Description

Retrieves the data set with <WIDGET>\_SetUserData.

##### Prototype

```
int <WIDGET>_GetUserData(<WIDGET>_Handle hObj,
                        void * pDest,
                        int NumBytes);
```

| Parameter             | Description             |
|-----------------------|-------------------------|
| <code>hObj</code>     | Handle of the widget    |
| <code>pDest</code>    | Pointer to buffer       |
| <code>NumBytes</code> | Number of bytes to read |

##### Return value

Number of bytes read.

##### Additional information

The maximum number of bytes returned by this function is the number of extra bytes specified when creating the widget using <WIDGET>\_CreateUser() or <WIDGET>\_CreateIndirect().

### 6.2.4.2.5 <WIDGET>\_SetUserData()

#### Description

Sets the extra data of a widget.

#### Prototype

```
int <WIDGET>_SetUserData(<WIDGET>_Handle hObj,
                        void * pDest,
                        int NumBytes);
```

| Parameter             | Description              |
|-----------------------|--------------------------|
| <code>hObj</code>     | Handle of the widget     |
| <code>pDest</code>    | Pointer to buffer        |
| <code>NumBytes</code> | Number of bytes to write |

#### Return value

Number of bytes written.

#### Additional information

The maximum number of bytes used to store user data is the number of extra bytes specified when creating the widget using `<WIDGET>_CreateUser()` or `<WIDGET>_CreateIndirect()`.

### 6.2.4.2.6 WIDGET\_EnableStreamAuto()

#### Description

Enables drawing of all supported streamed bitmap formats for widgets like ICONVIEW and IMAGE widget.

#### Prototype

```
void WIDGET_EnableStreamAuto(void);
```

#### Additional information

Per default support for drawing all streamed bitmap formats is enabled. To be able to spare ROM that support could be disabled by adding the following line to `GUIConf.h`:

```
#define GUI_USE_STREAMED_BITMAP_AUTO 0
```



#### 6.2.4.2.7 WIDGET\_GetDefaultEffect()

##### Description

Returns the default effect used for widgets.

##### Prototype

```
const WIDGET_EFFECT * WIDGET_GetDefaultEffect(void);
```

##### Return value

The result of the function is a pointer to a WIDGET\_EFFECT structure.

##### Additional information

For more information, refer to *WIDGET\_SetDefaultEffect* on page 998.

### 6.2.4.2.8 WIDGET\_SetDefaultEffect()

#### Description

Sets the default effect used for widgets.

#### Prototype

```
const WIDGET_EFFECT * WIDGET_SetDefaultEffect(const WIDGET_EFFECT * pEffect);
```

#### Parameters

| Parameter            | Description   |
|----------------------|---|
| <code>pEffect</code> | Pointer to a <code>WIDGET_EFFECT</code> structure. See table below. |





| Permitted values for parameter <code>pEffect</code> |  |
|---|--|
| <code>&amp;WIDGET_Effect_3D</code>                  | Sets the default effect to <i>3D</i> .     |
| <code>&amp;WIDGET_Effect_None</code>                | Sets the default effect to <i>None</i> .   |
| <code>&amp;WIDGET_Effect_Simple</code>              | Sets the default effect to <i>Simple</i> . |

#### Return value

Previous used default effect.

#### Additional information

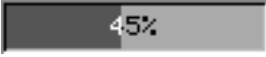
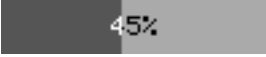
The following table shows the appearance of some widgets in dependence of the used effect:

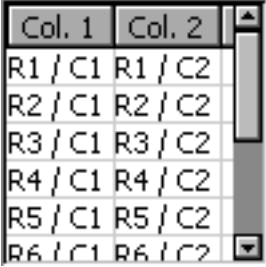
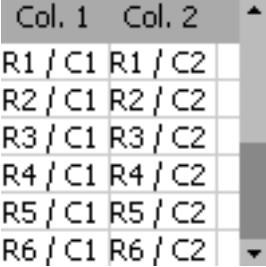
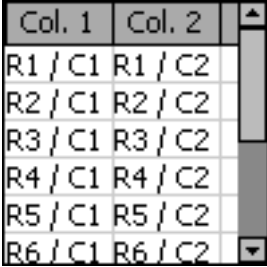
| 3D  | None  | Simple  |
|---|---|---|
|  |  |  |
|  |  |  |
|  |  |  |

### 6.2.4.2.9 WIDGET\_SetEffect()

#### Description

Sets the effect for the given widget.

#### Prototype

```
void WIDGET_SetEffect(          WM_HWIN          hObj,  
                        const WIDGET_EFFECT * pEffect);
```

#### Parameters

| Parameter            | Description  |
|----------------------|--|
| <code>hObj</code>    | Handle of widget.  |
| <code>pEffect</code> | Pointer to a <code>WIDGET_EFFECT</code> structure. For details, refer to <code>WIDGET_GetDefaultEffect</code> on page 998. |

### 6.2.4.2.10 WIDGET\_SetFocusable()

#### Description

Sets the ability to receive the input focus.

#### Prototype

```
void WIDGET_SetFocusable(WM_HWIN hObj,  
                        int State);
```

#### Parameters

| Parameter          | Description       |
|--------------------|-------------------|
| <code>hObj</code>  | Handle of widget. |
| <code>State</code> | (see table below) |

| Permitted values for parameter <code>State</code> |                                       |
|---|---------------------------------------|
| 1   | Widget can receive the input focus.   |
| 0   | Widget can't receive the input focus. |

### 6.2.4.3 User drawn widgets

Some widgets supports owner drawing, for example the LISTBOX widget. If the user draw mode of a widget has been activated a application-defined function of type `WIDGET_DRAW_ITEM_FUNC` will be called to draw the widget (item). The prototype of an application-defined owner draw function should be defined as follows:

#### Prototype

```
int WIDGET_DRAW_ITEM_FUNC(const WIDGET_ITEM_DRAW_INFO * pDrawItemInfo);
```

| Parameter                  | Description  |
|----------------------------|--|
| <code>pDrawItemInfo</code> | Pointer to a <code>WIDGET_ITEM_DRAW_INFO</code> structure. |

#### Elements of structure `WIDGET_ITEM_DRAW_INFO`

| Data type            | Element                | Description   |
|----------------------|------------------------|---|
| <code>WM_HWIN</code> | <code>hWin</code>      | Handle to the widget.   |
| <code>int</code>     | <code>Cmd</code>       | See table below.  |
| <code>int</code>     | <code>ItemIndex</code> | Zero based index of item to be drawn.                             |
| <code>int</code>     | <code>Col</code>       | Zero based column index of item to be drawn.                      |
| <code>int</code>     | <code>x0</code>        | <code>x0</code> window coordinate which is used to draw the item. |
| <code>int</code>     | <code>y0</code>        | <code>y0</code> window coordinate which is used to draw the item. |
| <code>int</code>     | <code>x1</code>        | <code>x1</code> window coordinate which is used to draw the item. |
| <code>int</code>     | <code>y1</code>        | <code>y1</code> window coordinate which is used to draw the item. |

| Permitted values for parameter <code>Cmd</code> |  |
|---|--|
| <code>WIDGET_ITEM_GET_XSIZE</code>              | The function returns the x-size (width) in pixels of the given item.   |
| <code>WIDGET_ITEM_GET_YSIZE</code>              | The function returns the y-size (height) in pixels of the given item.  |
| <code>WIDGET_ITEM_DRAW</code>                   | The function draws the given item at the given position.   |
| <code>WIDGET_DRAW_BACKGROUND</code>             | The background of the widget should be drawn.  |
| <code>WIDGET_DRAW_OVERLAY</code>                | This command is sent after all other drawing operations have been finished and enables the possibility to draw some overlaying items above the widget. |

#### Return value

Depends on the given command.

#### Reaction to commands

The function has to react to the command given in the `WIDGET_ITEM_DRAW_INFO` structure. This can be done in one of 2 ways:

- By calling the appropriate default function supplied by the particular widget (for example, `LISTBOX_OwnerDraw()`)
- By supplying code that reacts accordingly.

## Commands

The commands listed below are supported and should be reacted to by the function. As explained above, the default owner draw function should be called for all not handled functions. This can save code size (for example if the height is the same as the default height) and makes sure that your code stays compatible if additional commands are introduced in future versions of the software.

### **WIDGET\_ITEM\_GET\_XSIZE**

The X-size in pixels of the given item has to be returned.

### **WIDGET\_ITEM\_GET\_YSIZE**

The Y-size (height) in pixels of the given item has to be returned.

### **WIDGET\_ITEM\_DRAW**

The given item has to be drawn. `x0` and `y0` of the `WIDGET_ITEM_DRAW_INFO` structure specify the position of the item in window coordinates. The item has to fill its entire rectangle; the rectangle is defined by the starting position `x0`, `y0` supplied to the function and the sizes returned by the function as reaction to the commands `WIDGET_ITEM_GET_YSIZE`, `WIDGET_ITEM_GET_XSIZE`. It may NOT leave a part of this rectangular area unpainted. It can not paint outside of this rectangular area because the clip rectangle has been set before the function call.

## 6.2.5 BUTTON: Button widget

BUTTON widgets are commonly used as the primary user interface element for touch-screens. If the button has the input focus, it also reacts on the keys `GUI_KEY_SPACE` and `GUI_KEY_ENTER`. Buttons may be displayed with text, as shown below, or with a bitmap.



### Note

All BUTTON-related routines are located in the file(s) `BUTTON*.c`, `BUTTON.h`. All identifiers are prefixed `BUTTON`.

### Skinning...



...is available for this widget. The screenshot above shows the widget using the default skin. Details can be found in the chapter *Skinning* on page 2509.

### 6.2.5.1 Configuration options

| Type | Macro                                  | Default   | Description   |
|------|--|---|---|
| N    | <code>BUTTON_3D_MOVE_X</code>          | 1   | Number of pixels that text/bitmap moves in horizontal direction in pressed state. |
| N    | <code>BUTTON_3D_MOVE_Y</code>          | 1   | Number of pixels that text/bitmap moves in vertical direction in pressed state.   |
| N    | <code>BUTTON_ALIGN_DEFAULT</code>      | <code>GUI_TA_HCENTER</code>   <code>GUI_TA_VCENTER</code> | Alignment used to display the button text.  |
| N    | <code>BUTTON_BKCOLOR0_DEFAULT</code>   | <code>0xAAAAAA</code>                                     | Background color, unpressed state.  |
| N    | <code>BUTTON_BKCOLOR1_DEFAULT</code>   | <code>GUI_WHITE</code>                                    | Background color, pressed state.  |
| N    | <code>BUTTON_FOCUSCOLOR_DEFAULT</code> | <code>GUI_BLACK</code>                                    | Default color for rendering the focus rectangle.                                  |
| S    | <code>BUTTON_FONT_DEFAULT</code>       | <code>&amp;GUI_Font13_1</code>                            | Font used for button text.  |
| B    | <code>BUTTON_REACT_ON_LEVEL</code>     | 0   | See description below.  |
| N    | <code>BUTTON_TEXTCOLOR0_DEFAULT</code> | <code>GUI_BLACK</code>                                    | Text color, unpressed state.  |
| N    | <code>BUTTON_TEXTCOLOR1_DEFAULT</code> | <code>GUI_BLACK</code>                                    | Text color, pressed state.  |

#### 6.2.5.1.1 BUTTON\_REACT\_ON\_LEVEL

There are 2 ways for a BUTTON widget to handle PID events.

The default way of handling PID events for the BUTTON widget is reacting on level changes only. This means BUTTON widgets react only if the PID state changes on the BUTTON. This can be enabled by calling the function `BUTTON_SetReactOnLevel()`.

The obsolete (and former default) way is recognizing and processing all PID events which happen in the BUTTON area. This includes PIDs moved in the BUTTON area in pressed state. The BUTTON widget would "accept" the pressed state and change its state accordingly. The disadvantage of this mode is that BUTTONS may be clicked by mistake. This logic can be enabled either by defining `BUTTON_REACT_ON_LEVEL` with 0 or by calling the function `BUTTON_SetReactOnTouch()`.

### Example for an unwanted BUTTON click

This example shows how a BUTTON widget may be mistakenly clicked without the BUTTON being configured to react on level. In the example the mouse is clicked once. The click closes the expanded DROPDOWN and subsequently clicks the BUTTON behind.

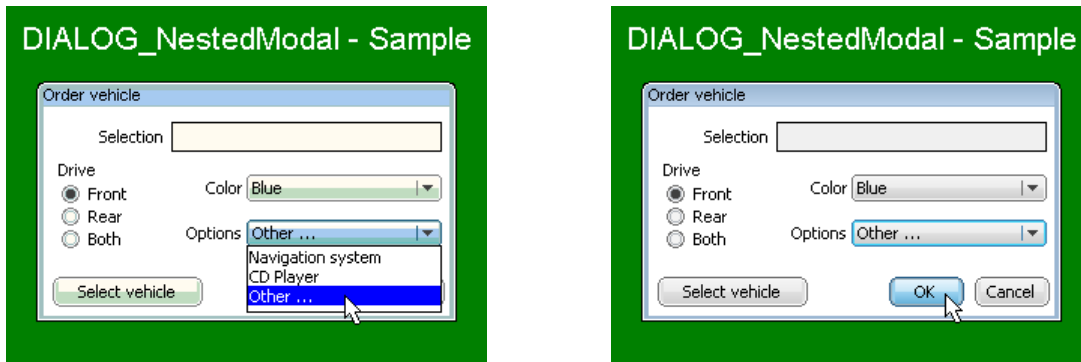

#### 6.2.5.1.2 BUTTON\_BKCOLOR0\_DEFAULT, BUTTON\_BKCOLOR1\_DEFAULT

The default for the BUTTON widget is to use a white background in the pressed state. This has been done purposely because it makes it very obvious that the button is pressed, on any kind of display. If you want the background color of the BUTTON widget to be the same in both its pressed and unpressed states, change `BUTTON_BKCOLOR1_DEFAULT` to `BUTTON_BKCOLOR0_DEFAULT`.

#### 6.2.5.2 Predefined IDs

The following symbols define IDs which may be used to make BUTTON widgets distinguishable from creation.

```
#define GUI_ID_BUTTON0    0x170
#define GUI_ID_BUTTON1    0x171
#define GUI_ID_BUTTON2    0x172
#define GUI_ID_BUTTON3    0x173
#define GUI_ID_BUTTON4    0x174
#define GUI_ID_BUTTON5    0x175
#define GUI_ID_BUTTON6    0x176
#define GUI_ID_BUTTON7    0x177
#define GUI_ID_BUTTON8    0x178
#define GUI_ID_BUTTON9    0x179
```

#### 6.2.5.3 Notification codes

The following events are sent from a BUTTON widget to its parent window as part of a `WM_NOTIFY_PARENT` message:

| Message                                | Description  |
|--|--|
| <code>WM_NOTIFICATION_CLICKED</code>   | BUTTON has been clicked.   |
| <code>WM_NOTIFICATION_RELEASED</code>  | BUTTON has been released.  |
| <code>WM_NOTIFICATION_MOVED_OUT</code> | BUTTON has been clicked and pointer has been moved out of the BUTTON widget without releasing. |



### 6.2.5.4 Keyboard reaction

The BUTTON widget reacts to the following keys if it has the input focus:

| Key           | Reaction   |
|---------------|--|
| GUI_KEY_ENTER | If the key is pressed, the BUTTON reacts as it has been pressed and immediately released.                                  |
| GUI_KEY_SPACE | If the key is pressed, the BUTTON state changes to pressed. If the key is released, the BUTTON state changes to unpressed. |

### 6.2.5.5 BUTTON API

The table below lists the available emWin BUTTON-related routines in alphabetical order. Detailed descriptions of the routines follow.

#### Functions

| Routine                                   | Description  |
|---|--|
| <code>BUTTON_Create()</code>              | Creates a BUTTON widget. (Obsolete)  |
| <code>BUTTON_CreateAsChild()</code>       | Creates a BUTTON widget as a child window. (Obsolete)                              |
| <code>BUTTON_CreateEx()</code>            | Creates a BUTTON widget.   |
| <code>BUTTON_CreateIndirect()</code>      | Creates a BUTTON widget from a resource table entry.                               |
| <code>BUTTON_CreateUser()</code>          | Creates a BUTTON widget using extra bytes as user data.                            |
| <code>BUTTON_GetBitmap()</code>           | Returns a pointer to the optional BUTTON bitmap.                                   |
| <code>BUTTON_GetBkColor()</code>          | Returns the background color of the given BUTTON widget.                           |
| <code>BUTTON_GetDefaultBkColor()</code>   | Returns the default background color for BUTTON widgets.                           |
| <code>BUTTON_GetDefaultFont()</code>      | Returns the pointer to the font used to display the text of BUTTON widgets.        |
| <code>BUTTON_GetDefaultTextAlign()</code> | Returns the default text alignment used to display the text of BUTTON widgets.     |
| <code>BUTTON_GetDefaultTextColor()</code> | Returns the default text color used to display the text of BUTTON widgets.         |
| <code>BUTTON_GetFont()</code>             | Returns a pointer to the font used to display the text of the given BUTTON widget. |
| <code>BUTTON_GetText()</code>             | Retrieves the text of the specified BUTTON widget.                                 |
| <code>BUTTON_GetTextAlign()</code>        | Returns the alignment of the BUTTON text.  |
| <code>BUTTON_GetTextColor()</code>        | Returns the text color of the given BUTTON widget.                                 |
| <code>BUTTON_GetUserData()</code>         | Retrieves the data set with <code>BUTTON_SetUserData()</code> .                    |
| <code>BUTTON_IsPressed()</code>           | Returns if the BUTTON is pressed or not.   |
| <code>BUTTON_SetBitmap()</code>           | Sets the bitmap used when displaying the BUTTON.                                   |
| <code>BUTTON_SetBitmapEx()</code>         | Sets the bitmap used when displaying the BUTTON.                                   |

| Routine                                    | Description   |
|--|---|
| <code>BUTTON_SetBkColor()</code>           | Sets the background color of a BUTTON widget.   |
| <code>BUTTON_SetBMP()</code>               | Sets the bitmap to be displayed on the specified BUTTON widget.                                 |
| <code>BUTTON_SetBMPEX()</code>             | Sets the bitmap to be displayed at the specified position on the given BUTTON widget.           |
| <code>BUTTON_SetDefaultBkColor()</code>    | Sets the default background color used for BUTTON widgets.                                      |
| <code>BUTTON_SetDefaultFocusColor()</code> | Sets the default focus rectangle color for BUTTON widgets. (Obsolete)                           |
| <code>BUTTON_SetDefaultFont()</code>       | Sets a pointer to a <code>GUI_FONT</code> structure used to display the text of BUTTON widgets. |
| <code>BUTTON_SetDefaultTextAlign()</code>  | Sets the default text alignment used to display the text of BUTTON widgets.                     |
| <code>BUTTON_SetDefaultTextColor()</code>  | Sets the default text color used to display the text of BUTTON widgets.                         |
| <code>BUTTON_SetFocusColor()</code>        | Sets the color used to render the focus rectangle of the BUTTON widget. (Obsolete)              |
| <code>BUTTON_SetFocusable()</code>         | Sets the ability to receive the input focus.  |
| <code>BUTTON_SetFont()</code>              | Sets the font of the BUTTON widget.   |
| <code>BUTTON_SetFrameColor()</code>        | Sets the color of BUTTON frame. (Obsolete)  |
| <code>BUTTON_SetPressed()</code>           | Sets the state of the button to pressed or unpressed.   |
| <code>BUTTON_SetReactOnLevel()</code>      | Sets all BUTTON widgets to react on level changes of the PID.                                   |
| <code>BUTTON_SetReactOnTouch()</code>      | Sets all BUTTON widgets to react on touch events.   |
| <code>BUTTON_SetStreamedBitmap()</code>    | Sets the streamed bitmap used when displaying the BUTTON widget.                                |
| <code>BUTTON_SetStreamedBitmapEx()</code>  | Sets the streamed bitmap used when displaying the BUTTON widget.                                |
| <code>BUTTON_SetText()</code>              | Sets the text.  |
| <code>BUTTON_SetTextAlign()</code>         | Sets the text alignment of the BUTTON widget.   |
| <code>BUTTON_SetTextColor()</code>         | Set the color(s) for the text.  |
| <code>BUTTON_SetTextOffset()</code>        | Adjusts the position of the BUTTON text considering the current text alignment setting.         |
| <code>BUTTON_SetToggleMode()</code>        | Enables toggle mode for the BUTTON widget.  |
| <code>BUTTON_SetUserData()</code>          | Sets the extra data of a BUTTON widget.   |
| <code>BUTTON_Toggle()</code>               | Toggles the state of the given BUTTON.  |

## Defines

| Group of defines                   | Description                       |
|------------------------------------|-----------------------------------|
| <code>BUTTON_bitmap_indexes</code> | Bitmap indexes for BUTTON widget. |
| <code>BUTTON_color_indexes</code>  | Color indexes for BUTTON widget.  |

## 6.2.5.5.1 Functions

### 6.2.5.5.1.1 BUTTON\_Create()

#### Note

This function is **deprecated**, `BUTTON_CreateEx()` should be used instead.

#### Description

Creates a BUTTON widget of a specified size at a specified location.

#### Prototype

```
BUTTON_Handle BUTTON_Create(int x0,
                             int y0,
                             int xSize,
                             int ySize,
                             int Id,
                             int Flags);
```

#### Parameters

| Parameter          | Description  |
|--------------------|--|
| <code>x0</code>    | Leftmost pixel of the button (in parent coordinates).  |
| <code>y0</code>    | Topmost pixel of the button (in parent coordinates).   |
| <code>xSize</code> | Horizontal size of the button (in pixels).   |
| <code>ySize</code> | Vertical size of the button (in pixels).   |
| <code>Id</code>    | ID to be returned when button is pressed.  |
| <code>Flags</code> | Window create flags. Typically <code>WM_CF_SHOW</code> in order to make the widget visible immediately (refer to <i>Window create flags</i> on page 977 for a list of available parameter values). |

#### Return value

Handle of the created BUTTON widget; 0 if the function fails.

### 6.2.5.5.1.2 BUTTON\_CreateAsChild()

#### Note

This function is **deprecated**, `BUTTON_CreateEx()` should be used instead.

#### Description

Creates a `BUTTON` widget as a child window.

#### Prototype

```
BUTTON_Handle BUTTON_CreateAsChild(int    x0,
                                     int    y0,
                                     int    xSize,
                                     int    ySize,
                                     WM_HWIN hParent,
                                     int    Id,
                                     int    Flags);
```

#### Parameters

| Parameter            | Description  |
|----------------------|--|
| <code>x0</code>      | Leftmost pixel of the button (in parent coordinates).  |
| <code>y0</code>      | Topmost pixel of the button (in parent coordinates).   |
| <code>xSize</code>   | Horizontal size of the button (in pixels).   |
| <code>ySize</code>   | Vertical size of the button (in pixels).   |
| <code>hParent</code> | Handle of parent window. If 0, the <code>BUTTON</code> widget will be a child of the desktop (top-level window). |
| <code>Id</code>      | ID to be returned when button is pressed.  |
| <code>Flags</code>   | Window create flags (see <i>Window create flags</i> on page 977).  |

#### Return value

Handle of the created `BUTTON` widget; 0 if the function fails.

### 6.2.5.5.1.3 BUTTON\_CreateEx()

#### Description

Creates a `BUTTON` widget of a specified size at a specified location.

#### Prototype

```
BUTTON_Handle BUTTON_CreateEx(int    x0,
                               int    y0,
                               int    xSize,
                               int    ySize,
                               WM_HWIN hParent,
                               int    WinFlags,
                               int    ExFlags,
                               int    Id);
```

#### Parameters

| Parameter             | Description  |
|-----------------------|--|
| <code>x0</code>       | Leftmost pixel of the button (in parent coordinates).  |
| <code>y0</code>       | Topmost pixel of the button (in parent coordinates).   |
| <code>xSize</code>    | Horizontal size of the button (in pixels).   |
| <code>ySize</code>    | Vertical size of the button (in pixels).   |
| <code>hParent</code>  | Handle of parent window. If 0, the <code>BUTTON</code> widget will be a child of the desktop (top-level window).   |
| <code>WinFlags</code> | Window create flags. Typically <code>WM_CF_SHOW</code> in order to make the widget visible immediately (refer to <i>Window create flags</i> on page 977 for a list of available parameter values). |
| <code>ExFlags</code>  | Not used yet, reserved for future use.   |
| <code>Id</code>       | Window ID of the widget.   |

#### Return value

Handle of the created `BUTTON` widget; 0 if the function fails.

#### Additional information

If the possibility of storing user data is a matter the function `BUTTON_CreateUser()` should be used instead.

#### 6.2.5.5.1.4 **BUTTON\_CreateIndirect()**

##### **Description**

The prototype of this function is explained at the beginning of this chapter. Details can be found in the description of the function `<WIDGET>_CreateIndirect()` on page 992. The elements `Flags` and `Para` of the according `GUI_WIDGET_CREATE_INFO` structure are not used.

### 6.2.5.5.1.5 BUTTON\_CreateUser()

#### Description

Prototype explained at the beginning of the chapter as `<WIDGET>_CreateUser()` on page 993. For a detailed description of the parameters the function `BUTTON_CreateEx()` can be referred to.

### 6.2.5.5.1.6 BUTTON\_GetBitmap()

#### Description

Returns a pointer to the optional BUTTON bitmap.

#### Prototype

```
GUI_BITMAP *BUTTON_GetBitmap(BUTTON_Handle hObj,  
                             unsigned int  Index);
```

#### Parameters

| Parameter             | Description  |
|-----------------------|--|
| <a href="#">hObj</a>  | Handle of BUTTON widget.   |
| <a href="#">Index</a> | See <i>BUTTON bitmap indexes</i> on page 1050 for a full list of permitted values. |

#### Return value

Pointer to the bitmap, 0 if no bitmap exists.

#### Additional information

For details about how to set a button bitmap, refer to `BUTTON_SetBitmap()` and `BUTTON_SetBitmapEx()`.



### 6.2.5.5.1.7 BUTTON\_GetBkColor()

#### Description

Returns the background color of the given BUTTON widget.

#### Prototype

```
GUI_COLOR BUTTON_GetBkColor(BUTTON_Handle hObj,  
                             unsigned int  Index);
```

#### Parameters

| Parameter             | Description   |
|-----------------------|---|
| <a href="#">hObj</a>  | Handle of BUTTON widget.  |
| <a href="#">Index</a> | See <i>BUTTON color indexes</i> on page 1051 for a full list of permitted values. |

#### Return value

Background color of the given BUTTON widget.

### 6.2.5.5.1.8 BUTTON\_GetDefaultBkColor()

#### Description

Returns the default background color for BUTTON widgets.

#### Prototype

```
GUI_COLOR BUTTON_GetDefaultBkColor(unsigned Index);
```

#### Parameters

| Parameter             | Description   |
|-----------------------|---|
| <a href="#">Index</a> | See <i>BUTTON color indexes</i> on page 1051 for a full list of permitted values. |

#### Return value

Default background color for BUTTON widgets.

### 6.2.5.5.1.9 BUTTON\_GetDefaultFont()

#### Description

Returns the pointer to the font used to display the text of BUTTON widgets.

#### Prototype

```
GUI_FONT *BUTTON_GetDefaultFont(void);
```

#### Return value

Pointer to the font used to display the text of BUTTON widgets.

### 6.2.5.5.1.10 BUTTON\_GetDefaultTextAlign()

#### Description

Returns the default text alignment used to display the text of BUTTON widgets.

#### Prototype

```
int BUTTON_GetDefaultTextAlign(void);
```

#### Return value

Default text alignment used to display the text of BUTTON widgets.

### 6.2.5.5.1.11 BUTTON\_GetDefaultTextColor()

#### Description

Returns the default text color used to display the text of BUTTON widgets.

#### Prototype

```
GUI_COLOR BUTTON_GetDefaultTextColor(unsigned Index);
```

#### Parameters

| Parameter             | Description   |
|-----------------------|---|
| <a href="#">Index</a> | See <i>BUTTON color indexes</i> on page 1051 for a full list of permitted values. |

#### Return value

Default text alignment used to display the text of BUTTON widgets.

### 6.2.5.5.1.12 BUTTON\_GetFont()

#### Description

Returns a pointer to the font used to display the text of the given BUTTON widget.

#### Prototype

```
GUI_FONT *BUTTON_GetFont(BUTTON_Handle hObj);
```

#### Parameters

| Parameter            | Description              |
|----------------------|--------------------------|
| <a href="#">hObj</a> | Handle of BUTTON widget. |

#### Return value

Pointer to the font used to display the text of the given BUTTON widget.

### 6.2.5.5.1.13 BUTTON\_GetText()

#### Description

Retrieves the text of the specified BUTTON widget.

#### Prototype

```
void BUTTON_GetText(BUTTON_Handle hObj,  
                   char * pBuffer,  
                   int MaxLen);
```

#### Parameters

| Parameter            | Description              |
|----------------------|--------------------------|
| <code>hObj</code>    | Handle of BUTTON widget. |
| <code>pBuffer</code> | Pointer to buffer.       |
| <code>MaxLen</code>  | Size of buffer.          |

#### 6.2.5.5.1.14 BUTTON\_GetTextAlign()

##### Description

Returns the alignment of the BUTTON text.

##### Prototype

```
int BUTTON_GetTextAlign(BUTTON_Handle hObj);
```

##### Parameters

| Parameter            | Description              |
|----------------------|--------------------------|
| <a href="#">hObj</a> | Handle of BUTTON widget. |

##### Return value

Alignment of the BUTTON text.



### 6.2.5.5.1.15 BUTTON\_GetTextColor()

#### Description

Returns the text color of the given BUTTON widget.

#### Prototype

```
GUI_COLOR BUTTON_GetTextColor(BUTTON_Handle hObj,  
                               unsigned int  Index);
```

#### Parameters

| Parameter             | Description   |
|-----------------------|---|
| <a href="#">hObj</a>  | Handle of BUTTON widget.  |
| <a href="#">Index</a> | See <i>BUTTON color indexes</i> on page 1051 for a full list of permitted values. |

#### Return value

Text color of the given BUTTON widget.

### 6.2.5.5.1.16 **BUTTON\_GetUserData()**

#### **Description**

Prototype explained at the beginning of the chapter as `<WIDGET>_GetUserData()` on page 994.

### 6.2.5.5.1.17 BUTTON\_IsPressed()

#### Description

Returns if the BUTTON is pressed or not.

#### Prototype

```
unsigned BUTTON_IsPressed(BUTTON_Handle hObj);
```

#### Parameters

| Parameter            | Description              |
|----------------------|--------------------------|
| <a href="#">hObj</a> | Handle of BUTTON widget. |

#### Return value

- 1 if the button is pressed.
- 0 if the button is not pressed.

### 6.2.5.5.1.18 BUTTON\_SetBitmap()

#### Description

Sets the bitmap(s) to be used when displaying a specified BUTTON widget.

#### Prototype

```
void BUTTON_SetBitmap(    BUTTON_Handle  hObj,
                        unsigned int   Index,
                        const GUI_BITMAP * pBitmap);
```

#### Parameters

| Parameter               | Description  |
|-------------------------|--|
| <a href="#">hObj</a>    | Handle of BUTTON widget.   |
| <a href="#">Index</a>   | See <i>BUTTON bitmap indexes</i> on page 1050 for a full list of permitted values. |
| <a href="#">pBitmap</a> | Pointer to the bitmap structure.   |

#### Return value

If only a bitmap for the unpressed state is set the button will show it also when it is pressed or disabled. To deactivate a previously set bitmap, NULL has to be passed as [pBitmap](#).

### 6.2.5.5.1.19 BUTTON\_SetBitmapEx()

#### Description

Sets the bitmap(s) to be used when displaying a specified BUTTON widget.

#### Prototype

```
void BUTTON_SetBitmapEx(    BUTTON_Handle  hObj,
                           unsigned int   Index,
                           const GUI_BITMAP * pBitmap,
                           int            x,
                           int            y);
```

#### Parameters

| Parameter               | Description  |
|-------------------------|--|
| <a href="#">hObj</a>    | Handle of BUTTON widget.   |
| <a href="#">Index</a>   | See <i>BUTTON bitmap indexes</i> on page 1050 for a full list of permitted values. |
| <a href="#">pBitmap</a> | Pointer to the bitmap structure.   |
| <a href="#">x</a>       | X-position for the bitmap relative to the button.                                  |
| <a href="#">y</a>       | Y-position for the bitmap relative to the button.                                  |

#### Return value

If only a bitmap for the unpressed state is set the BUTTON widget will show it also when it is pressed or disabled.

### 6.2.5.5.1.20 BUTTON\_SetBkColor()

#### Description

Sets the background color of a BUTTON widget.

#### Prototype

```
void BUTTON_SetBkColor(BUTTON_Handle hObj,  
                      unsigned int  Index,  
                      GUI_COLOR    Color);
```

#### Parameters

| Parameter             | Description   |
|-----------------------|---|
| <a href="#">hObj</a>  | Handle of BUTTON widget.  |
| <a href="#">Index</a> | See <i>BUTTON color indexes</i> on page 1051 for a full list of permitted values. |
| <a href="#">Color</a> | Background color to be set.   |

### 6.2.5.5.1.21 BUTTON\_SetBMP()

#### Description

Sets the bitmap to be displayed on the specified BUTTON widget.

#### Prototype

```
void BUTTON_SetBMP(      BUTTON_Handle  hObj,
                        unsigned int   Index,
                        const void     * pBitmap);
```

#### Parameters

| Parameter               | Description  |
|-------------------------|--|
| <a href="#">hObj</a>    | Handle of BUTTON widget.   |
| <a href="#">Index</a>   | See <i>BUTTON bitmap indexes</i> on page 1050 for a full list of permitted values. |
| <a href="#">pBitmap</a> | Pointer to bitmap file data.   |

#### Additional information

If a bitmap was set only for the unpressed state, it will be also displayed in pressed or disabled state. For additional information regarding bitmap files, refer to *BMP file support* on page 426.

### 6.2.5.5.1.22 BUTTON\_SetBMPEX()

#### Description

Sets the bitmap to be displayed at the specified position on the given BUTTON widget.

#### Prototype

```
void BUTTON_SetBMPEX(    BUTTON_Handle  hObj,
                        unsigned int   Index,
                        const void     * pBitmap,
                        int             x,
                        int             y);
```

#### Parameters

| Parameter               | Description  |
|-------------------------|--|
| <a href="#">hObj</a>    | Handle of BUTTON widget.   |
| <a href="#">Index</a>   | See <i>BUTTON bitmap indexes</i> on page 1050 for a full list of permitted values. |
| <a href="#">pBitmap</a> | Pointer to bitmap file data  |
| <a href="#">x</a>       | X-position for the bitmap relative to the button.                                  |
| <a href="#">y</a>       | Y-position for the bitmap relative to the button.                                  |

#### Additional information

If only a bitmap for the unpressed state is set the BUTTON widget will show it also when it is pressed or disabled. For additional information regarding bitmap files, refer to *BMP file support* on page 426.



### 6.2.5.5.1.23 BUTTON\_SetDefaultBkColor()

#### Description

Sets the default background color used for BUTTON widgets.

#### Prototype

```
void BUTTON_SetDefaultBkColor(GUI_COLOR Color,  
                             unsigned Index);
```

#### Parameters

| Parameter | Description   |
|-----------|---|
| Color     | Color to be used.   |
| Index     | See <i>BUTTON color indexes</i> on page 1051 for a full list of permitted values. |

### 6.2.5.5.1.24 BUTTON\_SetDefaultFocusColor()

#### Note

This function is **deprecated** and only works in conjunction with the classic skin (`BUTTON_SetSkinClassic()`). Skinning props should be used instead which can be set via `BUTTON_SetSkinFlexProps()`.

#### Description

Sets the default focus rectangle color for BUTTON widgets.

#### Prototype

```
GUI_COLOR BUTTON_SetDefaultFocusColor(GUI_COLOR Color);
```

#### Parameters

| Parameter          | Description                                  |
|--------------------|--|
| <code>Color</code> | Default color to be used for BUTTON widgets. |

#### Return value

Previous default focus rectangle color.

#### Additional information

For more information, refer to `BUTTON_SetFocusColor()`.

### 6.2.5.5.1.25 BUTTON\_SetDefaultFont()

#### Description

Sets a pointer to a `GUI_FONT` structure used to display the text of `BUTTON` widgets.

#### Prototype

```
void BUTTON_SetDefaultFont(const GUI_FONT * pFont);
```

#### Parameters

| Parameter          | Description  |
|--------------------|--|
| <code>pFont</code> | Pointer to <code>GUI_FONT</code> structure to be used. |

### 6.2.5.5.1.26 BUTTON\_SetDefaultTextAlign()

#### Description

Sets the default text alignment used to display the text of BUTTON widgets.

#### Prototype

```
void BUTTON_SetDefaultTextAlign(int Align);
```

#### Parameters

| Parameter          | Description  |
|--------------------|--|
| <code>Align</code> | Text alignment mode. List of flags can be found under <i>Text alignment flags</i> on page 252. |

### 6.2.5.5.1.27 BUTTON\_SetDefaultTextColor()

#### Description

Sets the default text color used to display the text of BUTTON widgets.

#### Prototype

```
void BUTTON_SetDefaultTextColor(GUI_COLOR Color,  
                               unsigned Index);
```

#### Parameters

| Parameter | Description   |
|-----------|---|
| Color     | Default text color to be used.  |
| Index     | See <i>BUTTON color indexes</i> on page 1051 for a full list of permitted values. |

### 6.2.5.5.1.28 BUTTON\_SetFocusColor()

#### Note

This function is **deprecated** and only works in conjunction with the classic skin (`BUTTON_SetSkinClassic()`). Skinning props should be used instead which can be set via `BUTTON_SetSkinFlexProps()`.

| Before  | After   |
|---|---|
|  |  |

#### Description

Sets the color used to render the focus rectangle of the BUTTON widget.

#### Prototype

```
GUI_COLOR BUTTON_SetFocusColor(BUTTON_Handle hObj,
                               GUI_COLOR    Color);
```

#### Parameters

| Parameter          | Description  |
|--------------------|--|
| <code>hObj</code>  | Handle of BUTTON widget.                               |
| <code>Color</code> | <code>Color</code> to be used for the focus rectangle. |

#### Return value

Previous color of the focus rectangle.

#### Additional information

The focus rectangle is only visible if the widget has the input focus.

### 6.2.5.5.1.29 BUTTON\_SetFocusable()

#### Description

Sets the ability to receive the input focus.

#### Prototype

```
void BUTTON_SetFocusable(BUTTON_Handle hObj,  
                        int State);
```

#### Parameters

| Parameter             | Description              |
|-----------------------|--------------------------|
| <a href="#">hObj</a>  | Handle of BUTTON widget. |
| <a href="#">State</a> | See table below.         |

| Permitted values for parameter <a href="#">Index</a> |                                      |
|--|--------------------------------------|
| 1  | Button can receive the input focus   |
| 0  | Button can't receive the input focus |

### 6.2.5.5.1.30 BUTTON\_SetFont()

#### Description

Sets the font of the BUTTON widget.

#### Prototype

```
void BUTTON_SetFont(      BUTTON_Handle  hObj,  
                        const GUI_FONT  * pfont);
```

#### Parameters

| Parameter          | Description              |
|--------------------|--------------------------|
| <code>hObj</code>  | Handle of BUTTON widget. |
| <code>pFont</code> | Pointer to the font.     |

#### Additional information

If no font is selected, `BUTTON_FONT_DEF` will be used.



### 6.2.5.5.1.31 BUTTON\_SetFrameColor()

#### Note

This function is **deprecated** and only works in conjunction with the classic skin (`BUTTON_SetSkinClassic()`). Skinning props should be used instead which can be set via `BUTTON_SetSkinFlexProps()`.

#### Description

Sets the color of BUTTON frame.

#### Prototype

```
void BUTTON_SetFrameColor(BUTTON_Handle hObj,  
                          GUI_COLOR    Color);
```

#### Parameters

| Parameter          | Description                      |
|--------------------|----------------------------------|
| <code>hObj</code>  | Handle of BUTTON widget.         |
| <code>Color</code> | <code>Color</code> of the frame. |

### 6.2.5.5.1.32 BUTTON\_SetPressed()

#### Description

Sets the state of the button to pressed or unpressed.

#### Prototype

```
void BUTTON_SetPressed(BUTTON_Handle hObj,  
                      int State);
```

#### Parameters

| Parameter          | Description   |
|--------------------|---|
| <code>hObj</code>  | Handle of BUTTON widget.                            |
| <code>State</code> | <code>State</code> , 1 for pressed, 0 for unpressed |

### 6.2.5.5.1.33 `BUTTON_SetReactOnLevel()`

#### **Description**

Sets all `BUTTON` widgets to react on level changes of the PID.

#### **Prototype**

```
void BUTTON_SetReactOnLevel(void);
```

#### **Additional information**

Alternatively to this function the configuration option `BUTTON_REACT_ON_LEVEL` can be used.

### 6.2.5.5.1.34 **BUTTON\_SetReactOnTouch()**

#### **Description**

Sets all BUTTON widgets to react on touch events.

#### **Prototype**

```
void BUTTON_SetReactOnTouch(void);
```

#### **Additional information**

The default behavior of BUTTON widgets is reacting on touch events.

### 6.2.5.5.1.35 BUTTON\_SetStreamedBitmap()

#### Description

Sets the streamed bitmap(s) to be used when displaying a specified BUTTON widget.

#### Prototype

```
void BUTTON_SetStreamedBitmap(    BUTTON_Handle    hObj,
                                unsigned int    Index,
                                const GUI_BITMAP_STREAM * pBitmap);
```

#### Parameters

| Parameter               | Description  |
|-------------------------|--|
| <a href="#">hObj</a>    | Handle of BUTTON widget.   |
| <a href="#">Index</a>   | See <i>BUTTON bitmap indexes</i> on page 1050 for a full list of permitted values. |
| <a href="#">pBitmap</a> | Pointer to a bitmap stream.  |

#### Additional information

For details about streamed bitmaps, refer to *Drawing streamed bitmaps* on page 331.

#### Example

```
BUTTON_SetStreamedBitmap(hButton, BUTTON_CI_UNPRESSED, (const GUI_BITMAP_STREAM*)acImage);
```

### 6.2.5.5.1.36 BUTTON\_SetStreamedBitmapEx()

#### Description

Sets the streamed bitmap(s) to be used when displaying the specified BUTTON widget.

#### Prototype

```
void BUTTON_SetStreamedBitmapEx(    BUTTON_Handle    hObj,
                                   unsigned int          Index,
                                   const GUI_BITMAP_STREAM * pBitmap,
                                   int                    x,
                                   int                    y);
```

#### Parameters

| Parameter               | Description  |
|-------------------------|--|
| <a href="#">hObj</a>    | Handle of BUTTON widget.   |
| <a href="#">Index</a>   | See <i>BUTTON bitmap indexes</i> on page 1050 for a full list of permitted values. |
| <a href="#">pBitmap</a> | Pointer to a bitmap stream.  |
| <a href="#">x</a>       | X-position for the bitmap relative to the button.                                  |
| <a href="#">y</a>       | Y-position for the bitmap relative to the button.                                  |

#### Additional information

For details about streamed bitmaps, refer to *Drawing streamed bitmaps* on page 331.

### 6.2.5.5.1.37 BUTTON\_SetText()

#### Description

Sets the text to be displayed on the BUTTON widget.

#### Prototype

```
int BUTTON_SetText(      BUTTON_Handle  hObj,  
                    const char      * s);
```

#### Parameters

| Parameter         | Description              |
|-------------------|--------------------------|
| <code>hObj</code> | Handle of BUTTON widget. |
| <code>s</code>    | Text to display.         |

#### Return value

0        on success  
1        on error.

### 6.2.5.5.1.38 BUTTON\_SetTextAlign()

#### Description

Sets the text alignment of the BUTTON widget.

#### Prototype

```
void BUTTON_SetTextAlign(BUTTON_Handle hObj,  
                        int Align);
```

#### Parameters

| Parameter          | Description  |
|--------------------|--|
| <code>hObj</code>  | Handle of BUTTON widget.   |
| <code>Align</code> | Text alignment mode. List of flags can be found under <i>Text alignment flags</i> on page 252. |

#### Additional information

The default value of the text alignment is `GUI_TA_HCENTER` | `GUI_TA_VCENTER`.



### 6.2.5.5.1.39 BUTTON\_SetTextColor()

#### Description

Sets the text color of the BUTTON widget.

#### Prototype

```
void BUTTON_SetTextColor(BUTTON_Handle hObj,  
                        unsigned int  Index,  
                        GUI_COLOR     Color);
```

#### Parameters

| Parameter             | Description   |
|-----------------------|---|
| <a href="#">hObj</a>  | Handle of BUTTON widget.  |
| <a href="#">Index</a> | See <i>BUTTON color indexes</i> on page 1051 for a full list of permitted values. |
| <a href="#">Color</a> | Text color to be set.   |

#### 6.2.5.5.1.40 BUTTON\_SetTextOffset()

##### Description

Adjusts the position of the BUTTON text considering the current text alignment setting.

##### Prototype

```
void BUTTON_SetTextOffset(BUTTON_Handle hObj,  
                           int          xPos,  
                           int          yPos);
```

##### Parameters

| Parameter         | Description                                     |
|-------------------|---|
| <code>hObj</code> | Handle of BUTTON widget.                        |
| <code>xPos</code> | Offset to be used for the x-axis. Default is 0. |
| <code>yPos</code> | Offset to be used for the y-axis. Default is 0. |

### 6.2.5.5.1.41 BUTTON\_SetToggleMode()

#### Description

Enables toggle mode for the BUTTON widget. With this mode enabled, the BUTTON toggles between the pressed and unpressed state each time it is clicked.

#### Prototype

```
void BUTTON_SetToggleMode(BUTTON_Handle hObj,  
                           int          OnOff);
```

#### Parameters

| Parameter             | Description                                     |
|-----------------------|---|
| <a href="#">hObj</a>  | Handle of BUTTON widget.                        |
| <a href="#">OnOff</a> | 1 for enabling toggle mode, 0 for disabling it. |

#### 6.2.5.5.1.42 **BUTTON\_SetUserData()**

##### **Description**

Prototype explained at the beginning of the chapter as `<WIDGET>_SetUserData()` on page 995.

### 6.2.5.5.1.43 BUTTON\_Toggle()

#### Description

Toggles the state of the given BUTTON.

#### Prototype

```
int BUTTON_Toggle(BUTTON_Handle hObj);
```

#### Parameters

| Parameter         | Description              |
|-------------------|--------------------------|
| <code>hObj</code> | Handle of BUTTON widget. |

#### Return value

- 1 Error occurred.
- 0 If state was set to unpressed.
- 1 If state was set to pressed.

## 6.2.5.5.2 Defines

### 6.2.5.5.2.1 BUTTON bitmap indexes

#### Description

Bitmap indexes for BUTTON widget.

#### Definition

```
#define BUTTON_BI_UNPRESSED    0
#define BUTTON_BI_PRESSED      1
#define BUTTON_BI_DISABLED     2
```

#### Symbols

| Definition                          | Description                 |
|-------------------------------------|-----------------------------|
| <a href="#">BUTTON_BI_UNPRESSED</a> | Bitmap for disabled state.  |
| <a href="#">BUTTON_BI_PRESSED</a>   | Bitmap for pressed state.   |
| <a href="#">BUTTON_BI_DISABLED</a>  | Bitmap for unpressed state. |

### 6.2.5.5.2.2 BUTTON color indexes

#### Description

Color indexes for BUTTON widget.

#### Definition

```
#define BUTTON_CI_UNPRESSED    0
#define BUTTON_CI_PRESSED     1
#define BUTTON_CI_DISABLED    2
```

#### Symbols

| Definition                          | Description                |
|-------------------------------------|----------------------------|
| <a href="#">BUTTON_CI_UNPRESSED</a> | Color for disabled state.  |
| <a href="#">BUTTON_CI_PRESSED</a>   | Color for pressed state.   |
| <a href="#">BUTTON_CI_DISABLED</a>  | Color for unpressed state. |

### 6.2.5.6 Examples

The `Sample` folder contains the following examples which show how the widget can be used:

- `WIDGET_ButtonSimple.c`
- `WIDGET_ButtonPhone.c`
- `WIDGET_ButtonRound.c`

Note that several other examples also make use of this widget and may also be helpful to get familiar with the widget.

#### Screenshot of `WIDGET_ButtonSimple.c`:

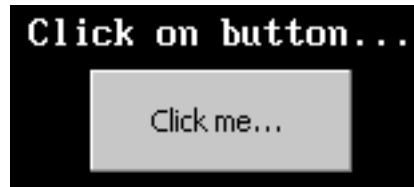

#### Screenshot of `WIDGET_ButtonPhone.c`:



#### Screenshot of `WIDGET_ButtonRound.c`:

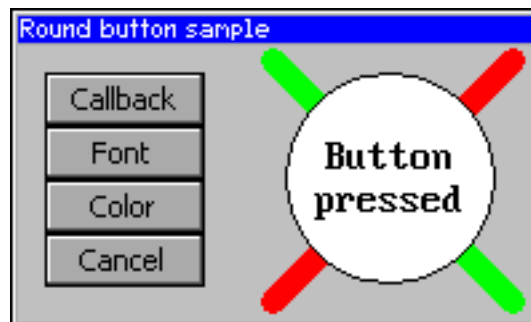



## 6.2.6 CHECKBOX: Checkbox widget

One of the most familiar widgets for selecting various choices is the check box. A check box may be checked or unchecked by the user, and any number of boxes may be checked at one time. If using a keyboard interface the state of a focused check box can be toggled by the <SPACE> key. A box will appear gray if it is disabled, as seen in the table below where each of the possible check box appearances are illustrated:

|          | Unchecked                       | Checked                                    | Third state                     |
|----------|---------------------------------|--|---------------------------------|
| Enabled  | <input type="checkbox"/> Item A | <input checked="" type="checkbox"/> Item B | <input type="checkbox"/> Item C |
| Disabled | <input type="checkbox"/> Item D | <input checked="" type="checkbox"/> Item E | <input type="checkbox"/> Item F |

### Note

All CHECKBOX-related routines are located in the file(s) CHECKBOX\*.c, CHECKBOX.h. All identifiers are prefixed CHECKBOX.

### Skinning...



...is available for this widget. The screenshot above shows the widget using the default skin. Details can be found in the chapter *Skinning* on page 2509.

### 6.2.6.1 Configuration options

| Type | Macro                       | Default                         | Description   |
|------|-----------------------------|---------------------------------|---|
| N    | CHECKBOX_BKCOLOR_DEFAULT    | 0xC0C0C0                        | Default background color.   |
| N    | CHECKBOX_BKCOLOR0_DEFAULT   | 0x808080                        | Background color of the default image, disabled state.                |
| N    | CHECKBOX_BKCOLOR1_DEFAULT   | GUI_WHITE                       | Background color of the default image, enabled state.                 |
| N    | CHECKBOX_FGCOLOR0_DEFAULT   | 0x101010                        | Foreground color of the default image, disabled state.                |
| N    | CHECKBOX_FGCOLOR1_DEFAULT   | GUI_BLACK                       | Foreground color of the default image, enabled state.                 |
| N    | CHECKBOX_FOCUSCOLOR_DEFAULT | GUI_BLACK                       | Color used to render the focus rectangle.                             |
| S    | CHECKBOX_FONT_DEFAULT       | &GUI_Font13_1                   | Default font used to display the optional CHECKBOX text.              |
| S    | CHECKBOX_IMAGE0_DEFAULT     | (see table above)               | Pointer to bitmap used to draw the widget if checked, disabled state. |
| S    | CHECKBOX_IMAGE1_DEFAULT     | (see table above)               | Pointer to bitmap used to draw the widget if checked, enabled state.  |
| N    | CHECKBOX_SPACING_DEFAULT    | 4                               | Spacing used to display the optional CHECKBOX text beside the box.    |
| N    | CHECKBOX_TEXTALIGN_DEFAULT  | GUI_TA_LEFT  <br>GUI_TA_VCENTER | Default alignment of the optional CHECKBOX text.                      |

| Type | Macro                      | Default   | Description   |
|------|----------------------------|-----------|---|
| N    | CHECKBOX_TEXTCOLOR_DEFAULT | GUI_BLACK | Default color used to display the optional CHECKBOX text. |

### 6.2.6.2 Predefined IDs

The following symbols define IDs which may be used to make CHECKBOX widgets distinguishable from creation.

```
#define GUI_ID_CHECK0    0x120
#define GUI_ID_CHECK1    0x121
#define GUI_ID_CHECK2    0x122
#define GUI_ID_CHECK3    0x123
#define GUI_ID_CHECK4    0x124
#define GUI_ID_CHECK5    0x125
#define GUI_ID_CHECK6    0x126
#define GUI_ID_CHECK7    0x127
#define GUI_ID_CHECK8    0x128
#define GUI_ID_CHECK9    0x129
```

### 6.2.6.3 Notification codes

The following events are sent from a check box widget to its parent window as part of a WM\_NOTIFY\_PARENT message:

| Message                       | Description  |
|-------------------------------|--|
| WM_NOTIFICATION_CLICKED       | CHECKBOX has been clicked.   |
| WM_NOTIFICATION_RELEASED      | CHECKBOX has been released.  |
| WM_NOTIFICATION_MOVED_OUT     | CHECKBOX has been clicked and pointer has been moved out of the box without releasing. |
| WM_NOTIFICATION_VALUE_CHANGED | Status of CHECKBOX has been changed.   |

### 6.2.6.4 Keyboard reaction

The widget reacts to the following keys if it has the input focus:

| Message       | Description                                       |
|---------------|---|
| GUI_KEY_SPACE | Toggles the checked state of the CHECKBOX widget. |

## 6.2.6.5 CHECKBOX API

The table below lists the available emWin CHECKBOX-related routines in alphabetical order. Detailed descriptions of the routines follow.

### Functions

| Routine                                     | Description  |
|---|--|
| <code>CHECKBOX_Check()</code>               | Set the state of CHECKBOX to checked. (Obsolete)   |
| <code>CHECKBOX_Create()</code>              | Creates a CHECKBOX widget. (Obsolete)  |
| <code>CHECKBOX_CreateEx()</code>            | Creates a CHECKBOX widget.   |
| <code>CHECKBOX_CreateIndirect()</code>      | Creates a CHECKBOX widget from resource table entry.   |
| <code>CHECKBOX_CreateUser()</code>          | Creates a CHECKBOX widget using extra bytes as user data.  |
| <code>CHECKBOX_GetBkColor()</code>          | Returns the currently set background color of the CHECKBOX widget.                                       |
| <code>CHECKBOX_GetBoxBkColor()</code>       | Returns the currently set background color used in the box of the CHECKBOX widget.                       |
| <code>CHECKBOX_GetDefaultAlign()</code>     | Returns the default text alignment used for CHECKBOX widgets.  |
| <code>CHECKBOX_GetDefaultBkColor()</code>   | Returns the default background color of new CHECKBOX widgets.  |
| <code>CHECKBOX_GetDefaultFont()</code>      | Returns a pointer to a <code>GUI_FONT</code> structure used to display the text of new CHECKBOX widgets. |
| <code>CHECKBOX_GetDefaultSpacing()</code>   | Returns the default spacing between box and text used to display the text of new CHECKBOX widgets.       |
| <code>CHECKBOX_GetDefaultTextAlign()</code> | Returns the default alignment used to display the text of CHECKBOX widgets.                              |
| <code>CHECKBOX_GetDefaultTextColor()</code> | Returns the default text color used to display the text of new CHECKBOX widgets.                         |
| <code>CHECKBOX_GetFocusColor()</code>       | This function returns the color currently used as focus color.   |
| <code>CHECKBOX_GetFont()</code>             | Returns the currently set font.  |
| <code>CHECKBOX_GetImage()</code>            | Returns the image set for the given index.   |
| <code>CHECKBOX_GetState()</code>            | Returns the current state of the given CHECKBOX widget.  |
| <code>CHECKBOX_GetText()</code>             | Returns the optional text of the given CHECKBOX widget.  |
| <code>CHECKBOX_GetTextAlign()</code>        | This function returns the text alignment of the given TEXT widget.                                       |
| <code>CHECKBOX_GetTextColor()</code>        | This function returns the color currently used the text.   |
| <code>CHECKBOX_GetUserData()</code>         | Retrieves the data set with <code>CHECKBOX_SetUserData()</code> .  |
| <code>CHECKBOX_IsChecked()</code>           | Returns the current state (checked or not checked) of a specified CHECKBOX widget.                       |
| <code>CHECKBOX_SetBkColor()</code>          | Sets the background color used to display the background of the CHECKBOX widget.                         |

| Routine                                      | Description   |
|--|---|
| <code>CHECKBOX_SetBoxBkColor()</code>        | Sets the background color of the box area. (Obsolete)   |
| <code>CHECKBOX_SetDefaultAlign()</code>      | Sets the default text alignment used for new CHECKBOX widgets.  |
| <code>CHECKBOX_SetDefaultBkColor()</code>    | Sets the default background color used for new CHECKBOX widgets.                                      |
| <code>CHECKBOX_SetDefaultFocusColor()</code> | Sets the color used to render the focus rectangle of new CHECKBOX widgets.                            |
| <code>CHECKBOX_SetDefaultFont()</code>       | Sets a pointer to a <code>GUI_FONT</code> structure used to display the text of new CHECKBOX widgets. |
| <code>CHECKBOX_SetDefaultImage()</code>      | Sets the default image to be shown when a box has been checked.                                       |
| <code>CHECKBOX_SetDefaultSpacing()</code>    | Sets the default spacing between box and text used to display the text of new CHECKBOX widgets.       |
| <code>CHECKBOX_SetDefaultTextAlign()</code>  | Sets the default alignment used to display the text of CHECKBOX widgets.                              |
| <code>CHECKBOX_SetDefaultTextColor()</code>  | Sets the default text color used to display the text of new CHECKBOX widgets.                         |
| <code>CHECKBOX_SetFocusColor()</code>        | Sets the color of the focus rectangle.  |
| <code>CHECKBOX_SetFont()</code>              | Sets the font of the CHECKBOX widget.   |
| <code>CHECKBOX_SetImage()</code>             | Sets the image to be shown when CHECKBOX widget been checked.   |
| <code>CHECKBOX_SetNumStates()</code>         | Sets the number of possible states of the CHECKBOX widget (2 or 3).                                   |
| <code>CHECKBOX_SetSpacing()</code>           | Sets the spacing between the box and the check box text.  |
| <code>CHECKBOX_SetState()</code>             | Sets the state of the CHECKBOX widget.  |
| <code>CHECKBOX_SetText()</code>              | Sets the text of the CHECKBOX widget.   |
| <code>CHECKBOX_SetTextAlign()</code>         | Sets the alignment used to display the text of the CHECKBOX widget.                                   |
| <code>CHECKBOX_SetTextColor()</code>         | Sets the color used to display the text of the CHECKBOX widget.                                       |
| <code>CHECKBOX_SetUserData()</code>          | Sets the extra data of a CHECKBOX widget.   |
| <code>CHECKBOX_Uncheck()</code>              | Set the state of CHECKBOX to unchecked. (Obsolete)  |

## Defines

| Group of defines                     | Description                         |
|--------------------------------------|-------------------------------------|
| <code>CHECKBOX_bitmap_indexes</code> | Bitmap indexes for CHECKBOX widget. |
| <code>CHECKBOX_color_indexes</code>  | Color indexes for CHECKBOX widget.  |

## 6.2.6.5.1 Functions

### 6.2.6.5.1.1 CHECKBOX\_Check()

#### Note

This function is **deprecated**, `CHECKBOX_SetState()` should be used instead.

| Before                          | After                                      |
|---------------------------------|--|
| <input type="checkbox"/> Item 1 | <input checked="" type="checkbox"/> Item 1 |

#### Description

Sets the state of a specified CHECKBOX widget to checked.

#### Prototype

```
void CHECKBOX_Check(CHECKBOX_Handle hObj);
```

#### Parameters

| Parameter            | Description                |
|----------------------|----------------------------|
| <a href="#">hObj</a> | Handle of CHECKBOX widget. |

### 6.2.6.5.1.2 CHECKBOX\_Create()

#### Note

This function is **deprecated**, CHECKBOX\_CreateEx() should be used instead.

#### Description

Creates a CHECKBOX widget of a specified size at a specified location.

#### Prototype

```
CHECKBOX_Handle CHECKBOX_Create(int    x0,
                                int    y0,
                                int    xSize,
                                int    ySize,
                                WM_HWIN hParent,
                                int    Id,
                                int    Flags);
```

#### Parameters

| Parameter            | Description  |
|----------------------|--|
| <code>x0</code>      | Leftmost pixel of the check box (in parent coordinates).   |
| <code>y0</code>      | Topmost pixel of the check box (in parent coordinates).  |
| <code>xSize</code>   | Horizontal size of the check box (in pixels).  |
| <code>ySize</code>   | Vertical size of the check box (in pixels).  |
| <code>hParent</code> | Handle of parent window.   |
| <code>Id</code>      | ID to be returned.   |
| <code>Flags</code>   | Window create flags. Typically <code>WM_CF_SHOW</code> in order to make the widget visible immediately (refer to <i>Window create flags</i> on page 977 for a list of available parameter values). |

#### Return value

Handle of the created CHECKBOX widget; 0 if the function fails.

#### Additional information

If the parameters `xSize` or `ySize` are 0 the size of the bitmap will be used as default size of the check box.

### 6.2.6.5.1.3 CHECKBOX\_CreateEx()

#### Description

Creates a CHECKBOX widget of a specified size at a specified location.

#### Prototype

```
CHECKBOX_Handle CHECKBOX_CreateEx(int    x0,
                                   int    y0,
                                   int    xSize,
                                   int    ySize,
                                   WM_HWIN hParent,
                                   int    WinFlags,
                                   int    ExFlags,
                                   int    Id);
```

#### Parameters

| Parameter             | Description  |
|-----------------------|--|
| <code>x0</code>       | Leftmost pixel of the check box (in parent coordinates).   |
| <code>y0</code>       | Topmost pixel of the check box (in parent coordinates).  |
| <code>xSize</code>    | Horizontal size of the check box (in pixels).  |
| <code>ySize</code>    | Vertical size of the check box (in pixels).  |
| <code>hParent</code>  | Handle of parent window.   |
| <code>WinFlags</code> | Window create flags. Typically <code>WM_CF_SHOW</code> in order to make the widget visible immediately (refer to <i>Window create flags</i> on page 977 for a list of available parameter values). |
| <code>ExFlags</code>  | Not used yet, reserved for future use.   |
| <code>Id</code>       | ID to be returned.   |

#### Return value

Handle of the created CHECKBOX widget; 0 if the function fails.

#### Additional information

If the parameters `xSize` or `ySize` are 0 the size of the default check mark bitmap (11 \* 11 pixels) plus the effect size will be used as default size of the check box. If the desired size of the check box is different to the default size it can be useful to set a user defined check mark image using the function `CHECKBOX_SetImage()`.

If check box text should be shown with the widget the size should be large enough to show the box + text + spacing between box and text.

#### 6.2.6.5.1.4 CHECKBOX\_CreateIndirect()

##### Description

The prototype of this function is explained at the beginning of this chapter. Details can be found in the description of the function `<WIDGET>_CreateIndirect()` on page 992. The elements `Flags` and `Para` of the according `GUI_WIDGET_CREATE_INFO` structure are not used.



### 6.2.6.5.1.5 CHECKBOX\_CreateUser()

#### Description

Prototype explained at the beginning of the chapter as `<WIDGET>_CreateUser()` on page 993. For a detailed description of the parameters the function `CHECKBOX_CreateEx()` can be referred to.

### 6.2.6.5.1.6 CHECKBOX\_GetBkColor()

#### Description

Returns the currently set background color of the CHECKBOX widget.

#### Prototype

```
GUI_COLOR CHECKBOX_GetBkColor(CHECKBOX_Handle hObj);
```

#### Parameters

| Parameter            | Description                |
|----------------------|----------------------------|
| <a href="#">hObj</a> | Handle of CHECKBOX widget. |

#### Return value

The color currently used as background color.

### 6.2.6.5.1.7 CHECKBOX\_GetBoxBkColor()

#### Description

Returns the currently set background color used in the box of the CHECKBOX widget.

#### Prototype

```
GUI_COLOR CHECKBOX_GetBoxBkColor(CHECKBOX_Handle hObj,  
                                int Index);
```

#### Parameters

| Parameter             | Description  |
|-----------------------|--|
| <a href="#">hObj</a>  | Handle of CHECKBOX widget.   |
| <a href="#">Index</a> | See <i>Checkbox color indexes</i> on page for a full list of permitted values. |

#### Return value

Background color used for the corresponding state.

### 6.2.6.5.1.8 CHECKBOX\_GetDefaultAlign()

#### Description

Returns the default text alignment used for CHECKBOX widgets.

#### Prototype

```
int CHECKBOX_GetDefaultAlign(void);
```

#### Return value

Default text alignment. Refer to *Text alignment flags* on page 252 a list of permitted values.

### 6.2.6.5.1.9 CHECKBOX\_GetDefaultBkColor()

#### Description

Returns the default background color of new CHECKBOX widgets.

#### Prototype

```
GUI_COLOR CHECKBOX_GetDefaultBkColor(void);
```

#### Return value

Default background color of new CHECKBOX widgets.

#### Additional information

The background color returned by this function is not the background color shown in the box, but the background color of the rest of the widget.

For more information, refer to `CHECKBOX_SetBoxBkColor()`.

### 6.2.6.5.1.10 CHECKBOX\_GetDefaultFont()

#### Description

Returns a pointer to a `GUI_FONT` structure used to display the text of new `CHECKBOX` widgets.

#### Prototype

```
GUI_FONT *CHECKBOX_GetDefaultFont(void);
```

#### Return value

Pointer to a `GUI_FONT` structure used to display the text of new `CHECKBOX` widgets.

#### Additional information

For more information, refer to `CHECKBOX_SetFont()`.

### 6.2.6.5.1.11 CHECKBOX\_GetDefaultSpacing()

#### Description

Returns the default spacing between box and text used to display the text of new CHECKBOX widgets.

#### Prototype

```
int CHECKBOX_GetDefaultSpacing(void);
```

#### Return value

Default spacing between box and text used to display the text of new CHECKBOX widgets.

#### Additional information

For more information, refer to CHECKBOX\_SetSpacing().

### 6.2.6.5.1.12 CHECKBOX\_GetDefaultTextAlign()

#### Description

Returns the default alignment used to display the text of new CHECKBOX widgets.

#### Prototype

```
int CHECKBOX_GetDefaultAlign(void);
```

#### Return value

Default alignment used to display the text of new CHECKBOX widgets.

#### Additional information

For more information, refer to *CHECKBOX\_SetTextAlign()* on page 1096.



### 6.2.6.5.1.13 CHECKBOX\_GetDefaultTextColor()

#### Description

Returns the default text color used to display the text of new CHECKBOX widgets.

#### Prototype

```
GUI_COLOR CHECKBOX_GetDefaultTextColor(void);
```

#### Return value

Default text color used to display the text of new check box widgets.

#### Additional information

For more information, refer to `CHECKBOX_SetTextColor()`.

#### 6.2.6.5.1.14 CHECKBOX\_GetFocusColor()

##### Description

This function returns the color currently used as focus color.

##### Prototype

```
GUI_COLOR CHECKBOX_GetFocusColor(CHECKBOX_Handle hObj);
```

##### Parameters

| Parameter            | Description                |
|----------------------|----------------------------|
| <a href="#">hObj</a> | Handle of CHECKBOX widget. |

##### Return value

The color currently used to draw the focus.

### 6.2.6.5.1.15 CHECKBOX\_GetFont()

#### Description

Returns the currently set font.

#### Prototype

```
GUI_FONT *CHECKBOX_GetFont(CHECKBOX_Handle hObj);
```

#### Parameters

| Parameter            | Description                |
|----------------------|----------------------------|
| <a href="#">hObj</a> | Handle of CHECKBOX widget. |

#### Return value

A pointer the font which is used for the CHECKBOX.

### 6.2.6.5.1.16 CHECKBOX\_GetImage()

#### Description

Returns the image set for the given index.

#### Prototype

```
GUI_BITMAP *CHECKBOX_GetImage(CHECKBOX_Handle hObj,  
                               unsigned int   Index);
```

#### Parameters

| Parameter             | Description  |
|-----------------------|--|
| <a href="#">hObj</a>  | Handle of CHECKBOX widget.   |
| <a href="#">Index</a> | See <i>Checkbox bitmap indexes</i> on page <a href="#">1073</a> for a full list of permitted values. |

#### Return value

A pointer the image used with the given index.

### 6.2.6.5.1.17 CHECKBOX\_GetState()

#### Description

Returns the current state of the given CHECKBOX widget.

#### Prototype

```
int CHECKBOX_GetState(CHECKBOX_Handle hObj);
```

#### Parameters

| Parameter            | Description                |
|----------------------|----------------------------|
| <a href="#">hObj</a> | Handle of CHECKBOX widget. |

#### Return value

Current state of the given CHECKBOX widget.

#### Additional information

Per default a check box can have 2 states, checked (1) and unchecked (0). With the function `CHECKBOX_SetNumStates()` the number of possible states can be increased to 3. If the check box is in the third state the function returns 2.

For more information, refer to `CHECKBOX_SetNumStates()`.

### 6.2.6.5.1.18 CHECKBOX\_GetText()

#### Description

Returns the optional text of the given CHECKBOX widget.

#### Prototype

```
int CHECKBOX_GetText(CHECKBOX_Handle hObj,  
                    char * pBuffer,  
                    int MaxLen);
```

#### Parameters

| Parameter            | Description   |
|----------------------|---|
| <code>hObj</code>    | Handle of CHECKBOX widget.                          |
| <code>pBuffer</code> | Pointer to buffer to which the text will be copied. |
| <code>MaxLen</code>  | Buffer size in bytes.                               |

#### Return value

Length of the text copied into the buffer.

#### Additional information

If the CHECKBOX widget contains no text the function returns 0 and the buffer remains unchanged.

### 6.2.6.5.1.19 CHECKBOX\_GetTextAlign()

#### Description

This function returns the text alignment of the given TEXT widget.

#### Prototype

```
int CHECKBOX_GetTextAlign(CHECKBOX_Handle hObj);
```

#### Parameters

| Parameter            | Description                |
|----------------------|----------------------------|
| <a href="#">hObj</a> | Handle of CHECKBOX widget. |

#### Return value

Returns the currently used text alignment.

### 6.2.6.5.1.20 CHECKBOX\_GetTextColor()

#### Description

This function returns the color currently used the text.

#### Prototype

```
GUI_COLOR CHECKBOX_GetTextColor(CHECKBOX_Handle hObj);
```

#### Parameters

| Parameter            | Description                |
|----------------------|----------------------------|
| <a href="#">hObj</a> | Handle of CHECKBOX widget. |

#### Return value

The color currently used displaying the text.



### 6.2.6.5.1.21 CHECKBOX\_GetUserData()

#### Description

Prototype explained at the beginning of the chapter as `<WIDGET>_GetUserData()` on page 994.

### 6.2.6.5.1.22 CHECKBOX\_IsChecked()

#### Description

Returns the current state (checked or not checked) of a specified CHECKBOX widget.

#### Prototype

```
int CHECKBOX_IsChecked(CHECKBOX_Handle hObj);
```

#### Parameters

| Parameter            | Description                |
|----------------------|----------------------------|
| <a href="#">hObj</a> | Handle of CHECKBOX widget. |

#### Return value

|   |             |
|---|-------------|
| 0 | not checked |
| 1 | checked     |

### 6.2.6.5.1.23 CHECKBOX\_SetBkColor()

| Before                          | After                           |
|---------------------------------|---------------------------------|
| <input type="checkbox"/> Item 1 | <input type="checkbox"/> Item 1 |

#### Description

Sets the background color used to display the background of the CHECKBOX widget.

#### Prototype

```
void CHECKBOX_SetBkColor(CHECKBOX_Handle hObj,
                        GUI_COLOR      Color);
```

#### Parameters

| Parameter          | Description   |
|--------------------|---|
| <code>hObj</code>  | Handle of CHECKBOX widget.  |
| <code>Color</code> | <code>Color</code> to be used to draw the background or <code>GUI_INVALID_COLOR</code> to work in transparent mode. |



#### Additional information

If the check box should work in transparent mode `GUI_INVALID_COLOR` should be used.

### 6.2.6.5.1.24 CHECKBOX\_SetBoxBkColor()

#### Note

This function is **deprecated** and only works in conjunction with the classic skin (`CHECKBOX_SetSkinClassic()`). Skinning props should be used instead which can be set via `CHECKBOX_SetSkinFlexProps()`.

| Before   | After  |
|--|--|
|  Item 1 |  Item 1 |

#### Description

Sets the background color of the box area.

#### Prototype

```
GUI_COLOR CHECKBOX_SetBoxBkColor(CHECKBOX_Handle hObj,
                                GUI_COLOR      Color,
                                int              Index);
```

#### Parameters

| Parameter          | Description   |
|--------------------|---|
| <code>hObj</code>  | Handle of CHECKBOX widget.  |
| <code>Color</code> | <code>Color</code> to be used.  |
| <code>Index</code> | See <i>Checkbox color indexes</i> on page <a href="#">1080</a> for a full list of permitted values. |

#### Return value

Previous background color.

#### Additional information

The color set by this function will only be visible, if the images used by the widget are transparent or no image is used. The default images of this widget are transparent.

### 6.2.6.5.1.25 CHECKBOX\_SetDefaultAlign()

#### Description

Sets the default text alignment used for new CHECKBOX widgets.

#### Prototype

```
void CHECKBOX_SetDefaultAlign(int Align);
```

#### Parameters

| Parameter             | Description  |
|-----------------------|--|
| <a href="#">Align</a> | Text alignment flags. See <i>Text alignment flags</i> on page 252 for a full list of permitted values. |

### 6.2.6.5.1.26 CHECKBOX\_SetDefaultBkColor()

#### Description

Sets the default background color used for new CHECKBOX widgets.

#### Prototype

```
void CHECKBOX_SetDefaultBkColor(GUI_COLOR Color);
```

#### Parameters

| Parameter | Description   |
|-----------|---|
| Color     | Color to be used, GUI_INVALID_COLOR for transparency. |

#### Additional information

For more information, refer to CHECKBOX\_SetBkColor.

### 6.2.6.5.1.27 CHECKBOX\_SetDefaultFocusColor()

#### Description

Sets the color used to render the focus rectangle of new CHECKBOX widgets.

#### Prototype

```
GUI_COLOR CHECKBOX_SetDefaultFocusColor(GUI_COLOR Color);
```

#### Parameters

| Parameter | Description       |
|-----------|-------------------|
| Color     | Color to be used. |

#### Return value

Previous color used to render the focus rectangle.

#### Additional information

For more information, refer to `CHECKBOX_SetFocusColor()`.

### 6.2.6.5.1.28 CHECKBOX\_SetDefaultFont()

#### Description

Sets a pointer to a GUI\_FONT structure used to display the text of new CHECKBOX widgets.

#### Prototype

```
void CHECKBOX_SetDefaultFont(const GUI_FONT * pFont);
```

#### Parameters

| Parameter          | Description                               |
|--------------------|---|
| <code>pFont</code> | Pointer to GUI_FONT structure to be used. |

#### Additional information

For mode information, refer to CHECKBOX\_SetFont().



### 6.2.6.5.1.29 CHECKBOX\_SetDefaultImage()

#### Description

Sets the images used for new CHECKBOX widgets to be shown if they has been checked.

#### Prototype

```
void CHECKBOX_SetDefaultImage(const GUI_BITMAP * pBitmap,
                             unsigned int   Index);
```

#### Parameters

| Parameter            | Description  |
|----------------------|--|
| <code>pBitmap</code> | Pointer to bitmap.   |
| <code>Index</code>   | See <i>Checkbox bitmap indexes</i> on page      for a full list of permitted values. |

#### Additional information

The image has to fill the complete inner area of the CHECKBOX widget.

### 6.2.6.5.1.30 CHECKBOX\_SetDefaultSpacing()

#### Description

Sets the default spacing between box and text used to display the text of new CHECKBOX widgets.

#### Prototype

```
void CHECKBOX_SetDefaultSpacing(int Spacing);
```

#### Parameters

| Parameter            | Description  |
|----------------------|--|
| <code>Spacing</code> | Number of pixels between box and text used for new CHECKBOX widgets. |

#### Additional information

For more information, refer to `CHECKBOX_SetSpacing()`.

### 6.2.6.5.1.31 CHECKBOX\_SetDefaultTextAlign()

#### Description

Sets the default alignment used to display the text of new CHECKBOX widgets.

#### Prototype

```
void CHECKBOX_SetDefaultTextAlign(int Align);
```

| Parameter          | Description  |
|--------------------|--|
| <code>Align</code> | Text alignment mode. List of flags can be found under <i>Text alignment flags</i> on page 252. |

#### Additional information

For more information, refer to *CHECKBOX\_SetTextAlign()* on page 1096.

### 6.2.6.5.1.32 CHECKBOX\_SetDefaultTextColor()

#### Description

Sets the default text color used to display the text of new CHECKBOX widgets.

#### Prototype

```
void CHECKBOX_SetDefaultTextColor(GUI_COLOR Color);
```



#### Parameters

| Parameter | Description       |
|-----------|-------------------|
| Color     | Color to be used. |

#### Additional information

For more information, refer to CHECKBOX\_SetTextColor().

### 6.2.6.5.1.33 CHECKBOX\_SetFocusColor()

| Before  | After   |
|---|---|
|  |  |

#### Description

Sets the color used to render the focus rectangle.

#### Prototype

```
GUI_COLOR CHECKBOX_SetFocusColor(CHECKBOX_Handle hObj,
                                  GUI_COLOR      Color);
```

#### Parameters

| Parameter          | Description                    |
|--------------------|--------------------------------|
| <code>hObj</code>  | Handle of CHECKBOX widget.     |
| <code>Color</code> | <code>Color</code> to be used. |

#### Return value

Previous color of the focus rectangle.

#### Additional information

The focus rectangle is only visible if the widget has the input focus.

### 6.2.6.5.1.34 CHECKBOX\_SetFont()

#### Description

Sets the font of the CHECKBOX widget.





#### Prototype

```
void CHECKBOX_SetFont(      CHECKBOX_Handle  hObj,  
                          const GUI_FONT    * pFont);
```

#### Parameters

| Parameter          | Description                |
|--------------------|----------------------------|
| <code>hObj</code>  | Handle of CHECKBOX widget. |
| <code>pFont</code> | Pointer to the font.       |

### 6.2.6.5.1.35 CHECKBOX\_SetImage()

| Before   | After  |
|--|--|
|  Item 1 |  Item 1 |
|  Item 1 |  Item 1 |

#### Description

Sets the images to be shown if the CHECKBOX widget has been checked.

#### Prototype

```
void CHECKBOX_SetImage(    CHECKBOX_Handle  hObj,
                          const GUI_BITMAP    * pBitmap,
                          unsigned int       Index);
```

#### Parameters

| Parameter            | Description  |
|----------------------|--|
| <code>hObj</code>    | Handle of CHECKBOX widget.   |
| <code>pBitmap</code> | Pointer to bitmap.   |
| <code>Index</code>   | See <i>Checkbox bitmap indexes</i> on page <a href="#">1091</a> for a full list of permitted values. |

#### Additional information

The image has to fill the complete inner area of the check box. If using this function make sure, the size of the check box used to create the widget is large enough to show the bitmap and (optional) the text.

### 6.2.6.5.1.36 CHECKBOX\_SetNumStates()

#### Description

This function sets the number of possible states of the given CHECKBOX widget.

#### Prototype

```
void CHECKBOX_SetNumStates(CHECKBOX_Handle hObj,  
                           unsigned NumStates);
```

#### Parameters

| Parameter              | Description  |
|------------------------|--|
| <code>hObj</code>      | Handle of CHECKBOX widget.   |
| <code>NumStates</code> | Number of possible states of the given check box. Currently supported are 2 or 3 states. |

#### Additional information

Per default a check box supports 2 states: checked (1) and unchecked (0). If the check box should support a third state the number of possible states can be increased to 3.



### 6.2.6.5.1.37 CHECKBOX\_SetSpacing()

| Before                          | After                           |
|---------------------------------|---------------------------------|
| <input type="checkbox"/> Item 1 | <input type="checkbox"/> Item 1 |

#### Description

Sets the number of pixels between box and text of a given CHECKBOX widget.

#### Prototype

```
void CHECKBOX_SetSpacing(CHECKBOX_Handle hObj,
                        unsigned Spacing);
```

#### Parameters

| Parameter            | Description                                       |
|----------------------|---|
| <code>hObj</code>    | Handle of CHECKBOX widget.                        |
| <code>Spacing</code> | Number of pixels between box and text to be used. |

#### Additional information

The default spacing is 4 pixels. The function `CHECKBOX_SetDefaultSpacing()` or the configuration macro `CHECKBOX_SPACING_DEFAULT` can be used to set the default value.

### 6.2.6.5.1.38 CHECKBOX\_SetState()

| Before                          | After  |
|---------------------------------|--|
| <input type="checkbox"/> Item 1 | <input checked="" type="checkbox"/> Item 1<br><input checked="" type="checkbox"/> Item 1 |

#### Description

Sets the new state of the given CHECKBOX widget.

#### Prototype

```
void CHECKBOX_SetState(CHECKBOX_Handle hObj,
                      unsigned State);
```

#### Parameters

| Parameter          | Description                     |
|--------------------|---------------------------------|
| <code>hObj</code>  | Handle of CHECKBOX widget.      |
| <code>State</code> | Zero-based number of new state. |

| Permitted values for parameter <code>State</code> |             |
|---|-------------|
| 0   | Unchecked   |
| 1   | Checked     |
| 2   | Third state |

#### Additional information

The passed state should not be greater than the number of possible states set with `CHECKBOX_SetNumStates()` minus 1.

### 6.2.6.5.1.39 CHECKBOX\_SetText()

| Before   | After                           |
|--|---------------------------------|
| <input type="checkbox"/>  | <input type="checkbox"/> Item 1 |

#### Description

Sets the optional text shown beside the box.

#### Prototype

```
void CHECKBOX_SetText(    CHECKBOX_Handle  hObj,
                        const char      * s);
```

#### Parameters

| Parameter | Description                                 |
|-----------|---|
| hObj      | Handle of CHECKBOX widget.                  |
| s         | Pointer to text to be shown beside the box. |

#### Additional information

Clicking on the text beside the box has the same effect as clicking into the box.

### 6.2.6.5.1.40 CHECKBOX\_SetTextAlign()

| Before                                     | After                                      |
|--|--|
| <input checked="" type="checkbox"/> Item 1 | <input checked="" type="checkbox"/> Item 1 |

#### Description

Sets the alignment used to display the text beside the box.

#### Prototype

```
void CHECKBOX_SetTextAlign(CHECKBOX_Handle hObj,
                           int Align);
```

#### Parameters

| Parameter          | Description  |
|--------------------|--|
| <code>hObj</code>  | Handle of CHECKBOX widget.   |
| <code>Align</code> | Text alignment mode. List of flags can be found under <i>Text alignment flags</i> on page 252. |

#### Additional information

Per default the text alignment is `GUI_TA_LEFT | GUI_TA_VCENTER`. The function `CHECKBOX_SetDefaultTextAlign()` and the configuration macro `CHECKBOX_TEXTALIGN_DEFAULT` can be used to set a user defined default value.

### 6.2.6.5.1.41 CHECKBOX\_SetTextColor()

| Before                                     | After                                      |
|--|--|
| <input checked="" type="checkbox"/> Item 1 | <input checked="" type="checkbox"/> Item 1 |

#### Description

Sets the color used to display the text of the CHECKBOX widget.

#### Prototype

```
void CHECKBOX_SetTextColor(CHECKBOX_Handle hObj,
                          GUI_COLOR      Color);
```

#### Parameters

| Parameter          | Description                      |
|--------------------|----------------------------------|
| <code>hObj</code>  | Handle of CHECKBOX widget.       |
| <code>Color</code> | Desired color of check box text. |

#### Additional information

Per default the text color of a check box text is `GUI_BLACK`. The function `CHECKBOX_SetDefaultTextColor()` and the configuration macro `CHECKBOX_TEXTCOLOR_DEFAULT` can be used to set a user defined default color.

#### 6.2.6.5.1.42 CHECKBOX\_SetUserData()

##### Description

Prototype explained at the beginning of the chapter as `<WIDGET>_SetUserData()` on page 995.

### 6.2.6.5.1.43 CHECKBOX\_Uncheck()

#### Note

This function is **deprecated**, `CHECKBOX_SetState()` should be used instead.

| Before                                     | After                           |
|--|---------------------------------|
| <input checked="" type="checkbox"/> Item 1 | <input type="checkbox"/> Item 1 |

#### Description

Sets the state of a specified CHECKBOX widget to unchecked.

#### Prototype

```
void CHECKBOX_Uncheck(CHECKBOX_Handle hObj);
```

| Parameter         | Description                |
|-------------------|----------------------------|
| <code>hObj</code> | Handle of CHECKBOX widget. |

#### Additional information

This is the default setting for CHECKBOX widgets.

## 6.2.6.5.2 Defines

### 6.2.6.5.2.1 CHECKBOX bitmap indexes

#### Description

Bitmap indexes for CHECKBOX widget.

#### Definition

```
#define CHECKBOX_BI_INACTIV_UNCHECKED 0
#define CHECKBOX_BI_ACTIV_UNCHECKED 1
#define CHECKBOX_BI_INACTIV_CHECKED 2
#define CHECKBOX_BI_ACTIV_CHECKED 3
#define CHECKBOX_BI_INACTIV_3STATE 4
#define CHECKBOX_BI_ACTIV_3STATE 5
```

#### Symbols

| Definition                    | Description  |
|-------------------------------|--|
| CHECKBOX_BI_INACTIV_UNCHECKED | Bitmap displayed when the CHECKBOX is unchecked and disabled.          |
| CHECKBOX_BI_ACTIV_UNCHECKED   | Bitmap displayed when the CHECKBOX is unchecked and enabled.           |
| CHECKBOX_BI_INACTIV_CHECKED   | Bitmap displayed when the CHECKBOX is checked and disabled.            |
| CHECKBOX_BI_ACTIV_CHECKED     | Bitmap displayed when the CHECKBOX is checked and enabled.             |
| CHECKBOX_BI_INACTIV_3STATE    | Bitmap displayed when the CHECKBOX is in the third state and disabled. |
| CHECKBOX_BI_ACTIV_3STATE      | Bitmap displayed when the CHECKBOX is in the third state and enabled.  |



### 6.2.6.5.2.2 CHECKBOX color indexes

#### Description

Color indexes for CHECKBOX widget.

#### Definition

```
#define CHECKBOX_CI_DISABLED    0
#define CHECKBOX_CI_ENABLED    1
```

#### Symbols

| Definition                           | Description                    |
|--------------------------------------|--------------------------------|
| <a href="#">CHECKBOX_CI_DISABLED</a> | Color used for disabled state. |
| <a href="#">CHECKBOX_CI_ENABLED</a>  | Color used for enabled state.  |

### 6.2.6.6 Example

The `Sample` folder contains the following example which shows how the widget can be used:

- `WIDGET_Checkbox.c`

Note that several other examples also make use of this widget and may also be helpful to get familiar with the widget.

#### Screenshot of `WIDGET_Checkbox.c`:

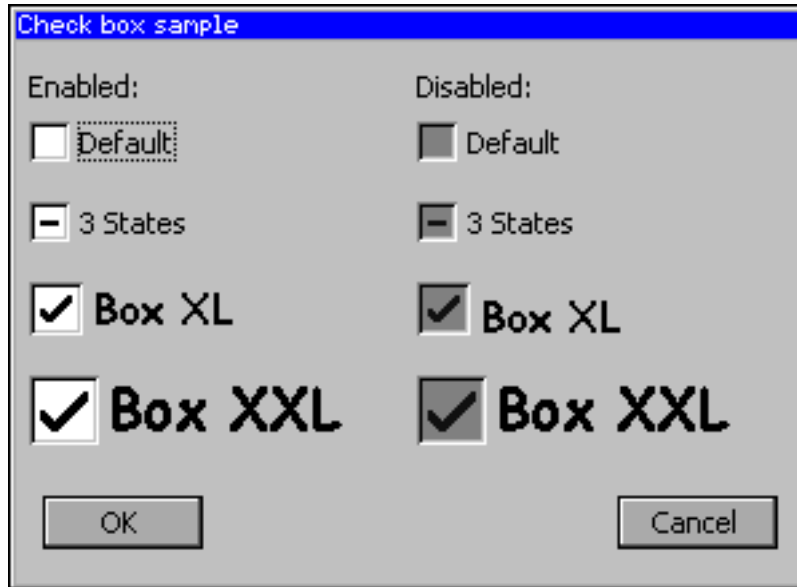

## 6.2.7 DROPDOWN: Dropdown widget

DROPDOWN widgets are used to select one element of a list with several columns. It shows the currently selected item in non open state. If the user opens a DROPDOWN widget a LISTBOX appears to select a new item.

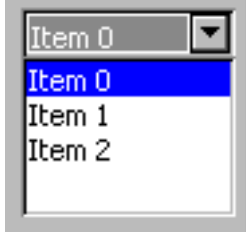
| DROPDOWN closed   | DROPDOWN opened  |
|---|--|
|  |  |

### Note

All DROPDOWN-related routines are located in the file(s) `DROPDOWN*.c`, `DROPDOWN.h`. All identifiers are prefixed `DROPDOWN`.

If mouse support is enabled, the open list reacts on moving the mouse over it.

### Skinning...

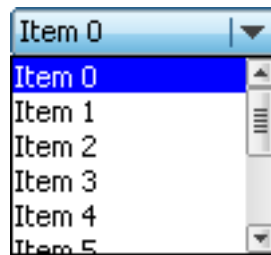

...is available for this widget. The screenshot above shows the widget using the default skin. Details can be found in the chapter *Skinning* on page 2509.

### 6.2.7.1 Configuration options

| Type | Macro                                    | Default                        | Description  |
|------|--|--------------------------------|--|
| N    | <code>DROPDOWN_ALIGN_DEFAULT</code>      | <code>GUI_TA_LEFT</code>       | Text alignment used to display the dropdown text in closed state.    |
| S    | <code>DROPDOWN_FONT_DEFAULT</code>       | <code>&amp;GUI_Font13_1</code> | Default font.  |
| N    | <code>DROPDOWN_BKCOLOR0_DEFAULT</code>   | <code>GUI_WHITE</code>         | Background color, unselected state.                                  |
| N    | <code>DROPDOWN_BKCOLOR1_DEFAULT</code>   | <code>GUI_GRAY</code>          | Background color, selected state without focus.                      |
| N    | <code>DROPDOWN_BKCOLOR2_DEFAULT</code>   | <code>GUI_BLUE</code>          | Background color, selected state with focus.                         |
| N    | <code>DROPDOWN_KEY_EXPAND</code>         | <code>GUI_KEY_SPACE</code>     | Key which can be used to expand the DROPDOWN list.                   |
| N    | <code>DROPDOWN_KEY_SELECT</code>         | <code>GUI_KEY_ENTER</code>     | Key which can be used to select an item from the open dropdown list. |
| N    | <code>DROPDOWN_TEXTCOLOR0_DEFAULT</code> | <code>GUI_BLACK</code>         | Text color, unselected state.  |
| N    | <code>DROPDOWN_TEXTCOLOR1_DEFAULT</code> | <code>GUI_BLACK</code>         | Text color, selected state without focus.                            |
| N    | <code>DROPDOWN_TEXTCOLOR2_DEFAULT</code> | <code>GUI_WHITE</code>         | Enable 3D support.   |

### 6.2.7.2 Predefined IDs

The following symbols define IDs which may be used to make DROPDOWN widgets distinguishable from creation.

```
#define GUI_ID_DROPDOWN0    0x180
#define GUI_ID_DROPDOWN1    0x181
#define GUI_ID_DROPDOWN2    0x182
#define GUI_ID_DROPDOWN3    0x183
#define GUI_ID_DROPDOWN4    0x184
#define GUI_ID_DROPDOWN5    0x185
#define GUI_ID_DROPDOWN6    0x186
#define GUI_ID_DROPDOWN7    0x187
#define GUI_ID_DROPDOWN8    0x188
#define GUI_ID_DROPDOWN9    0x189
```

### 6.2.7.3 Notification codes

The following events are sent from the widget to its parent window as part of a WM\_NOTIFY\_PARENT message:

| Message                         | Description  |
|---------------------------------|--|
| DROPDOWN_NOTIFICATION_COLLAPSED | DROPDOWN has been collapsed.   |
| DROPDOWN_NOTIFICATION_EXPANDED  | DROPDOWN has been expanded.  |
| WM_NOTIFICATION_CLICKED         | DROPDOWN has been clicked.   |
| WM_NOTIFICATION_RELEASED        | DROPDOWN has been released.  |
| WM_NOTIFICATION_MOVED_OUT       | DROPDOWN has been clicked and pointer has been moved out of the widget without releasing.      |
| WM_NOTIFICATION_SCROLL_CHANGED  | The scroll position of the optional scroll bar of the opened DROPDOWN widget has been changed. |
| WM_NOTIFICATION_SEL_CHANGED     | The selection of the DROPDOWN list has been changed.   |

### 6.2.7.4 Keyboard reaction

The widget reacts to the following keys if it has the input focus:

| Key           | Reaction   |
|---------------|--|
| GUI_KEY_ENTER | Selects an item from the open DROPDOWN list and closes the list. |
| GUI_KEY_SPACE | Opens the DROPDOWN list.   |

## 6.2.7.5 DROPDOWN API

The table below lists the available emWin DROPDOWN-related routines in alphabetical order. Detailed descriptions of the routines follow.

### Functions

| Routine                                 | Description   |
|---|---|
| <code>DROPDOWN_AddString()</code>       | Adds a new element to the DROPDOWN widget.  |
| <code>DROPDOWN_Clear()</code>           | Removes all text items from the DROPDOWN.   |
| <code>DROPDOWN_Collapse()</code>        | Closes the DROPDOWN list.   |
| <code>DROPDOWN_Create()</code>          | Creates a DROPDOWN widget. (Obsolete)   |
| <code>DROPDOWN_CreateEx()</code>        | Creates a DROPDOWN widget.  |
| <code>DROPDOWN_CreateIndirect()</code>  | Creates a DROPDOWN widget from a resource table entry.                                      |
| <code>DROPDOWN_CreateUser()</code>      | Creates a DROPDOWN widget using extra bytes as user data.                                   |
| <code>DROPDOWN_DecSel()</code>          | Decrements selection.   |
| <code>DROPDOWN_DecSelExp()</code>       | Decrements selection in expanded state.   |
| <code>DROPDOWN_DeleteItem()</code>      | Deletes the given item of the DROPDOWN widget.  |
| <code>DROPDOWN_EnableMotion()</code>    | Enables motion support for the given DROPDOWN widget.                                       |
| <code>DROPDOWN_Expand()</code>          | Opens the list of the DROPDOWN widget.  |
| <code>DROPDOWN_GetBkColor()</code>      | Returns the background color of the given DROPDOWN widget.                                  |
| <code>DROPDOWN_GetColor()</code>        | Returns the color used for either the button or the arrow.                                  |
| <code>DROPDOWN_GetDefaultFont()</code>  | Returns the default font of DROPDOWN widgets.   |
| <code>DROPDOWN_GetFont()</code>         | Returns the font currently used by the widget.  |
| <code>DROPDOWN_GetItemDisabled()</code> | Returns the state of the given item.  |
| <code>DROPDOWN_GetItemText()</code>     | Returns the text of a specific item of the given DROPDOWN widget.                           |
| <code>DROPDOWN_GetListbox()</code>      | Returns the handle of the attached LISTBOX widget in expanded state.                        |
| <code>DROPDOWN_GetNumItems()</code>     | Returns the number of items in the given DROPDOWN widget.                                   |
| <code>DROPDOWN_GetSel()</code>          | Returns the number of the currently selected item in a specified DROPDOWN widget.           |
| <code>DROPDOWN_GetSelExp()</code>       | Returns the index of the currently selected item of the attached LISTBOX in expanded state. |
| <code>DROPDOWN_GetTextColor()</code>    | Returns the color of the text.  |
| <code>DROPDOWN_GetUserData()</code>     | Retrieves the data set with <code>DROPDOWN_SetUserData()</code> .                           |
| <code>DROPDOWN_IncSel()</code>          | Increments selection.   |

| Routine  | Description   |
|--|---|
| <code>DROPDOWN_IncSelExp()</code>                | Increments selection in expanded state.   |
| <code>DROPDOWN_InsertString()</code>             | Inserts a string to the DROPDOWN widget at the given position.                      |
| <code>DROPDOWN_SetAutoScroll()</code>            | Enables the automatic use of a vertical scroll bar in the DROPDOWN widget.          |
| <code>DROPDOWN_SetBkColor()</code>               | Sets the background color of the given DROPDOWN widget.                             |
| <code>DROPDOWN_SetColor()</code>                 | Sets the color of the button or the arrow of the given DROPDOWN widget.             |
| <code>DROPDOWN_SetDefaultColor()</code>          | Sets the default colors for the arrow and the button of new DROPDOWN widgets.       |
| <code>DROPDOWN_SetDefaultFont()</code>           | Sets the default font used for new DROPDOWN widgets.                                |
| <code>DROPDOWN_SetDefaultScrollbarColor()</code> | Sets the default colors used for the optional scroll bar in the DROPDOWN widget.    |
| <code>DROPDOWN_SetFont()</code>                  | Sets the font used to display the given DROPDOWN widget.                            |
| <code>DROPDOWN_SetItemDisabled()</code>          | Sets the enabled state of the given item.   |
| <code>DROPDOWN_SetItemSpacing()</code>           | Sets an additional spacing below the items of the DROPDOWN widget.                  |
| <code>DROPDOWN_SetListHeight()</code>            | Sets the height in pixels to be used for the expanded list of the DROPDOWN widget.  |
| <code>DROPDOWN_SetScrollbarColor()</code>        | Sets the colors of the optional scroll bar in the DROPDOWN widget.                  |
| <code>DROPDOWN_SetScrollbarWidth()</code>        | Sets the width of the scroll bars used by the list of the given DROPDOWN widget.    |
| <code>DROPDOWN_SetSel()</code>                   | Sets the current selection.   |
| <code>DROPDOWN_SetSelExp()</code>                | Sets the selected item of the attached LISTBOX in expanded state.                   |
| <code>DROPDOWN_SetText()</code>                  | Removes all text items from the DROPDOWN and replaces it with new text items.       |
| <code>DROPDOWN_SetTextAlign()</code>             | Sets the alignment used to display the text of the DROPDOWN widget in closed state. |
| <code>DROPDOWN_SetTextColor()</code>             | Sets the text color of the given DROPDOWN widget.                                   |
| <code>DROPDOWN_SetTextHeight()</code>            | Sets the height of the rectangle used to display the dropdown text in closed state. |
| <code>DROPDOWN_SetUpMode()</code>                | Enables opening of the list to the upper side of the DROPDOWN widget.               |
| <code>DROPDOWN_SetUserData()</code>              | Sets the extra data of a DROPDOWN widget.   |

## Defines

| Group of defines                         | Description                                 |
|--|---|
| <code>DROPDOWN color indexes</code>      | Color indexes for DROPDOWN widget.          |
| <code>DROPDOWN create flags</code>       | Create flags for DROPDOWN widget.           |
| <code>DROPDOWN notification codes</code> | Notification codes sent by DROPDOWN widget. |

## 6.2.7.5.1 Functions

### 6.2.7.5.1.1 DROPDOWN\_AddString()

#### Description

Adds a new element to the DROPDOWN widget.

#### Prototype

```
void DROPDOWN_AddString(      DROPDOWN_Handle  hObj,  
                             const char      * s);
```

#### Parameters

| Parameter         | Description                   |
|-------------------|-------------------------------|
| <code>hObj</code> | Handle of DROPDOWN widget.    |
| <code>s</code>    | Pointer to string to be added |

### 6.2.7.5.1.2 DROPDOWN\_Clear()

#### Description

Removes all text items from the DROPDOWN.

#### Prototype

```
void DROPDOWN_Clear(DROPDOWN_Handle hObj);
```

#### Parameters

| Parameter            | Description                |
|----------------------|----------------------------|
| <a href="#">hObj</a> | Handle of DROPDOWN widget. |



### 6.2.7.5.1.3 DROPDOWN\_Collapse()

#### Description

Closes the dropdown list of the DROPDOWN widget.

#### Prototype

```
void DROPDOWN_Collapse(DROPDOWN_Handle hObj);
```

#### Parameters

| Parameter            | Description                |
|----------------------|----------------------------|
| <a href="#">hObj</a> | Handle of DROPDOWN widget. |

### 6.2.7.5.1.4 DROPDOWN\_Create()

#### Note

This function is **deprecated**, `DROPDOWN_CreateEx()` should be used instead.

#### Description

Creates a DROPDOWN widget of a specified size at a specified location.

#### Prototype

```
DROPDOWN_Handle DROPDOWN_Create(WM_HWIN hWinParent,
                                int      x0,
                                int      y0,
                                int      xSize,
                                int      ySize,
                                int      Flags);
```

#### Parameters

| Parameter               | Description  |
|-------------------------|--|
| <code>hWinParent</code> | Handle of parent window  |
| <code>x0</code>         | Leftmost pixel of the DROPDOWN widget (in parent coordinates).   |
| <code>y0</code>         | Topmost pixel of the DROPDOWN widget (in parent coordinates).  |
| <code>xSize</code>      | Horizontal size of the DROPDOWN widget (in pixels).  |
| <code>ySize</code>      | Vertical size of the DROPDOWN widget in open state (in pixels).  |
| <code>Flags</code>      | Window create flags. Typically, <code>WM_CF_SHOW</code> to make the widget visible immediately (refer to <i>Window create flags</i> on page 977 for a list of available parameter values). |

#### Return value

Handle of the created DROPDOWN widget; 0 if the function fails.

#### Additional information

The `ySize` of the widget in closed state depends on the font used to create the widget. You can not set the `ySize` of a closed DROPDOWN widget.

### 6.2.7.5.1.5 DROPDOWN\_CreateEx()

#### Description

Creates a DROPDOWN widget of a specified size at a specified location.

#### Prototype

```
DROPDOWN_Handle DROPDOWN_CreateEx(int    x0,
                                     int    y0,
                                     int    xSize,
                                     int    ySize,
                                     WM_HWIN hParent,
                                     int    WinFlags,
                                     int    ExFlags,
                                     int    Id);
```

#### Parameters

| Parameter             | Description  |
|-----------------------|--|
| <code>x0</code>       | Leftmost pixel of the DROPDOWN widget (in parent coordinates).   |
| <code>y0</code>       | Topmost pixel of the DROPDOWN widget (in parent coordinates).  |
| <code>xSize</code>    | Horizontal size of the DROPDOWN widget (in pixels).  |
| <code>ySize</code>    | Vertical size of the DROPDOWN widget in open state (in pixels).  |
| <code>hParent</code>  | Handle of parent window. If 0, the new DROPDOWN widget will be a child of the desktop (top-level window).  |
| <code>WinFlags</code> | Window create flags. Typically <code>WM_CF_SHOW</code> in order to make the widget visible immediately (refer to <i>Window create flags</i> on page 977 for a list of available parameter values). |
| <code>ExFlags</code>  | See <i>DROPDOWN create flags</i> on page 1155.   |
| <code>Id</code>       | Window ID of the widget.   |

#### Return value

Handle of the created DROPDOWN widget; 0 if the function fails.

### 6.2.7.5.1.6 DROPDOWN\_CreateIndirect()

#### Description

The prototype of this function is explained at the beginning of this chapter. Details can be found in the description of the function `<WIDGET>_CreateIndirect()` on page 992. The element `Para` of the according `GUI_WIDGET_CREATE_INFO` structure is not used. The element `Flags` is used according to the parameter `ExFlags` of the function `DROPDOWN_CreateEx()`.

### 6.2.7.5.1.7 DROPDOWN\_CreateUser()

#### Description

Prototype explained at the beginning of the chapter as `<WIDGET>_CreateUser()` on page 993. For a detailed description of the parameters the function `DROPDOWN_CreateEx()` can be referred to.

### 6.2.7.5.1.8 DROPDOWN\_DecSel()

#### Description

Decrement the selection, moves the selection of a specified DROPDOWN widget up by one item.

#### Prototype

```
void DROPDOWN_DecSel(DROPDOWN_Handle hObj);
```

#### Parameters

| Parameter            | Description               |
|----------------------|---------------------------|
| <a href="#">hObj</a> | Handle of DROPDOWN widget |

### 6.2.7.5.1.9 DROPDOWN\_DecSelExp()

#### Description

Decrements the selection of the attached LISTBOX in expanded state.

#### Prototype

```
void DROPDOWN_DecSelExp(DROPDOWN_Handle hObj);
```

#### Parameters

| Parameter            | Description               |
|----------------------|---------------------------|
| <a href="#">hObj</a> | Handle of DROPDOWN widget |

### 6.2.7.5.1.10 DROPDOWN\_DeleteItem()

#### Description

Deletes the given item of the DROPDOWN widget.

#### Prototype

```
void DROPDOWN_DeleteItem(DROPDOWN_Handle hObj,  
                        unsigned int Index);
```

#### Parameters

| Parameter             | Description                                 |
|-----------------------|---|
| <a href="#">hObj</a>  | Handle of DROPDOWN widget.                  |
| <a href="#">Index</a> | Zero based index of the item to be deleted. |

#### Additional information

If the index is greater than the number of items  $< 1$  the function returns immediately.



### 6.2.7.5.1.11 DROPDOWN\_EnableMotion()

#### Description

Enables motion support for the given DROPDOWN widget.

#### Prototype

```
void DROPDOWN_EnableMotion(DROPDOWN_Handle hObj,  
                           int             Flags);
```

#### Parameters

| Parameter          | Description  |
|--------------------|--|
| <code>hObj</code>  | Handle of DROPDOWN widget.   |
| <code>Flags</code> | DROPDOWN_CF_MOTION for motion support on vertical axis, 0 for disabling. |

#### Additional information

If motion support isn't enabled for the window manager, it will be activated automatically.

Note that motion support cannot be used in conjunction with scrollbars. This means that enabling motion support on one axis will remove a scrollbar attached to the same axis.

### 6.2.7.5.1.12 DROPDOWN\_Expand()

#### Description

Opens the list of the DROPDOWN widget.

#### Prototype

```
void DROPDOWN_Expand(DROPDOWN_Handle hObj);
```

#### Parameters

| Parameter            | Description                |
|----------------------|----------------------------|
| <a href="#">hObj</a> | Handle of DROPDOWN widget. |

#### Additional information

The DROPDOWN list remains open until an element has been selected or the focus has been lost.

### 6.2.7.5.1.13 DROPDOWN\_GetBkColor()

#### Description

Returns the background color of the given DROPDOWN widget.

#### Prototype

```
GUI_COLOR DROPDOWN_GetBkColor(DROPDOWN_Handle hObj,  
                               unsigned int    Index);
```

#### Parameters

| Parameter             | Description   |
|-----------------------|---|
| <a href="#">hObj</a>  | Handle of DROPDOWN widget.  |
| <a href="#">Index</a> | <a href="#">Index</a> for background color. See <i>DROPDOWN color indexes</i> on page 1154 for a full list of permitted values. |

#### Return value

The background color used with the corresponding index value.

### 6.2.7.5.1.14 DROPDOWN\_GetColor()

#### Description

Returns the color used for either the button or the arrow.

#### Prototype

```
GUI_COLOR DROPDOWN_GetColor(DROPDOWN_Handle hObj,
                             unsigned int   Index);
```

#### Parameters

| Parameter             | Description  |
|-----------------------|--|
| <a href="#">hObj</a>  | Handle of DROPDOWN widget.                                   |
| <a href="#">Index</a> | <a href="#">Index</a> for background color. See table below. |

| Permitted values for parameter <a href="#">Index</a> |   |
|--|---|
| DROPDOWN_CI_ARROW                                    | Color of small arrow within the button. |
| DROPDOWN_CI_BUTTON                                   | Button color.                           |

#### Return value

The color of the button or the arrow.

### 6.2.7.5.1.15 DROPDOWN\_GetDefaultFont()

#### Description

Returns the default font of DROPDOWN widgets.

#### Prototype

```
GUI_FONT *DROPDOWN_GetDefaultFont(void);
```

#### Return value

Returns a pointer to the default font used by DROPDOWN widgets.

### 6.2.7.5.1.16 DROPDOWN\_GetFont()

#### Description

Returns the font currently used by the widget.

#### Prototype

```
GUI_FONT *DROPDOWN_GetFont(DROPDOWN_Handle hObj);
```

#### Parameters

| Parameter            | Description               |
|----------------------|---------------------------|
| <a href="#">hObj</a> | Handle of DROPDOWN widget |

#### Return value

A pointer to the currently set font.

### 6.2.7.5.1.17 DROPDOWN\_GetItemDisabled()

#### Description

Returns the state of the given item.

#### Prototype

```
unsigned DROPDOWN_GetItemDisabled(DROPDOWN_Handle hObj,  
                                  unsigned Index);
```

#### Parameters

| Parameter             | Description                   |
|-----------------------|-------------------------------|
| <a href="#">hObj</a>  | Handle of DROPDOWN widget     |
| <a href="#">Index</a> | Zero-based index of the item. |

#### Return value

1 if the given item is disabled  
0 if not.

### 6.2.7.5.1.18 DROPDOWN\_GetItemText()

#### Description

Returns the text of a specific item of the given DROPDOWN widget.

#### Prototype

```
int DROPDOWN_GetItemText(DROPDOWN_Handle hObj,
                        unsigned Index,
                        char * pBuffer,
                        int MaxSize);
```

#### Parameters

| Parameter               | Description  |
|-------------------------|--|
| <a href="#">hObj</a>    | Handle of DROPDOWN widget  |
| <a href="#">Index</a>   | Zero-based index of the item.  |
| <a href="#">pBuffer</a> | Pointer to a char buffer which is filled with the text.                  |
| <a href="#">MaxSize</a> | Maximum number of chars which can be stored by <a href="#">pBuffer</a> . |

#### Return value

0        on success  
1        on error.



### 6.2.7.5.1.19 DROPDOWN\_GetListbox()

#### Description

Returns the handle of the attached LISTBOX widget in expanded state.

#### Prototype

```
LISTBOX_Handle DROPDOWN_GetListbox(DROPDOWN_Handle hObj);
```

#### Parameters

| Parameter            | Description                |
|----------------------|----------------------------|
| <a href="#">hObj</a> | Handle of DROPDOWN widget. |

#### Return value

Handle of the attached LISTBOX widget in expanded state, 0 if DROPDOWN is in collapsed state.

### 6.2.7.5.1.20 DROPDOWN\_GetNumItems()

#### Description

Returns the number of items in the given DROPDOWN widget.

#### Prototype

```
int DROPDOWN_GetNumItems(DROPDOWN_Handle hObj);
```

#### Parameters

| Parameter            | Description                |
|----------------------|----------------------------|
| <a href="#">hObj</a> | Handle of DROPDOWN widget. |

#### Return value

Number of items in the given DROPDOWN widget.

### 6.2.7.5.1.21 DROPDOWN\_GetSel()

#### Description

Returns the number of the currently selected item in a specified DROPDOWN widget.

#### Prototype

```
int DROPDOWN_GetSel(DROPDOWN_Handle hObj);
```

#### Parameters

| Parameter            | Description                |
|----------------------|----------------------------|
| <a href="#">hObj</a> | Handle of DROPDOWN widget. |

#### Return value

Number of the currently selected item.

### 6.2.7.5.1.22 DROPDOWN\_GetSelExp()

#### Description

Returns the index of the currently selected item of the attached LISTBOX in expanded state.

#### Prototype

```
int DROPDOWN_GetSelExp(DROPDOWN_Handle hObj);
```

#### Parameters

| Parameter            | Description                |
|----------------------|----------------------------|
| <a href="#">hObj</a> | Handle of DROPDOWN widget. |

#### Return value

Index of the currently selected item.

### 6.2.7.5.1.23 DROPDOWN\_GetTextColor()

#### Description

Returns the color used for text to be displayed.

#### Prototype

```
GUI_COLOR DROPDOWN_GetTextColor(DROPDOWN_Handle hObj,  
                                unsigned int    Index);
```

#### Parameters

| Parameter             | Description   |
|-----------------------|---|
| <a href="#">hObj</a>  | Handle of DROPDOWN widget.  |
| <a href="#">Index</a> | <a href="#">Index</a> for background color. See <i>DROPDOWN color indexes</i> on page 1154 for a full list of permitted values. |

#### Return value

The color of the text corresponding to the given index.

#### 6.2.7.5.1.24 DROPDOWN\_GetUserData()

##### **Description**

Prototype explained at the beginning of the chapter as `<WIDGET>_GetUserData()` on page 994.

### 6.2.7.5.1.25 DROPDOWN\_IncSel()

#### Description

Increment the selection, moves the selection of a specified DROPDOWN widget down by one item.

#### Prototype

```
void DROPDOWN_IncSel(DROPDOWN_Handle hObj);
```

#### Parameters

| Parameter            | Description                |
|----------------------|----------------------------|
| <a href="#">hObj</a> | Handle of DROPDOWN widget. |

### 6.2.7.5.1.26 DROPDOWN\_IncSelExp()

#### Description

Increments the selection of the attached LISTBOX in expanded state.

#### Prototype

```
void DROPDOWN_IncSelExp(DROPDOWN_Handle hObj);
```

#### Parameters

| Parameter            | Description                |
|----------------------|----------------------------|
| <a href="#">hObj</a> | Handle of DROPDOWN widget. |



### 6.2.7.5.1.27 DROPDOWN\_InsertString()

#### Description

Inserts a string to the DROPDOWN widget at the given position.

#### Prototype

```
void DROPDOWN_InsertString(DROPDOWN_Handle hObj,  
                           const char * s,  
                           unsigned int Index);
```

#### Parameters

| Parameter             | Description                           |
|-----------------------|---------------------------------------|
| <a href="#">hObj</a>  | Handle of DROPDOWN widget.            |
| <a href="#">s</a>     | Pointer to the string to be inserted. |
| <a href="#">Index</a> | Zero based index of the position.     |

#### Additional information

If the given index is greater than the number of items the string will be appended to the end of the dropdown list.

### 6.2.7.5.1.28 DROPDOWN\_SetAutoScroll()

#### Description

Enables the automatic use of a vertical scroll bar in the DROPDOWN widget.

#### Prototype

```
void DROPDOWN_SetAutoScroll(DROPDOWN_Handle hObj,
                           int OnOff);
```

#### Parameters

| Parameter             | Description                |
|-----------------------|----------------------------|
| <a href="#">hObj</a>  | Handle of DROPDOWN widget. |
| <a href="#">OnOff</a> | See table below.           |

| Permitted values for parameter <a href="#">OnOff</a> |  |
|--|--|
| 0  | Disable automatic use of a scroll bar. |
| 1  | Enable automatic use of a scroll bar.  |

#### Additional information

If enabled the DROPDOWN widget checks if all elements fits into the listbox. If not a vertical scroll bar will be added.

### 6.2.7.5.1.29 DROPDOWN\_SetBkColor()

| Before  | After   |
|---|---|
|  |  |

#### Description

Sets the background color of the given DROPDOWN widget.

#### Prototype

```
void DROPDOWN_SetBkColor(DROPDOWN_Handle hObj,
                        unsigned int      Index,
                        GUI_COLOR         Color);
```

#### Parameters

| Parameter          | Description  |
|--------------------|--|
| <code>hObj</code>  | Handle of DROPDOWN widget.   |
| <code>Index</code> | <code>Index</code> for background color. See <i>DROPDOWN color indexes</i> on page 1154 for a full list of permitted values. |
| <code>Color</code> | <code>Color</code> to be set.  |

### 6.2.7.5.1.30 DROPDOWN\_SetColor()

| Before  | After   |
|---|---|
|  |  |

#### Description

Sets the color of the button or the arrow of the given DROPDOWN widget.

#### Prototype

```
void DROPDOWN_SetColor(DROPDOWN_Handle hObj,
                      unsigned int   Index,
                      GUI_COLOR      Color);
```

#### Parameters

| Parameter          | Description  |
|--------------------|--|
| <code>hObj</code>  | Handle of DROPDOWN widget.                           |
| <code>Index</code> | <code>Index</code> of desired item. See table below. |
| <code>Color</code> | <code>Color</code> to be used.                       |

| Permitted values for parameter <code>Index</code> |  |
|---|--|
| <code>DROPDOWN_CI_ARROW</code>                    | <code>Color</code> of small arrow within the button. |
| <code>DROPDOWN_CI_BUTTON</code>                   | Button color.  |

### 6.2.7.5.1.31 DROPDOWN\_SetDefaultColor()

#### Description

Sets the default colors for the arrow and the button of new DROPDOWN widgets.

#### Prototype

```
GUI_COLOR DROPDOWN_SetDefaultColor(int Index,  
GUI_COLOR Color);
```

#### Parameters

| Parameter             | Description                                    |
|-----------------------|--|
| <a href="#">Index</a> | Refer to <a href="#">DROPDOWN_SetColor()</a> . |
| <a href="#">Color</a> | <a href="#">Color</a> to be used.              |

### 6.2.7.5.1.32 DROPDOWN\_SetDefaultFont()

#### Description

Sets the default font used for new DROPDOWN widgets.

#### Prototype

```
void DROPDOWN_SetDefaultFont(const GUI_FONT * pFont);
```

#### Parameters

| Parameter          | Description                    |
|--------------------|--------------------------------|
| <code>pFont</code> | Pointer to GUI_FONT structure. |

### 6.2.7.5.1.33 DROPDOWN\_SetDefaultScrollbarColor()

#### Description

Sets the default colors used for the optional scroll bar in the DROPDOWN widget.

#### Prototype

```
GUI_COLOR DROPDOWN_SetDefaultScrollbarColor(int Index,  
                                             GUI_COLOR Color);
```

#### Parameters

| Parameter             | Description   |
|-----------------------|---|
| <a href="#">Index</a> | Refer to <a href="#">DROPDOWN_SetScrollbarColor()</a> . |
| <a href="#">Color</a> | <a href="#">Color</a> to be used.                       |

### 6.2.7.5.1.34 DROPDOWN\_SetFont()

#### Description

Sets the font used to display the given DROPDOWN widget.

#### Prototype

```
void DROPDOWN_SetFont(      DROPDOWN_Handle  hObj,  
                           const GUI_FONT    * pFont);
```

#### Parameters

| Parameter          | Description               |
|--------------------|---------------------------|
| <code>hObj</code>  | Handle of DROPDOWN widget |
| <code>pFont</code> | Pointer to the font.      |

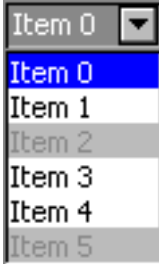

### 6.2.7.5.1.35 DROPDOWN\_SetItemDisabled()

| Before  | After   |
|---|---|
|  |  |

#### Description

Sets the enabled state of the given item.

#### Prototype

```
void DROPDOWN_SetItemDisabled(DROPDOWN_Handle hObj,
                             unsigned Index,
                             int OnOff);
```

#### Parameters

| Parameter          | Description                    |
|--------------------|--------------------------------|
| <code>hObj</code>  | Handle of DROPDOWN widget      |
| <code>Index</code> | Zero-based index of the item.  |
| <code>OnOff</code> | 1 for enabled, 0 for disabled. |

### 6.2.7.5.1.36 DROPDOWN\_SetItemSpacing()

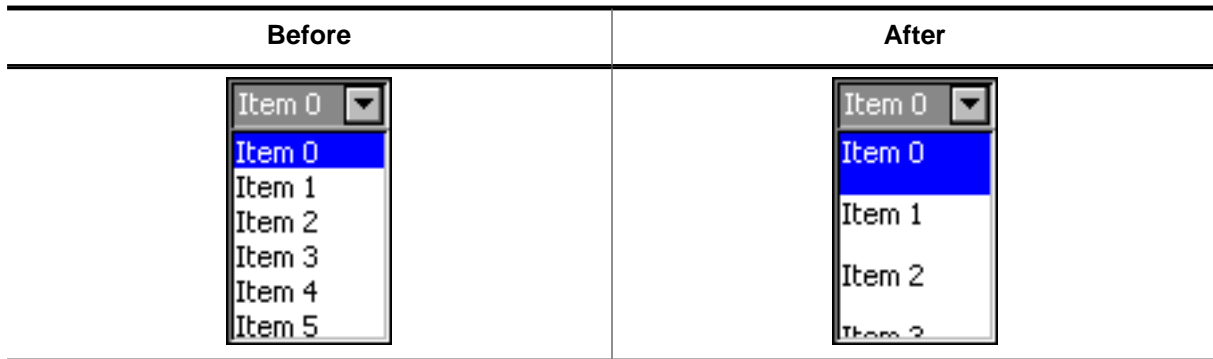

#### Description

Sets an additional spacing below the items of the DROPDOWN widget.

#### Prototype

```
void DROPDOWN_SetItemSpacing(DROPDOWN_Handle hObj,
                             unsigned Value);
```

#### Parameters

| Parameter          | Description   |
|--------------------|---|
| <code>hObj</code>  | Handle of DROPDOWN widget   |
| <code>Value</code> | Number of pixels used as additional space between the items of the DROPDOWN widget. |

### 6.2.7.5.1.37 DROPDOWN\_SetListHeight()

#### Description

Sets the height in pixels to be used for the expanded list of the DROPDOWN widget.

#### Prototype

```
int DROPDOWN_SetListHeight(DROPDOWN_Handle hObj,  
                           unsigned      Height);
```

#### Parameters

| Parameter           | Description                     |
|---------------------|---------------------------------|
| <code>hObj</code>   | Handle of DROPDOWN widget       |
| <code>Height</code> | <code>Height</code> to be used. |

#### Return value

Previously used height for the DROPDOWN list in pixels.

### 6.2.7.5.1.38 DROPDOWN\_SetScrollbarColor()

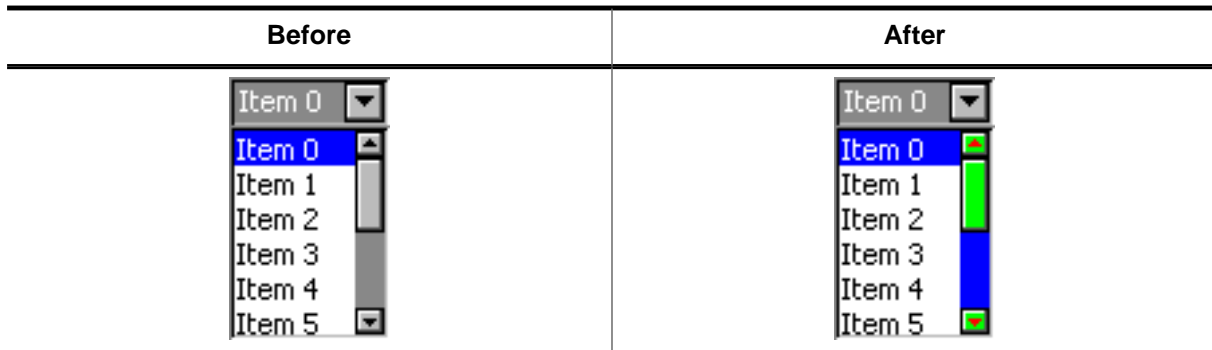

#### Description

Sets the colors of the optional scroll bar in the DROPDOWN widget.

#### Prototype

```
void DROPDOWN_SetScrollbarColor(DROPDOWN_Handle hObj,
                                unsigned Index,
                                GUI_COLOR Color);
```

#### Parameters

| Parameter          | Description  |
|--------------------|--|
| <code>hObj</code>  | Handle of DROPDOWN widget  |
| <code>Index</code> | <code>Index</code> of desired item. See <i>SCROLLBAR color indexes</i> on page 2449 for a full list of permitted values. |
| <code>Color</code> | <code>Color</code> to be used.   |

### 6.2.7.5.1.39 DROPDOWN\_SetScrollbarWidth()

#### Description

Sets the width of the scroll bars used by the list of the given DROPDOWN widget.

#### Prototype

```
void DROPDOWN_SetScrollbarWidth(DROPDOWN_Handle hObj,  
                                unsigned         Width);
```

#### Parameters

| Parameter          | Description   |
|--------------------|---|
| <code>hObj</code>  | Handle of DROPDOWN widget   |
| <code>Width</code> | <code>Width</code> of the scroll bar(s) used by the dropdown list of the given DROPDOWN widget. |

#### 6.2.7.5.1.40 DROPDOWN\_SetSel()

##### Description

Sets the selected item of a specified DROPDOWN widget.

##### Prototype

```
void DROPDOWN_SetSel(DROPDOWN_Handle hObj,  
                    int Sel);
```

##### Parameters

| Parameter         | Description               |
|-------------------|---------------------------|
| <code>hObj</code> | Handle of DROPDOWN widget |
| <code>Sel</code>  | Element to be selected.   |

### 6.2.7.5.1.41 DROPDOWN\_SetSelExp()

#### Description

Sets the selected item of the attached LISTBOX in expanded state.

#### Prototype

```
void DROPDOWN_SetSelExp(DROPDOWN_Handle hObj,  
                        int Sel);
```

#### Parameters

| Parameter         | Description               |
|-------------------|---------------------------|
| <code>hObj</code> | Handle of DROPDOWN widget |
| <code>Sel</code>  | Element to be selected.   |

### 6.2.7.5.1.42 DROPDOWN\_SetText()

#### Description

Removes all text items from the DROPDOWN and replaces it with new text items.

#### Prototype

```
void DROPDOWN_SetText(      DROPDOWN_Handle  hObj,  
                           const GUI_ConstString * ppText);
```

#### Parameters

| Parameter           | Description   |
|---------------------|---|
| <code>hObj</code>   | Handle of DROPDOWN widget.  |
| <code>ppText</code> | Pointer to an array of string pointers containing the elements to be displayed. Last element of the array must be <code>NULL</code> . |



### 6.2.7.5.1.43 DROPDOWN\_SetTextAlign()

| Before  | After  |
|---|--|
|  |  |

#### Description

Sets the alignment used to display the text of the DROPDOWN widget in closed state.

#### Prototype

```
void DROPDOWN_SetTextAlign(DROPDOWN_Handle hObj,
                           int Align);
```

#### Parameters

| Parameter          | Description  |
|--------------------|--|
| <code>hObj</code>  | Handle of DROPDOWN widget                                    |
| <code>Align</code> | Alignment used to display the dropdown text in closed state. |

#### 6.2.7.5.1.44 DROPDOWN\_SetTextColor()

##### Description

Sets the background color of the given DROPDOWN widget.

##### Prototype

```
void DROPDOWN_SetTextColor(DROPDOWN_Handle hObj,  
                           unsigned int    Index,  
                           GUI_COLOR      Color);
```

##### Parameters

| Parameter             | Description   |
|-----------------------|---|
| <a href="#">hObj</a>  | Handle of DROPDOWN widget   |
| <a href="#">Index</a> | <a href="#">Index</a> for background color. See <i>DROPDOWN color indexes</i> on page 1154 for a full list of permitted values. |
| <a href="#">Color</a> | <a href="#">Color</a> to be set.  |

### 6.2.7.5.1.45 DROPDOWN\_SetTextHeight()

| Before  | After  |
|---|--|
|  |  |

#### Description

Sets the height of the rectangle used to display the text of DROPDOWN widget in closed state.

#### Prototype

```
void DROPDOWN_SetTextHeight(DROPDOWN_Handle hObj,
                             unsigned TextHeight);
```

#### Parameters

| Parameter  | Description   |
|------------|---|
| hObj       | Handle of DROPDOWN widget.  |
| TextHeight | Height of the rectangle used to display the text in closed state. |

#### Additional information

Per default the height of the DROPDOWN widget depends on the used font. Using this function with `TextHeight > 0` means the given value should be used. `TextHeight = 0` means the default behavior should be used.

### 6.2.7.5.1.46 DROPDOWN\_SetUpMode()

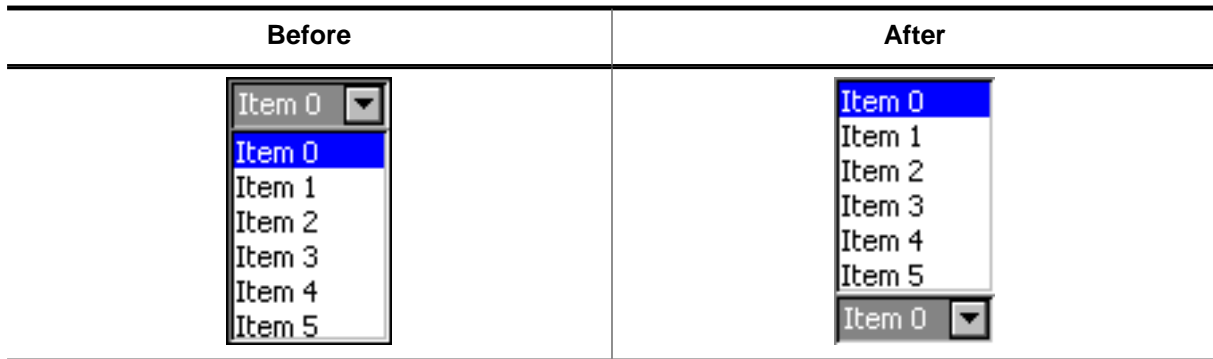

#### Description

Enables opening of the list to the upper side of the DROPDOWN widget.

#### Prototype

```
int DROPDOWN_SetUpMode(DROPDOWN_Handle hObj,
                       int OnOff);
```

#### Parameters

| Parameter          | Description                                |
|--------------------|--|
| <code>hObj</code>  | Handle of DROPDOWN widget                  |
| <code>OnOff</code> | 1 for enabling, 0 for disabling 'up mode'. |

#### 6.2.7.5.1.47 DROPDOWN\_SetUserData()

##### Description

Prototype explained at the beginning of the chapter as `<WIDGET>_SetUserData()` on page 995.

## 6.2.7.5.2 Defines

### 6.2.7.5.2.1 DROPDOWN color indexes

#### Description

Color indexes for DROPDOWN widget.

#### Definition

```
#define DROPDOWN_CI_UNSEL      0
#define DROPDOWN_CI_SEL       1
#define DROPDOWN_CI_SELFOCUS  2
```

#### Symbols

| Definition                           | Description                      |
|--------------------------------------|----------------------------------|
| <a href="#">DROPDOWN_CI_UNSEL</a>    | Unselected element.              |
| <a href="#">DROPDOWN_CI_SEL</a>      | Selected element, without focus. |
| <a href="#">DROPDOWN_CI_SELFOCUS</a> | Selected element, with focus.    |

### 6.2.7.5.2.2 DROPDOWN create flags

#### Description

These flags can be used when creating a DROPDOWN widget via `DROPDOWN_CreateEx()`. 0 can be specified for the `ExFlags` parameter, if no flags should be used.

#### Definition

```
#define DROPDOWN_CF_AUTOSCROLLBAR    (1 << 0)
#define DROPDOWN_CF_UP               (1 << 1)
#define DROPDOWN_CF_MOTION          (1 << 2)
```

#### Symbols

| Definition                             | Description  |
|--|--|
| <code>DROPDOWN_CF_AUTOSCROLLBAR</code> | Enable automatic use of a scroll bar. For details, refer to <code>DROPDOWN_SetAutoScroll()</code> .  |
| <code>DROPDOWN_CF_UP</code>            | Creates a DROPDOWN widget which opens the dropdown list above the widget. This flag is useful if the space below the widget is not sufficient for the dropdown list. |
| <code>DROPDOWN_CF_MOTION</code>        | Enables motion support on the vertical axis.   |

### 6.2.7.5.2.3 DROPDOWN notification codes

#### Description

Notifications sent by DROPDOWN widget to its parent widget through a WM\_NOTIFY\_PARENT message.

#### Definition

```
#define DROPDOWN_NOTIFICATION_EXPANDED    (WM_NOTIFICATION_WIDGET + 0)
#define DROPDOWN_NOTIFICATION_COLLAPSED  (WM_NOTIFICATION_WIDGET + 1)
```

#### Symbols

| Definition                                      | Description  |
|---|--|
| <a href="#">DROPDOWN_NOTIFICATION_EXPANDED</a>  | Sent when the list of the DROPDOWN has been expanded.  |
| <a href="#">DROPDOWN_NOTIFICATION_COLLAPSED</a> | Sent when the list of the DROPDOWN has been collapsed. |



### 6.2.7.6 Example

The `Sample` folder contains the following example which shows how the widget can be used:

- `WIDGET_Dropdown.c`



Note that several other examples also make use of this widget and may also be helpful to get familiar with the widget.

#### Screenshot of `WIDGET_Dropdown.c`:





## 6.2.8 EDIT: Edit widget

EDIT widgets are commonly used as the primary user interface for text input:

| Blank EDIT widget   | EDIT widget with user input  |
|---|--|
|  |  |

You can also use EDIT widgets for entering values in binary, decimal, or hexadecimal modes. A decimal-mode edit field might appear similar to those in the following table. The background color of EDIT widgets by default turns gray if disabled:

| EDIT widget with user input (decimal)   | Disabled EDIT widget  |
|---|---|
|  |  |

### Note

All EDIT-related routines are located in the file(s) `EDIT*.c`, `EDIT.h`.  
All identifiers are prefixed `EDIT`.

### 6.2.8.1 Configuration options

| Type | Macro                                | Default  | Description   |
|------|--------------------------------------|--|---|
| S    | <code>EDIT_ALIGN_DEFAULT</code>      | <code>GUI_TA_LEFT</code>   <code>GUI_TA_VCENTER</code> | Text alignment for EDIT widget.                               |
| N    | <code>EDIT_BKCOLOR0_DEFAULT</code>   | <code>0xc0c0c0</code>                                  | Background color, disabled state.                             |
| N    | <code>EDIT_BKCOLOR1_DEFAULT</code>   | <code>GUI_WHITE</code>                                 | Background color, enabled state.                              |
| N    | <code>EDIT_BORDER_DEFAULT</code>     | <code>1</code>   | Width of border, in pixels.                                   |
| S    | <code>EDIT_FONT_DEFAULT</code>       | <code>&amp;GUI_Font13_1</code>                         | Font used for edit field text.                                |
| N    | <code>EDIT_TEXTCOLOR0_DEFAULT</code> | <code>GUI_BLACK</code>                                 | Text color, disabled state.                                   |
| N    | <code>EDIT_TEXTCOLOR1_DEFAULT</code> | <code>GUI_BLACK</code>                                 | Text color, enabled state.                                    |
| N    | <code>EDIT_XOFF</code>               | <code>1</code>   | Distance in X to offset text from left border of EDIT widget. |

Available alignment flags are:

- `GUI_TA_LEFT`, `GUI_TA_RIGHT`, `GUI_TA_HCENTER` for **horizontal** alignment.
- `GUI_TA_TOP`, `GUI_TA_BOTTOM`, `GUI_TA_VCENTER` for **vertical** alignment.

### 6.2.8.2 Predefined IDs

The following symbols define IDs which may be used to make EDIT widgets distinguishable from creation.

```
#define GUI_ID_EDIT0    0x100
#define GUI_ID_EDIT1    0x101
#define GUI_ID_EDIT2    0x102
#define GUI_ID_EDIT3    0x103
#define GUI_ID_EDIT4    0x104
#define GUI_ID_EDIT5    0x105
#define GUI_ID_EDIT6    0x106
#define GUI_ID_EDIT7    0x107
#define GUI_ID_EDIT8    0x108
#define GUI_ID_EDIT9    0x109
```

### 6.2.8.3 Notification codes

The following events are sent from an EDIT widget to its parent window as part of a WM\_NOTIFY\_PARENT message:

| Message                       | Description   |
|-------------------------------|---|
| WM_NOTIFICATION_CLICKED       | Widget has been clicked.  |
| WM_NOTIFICATION_RELEASED      | Widget has been released.   |
| WM_NOTIFICATION_MOVED_OUT     | Widget has been clicked and pointer has been moved out of the widget without releasing. |
| WM_NOTIFICATION_VALUE_CHANGED | Value (content) of the EDIT widget has changed.   |

### 6.2.8.4 Keyboard reaction

The widget reacts to the following keys if it has the input focus:

| Key               | Reaction   |
|-------------------|--|
| GUI_KEY_UP        | Increases the current character. If for example the current character (the character below the cursor) is a 'A' it changes to 'B'.                                     |
| GUI_KEY_DOWN      | Decreases the current character. If for example the current character is a 'B' it changes to 'A'.  |
| GUI_KEY_RIGHT     | Moves the cursor one character to the right.   |
| GUI_KEY_LEFT      | Moves the cursor one character to the left.  |
| GUI_KEY_BACKSPACE | If the widget works in text mode, the character before the cursor is deleted.  |
| GUI_KEY_DELETE    | If the widget works in text mode, the current is deleted.  |
| GUI_KEY_INSERT    | If the widget works in text mode, this key toggles the edit mode between GUI_EDIT_MODE_OVERWRITE and GUI_EDIT_MODE_INSERT. For details, refer to EDIT_SetInsertMode(). |
| GUI_KEY_HOME      | Moves the cursor to its first position.  |
| GUI_KEY_END       | Moves the cursor to its last position.   |

## 6.2.8.5 EDIT API

The table below lists the available emWin EDIT-related routines in alphabetical order. Detailed descriptions of the routines follow.

### Functions

| Routine                                 | Description  |
|---|--|
| <code>EDIT_AddKey()</code>              | Adds user input to a specified EDIT widget.  |
| <code>EDIT_Create()</code>              | Creates an EDIT widget. (Obsolete)   |
| <code>EDIT_CreateAsChild()</code>       | Creates an EDIT widget as a child window. (Obsolete)   |
| <code>EDIT_CreateEx()</code>            | Creates an EDIT widget.  |
| <code>EDIT_CreateIndirect()</code>      | Creates an EDIT widget from resource table entry.  |
| <code>EDIT_CreateUser()</code>          | Creates an EDIT widget using extra bytes as user data.   |
| <code>EDIT_EnableAutoScroll()</code>    | Toggles automatic text scrolling of the EDIT widget.   |
| <code>EDIT_EnableBlink()</code>         | Enables/disables a blinking cursor   |
| <code>EDIT_EnableInversion()</code>     | Enables/disables an inverted cursor (default is inverting)   |
| <code>EDIT_GetBkColor()</code>          | Returns the background color of the EDIT widget.   |
| <code>EDIT_GetBorderSize()</code>       | Returns the border size of an EDIT widget.   |
| <code>EDIT_GetCharAtPixel()</code>      | Returns the character at the given pixel position.   |
| <code>EDIT_GetCursorCharPos()</code>    | Returns the character related position of the cursor.  |
| <code>EDIT_GetCursorPixelPos()</code>   | Returns the pixel related position of the cursor in window coordinates.                                  |
| <code>EDIT_GetDefaultBkColor()</code>   | Returns the default background color used for EDIT widgets.  |
| <code>EDIT_GetDefaultFont()</code>      | Returns the default font used for EDIT widgets.  |
| <code>EDIT_GetDefaultTextAlign()</code> | Returns the default text alignment used for EDIT widgets.  |
| <code>EDIT_GetDefaultTextColor()</code> | Returns the default text color used for EDIT widgets.  |
| <code>EDIT_GetFloatValue()</code>       | Returns the current value of the EDIT widget as floating point value.                                    |
| <code>EDIT_GetFont()</code>             | Returns a pointer to the used font.  |
| <code>EDIT_GetMinMax()</code>           | This function is used to retrieve the minimum and maximum value set for the EDIT widget in decimal mode. |
| <code>EDIT_GetNumChars()</code>         | Returns the number of characters of the specified EDIT widget.   |
| <code>EDIT_GetSel()</code>              | Returns the current selection.   |
| <code>EDIT_GetSelText()</code>          | Copies the selected text into a buffer.  |
| <code>EDIT_GetText()</code>             | Retrieves the user input of a specified EDIT widget.   |
| <code>EDIT_GetTextAlign()</code>        | This function returns the currently set alignment of the EDIT widget.                                    |
| <code>EDIT_GetTextColor()</code>        | Returns the text color.  |
| <code>EDIT_GetUserData()</code>         | Retrieves the data set with <code>EDIT_SetUserData()</code> .  |
| <code>EDIT_GetValue()</code>            | Returns the current value of the EDIT widget.  |
| <code>EDIT_SetBinMode()</code>          | Enables the binary edit mode of the EDIT widget.   |

| Routine                                 | Description  |
|---|--|
| <code>EDIT_SetBkColor()</code>          | Sets the background color of the EDIT widget.  |
| <code>EDIT_SetBorderSize()</code>       | Sets the border size of an EDIT widget.  |
| <code>EDIT_SetCursorAtChar()</code>     | Sets the EDIT widget cursor to a specified character position.   |
| <code>EDIT_SetCursorAtPixel()</code>    | Sets the EDIT widget cursor to a specified pixel position.   |
| <code>EDIT_SetDecMode()</code>          | Enables the decimal edit mode of the EDIT widget.  |
| <code>EDIT_SetDefaultBkColor()</code>   | Sets the default background color used for EDIT widgets.   |
| <code>EDIT_SetDefaultFont()</code>      | Sets the default font used for EDIT widgets.   |
| <code>EDIT_SetDefaultTextAlign()</code> | Sets the default text alignment for EDIT widgets.  |
| <code>EDIT_SetDefaultTextColor()</code> | Sets the default text color used for EDIT widgets.   |
| <code>EDIT_SetFloatMode()</code>        | Enables the floating point edit mode of the EDIT widget.   |
| <code>EDIT_SetFloatValue()</code>       | The function can be used to set the floating point value of the EDIT widget if working in floating point mode. |
| <code>EDIT_SetFocusable()</code>        | Sets focusability of the EDIT widget.  |
| <code>EDIT_SetFont()</code>             | Sets the used font of the EDIT widget.   |
| <code>EDIT_SetHexMode()</code>          | Enables the hexadecimal edit mode of the EDIT widget.  |
| <code>EDIT_SetInsertMode()</code>       | Enables or disables the insert mode of the EDIT widget.  |
| <code>EDIT_SetMaxLen()</code>           | Sets the maximum number of characters to be edited by the given EDIT widget.                                   |
| <code>EDIT_SetpfAddKeyEx()</code>       | Sets a function which is called to add a character.  |
| <code>EDIT_SetSel()</code>              | Sets the current selection.  |
| <code>EDIT_SetText()</code>             | Sets the text.   |
| <code>EDIT_SetTextAlign()</code>        | Sets the text alignment of the EDIT widget.  |
| <code>EDIT_SetTextColor()</code>        | Sets the text color of the EDIT widget.  |
| <code>EDIT_SetTextMode()</code>         | Sets the edit mode of the EDIT widget back to text mode.   |
| <code>EDIT_SetValue()</code>            | Sets the current value of the EDIT widget.   |
| <code>EDIT_SetUlongMode()</code>        | Enables the unsigned long decimal edit mode of the EDIT widget.  |
| <code>EDIT_SetUserData()</code>         | Sets the extra data of an EDIT widget.   |

## Defines

| Group of defines                | Description                    |
|---------------------------------|--------------------------------|
| <code>EDIT color indexes</code> | Color indexes for EDIT widget. |
| <code>EDIT flags</code>         | Flags used for EDIT widgets.   |

## 6.2.8.5.1 Functions

### 6.2.8.5.1.1 EDIT\_AddKey()

#### Description

Adds user input to a specified EDIT widget.

#### Prototype

```
void EDIT_AddKey(EDIT_Handle hObj,  
                int         Key);
```

#### Parameters

| Parameter         | Description            |
|-------------------|------------------------|
| <code>hObj</code> | Handle of EDIT widget  |
| <code>Key</code>  | Character to be added. |

#### Additional information

The specified character is added to the user input of the EDIT widget. If the last character should be erased, the key `GUI_KEY_BACKSPACE` can be used. If the maximum count of characters has been reached, another character will not be added.

### 6.2.8.5.1.2 EDIT\_Create()

#### Note

This function is **deprecated**, `EDIT_CreateEx()` should be used instead.

#### Description

Creates an EDIT widget of a specified size at a specified location.

#### Prototype

```
EDIT_Handle EDIT_Create(int x0,
                      int y0,
                      int xSize,
                      int ySize,
                      int Id,
                      int MaxLen,
                      int Flags);
```

#### Parameters

| Parameter           | Description  |
|---------------------|--|
| <code>x0</code>     | Leftmost pixel of the edit field (in parent coordinates).  |
| <code>y0</code>     | Topmost pixel of the edit field (in parent coordinates).   |
| <code>xSize</code>  | Horizontal size of the edit field (in pixels).   |
| <code>ySize</code>  | Vertical size of the edit field (in pixels).   |
| <code>Id</code>     | ID to be returned.   |
| <code>MaxLen</code> | Maximum count of characters.   |
| <code>Flags</code>  | Window create flags. Typically <code>WM_CF_SHOW</code> in order to make the widget visible immediately (refer to <i>Window create flags</i> on page 977 for a list of available parameter values). |

#### Return value

Handle of the created EDIT widget; 0 if the function fails.

### 6.2.8.5.1.3 EDIT\_CreateAsChild()

#### Note

This function is **deprecated**, `EDIT_CreateEx()` should be used instead.

#### Description

Creates an EDIT widget as a child window.

#### Prototype

```
EDIT_Handle EDIT_CreateAsChild(int    x0,
                               int    y0,
                               int    xSize,
                               int    ySize,
                               WM_HWIN hParent,
                               int    Id,
                               int    Flags,
                               int    MaxLen);
```

#### Parameters

| Parameter            | Description   |
|----------------------|---|
| <code>x0</code>      | X-position of the edit field relative to the parent window.       |
| <code>y0</code>      | Y-position of the edit field relative to the parent window.       |
| <code>xSize</code>   | Horizontal size of the edit field (in pixels).                    |
| <code>ySize</code>   | Vertical size of the edit field (in pixels).                      |
| <code>hParent</code> | Handle of parent window.  |
| <code>Id</code>      | ID to be assigned to the EDIT widget.                             |
| <code>Flags</code>   | Window create flags (see <i>Window create flags</i> on page 977). |
| <code>MaxLen</code>  | Maximum count of characters.                                      |

#### Return value

Handle of the created EDIT widget; 0 if the function fails.



### 6.2.8.5.1.4 EDIT\_CreateEx()

#### Description

Creates an EDIT widget of a specified size at a specified location.

#### Prototype

```
EDIT_Handle EDIT_CreateEx(int    x0,
                        int    y0,
                        int    xSize,
                        int    ySize,
                        WM_HWIN hParent,
                        int    WinFlags,
                        int    ExFlags,
                        int    Id,
                        int    MaxLen);
```

#### Parameters

| Parameter             | Description  |
|-----------------------|--|
| <code>x0</code>       | Leftmost pixel of the widget (in parent coordinates).  |
| <code>y0</code>       | Topmost pixel of the widget (in parent coordinates).   |
| <code>xSize</code>    | Horizontal size of the widget (in pixels).   |
| <code>ySize</code>    | Vertical size of the widget (in pixels).   |
| <code>hParent</code>  | Handle of parent window. If 0, the new EDIT widget will be a child of the desktop (top-level window).  |
| <code>WinFlags</code> | Window create flags. Typically <code>WM_CF_SHOW</code> in order to make the widget visible immediately (refer to <i>Window create flags</i> on page 977 for a list of available parameter values). |
| <code>ExFlags</code>  | Not used, reserved for future use.   |
| <code>Id</code>       | Window ID of the widget.   |
| <code>MaxLen</code>   | Maximum count of characters.   |

#### Return value

Handle of the created EDIT widget; 0 if the function fails.

### 6.2.8.5.1.5 EDIT\_CreateIndirect()

#### Description

The prototype of this function is explained at the beginning of this chapter. Details can be found in the description of the function `<WIDGET>_CreateIndirect()` on page 992. The element `Flags` is used according to the parameter `Align` of the function `EDIT_SetTextAlign()`. The element `Para` is used according to the parameter `MaxLen` of the function `EDIT_CreateEx()`.

### 6.2.8.5.1.6 EDIT\_CreateUser()

#### Description

Prototype explained at the beginning of the chapter as `<WIDGET>_CreateUser()` on page 993. For a detailed description of the parameters the function `EDIT_CreateEx()` can be referred to.

### 6.2.8.5.1.7 EDIT\_EnableAutoScroll()

#### Description

Toggles automatic text scrolling of the EDIT widget. With this mode, when text is entered or deleted and the cursor moves out of the widget, the text is automatically scrolled so that the cursor remains visible.

#### Prototype

```
void EDIT_EnableAutoScroll(EDIT_Handle hObj,  
                           int         OnOff);
```

#### Parameters

| Parameter          | Description                                   |
|--------------------|---|
| <code>hObj</code>  | Handle of EDIT widget.                        |
| <code>OnOff</code> | 1 enables automatic scrolling, 0 disables it. |

#### Additional information

Automatic text scrolling is enabled by default.

### 6.2.8.5.1.8 EDIT\_EnableBlink()

#### Description

Enables/disables a blinking cursor.

#### Prototype

```
void EDIT_EnableBlink(EDIT_Handle hObj,  
                     int         Period,  
                     int         OnOff);
```

#### Parameters

| Parameter           | Description                             |
|---------------------|---|
| <code>hObj</code>   | Handle of EDIT widget.                  |
| <code>Period</code> | Blinking period                         |
| <code>OnOff</code>  | 1 enables blinking, 0 disables blinking |

#### Additional information

This function calls `GUI_X_GetTime()`.

### 6.2.8.5.1.9 EDIT\_EnableInversion()

#### Description

Toggles between inversion mode.

#### Prototype

```
int EDIT_EnableInversion(EDIT_Handle hObj,
                        int          OnOff);
```

#### Parameters

| Parameter          | Description                               |
|--------------------|---|
| <code>hObj</code>  | Handle of EDIT widget.                    |
| <code>OnOff</code> | 1 enables inverting, 0 disables inverting |

#### Return value

Previous used mode.

0        No inversion.  
1        Inversion mode.

#### Additional information

The text cursor per default is drawn by inverting the character which is currently edited. If a cursor with a dedicated text- and background color is required, inversion can be deactivated and the functions `EDIT_SetTextColor()` and `EDIT_SetBkColor()` may be used for setting the cursor color.

### 6.2.8.5.1.10 EDIT\_GetBkColor()

#### Description

Returns the background color of the EDIT widget.

#### Prototype

```
GUI_COLOR EDIT_GetBkColor(EDIT_Handle hObj,  
                           unsigned int Index);
```

#### Parameters

| Parameter             | Description  |
|-----------------------|--|
| <a href="#">hObj</a>  | Handle of EDIT widget.   |
| <a href="#">Index</a> | Color index. See <i>EDIT color indexes</i> on page 1216 for a full list of permitted values. |

#### Return value

Background color of the EDIT widget.

### 6.2.8.5.1.11 EDIT\_GetBorderSize()

#### Description

Returns the border size of an EDIT widget.

#### Prototype

```
int EDIT_GetBorderSize(EDIT_Handle hObj);
```

#### Parameters

| Parameter            | Description            |
|----------------------|------------------------|
| <a href="#">hObj</a> | Handle of EDIT widget. |

#### Return value

= -1     Error.  
≠ -1     Border size of the EDIT widget.



### 6.2.8.5.1.12 EDIT\_GetCharAtPixel()

#### Description

Returns the character at the given pixel position.

#### Prototype

```
U16 EDIT_GetCharAtPixel(EDIT_Handle  hObj,  
                        int          x,  
                        int          y,  
                        int          * pIndex);
```

#### Parameters

| Parameter           | Description   |
|---------------------|---|
| <code>hObj</code>   | Handle of EDIT widget.  |
| <code>x</code>      | X-position.   |
| <code>y</code>      | Y-position.   |
| <code>pIndex</code> | Pointer to int. Zero-based position of the character in the string. Can be <code>NULL</code> if not needed. |

#### Return value

- = 0      No character found.
- ≠ 0     The character at the given pixel position.

### 6.2.8.5.1.13 EDIT\_GetCursorCharPos()

#### Description

Returns the character related position of the cursor.

#### Prototype

```
int EDIT_GetCursorCharPos(EDIT_Handle hObj);
```

#### Parameters

| Parameter            | Description            |
|----------------------|------------------------|
| <a href="#">hObj</a> | Handle of EDIT widget. |

#### Return value

Character related position of the cursor.

#### Additional information

The widget returns the character position if it has the focus or not. This means the cursor position is also returned, if the cursor is currently not visible in the widget.

### 6.2.8.5.1.14 EDIT\_GetCursorPixelPos()

#### Description

Returns the pixel related position of the cursor in window coordinates.

#### Prototype

```
void EDIT_GetCursorPixelPos(EDIT_Handle  hObj,  
                           int          * pxPos,  
                           int          * pyPos);
```

#### Parameters

| Parameter          | Description   |
|--------------------|---|
| <code>hObj</code>  | Handle of EDIT widget.  |
| <code>pxPos</code> | Pointer to integer variable for the X-position in window coordinates. |
| <code>pyPos</code> | Pointer to integer variable for the Y-position in window coordinates. |

#### Additional information

The widget returns the pixel position if it has the focus or not. This means the cursor position is also returned, if the cursor is currently not visible in the widget.

### 6.2.8.5.1.15 EDIT\_GetDefaultBkColor()

#### Description

Returns the default background color used for EDIT widgets.

#### Prototype

```
GUI_COLOR EDIT_GetDefaultBkColor(unsigned int Index);
```

#### Parameters

| Parameter             | Description                   |
|-----------------------|-------------------------------|
| <a href="#">Index</a> | Color index. See table below. |

#### Return value

Default background color used for EDIT widgets.

### 6.2.8.5.1.16 EDIT\_GetDefaultFont()

#### Description

Returns the default font used for EDIT widgets.

#### Prototype

```
GUI_FONT *EDIT_GetDefaultFont(void);
```

#### Return value

Default font used for EDIT widgets.

### 6.2.8.5.1.17 EDIT\_GetDefaultTextAlign()

#### Description

Returns the default text alignment used for EDIT widgets.

#### Prototype

```
int EDIT_GetDefaultTextAlign(void);
```

#### Return value

Default text alignment used for EDIT widgets.

### 6.2.8.5.1.18 EDIT\_GetDefaultTextColor()

#### Description

Returns the default text color used for EDIT widgets.

#### Prototype

```
GUI_COLOR EDIT_GetDefaultTextColor(unsigned int Index);
```

#### Parameters

| Parameter             | Description                           |
|-----------------------|---------------------------------------|
| <a href="#">Index</a> | Has to be 0, reserved for future use. |

#### Return value

Default text color used for EDIT widgets.

### 6.2.8.5.1.19 EDIT\_GetFloatValue()

#### Description

Returns the current value of the EDIT widget as floating point value.

#### Prototype

```
float EDIT_GetFloatValue(EDIT_Handle hObj);
```

#### Parameters

| Parameter            | Description            |
|----------------------|------------------------|
| <a href="#">hObj</a> | Handle of EDIT widget. |

#### Return value

The current value.

#### Additional information

The use of this function makes only sense if the edit field is in floating point edit mode.



### 6.2.8.5.1.20 EDIT\_GetFont()

#### Description

Returns a pointer to the used font.

#### Prototype

```
GUI_FONT *EDIT_GetFont(EDIT_Handle hObj);
```

#### Parameters

| Parameter            | Description            |
|----------------------|------------------------|
| <a href="#">hObj</a> | Handle of EDIT widget. |

#### Return value

Pointer to the used font.

### 6.2.8.5.1.21 EDIT\_GetMinMax()

#### Description

This function is used to retrieve the minimum and maximum value set for the EDIT widget in decimal mode.

#### Prototype

```
void EDIT_GetMinMax(EDIT_Handle  hObj,  
                   int          * pMin,  
                   int          * pMax);
```

#### Parameters

| Parameter            | Description                            |
|----------------------|--|
| <a href="#">hObj</a> | Handle of EDIT widget.                 |
| <a href="#">pMin</a> | Pointer to retrieve the minimum value. |
| <a href="#">pMax</a> | Pointer to retrieve the maximum value. |

#### Additional information

This function works only for an EDIT widget used in decimal mode that has a minimum and a maximum value set. Otherwise [pMin](#) and [pMax](#) are getting set to 0.

### 6.2.8.5.1.22 EDIT\_GetNumChars()

#### Description

Returns the number of characters of the specified EDIT widget.

#### Prototype

```
int EDIT_GetNumChars(EDIT_Handle hObj);
```

#### Parameters

| Parameter            | Description            |
|----------------------|------------------------|
| <a href="#">hObj</a> | Handle of EDIT widget. |

#### Return value

Number of characters of the specified EDIT widget.

### 6.2.8.5.1.23 EDIT\_GetSel()

#### Description

Returns the current selection.

#### Prototype

```
void EDIT_GetSel(EDIT_Handle  hObj,  
                int          * pFirstChar,  
                int          * pLastChar);
```

#### Parameters

| Parameter               | Description  |
|-------------------------|--|
| <code>hObj</code>       | Handle of EDIT widget.   |
| <code>pFirstChar</code> | Pointer to an int where the number of the first selected char will be stored in. |
| <code>pLastChar</code>  | Pointer to an int where the number of the last selected char will be stored in.  |

### 6.2.8.5.1.24 EDIT\_GetSelText()

#### Description

Copies the selected text into a buffer.

#### Prototype

```
void EDIT_GetSelText(EDIT_Handle  hObj,  
                    char        * sDest,  
                    int         MaxLen);
```

#### Parameters

| Parameter           | Description            |
|---------------------|------------------------|
| <code>hObj</code>   | Handle of EDIT widget. |
| <code>sDest</code>  | Pointer to buffer.     |
| <code>MaxLen</code> | Size of buffer.        |

### 6.2.8.5.1.25 EDIT\_GetText()

#### Description

Retrieves the user input of a specified EDIT widget.

#### Prototype

```
void EDIT_GetText (EDIT_Handle  hObj,  
                  char          * sDest,  
                  int           MaxLen);
```

#### Parameters

| Parameter              | Description            |
|------------------------|------------------------|
| <a href="#">hObj</a>   | Handle of EDIT widget. |
| <a href="#">sDest</a>  | Pointer to buffer.     |
| <a href="#">MaxLen</a> | Size of buffer.        |

### 6.2.8.5.1.26 EDIT\_GetTextAlign()

#### Description

This function returns the currently set alignment of the EDIT widget.

#### Prototype

```
int EDIT_GetTextAlign(EDIT_Handle hObj);
```

#### Parameters

| Parameter            | Description            |
|----------------------|------------------------|
| <a href="#">hObj</a> | Handle of EDIT widget. |

#### Return value

The currently set text alignment for the given EDIT widget.

### 6.2.8.5.1.27 EDIT\_GetTextColor()

#### Description

Returns the text color.

#### Prototype

```
GUI_COLOR EDIT_GetTextColor(EDIT_Handle hObj,  
                           unsigned int Index);
```

#### Parameters

| Parameter             | Description  |
|-----------------------|--|
| <a href="#">hObj</a>  | Handle of EDIT widget.   |
| <a href="#">Index</a> | Color index. See <i>EDIT color indexes</i> on page 1216 for a full list of permitted values. |

#### Return value

The currently set text color.



### 6.2.8.5.1.28 EDIT\_GetUserData()

#### Description

Prototype explained at the beginning of the chapter as `<WIDGET>_GetUserData()` on page 994.

### 6.2.8.5.1.29 EDIT\_GetValue()

#### Description

Returns the current value of the EDIT widget. The current value is only useful if the EDIT widget is in binary, decimal or hexadecimal mode.

#### Prototype

```
I32 EDIT_GetValue(EDIT_Handle hObj);
```

#### Parameters

| Parameter            | Description            |
|----------------------|------------------------|
| <a href="#">hObj</a> | Handle of EDIT widget. |

#### Return value

The current value.

### 6.2.8.5.1.30 EDIT\_SetBinMode()

#### Description

Enables the binary edit mode of the EDIT widget. The given value can be modified in the given range.

#### Prototype

```
void EDIT_SetBinMode(EDIT_Handle hEdit,  
                    U32          Value,  
                    U32          Min,  
                    U32          Max);
```

#### Parameters

| Parameter             | Description                           |
|-----------------------|---------------------------------------|
| <a href="#">hObj</a>  | Handle of EDIT widget.                |
| <a href="#">Value</a> | <a href="#">Value</a> to be modified. |
| <a href="#">Min</a>   | Minimum value.                        |
| <a href="#">Max</a>   | Maximum value.                        |

### 6.2.8.5.1.31 EDIT\_SetBkColor()

#### Description

Sets the background color of the EDIT widget.

#### Prototype

```
void EDIT_SetBkColor(EDIT_Handle hObj,  
                    unsigned int Index,  
                    GUI_COLOR Color);
```

#### Parameters

| Parameter             | Description  |
|-----------------------|--|
| <a href="#">hObj</a>  | Handle of EDIT widget.   |
| <a href="#">Index</a> | <a href="#">Color</a> index. See <i>EDIT color indexes</i> on page 1216 for a full list of permitted values. |
| <a href="#">Color</a> | <a href="#">Color</a> to be set.   |

### 6.2.8.5.1.32 EDIT\_SetCursorAtChar()

#### Description

Sets the EDIT widget cursor to a specified character position.

#### Prototype

```
void EDIT_SetCursorAtChar(EDIT_Handle hObj,  
                          int         Pos);
```

#### Parameters

| Parameter         | Description                          |
|-------------------|--------------------------------------|
| <code>hObj</code> | Handle of EDIT widget.               |
| <code>Pos</code>  | Character position to set cursor to. |

#### Additional information

The character position works as follows:

- 0: left of the first (leftmost) character,
- 1: between the first and second characters,
- 2: between the second and third characters, and so on.

### 6.2.8.5.1.33 EDIT\_SetCursorAtPixel()

#### Description

Sets the EDIT widget cursor to a specified pixel position.

#### Prototype

```
void EDIT_SetCursorAtPixel(EDIT_Handle hObj,  
                           int         xPos);
```

#### Parameters

| Parameter         | Description                      |
|-------------------|----------------------------------|
| <code>hObj</code> | Handle of EDIT widget.           |
| <code>xPos</code> | Pixel position to set cursor to. |

### 6.2.8.5.1.34 EDIT\_SetDecMode()

#### Description

Enables the decimal edit mode of the EDIT widget. The given value can be modified in the given range.

#### Prototype

```
void EDIT_SetDecMode(EDIT_Handle hEdit,
                    I32          Value,
                    I32          Min,
                    I32          Max,
                    int          Shift,
                    U8           Flags);
```

#### Parameters

| Parameter          | Description   |
|--------------------|---|
| <code>hObj</code>  | Handle of EDIT widget.  |
| <code>Value</code> | <code>Value</code> to be set.   |
| <code>Min</code>   | Minimum value.  |
| <code>Max</code>   | Maximum value.  |
| <code>Shift</code> | If > 0 it specifies the position of the decimal point.                  |
| <code>Flags</code> | See <i>EDIT flags</i> on page 1217 for a full list of permitted values. |

### 6.2.8.5.1.35 EDIT\_SetDefaultBkColor()

#### Description

Sets the default background color used for EDIT widgets.

#### Prototype

```
void EDIT_SetDefaultBkColor(unsigned int Index,  
                           GUI_COLOR   Color);
```

#### Parameters

| Parameter | Description                   |
|-----------|-------------------------------|
| Index     | Color index. See table below. |
| Color     | Color to be used.             |



### 6.2.8.5.1.36 EDIT\_SetDefaultFont()

#### Description

Sets the default font used for EDIT widgets.

#### Prototype

```
void EDIT_SetDefaultFont(const GUI_FONT * pFont);
```

#### Parameters

| Parameter          | Description                               |
|--------------------|---|
| <code>pFont</code> | Pointer to the font to be set as default. |

### 6.2.8.5.1.37 EDIT\_SetDefaultTextAlign()

#### Description

Sets the default text alignment for EDIT widgets.

#### Prototype

```
void EDIT_SetDefaultTextAlign(int Align);
```

#### Parameters

| Parameter             | Description  |
|-----------------------|--|
| <a href="#">Align</a> | Default text alignment. For details, refer to <code>EDIT_SetTextAlign()</code> . |

### 6.2.8.5.1.38 EDIT\_SetDefaultTextColor()

#### Description

Sets the default text color used for EDIT widgets.

#### Prototype

```
void EDIT_SetDefaultTextColor(unsigned int Index,  
                             GUI_COLOR   Color);
```

#### Parameters

| Parameter          | Description                           |
|--------------------|---------------------------------------|
| <code>Index</code> | Has to be 0, reserved for future use. |
| <code>Color</code> | <code>Color</code> to be used.        |

### 6.2.8.5.1.39 EDIT\_SetFloatMode()

#### Description

Enables the floating point edit mode of the EDIT widget. The given value can be modified in the given range.

#### Prototype

```
void EDIT_SetFloatMode(EDIT_Handle hEdit,
                      float      Value,
                      float      Min,
                      float      Max,
                      int        Shift,
                      U8         Flags);
```

#### Parameters

| Parameter          | Description   |
|--------------------|---|
| <code>hObj</code>  | Handle of EDIT widget.  |
| <code>Value</code> | <code>Value</code> to be modified.                                      |
| <code>Min</code>   | Minimum value.  |
| <code>Max</code>   | Maximum value.  |
| <code>Shift</code> | Number of post decimal positions.                                       |
| <code>Flags</code> | See <i>EDIT flags</i> on page 1217 for a full list of permitted values. |

#### Additional information

The float calculation of the EDIT widget is based on 32 bit signed integer calculation. If using 4 decimal places, the values have to be internally multiplied with  $10^4$ . That exceeds the range of  $2^{31}$ . Editing values with 9 digits (before and after decimal point) will work.

#### 6.2.8.5.1.40 EDIT\_SetFloatValue()

##### Description

The function can be used to set the floating point value of the EDIT widget if working in floating point mode.

##### Prototype

```
void EDIT_SetFloatValue(EDIT_Handle hObj,  
                        float Value);
```

##### Parameters

| Parameter          | Description                                  |
|--------------------|--|
| <code>hObj</code>  | Handle of EDIT widget.                       |
| <code>Value</code> | New floating point value of the EDIT widget. |

##### Additional information

The use of this function makes only sense if the EDIT widget works in floating point mode. If working in text mode the function has no effect. If working in binary, decimal or hexadecimal mode the behavior of the EDIT widget is undefined.

### 6.2.8.5.1.41 EDIT\_SetFocusable()

#### Description

Sets the focusability of the EDIT widget.

#### Prototype

```
void EDIT_SetFocusable(EDIT_Handle hObj,  
                      int          State);
```

| Parameter          | Description  |
|--------------------|--|
| <code>hObj</code>  | Handle of EDIT widget.   |
| <code>State</code> | If State is set to 0, the EDIT widget is set not to be focusable. Otherwise it is set to be focusable. |

### 6.2.8.5.1.42 EDIT\_SetFont()

#### Description

Sets the used font of the EDIT widget.

#### Prototype

```
void EDIT_SetFont(      EDIT_Handle  hObj,  
                    const GUI_FONT  * pFont);
```

#### Parameters

| Parameter          | Description            |
|--------------------|------------------------|
| <code>hObj</code>  | Handle of EDIT widget. |
| <code>pFont</code> | Pointer to the font.   |

### 6.2.8.5.1.43 EDIT\_SetHexMode()

#### Description

Enables the hexadecimal edit mode of the EDIT widget. The given value can be modified in the given range.

#### Prototype

```
void EDIT_SetHexMode(EDIT_Handle hEdit,  
                    U32          Value,  
                    U32          Min,  
                    U32          Max);
```

#### Parameters

| Parameter             | Description                           |
|-----------------------|---------------------------------------|
| <a href="#">hObj</a>  | Handle of EDIT widget.                |
| <a href="#">Value</a> | <a href="#">Value</a> to be modified. |
| <a href="#">Min</a>   | Minimum value.                        |
| <a href="#">Max</a>   | Maximum value.                        |



#### 6.2.8.5.1.44 EDIT\_SetInsertMode()

##### Description

Enables or disables the insert mode of the EDIT widget.

##### Prototype

```
int EDIT_SetInsertMode(EDIT_Handle hObj,  
                      int          OnOff);
```

##### Parameters

| Parameter          | Description  |
|--------------------|--|
| <code>hObj</code>  | Handle of EDIT widget.                                   |
| <code>OnOff</code> | 0 for disabling insert mode, 1 for enabling insert mode. |

##### Return value

Returns the previous insert mode state.

##### Additional information

The use of this function makes only sense if the EDIT widget operates in text mode or in any user defined mode. If working in hexadecimal, binary, floating point or decimal mode the use of this function has no effect except that it changes the appearance of the cursor.

### 6.2.8.5.1.45 EDIT\_SetMaxLen()

#### Description

Sets the maximum number of characters to be edited by the given EDIT widget.

#### Prototype

```
void EDIT_SetMaxLen(EDIT_Handle hObj,  
                   int         MaxLen);
```

#### Parameters

| Parameter              | Description            |
|------------------------|------------------------|
| <a href="#">hObj</a>   | Handle of EDIT widget. |
| <a href="#">MaxLen</a> | Number of characters.  |

### 6.2.8.5.1.46 EDIT\_SetpfAddKeyEx()

#### Description

Sets the function pointer which is used by the EDIT widget to call the function which is responsible for adding characters.

#### Prototype

```
void EDIT_SetpfAddKeyEx(EDIT_Handle    hObj,  
                       tEDIT_AddKeyEx * pfAddKeyEx);
```

#### Parameters

| Parameter                  | Description   |
|----------------------------|---|
| <a href="#">hObj</a>       | Handle of EDIT widget.  |
| <a href="#">pfAddKeyEx</a> | Function pointer to the function to be used to add a character. |

#### Additional information

If working in text mode (default) or one of the modes for editing values, the EDIT widget uses its own routines to add a character. The use of this function only makes sense if the default behavior of the EDIT widget needs to be changed. If a function pointer has been set with this function the application program is responsible for the content of the text buffer.

### 6.2.8.5.1.47 EDIT\_SetSel()

| Before  | After  |
|---|--|
|  |  |

#### Description

Used to set the current selection of the EDIT widget.

#### Prototype

```
void EDIT_SetSel(EDIT_Handle hObj,
                int          FirstChar,
                int          LastChar);
```

#### Parameters

| Parameter              | Description   |
|------------------------|---|
| <code>hObj</code>      | Handle of EDIT widget.  |
| <code>FirstChar</code> | Zero based index of the first character to be selected. -1 if no character should be selected.  |
| <code>LastChar</code>  | Zero based index of the last character to be selected. -1 if all characters from the first character until the last character should be selected. |

#### Additional information

Selected characters are usually displayed in reverse. Setting the cursor position deselects all characters.

#### Example

```
EDIT_SetSel(hEdit, 0, -1); // Selects all characters of the widget
EDIT_SetSel(hEdit, -1, 0); // Deselects all characters
EDIT_SetSel(hEdit, 0, 2); // Selects the first 3 characters
```

### 6.2.8.5.1.48 EDIT\_SetText()

#### Description

Sets the text to be displayed in the EDIT widget.

#### Prototype

```
void EDIT_SetText(      EDIT_Handle  hObj,  
                    const char    * s);
```

#### Parameters

| Parameter         | Description            |
|-------------------|------------------------|
| <code>hObj</code> | Handle of EDIT widget. |
| <code>s</code>    | Text to display.       |

### 6.2.8.5.1.49 EDIT\_SetTextAlign()

#### Description

Sets the text alignment of the EDIT widget.

#### Prototype

```
void EDIT_SetTextAlign(EDIT_Handle hObj,  
                      int          Align);
```

#### Parameters

| Parameter          | Description   |
|--------------------|---|
| <code>hObj</code>  | Handle of EDIT widget.  |
| <code>Align</code> | Or-combination of text alignment flags. List of flags can be found under <i>Text alignment flags</i> on page 252. |

### 6.2.8.5.1.50 EDIT\_SetTextColor()

#### Description

Sets the text color of the EDIT widget.

#### Prototype

```
void EDIT_SetTextColor(EDIT_Handle hObj,  
                      unsigned int Index,  
                      GUI_COLOR   Color);
```

#### Parameters

| Parameter             | Description   |
|-----------------------|---|
| <a href="#">hObj</a>  | Handle of EDIT widget.  |
| <a href="#">Index</a> | <a href="#">Index</a> for text color. See <i>EDIT color indexes</i> on page 1216 for a full list of permitted values. |
| <a href="#">Color</a> | <a href="#">Color</a> to be set.  |

### 6.2.8.5.1.51 EDIT\_SetTextMode()

#### Description

Sets the edit mode of the EDIT widget back to text mode.

#### Prototype

```
void EDIT_SetTextMode(EDIT_Handle hEdit);
```

#### Parameters

| Parameter            | Description            |
|----------------------|------------------------|
| <a href="#">hObj</a> | Handle of EDIT widget. |

#### Additional information

If one of the functions `EDIT_SetBinMode()`, `EDIT_SetDecMode()`, `EDIT_SetFloatMode()` or `EDIT_SetHexMode()` has been used to set the EDIT widget to one of the numeric edit modes, this function sets the edit mode back to text mode. It also clears the content of the EDIT widget.



### 6.2.8.5.1.52 EDIT\_SetValue()

#### Description

Sets the current value of the EDIT widget. Only useful if binary, decimal or hexadecimal edit mode is set.

#### Prototype

```
void EDIT_SetValue(EDIT_Handle hObj,  
                  I32          Value);
```

#### Parameters

| Parameter             | Description            |
|-----------------------|------------------------|
| <a href="#">hObj</a>  | Handle of EDIT widget. |
| <a href="#">Value</a> | New value.             |

### 6.2.8.5.1.53 EDIT\_SetUlongMode()

#### Description

Enables the unsigned long decimal edit mode of the EDIT widget. The given value can be modified in the given range.

#### Prototype

```
void EDIT_SetUlongMode(EDIT_Handle hEdit,  
                       U32         Value,  
                       U32         Min,  
                       U32         Max);
```

#### Parameters

| Parameter             | Description                           |
|-----------------------|---------------------------------------|
| <a href="#">hObj</a>  | Handle of EDIT widget.                |
| <a href="#">Value</a> | <a href="#">Value</a> to be modified. |
| <a href="#">Min</a>   | Minimum value.                        |
| <a href="#">Max</a>   | Maximum value.                        |

#### 6.2.8.5.1.54 EDIT\_SetUserData()

##### Description

Prototype explained at the beginning of the chapter as `<WIDGET>_SetUserData()` on page 995.

## 6.2.8.5.2 Defines

### 6.2.8.5.2.1 EDIT color indexes

#### Description

Color indexes for EDIT widget.

#### Definition

```
#define EDIT_CI_DISABLED    0
#define EDIT_CI_ENABLED    1
#define EDIT_CI_CURSOR     2
```

#### Symbols

| Definition                       | Description   |
|----------------------------------|---|
| <a href="#">EDIT_CI_DISABLED</a> | Color index for the disabled state.   |
| <a href="#">EDIT_CI_ENABLED</a>  | Color index for the enabled state.  |
| <a href="#">EDIT_CI_CURSOR</a>   | Color to be used for the cursor. This is only taken into account if the cursor is not in inversion mode ( <code>EDIT_EnableInversion(0)</code> ). |

### 6.2.8.5.2.2 EDIT flags

#### Description

These flags are used if the EDIT widget is in decimal or float mode. This can be activated by calling `EDIT_SetDecMode()` or `EDIT_SetFloatMode()`. These flags are OR-combinable.

#### Definition

```
#define GUI_EDIT_NORMAL          (0 << 0)
#define GUI_EDIT_SIGNED         (1 << 0)
#define GUI_EDIT_SUPPRESS_LEADING_ZEROES (1 << 1)
```

#### Symbols

| Definition                                    | Description   |
|---|---|
| <code>GUI_EDIT_NORMAL</code>                  | Edit in normal mode. A sign is displayed only if the value is negative. |
| <code>GUI_EDIT_SIGNED</code>                  | "+" and "-" sign is displayed.  |
| <code>GUI_EDIT_SUPPRESS_LEADING_ZEROES</code> | Does not show leading zeroes.   |

### 6.2.8.6 Examples

The `Sample` folder contains the following examples which show how the widget can be used:

- `WIDGET_Edit.c`
- `WIDGET_EditWinmode.c`

Note that several other examples also make use of this widget and may also be helpful to get familiar with the widget.

#### Screenshot of `WIDGET_Edit.c`:



#### Screenshot of `WIDGET_EditWinmode.c`:



## 6.2.9 FRAMEWIN: Frame window widget



FRAMEWIN widgets give your application a PC application-window appearance. They consist of a surrounding frame, a title bar and a user area. The color of the title bar changes to show whether the window is active or inactive, as seen below:

| Active frame window   | Inactive frame window   |
|---|---|
|  |  |

### Note

All FRAMEWIN-related routines are located in the file(s) `FRAMEWIN*.c`, `FRAMEWIN.h`. All identifiers are prefixed `FRAMEWIN`.

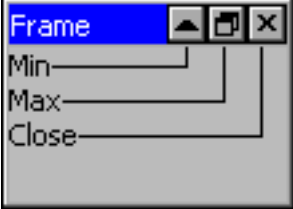
You can attach predefined buttons to the title bar as seen below or you can attach your own buttons to a title bar:

| Description   | Frame window   |
|---|--|
| Frame window with minimize-, maximize- and close button.                    |   |
| Frame window with minimize-, maximize- and close button in maximized state. |  |
| Frame window with minimize-, maximize- and close button in minimized state  |  |

### Skinning...

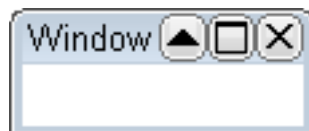

...is available for this widget. The screenshot above shows the widget using the default skin. Details can be found in the chapter *Skinning* on page 2509.

### 6.2.9.1 Structure of the frame window

The following diagram shows the detailed structure and looks of a frame window:

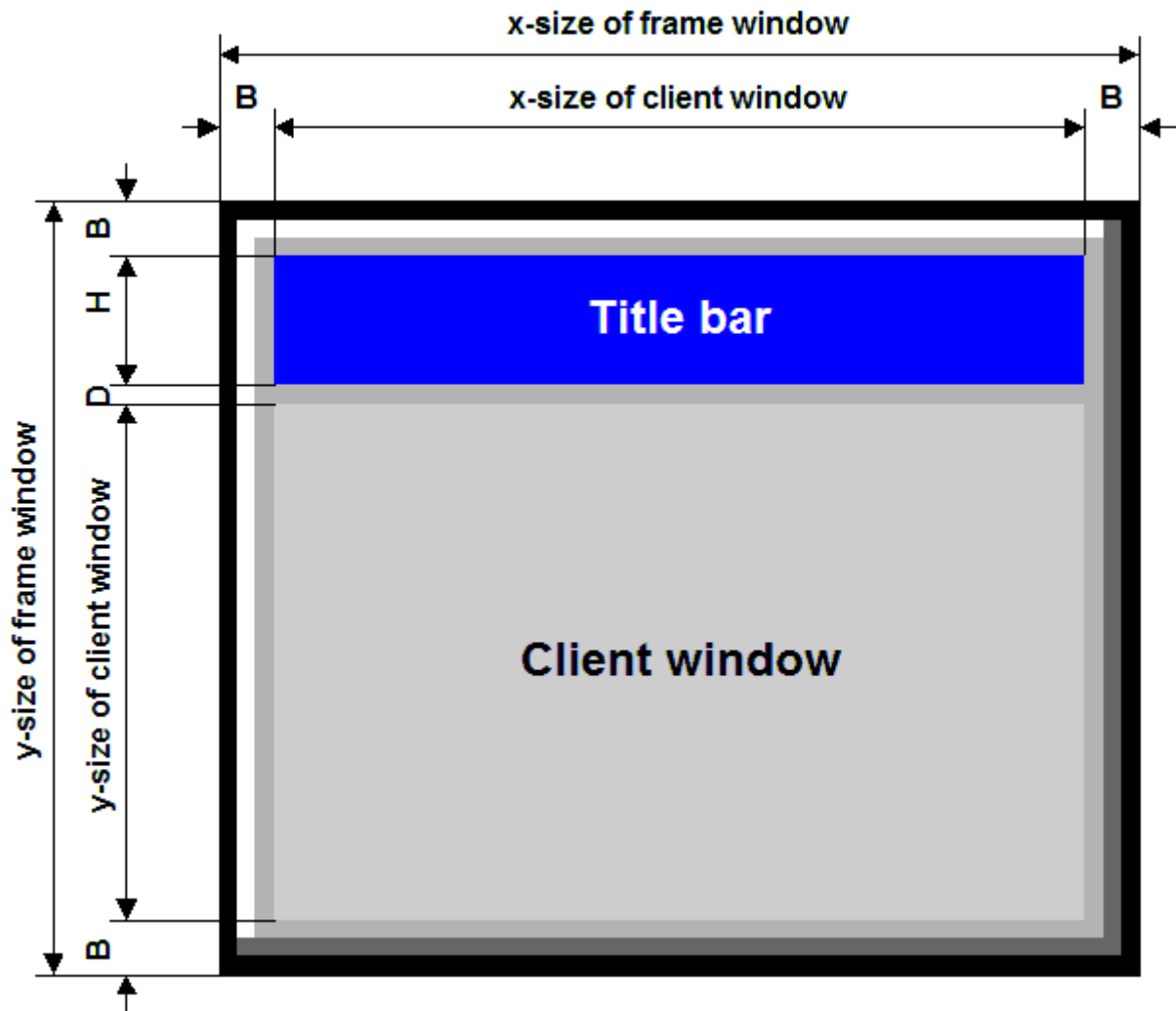

The frame window actually consists of 2 windows; the main window and a child window. The child window is called `Client window`. It is important to be aware of this when dealing with callback functions: There are 2 windows with 2 different callback functions. When creating child windows, these child windows are typically created as children of the client window; their parent is therefor the client window.

| Detail                     | Description   |
|----------------------------|---|
| <code>B</code>             | Border size of the frame window. The default size of the border is 3 pixels.          |
| <code>H</code>             | Height of the title bar. Depends on the size of the used font for the title.          |
| <code>D</code>             | Spacing between title bar and client window. (1 pixel)                                |
| <code>Title bar</code>     | The title bar is part of the frame window and not a separate window.                  |
| <code>Client window</code> | The client window is a separate window created as a child window of the frame window. |



### 6.2.9.2 Configuration options

| Type | Macro   | Default                       | Description  |
|------|---|-------------------------------|--|
| B    | FRAMEWIN_ALLOW_DRAG_ON_FRAME  | 1                             | Allows dragging the widget on the surrounding frame. |
| N    | FRAMEWIN_BARCOLOR_ACTIVE_DEFAULT  | 0xff0000                      | Title bar background color, active state.            |
| N    | FRAMEWIN_BARCOLOR_INACTIVE_DEFAULT  | 0x404040                      | Title bar background color, inactive state.          |
| N    | FRAMEWIN_BORDER_DEFAULT   | 3                             | Outer border width, in pixels.                       |
| N    | FRAMEWIN_CLIENTCOLOR_DEFAULT<br>(with WIDGET_USE_FLEX_SKIN = 0)<br>(with WIDGET_USE_FLEX_SKIN = 1)        | 0xc0c0c0<br>GUI_WHITE         | Color of client window area.                         |
| S    | FRAMEWIN_DEFAULT_FONT<br>(with WIDGET_USE_FLEX_SKIN = 0)<br>(with WIDGET_USE_FLEX_SKIN = 1)               | &GUI_Font8_1<br>&GUI_Font13_1 | Font used for title bar text.                        |
| N    | FRAMEWIN_FRAMECOLOR_DEFAULT   | 0xaaaaaa                      | Frame color.   |
| N    | FRAMEWIN_IBORDER_DEFAULT  | 1                             | Inner border width, in pixels.                       |
| N    | FRAMEWIN_TEXTCOLOR_ACTIVE_DEFAULT<br>(with WIDGET_USE_FLEX_SKIN = 0)<br>(with WIDGET_USE_FLEX_SKIN = 1)   | GUI_WHITE<br>GUI_BLACK        | Title bar text color, active state.                  |
| N    | FRAMEWIN_TEXTCOLOR_INACTIVE_DEFAULT<br>(with WIDGET_USE_FLEX_SKIN = 0)<br>(with WIDGET_USE_FLEX_SKIN = 1) | GUI_WHITE<br>GUI_BLACK        | Title bar text color, inactive state.                |
| N    | FRAMEWIN_TITLEHEIGHT_DEFAULT  | 0                             | Default height of title bar.                         |

### 6.2.9.3 Keyboard reaction

The widget can not gain the input focus and does not react on keyboard input.

### 6.2.9.4 FRAMEWIN API

The table below lists the available emWin FRAMEWIN-related routines in alphabetical order. Detailed descriptions of the routines follow.

#### Functions

| Routine                                   | Description   |
|---|---|
| <a href="#">FRAMEWIN_AddButton()</a>      | Adds a button to the title bar of the FRAMEWIN widget.          |
| <a href="#">FRAMEWIN_AddCloseButton()</a> | Adds a close button to the title bar of the FRAMEWIN widget.    |
| <a href="#">FRAMEWIN_AddMaxButton()</a>   | Adds a maximize button to the title bar of the FRAMEWIN widget. |
| <a href="#">FRAMEWIN_AddMenu()</a>        | Adds the given menu to a FRAMEWIN widget.                       |
| <a href="#">FRAMEWIN_AddMinButton()</a>   | Adds a minimize button to the title bar of the FRAMEWIN widget. |
| <a href="#">FRAMEWIN_Create()</a>         | Creates a FRAMEWIN widget. (Obsolete)                           |
| <a href="#">FRAMEWIN_CreateAsChild()</a>  | Creates a FRAMEWIN widget as a child window. (Obsolete)         |

| Routine                                       | Description   |
|---|---|
| <code>FRAMEWIN_CreateEx()</code>              | Creates a FRAMEWIN widget.  |
| <code>FRAMEWIN_CreateIndirect()</code>        | Creates a FRAMEWIN widget from a resource table entry.                          |
| <code>FRAMEWIN_CreateUser()</code>            | Creates a FRAMEWIN widget using extra bytes as user data.                       |
| <code>FRAMEWIN_GetActive()</code>             | Returns if the given FRAMEWIN widget is in active state or not.                 |
| <code>FRAMEWIN_GetBarColor()</code>           | Returns the color of the title bar of the given FRAMEWIN widget.                |
| <code>FRAMEWIN_GetBorderSize()</code>         | Returns the border size of the given FRAMEWIN widget.                           |
| <code>FRAMEWIN_GetDefaultBarColor()</code>    | Returns the default color for title bars in FRAMEWIN widgets.                   |
| <code>FRAMEWIN_GetDefaultBorderSize()</code>  | Returns the default border size of FRAMEWIN widgets.                            |
| <code>FRAMEWIN_GetDefaultClientColor()</code> | Returns the default color of client areas in FRAMEWIN widgets.                  |
| <code>FRAMEWIN_GetDefaultFont()</code>        | Returns the default font used for captions of FRAMEWIN widgets.                 |
| <code>FRAMEWIN_GetDefaultTextColor()</code>   | Returns the default text color of the title.                                    |
| <code>FRAMEWIN_GetDefaultTitleHeight()</code> | Returns the default height of title bars in FRAMEWIN widget.                    |
| <code>FRAMEWIN_GetFont()</code>               | Returns a pointer to the font used to draw the title text.                      |
| <code>FRAMEWIN_GetText()</code>               | Returns the title text.   |
| <code>FRAMEWIN_GetTextAlign()</code>          | Returns the text alignment of the title text.                                   |
| <code>FRAMEWIN_GetTitleHeight()</code>        | Returns the height of title bar of the given FRAMEWIN widget.                   |
| <code>FRAMEWIN_GetUserData()</code>           | Retrieves the data set with <code>FRAMEWIN_SetUserData()</code> .               |
| <code>FRAMEWIN_IsMinimized()</code>           | Returns if the FRAMEWIN widget is minimized or not.                             |
| <code>FRAMEWIN_IsMaximized()</code>           | Returns if the FRAMEWIN widget is maximized or not.                             |
| <code>FRAMEWIN_Maximize()</code>              | Enlarges a FRAMEWIN widget to the size of its parent window.                    |
| <code>FRAMEWIN_Minimize()</code>              | Hides the client area of the given FRAMEWIN widget.                             |
| <code>FRAMEWIN_OwnerDraw()</code>             | Default function for drawing the title bar of a FRAMEWIN widget.                |
| <code>FRAMEWIN_Restore()</code>               | Restores a minimized or maximized FRAMEWIN widget to its old size and position. |
| <code>FRAMEWIN_SetActive()</code>             | Sets the state of a specified FRAMEWIN widget.                                  |
| <code>FRAMEWIN_SetBarColor()</code>           | Sets the color of the title bar of a specified FRAMEWIN widget.                 |
| <code>FRAMEWIN_SetBorderSize()</code>         | Sets the border size of a specified FRAMEWIN widget.                            |

| Routine                                       | Description  |
|---|--|
| <code>FRAMEWIN_SetClientColor()</code>        | Sets the color of the client window area of a specified FRAMEWIN widget. |
| <code>FRAMEWIN_SetDefaultBarColor()</code>    | Sets the default color for title bars in FRAMEWIN widgets.               |
| <code>FRAMEWIN_SetDefaultBorderSize()</code>  | Sets the default border size of FRAMEWIN widgets.                        |
| <code>FRAMEWIN_SetDefaultClientColor()</code> | Sets the default color for client areas in FRAMEWIN widgets.             |
| <code>FRAMEWIN_SetDefaultFont()</code>        | Sets the default font used to display the title in FRAMEWIN widgets.     |
| <code>FRAMEWIN_SetDefaultTextColor()</code>   | Sets the default text color of the title.                                |
| <code>FRAMEWIN_SetDefaultTitleHeight()</code> | Sets the size in Y for the title bar.                                    |
| <code>FRAMEWIN_SetFont()</code>               | Sets the title font of the FRAMEWIN widget.                              |
| <code>FRAMEWIN_SetMoveable()</code>           | Sets a FRAMEWIN widget to a moveable or fixed state.                     |
| <code>FRAMEWIN_SetOwnerDraw()</code>          | Enables the FRAMEWIN widget to be owner drawn.                           |
| <code>FRAMEWIN_SetResizable()</code>          | Sets the resizable state of the given FRAMEWIN widget.                   |
| <code>FRAMEWIN_SetText()</code>               | Sets the title text.   |
| <code>FRAMEWIN_SetTextAlign()</code>          | Sets the text alignment of the title bar.                                |
| <code>FRAMEWIN_SetTextColor()</code>          | Sets the color of the title text for both states, active and inactive.   |
| <code>FRAMEWIN_SetTextColorEx()</code>        | Sets the text color for the given state.                                 |
| <code>FRAMEWIN_SetTitleHeight()</code>        | Sets the height of the title bar.  |
| <code>FRAMEWIN_SetTitleVis()</code>           | Sets the visibility flag of the title bar.                               |
| <code>FRAMEWIN_SetUserData()</code>           | Sets the extra data of a FRAMEWIN widget.                                |

## Defines

| Group of defines                   | Description   |
|------------------------------------|---|
| <code>FRAMEWIN</code> button flags | Determine on which side of the FRAMEWIN a button should be added. |
| <code>FRAMEWIN</code> create flags | Create flags that define the behavior of the FRAMEWIN widget.     |
| <code>FRAMEWIN</code> states       | State of the FRAMEWIN used for various functions.                 |

## 6.2.9.4.1 Functions

### 6.2.9.4.1.1 FRAMEWIN\_AddButton()

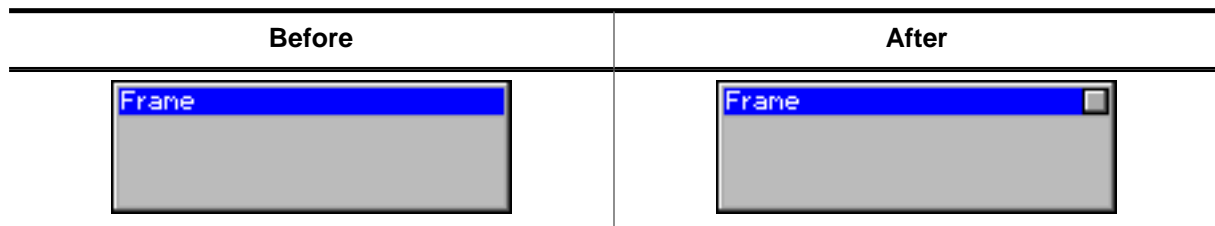

#### Description

Adds a button to the title bar of the FRAMEWIN widget.

#### Prototype

```
WM_HWIN FRAMEWIN_AddButton(FRAMEWIN_Handle hObj,
                             int             Flags,
                             int             Off,
                             int             Id);
```

#### Parameters

| Parameter          | Description  |
|--------------------|--|
| <code>hObj</code>  | Handle of FRAMEWIN widget.   |
| <code>Flags</code> | See <i>FRAMEWIN button flags</i> on page 1276 for a full list of permitted values. |
| <code>Off</code>   | X-offset used to create the BUTTON widget  |
| <code>Id</code>    | ID of the BUTTON widget  |

#### Return value

Handle of the BUTTON widget.

#### Additional information

The button will be created as a child window from the FRAMEWIN widget. So the Window Manager keeps sure it will be deleted when the FRAMEWIN widget will be deleted.

The button can be created at the left side or at the right side of the title bar depending on the parameter `Flags`. The parameter `Offset` specifies the space between the button and the border of the FRAMEWIN widget or the space between the previous created button.

### 6.2.9.4.1.2 FRAMEWIN\_AddCloseButton()

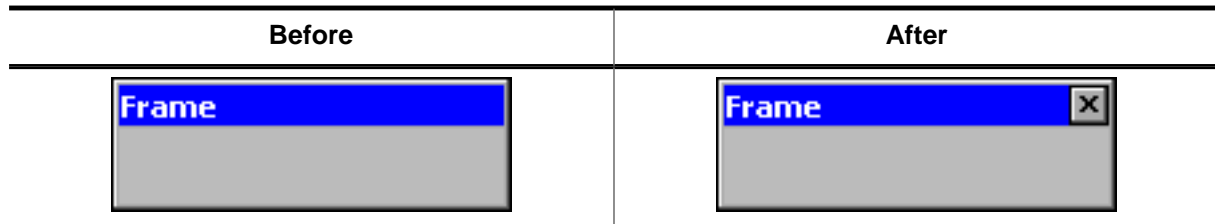

#### Description

Adds a close button to the title bar of the FRAMEWIN widget.

#### Prototype

```
WM_HWIN FRAMEWIN_AddCloseButton(FRAMEWIN_Handle hObj,
                                int               Flags,
                                int               Off);
```

#### Parameters

| Parameter          | Description  |
|--------------------|--|
| <code>hObj</code>  | Handle of FRAMEWIN widget.   |
| <code>Flags</code> | See <i>FRAMEWIN button flags</i> on page 1276 for a full list of permitted values. |
| <code>Off</code>   | X-offset used to create the BUTTON widget  |

#### Return value

Handle of the close button.

#### Additional information

When the user presses the close button the frame window and all its children will be deleted.

### 6.2.9.4.1.3 FRAMEWIN\_AddMaxButton()

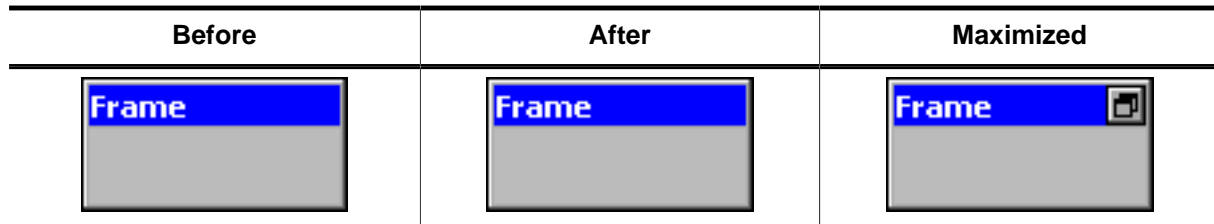

#### Description

Adds a maximize button to the title bar of the FRAMEWIN widget.

#### Prototype

```
WM_HWIN FRAMEWIN_AddMaxButton(FRAMEWIN_Handle hObj,
                               int             Flags,
                               int             Off);
```

#### Parameters

| Parameter          | Description  |
|--------------------|--|
| <code>hObj</code>  | Handle of FRAMEWIN widget.   |
| <code>Flags</code> | See <i>FRAMEWIN button flags</i> on page 1276 for a full list of permitted values. |
| <code>Off</code>   | X-offset used to create the BUTTON widget  |

#### Return value

Handle of the maximize button.

#### Additional information

When the user presses the maximize button the first time the FRAMEWIN widget will be enlarged to the size of its parent window. The second use of the button will reduce the frame window to its old size and restores the old position.

### 6.2.9.4.1.4 FRAMEWIN\_AddMenu()

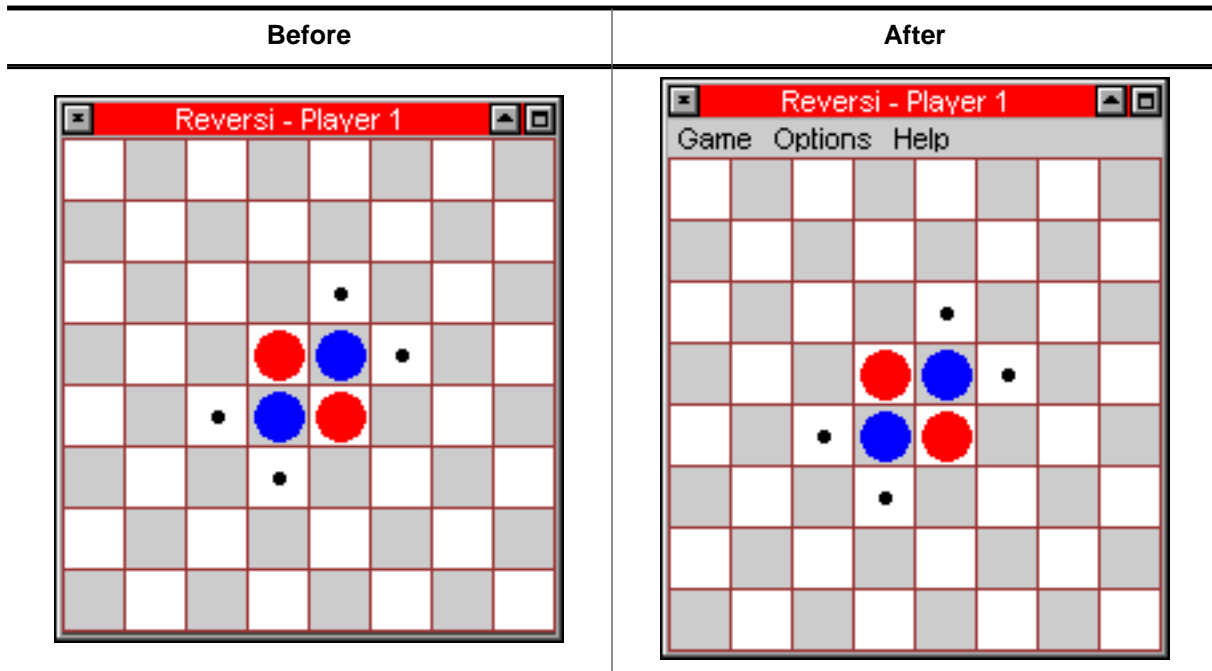

#### Description

Adds the given menu to a FRAMEWIN widget. The menu is shown below the title bar.

#### Prototype

```
void FRAMEWIN_AddMenu(FRAMEWIN_Handle hObj,
                      WM_HWIN        hMenu);
```

#### Parameters

| Parameter             | Description                        |
|-----------------------|------------------------------------|
| <a href="#">hObj</a>  | Handle of frame window.            |
| <a href="#">hMenu</a> | Handle of MENU widget to be added. |

#### Return value

Handle of the maximize button.

#### Additional information

The added MENU is attached as a child of the FRAMEWIN widget. If the FRAMEWIN widget has been created with a callback routine, the function makes sure, that the WM\_MENU messages are passed to the client window of the FRAMEWIN widget.

### 6.2.9.4.1.5 FRAMEWIN\_AddMinButton()

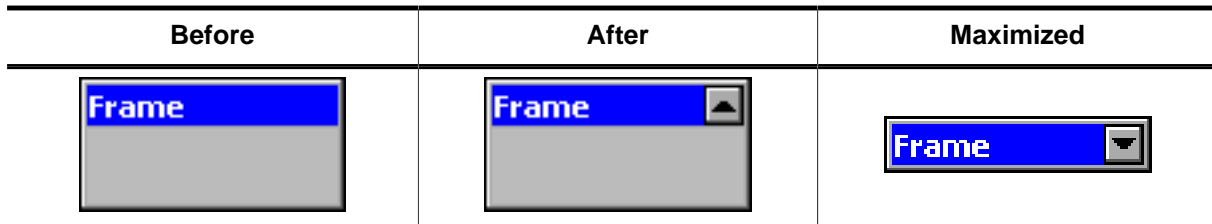

#### Description

Adds a minimize button to the title bar of the FRAMEWIN widget.

#### Prototype

```
WM_HWIN FRAMEWIN_AddMinButton(FRAMEWIN_Handle hObj,
                               int             Flags,
                               int             Off);
```

#### Parameters

| Parameter          | Description  |
|--------------------|--|
| <code>hObj</code>  | Handle of FRAMEWIN widget.   |
| <code>Flags</code> | See <i>FRAMEWIN button flags</i> on page 1276 for a full list of permitted values. |
| <code>Off</code>   | X-offset used to create the BUTTON widget  |

#### Return value

Handle of the minimize button.

#### Additional information

When the user presses the minimize button the first time the client area of the FRAMEWIN widget will be hidden and only the title bar remains visible. The second use of the button will restore the FRAMEWIN widget to its old size.



### 6.2.9.4.1.6 FRAMEWIN\_Create()

#### Note

This function is **deprecated**, `FRAMEWIN_CreateEx()` should be used instead.

#### Description

Creates a FRAMEWIN widget of a specified size at a specified location.

#### Prototype

```
FRAMEWIN_Handle FRAMEWIN_Create(const char      * pText,
                                WM_CALLBACK * cb,
                                int           Flags,
                                int           x0,
                                int           y0,
                                int           xSize,
                                int           ySize);
```

#### Parameters

| Parameter           | Description  |
|---------------------|--|
| <code>pTitle</code> | Title displayed in the title bar.  |
| <code>cb</code>     | Pointer to callback routine of client area.  |
| <code>Flags</code>  | Window create flags. Typically <code>WM_CF_SHOW</code> in order to make the widget visible immediately (refer to <i>Window create flags</i> on page 977 for a list of available parameter values). |
| <code>x0</code>     | Leftmost pixel of the frame window (in parent coordinates).  |
| <code>y0</code>     | Topmost pixel of the frame window (in parent coordinates).   |
| <code>xSize</code>  | Horizontal size of the frame window (in pixels).   |
| <code>ySize</code>  | Vertical size of the frame window (in pixels).   |

#### Return value

Handle of the created FRAMEWIN widget; 0 if the function fails.

### 6.2.9.4.1.7 FRAMEWIN\_CreateAsChild()

#### Note

This function is **deprecated**, `FRAMEWIN_CreateEx()` should be used instead.

#### Description

Creates a FRAMEWIN widget as a child window.

#### Prototype

```
FRAMEWIN_Handle FRAMEWIN_CreateAsChild(    int           x0,
                                           int           y0,
                                           int           xSize,
                                           int           ySize,
                                           WM_HWIN      hParent,
                                           const char    * pText,
                                           WM_CALLBACK * cb,
                                           int           Flags);
```

#### Parameters

| Parameter            | Description   |
|----------------------|---|
| <code>x0</code>      | X-position of the FRAMEWIN widget relative to the parent window.      |
| <code>y0</code>      | Y-position of the FRAMEWIN widget relative to the parent window.      |
| <code>xSize</code>   | Horizontal size of the FRAMEWIN widget (in pixels).                   |
| <code>ySize</code>   | Vertical size of the FRAMEWIN widget (in pixels).                     |
| <code>hParent</code> | Handle of parent window.  |
| <code>pText</code>   | Text to be displayed in the title bar.                                |
| <code>cb</code>      | Optional pointer to a custom callback function for the client window. |
| <code>Flags</code>   | Window create flags (see <i>Window create flags</i> on page 977).     |

#### Return value

Handle of the created FRAMEWIN widget; 0 if the function fails.

### 6.2.9.4.1.8 FRAMEWIN\_CreateEx()

#### Description

Creates a FRAMEWIN widget of a specified size at a specified location.

#### Prototype

```
FRAMEWIN_Handle FRAMEWIN_CreateEx(    int        x0,
                                       int        y0,
                                       int        xSize,
                                       int        ySize,
                                       WM_HWIN    hParent,
                                       int        WinFlags,
                                       int        ExFlags,
                                       int        Id,
                                       const char * pTitle,
                                       WM_CALLBACK * cb);
```

#### Parameters

| Parameter             | Description  |
|-----------------------|--|
| <code>x0</code>       | Leftmost pixel of the FRAMEWIN widget (in parent coordinates).   |
| <code>y0</code>       | Topmost pixel of the FRAMEWIN widget (in parent coordinates).  |
| <code>xSize</code>    | Horizontal size of the FRAMEWIN widget (in pixels).  |
| <code>ySize</code>    | Vertical size of the FRAMEWIN widget (in pixels).  |
| <code>hParent</code>  | Handle of parent window. If 0, the new FRAMEWIN widget will be a child of the desktop (top-level window).  |
| <code>WinFlags</code> | Window create flags. Typically <code>WM_CF_SHOW</code> in order to make the widget visible immediately (refer to <i>Window create flags</i> on page 977 for a list of available parameter values). |
| <code>ExFlags</code>  | See <i>FRAMEWIN create flags</i> on page 1277.   |
| <code>Id</code>       | Window ID of the FRAMEWIN widget.  |
| <code>pTitle</code>   | Title displayed in the title bar.  |
| <code>cb</code>       | Optional pointer to a custom callback function for the client window.  |

#### Return value

Handle of the created FRAMEWIN widget; 0 if the function fails.

#### Additional information

The user callback routine is typically used for 2 purposes:

- to paint the client window (if filling with a color is not desired)
- to react to messages of child windows, typically dialog elements The normal behaviour of the client window is to paint itself, filling the entire window with the client color. If the user callback also fills the client window (or a part of it), it can be desirable to set the client color to `GUI_INVALID_COLOR`, causing the window callback not to fill the client window.

The user callback of the client window does not receive all messages sent to the client window; some system messages are completely handled by the window callback routine and are not passed to the user callback. All notification messages as well as `WM_PAINT` and all user messages are sent to the user callback routine. The handle received by the user callback is the handle of the frame window (the parent window of the client window), except for the `WM_PAINT` message, which receives the handle of the client window.

### 6.2.9.4.1.9 FRAMEWIN\_CreateIndirect()

#### Description

The prototype of this function is explained at the beginning of this chapter. Details can be found in the description of the function `<WIDGET>_CreateIndirect()` on page 992. The element `Para` of the according `GUI_WIDGET_CREATE_INFO` structure is not used. The element `Flags` is used according to the parameter `ExFlags` of the function `FRAMEWIN_CreateEx()`.

#### 6.2.9.4.1.10 FRAMEWIN\_CreateUser()

##### Description

Prototype explained at the beginning of the chapter as `<WIDGET>_CreateUser()` on page 993. For a detailed description of the parameters the function `FRAMEWIN_CreateEx()` can be referred to.

### 6.2.9.4.1.11 FRAMEWIN\_GetActive()

#### Description

Returns if the given FRAMEWIN widget is in active state or not.

#### Prototype

```
int FRAMEWIN_GetActive(FRAMEWIN_Handle hObj);
```

#### Parameters

| Parameter            | Description                |
|----------------------|----------------------------|
| <a href="#">hObj</a> | Handle of FRAMEWIN widget. |

#### Return value

1 if FRAMEWIN widget is in active state  
0 if not.

### 6.2.9.4.1.12 FRAMEWIN\_GetBarColor()

#### Description

Returns the color of the title bar of the given FRAMEWIN widget.

#### Prototype

```
GUI_COLOR FRAMEWIN_GetBarColor(FRAMEWIN_Handle hObj,  
                                unsigned Index);
```

#### Parameters

| Parameter             | Description  |
|-----------------------|--|
| <a href="#">hObj</a>  | Handle of FRAMEWIN widget.   |
| <a href="#">Index</a> | See <i>FRAMEWIN states</i> on page 1278 for a full list of permitted values. |

#### Return value

Color of the title bar as RGB value.

### 6.2.9.4.1.13 FRAMEWIN\_GetBorderSize()

#### Description

Returns the border size of the given FRAMEWIN widget.

#### Prototype

```
int FRAMEWIN_GetBorderSize(FRAMEWIN_Handle hObj);
```

#### Parameters

| Parameter            | Description                |
|----------------------|----------------------------|
| <a href="#">hObj</a> | Handle of FRAMEWIN widget. |

#### Return value

The border size of the given FRAMEWIN widget.



#### 6.2.9.4.1.14 FRAMEWIN\_GetDefaultBarColor()

##### Description

Returns the default color for title bars in FRAMEWIN widgets.

##### Prototype

```
GUI_COLOR FRAMEWIN_GetDefaultBarColor(unsigned Index);
```

##### Parameters

| Parameter             | Description  |
|-----------------------|--|
| <a href="#">Index</a> | See <i>FRAMEWIN states</i> on page 1278 for a full list of permitted values. |

##### Return value

Pointer to the default title bar color used for FRAMEWIN widgets in the specified state.

#### 6.2.9.4.1.15 FRAMEWIN\_GetDefaultBorderSize()

##### Description

Returns the default border size of FRAMEWIN widgets.

##### Prototype

```
int FRAMEWIN_GetDefaultBorderSize(void);
```

##### Return value

Default border size of FRAMEWIN widgets.

#### 6.2.9.4.1.16 FRAMEWIN\_GetDefaultClientColor()

##### Description

Returns the default color of client areas in FRAMEWIN widgets.

##### Prototype

```
GUI_COLOR FRAMEWIN_GetDefaultClientColor(void);
```

##### Return value

Pointer to the default client area color.

#### 6.2.9.4.1.17 FRAMEWIN\_GetDefaultFont()

##### Description

Returns the default font used for captions of FRAMEWIN widgets.

##### Prototype

```
GUI_FONT *FRAMEWIN_GetDefaultFont(void);
```

##### Return value

Pointer to the default font used for captions of captions widgets.

### 6.2.9.4.1.18 FRAMEWIN\_GetDefaultTextColor()

#### Description

Returns the default text color of the title.

#### Prototype

```
GUI_COLOR FRAMEWIN_GetDefaultTextColor(unsigned Index);
```

#### Parameters

| Parameter             | Description  |
|-----------------------|--|
| <a href="#">Index</a> | See <i>FRAMEWIN</i> states on page 1278 for a full list of permitted values. |

#### Return value

Default text color of the title.

### 6.2.9.4.1.19 FRAMEWIN\_GetDefaultTitleHeight()

#### Description

Returns the default height of title bars in FRAMEWIN widget.

#### Prototype

```
int FRAMEWIN_GetDefaultTitleHeight(void);
```

#### Return value

Default title bar height. For more information about the title height, refer to `FRAMEWIN_SetDefaultTitleHeight()`.

### 6.2.9.4.1.20 FRAMEWIN\_GetFont()

#### Description

Returns a pointer to the font used to draw the title text.

#### Prototype

```
GUI_FONT *FRAMEWIN_GetFont(FRAMEWIN_Handle hObj);
```

#### Parameters

| Parameter            | Description                |
|----------------------|----------------------------|
| <a href="#">hObj</a> | Handle of FRAMEWIN widget. |

#### Return value

Pointer to the font used to draw the title text.

### 6.2.9.4.1.21 FRAMEWIN\_GetText()

#### Description

Returns the title text.

#### Prototype

```
void FRAMEWIN_GetText(FRAMEWIN_Handle hObj,  
                     char * pBuffer,  
                     int MaxLen);
```

#### Parameters

| Parameter               | Description   |
|-------------------------|---|
| <a href="#">hObj</a>    | Handle of FRAMEWIN widget.                          |
| <a href="#">pBuffer</a> | Pointer to buffer to be filled with the title text. |
| <a href="#">MaxLen</a>  | Buffer size in bytes.                               |

#### Additional information

If the buffer size is smaller than the title text the function copies [MaxLen](#) .



### 6.2.9.4.1.22 FRAMEWIN\_GetTextAlign()

#### Description

Returns the text alignment of the title text.

#### Prototype

```
int FRAMEWIN_GetTextAlign(FRAMEWIN_Handle hObj);
```

#### Parameters

| Parameter            | Description                |
|----------------------|----------------------------|
| <a href="#">hObj</a> | Handle of FRAMEWIN widget. |

#### Return value

The currently used text alignment. For details about text alignment, refer to [GUI\\_SetTextAlign\(\)](#).

### 6.2.9.4.1.23 FRAMEWIN\_GetTitleHeight()

#### Description

Returns the height of title bar of the given FRAMEWIN widget.

#### Prototype

```
int FRAMEWIN_GetTitleHeight(FRAMEWIN_Handle hObj);
```

#### Parameters

| Parameter            | Description               |
|----------------------|---------------------------|
| <a href="#">hObj</a> | Handle of FRAMEWIN widget |

#### Return value

The height of title bar of the given FRAMEWIN widget. For more information about the title height, refer to *FRAMEWIN\_SetDefaultTitleHeight* on page 1263.

#### 6.2.9.4.1.24 FRAMEWIN\_GetUserData()

##### Description

Prototype explained at the beginning of the chapter as `<WIDGET>_GetUserData()` on page 994.

### 6.2.9.4.1.25 FRAMEWIN\_IsMinimized()

#### Description

Returns if the FRAMEWIN widget is minimized or not.

#### Prototype

```
int FRAMEWIN_IsMinimized(FRAMEWIN_Handle hObj);
```

#### Parameters

| Parameter            | Description               |
|----------------------|---------------------------|
| <a href="#">hObj</a> | Handle of FRAMEWIN widget |

#### Return value

1 if the FRAMEWIN widget is minimized  
0 if not.

### 6.2.9.4.1.26 FRAMEWIN\_IsMaximized()

#### Description

Returns if the FRAMEWIN widget is maximized or not.

#### Prototype

```
int FRAMEWIN_IsMaximized(FRAMEWIN_Handle hObj);
```

#### Parameters

| Parameter            | Description               |
|----------------------|---------------------------|
| <a href="#">hObj</a> | Handle of FRAMEWIN widget |

#### Return value

1 if the FRAMEWIN widget is maximized  
0 if not.

### 6.2.9.4.1.27 FRAMEWIN\_Maximize()

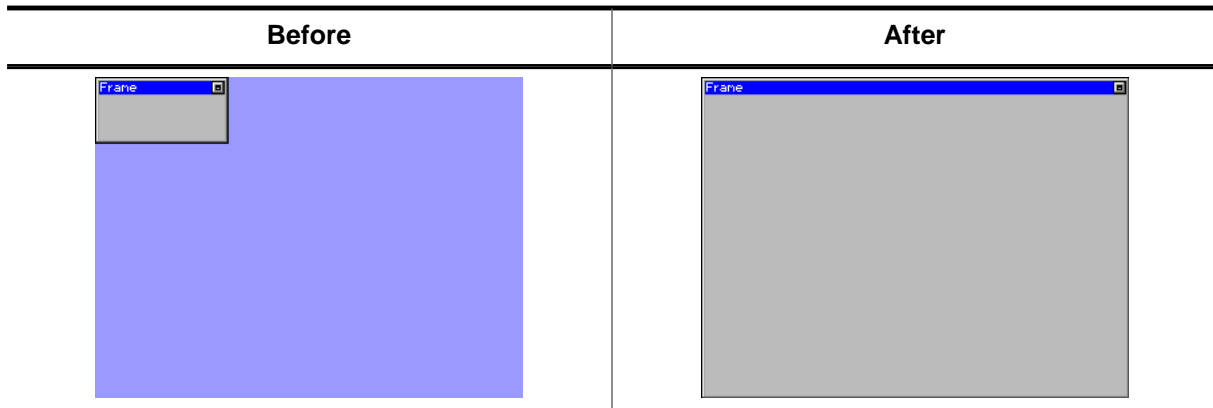

#### Description

Enlarges a FRAMEWIN widget to the size of its parent window.

#### Prototype

```
void FRAMEWIN_Maximize(FRAMEWIN_Handle hObj);
```

#### Parameters

| Parameter | Description               |
|-----------|---------------------------|
| hObj      | Handle of FRAMEWIN widget |

#### Additional information

When calling this function the FRAMEWIN widget will show the same behavior as when the user presses the maximize button. The FRAMEWIN widget will be enlarged to the size of its parent window.

### 6.2.9.4.1.28 FRAMEWIN\_Minimize()



#### Description

Hides the client area of the given FRAMEWIN widget.

#### Prototype

```
void FRAMEWIN_Minimize(FRAMEWIN_Handle hObj);
```

#### Parameters

| Parameter | Description               |
|-----------|---------------------------|
| hObj      | Handle of FRAMEWIN widget |

#### Additional information

When calling this function the FRAMEWIN widget will show the same behavior as when the user presses the minimize button. The FRAMEWIN widget will be enlarged and only the title bar remains visible.

### 6.2.9.4.1.29 FRAMEWIN\_OwnerDraw()

#### Note

OwnerDraw routines for FRAMEWIN widgets are deprecated and only work in conjunction the classic skin.

#### Description

Default function for drawing the title bar of a FRAMEWIN widget.

#### Prototype

```
int FRAMEWIN_OwnerDraw(const WIDGET_ITEM_DRAW_INFO * pDrawItemInfo);
```

#### Parameters

| Parameter                  | Description                                   |
|----------------------------|---|
| <code>pDrawItemInfo</code> | Pointer to a WIDGET_ITEM_DRAW_INFO structure. |

#### Return value

Returns 0.

#### Additional information

This function is useful if `FRAMEWIN_SetOwnerDraw()` is used. It should be called for all unhandled commands passed to the owner draw function. For more information, refer to the section explaining user drawn widgets and `FRAMEWIN_SetOwnerDraw()`.



### 6.2.9.4.1.30 FRAMEWIN\_Restore()



#### Description

Restores a minimized or maximized FRAMEWIN widget to its old size and position.

#### Prototype

```
void FRAMEWIN_Restore(FRAMEWIN_Handle hObj);
```

#### Parameters

| Parameter | Description                |
|-----------|----------------------------|
| hObj      | Handle of FRAMEWIN widget. |

#### Return value

Returns 0.

#### Additional information

If the given FRAMEWIN widget is neither maximized nor minimized the function takes no effect.

### 6.2.9.4.1.31 FRAMEWIN\_SetActive()



#### Description

Sets the state of a specified FRAMEWIN widget. Depending on the state, the color of the title bar will change.

#### Prototype

```
void FRAMEWIN_SetActive(FRAMEWIN_Handle hObj,
                       int State);
```

#### Parameters

| Parameter          | Description  |
|--------------------|--|
| <code>hObj</code>  | Handle of FRAMEWIN widget.   |
| <code>State</code> | See <i>FRAMEWIN states</i> on page 1278 for a full list of permitted values. |

#### Return value

Returns 0.

#### Additional information

This function is obsolete. If pointing with a input device to a child of a FRAMEWIN widget the FRAMEWIN widget will become active automatically. It is not recommended to use this function. If using this function to set a FRAMEWIN widget to active state, it is not warranted that the state becomes inactive if an other FRAMEWIN widget becomes active.

### 6.2.9.4.1.32 FRAMEWIN\_SetBarColor()



#### Description

Sets the color of the title bar of a specified FRAMEWIN widget.

#### Prototype

```
void FRAMEWIN_SetBarColor(FRAMEWIN_Handle hObj,
                          unsigned Index,
                          GUI_COLOR Color);
```

#### Parameters

| Parameter          | Description  |
|--------------------|--|
| <code>hObj</code>  | Handle of FRAMEWIN widget.   |
| <code>Index</code> | See <i>FRAMEWIN states</i> on page 1278 for a full list of permitted values. |
| <code>Color</code> | <code>Color</code> to be set.  |

### 6.2.9.4.1.33 FRAMEWIN\_SetBorderSize()



#### Description

Sets the border size of a specified FRAMEWIN widget.

#### Prototype

```
void FRAMEWIN_SetBorderSize(FRAMEWIN_Handle hObj,
                             unsigned      Size);
```

#### Parameters

| Parameter | Description                             |
|-----------|---|
| hObj      | Handle of FRAMEWIN widget.              |
| Size      | New border size of the FRAMEWIN widget. |

#### Additional information

This function has no effect when using Flex Skin (default).

### 6.2.9.4.1.34 FRAMEWIN\_SetClientColor()



#### Description

Sets the color of the client window area of a specified FRAMEWIN widget.

#### Prototype

```
void FRAMEWIN_SetClientColor(FRAMEWIN_Handle hObj,
                             GUI_COLOR      Color);
```

#### Parameters

| Parameter | Description                |
|-----------|----------------------------|
| hObj      | Handle of FRAMEWIN widget. |
| Color     | Color to be set.           |

### 6.2.9.4.1.35 FRAMEWIN\_SetDefaultBarColor()

#### Description

Sets the default color for title bars in FRAMEWIN widgets.

#### Prototype

```
void FRAMEWIN_SetDefaultBarColor(unsigned Index,  
                                GUI_COLOR Color);
```

#### Parameters

| Parameter             | Description  |
|-----------------------|--|
| <a href="#">Index</a> | See <i>FRAMEWIN states</i> on page 1278 for a full list of permitted values. |
| <a href="#">Color</a> | <a href="#">Color</a> to be set.   |

### 6.2.9.4.1.36 FRAMEWIN\_SetDefaultBorderSize()

#### Description

Sets the default border size of FRAMEWIN widgets.

#### Prototype

```
void FRAMEWIN_SetDefaultBorderSize(int DefaultBorderSize);
```

#### Parameters

| Parameter               | Description     |
|-------------------------|-----------------|
| <code>BorderSize</code> | Size to be set. |

### 6.2.9.4.1.37 FRAMEWIN\_SetDefaultClientColor()

#### Description

Sets the default color for client areas in FRAMEWIN widgets.

#### Prototype

```
void FRAMEWIN_SetDefaultClientColor(GUI_COLOR Color);
```

#### Parameters

| Parameter | Description      |
|-----------|------------------|
| Color     | Color to be set. |



### 6.2.9.4.1.38 FRAMEWIN\_SetDefaultFont()

#### Description

Sets the default font used to display the title in FRAMEWIN widgets.

#### Prototype

```
void FRAMEWIN_SetDefaultFont(const GUI_FONT * pFont);
```

#### Parameters

| Parameter          | Description                            |
|--------------------|--|
| <code>pFont</code> | Pointer to font to be used as default. |

### 6.2.9.4.1.39 FRAMEWIN\_SetDefaultTextColor()

#### Description

Sets the default text color of the title.

#### Prototype

```
void FRAMEWIN_SetDefaultTextColor(unsigned Index,  
                                  GUI_COLOR Color);
```

#### Parameters

| Parameter             | Description  |
|-----------------------|--|
| <a href="#">Index</a> | See <i>FRAMEWIN</i> states on page 1278 for a full list of permitted values. |
| <a href="#">Color</a> | <a href="#">Color</a> to be used.  |

#### 6.2.9.4.1.40 FRAMEWIN\_SetDefaultTitleHeight()

##### Description

Sets the size in Y for the title bar.

##### Prototype

```
void FRAMEWIN_SetDefaultTitleHeight(int Height);
```

##### Parameters

| Parameter | Description    |
|-----------|----------------|
| Height    | Size to be set |

##### Additional information

The default value of the title height is 0. That means the height of the title depends on the font used to display the title text. If the default value is set to a value > 0 each new FRAMEWIN widget will use this height for the title height and not the height of the font of the title.

### 6.2.9.4.1.41 FRAMEWIN\_SetFont()



#### Description

Sets the title font of the FRAMEWIN widget.

#### Prototype

```
void FRAMEWIN_SetFont(    FRAMEWIN_Handle  hObj,
                        const GUI_FONT    * pFont);
```

#### Parameters

| Parameter | Description                |
|-----------|----------------------------|
| hObj      | Handle of FRAMEWIN widget. |
| pFont     | Pointer to the font.       |

### 6.2.9.4.1.42 FRAMEWIN\_SetMoveable()

#### Description

Sets a FRAMEWIN widget to a moveable or fixed state.

#### Prototype

```
void FRAMEWIN_SetMoveable(FRAMEWIN_Handle hObj,
                          int             State);
```

#### Parameters

| Parameter          | Description  |
|--------------------|--|
| <code>hObj</code>  | Handle of FRAMEWIN widget.                           |
| <code>State</code> | <code>State</code> of frame window. See table below. |

| Permitted values for parameter <code>State</code> |                                       |
|---|---------------------------------------|
| 0   | Frame window is fixed (non-moveable). |
| 1   | Frame window is moveable.             |

#### Additional information

The default state of a FRAMEWIN widget after creation is fixed. Moveable state means, the FRAMEWIN widget can be dragged with a pointer input device (PID). To move the FRAMEWIN widget, it first needs to be touched with a PID in pressed state in the title area. Moving the pressed PID now moves also the widget. If the config macro `FRAMEWIN_ALLOW_DRAG_ON_FRAME` is 1 (default), the FRAMEWIN widget can also be dragged on the surrounding frame. This works only if the FRAMEWIN widget is not in resizable state.

### 6.2.9.4.1.43 FRAMEWIN\_SetOwnerDraw()

#### Note

OwnerDraw routines for FRAMEWIN widgets are deprecated and only work in conjunction the classic skin.

#### Description

Enables the FRAMEWIN widget to be owner drawn.

#### Prototype

```
void FRAMEWIN_SetOwnerDraw(FRAMEWIN_Handle hObj,
                           WIDGET_DRAW_ITEM_FUNC * pfDrawItem);
```

#### Parameters

| Parameter  | Description                     |
|------------|---------------------------------|
| hObj       | Handle of FRAMEWIN widget.      |
| pfDrawItem | Pointer to owner draw function. |

#### Supported commands

- WIDGET\_ITEM\_DRAW

#### Additional information

This function sets a function pointer to a function which will be called by the widget if a FRAMEWIN widget has to be drawn. It gives you the possibility to draw a complete customized title bar, not just plain text. `pfDrawItem` is a pointer to an application-defined function of type `WIDGET_DRAW_ITEM_FUNC` which is explained at the beginning of the chapter.

#### Example

The following shows a typical owner draw function:

```
int _OwnerDraw(const WIDGET_DRAW_ITEM_INFO * pDrawItemInfo) {
    GUI_RECT Rect;
    char acBuffer[20];
    switch (pDrawItemInfo->Cmd) {
    case WIDGET_ITEM_DRAW:
        Rect.x0 = pDrawItemInfo->x0 + 1;
        Rect.x1 = pDrawItemInfo->x1 - 1;
        Rect.y0 = pDrawItemInfo->y0 + 1;
        Rect.y1 = pDrawItemInfo->y1;
        FRAMEWIN_GetText(pDrawItemInfo->hWin, acBuffer, sizeof(acBuffer));
        GUI_DrawGradientH(pDrawItemInfo->x0, pDrawItemInfo->y0,
                        pDrawItemInfo->x1, pDrawItemInfo->y1,
                        GUI_RED, GUI_GREEN);
        GUI_SetFont(FRAMEWIN_GetFont(pDrawItemInfo->hWin));
        GUI_SetTextMode(GUI_TM_TRANS);
        GUI_SetColor(GUI_YELLOW);
        GUI_DispStringInRect(acBuffer, &Rect,
                            FRAMEWIN_GetTextAlign(pDrawItemInfo->hWin));
        return 0;
    }
    return FRAMEWIN_OwnerDraw(pDrawItemInfo);
}
void CreateFrameWindow(void) {
    ...
    FRAMEWIN_SetOwnerDraw(hWin, _OwnerDraw);
    ...
}
```

```
}
```

### Screenshot of above example



#### 6.2.9.4.1.44 FRAMEWIN\_SetResizable()

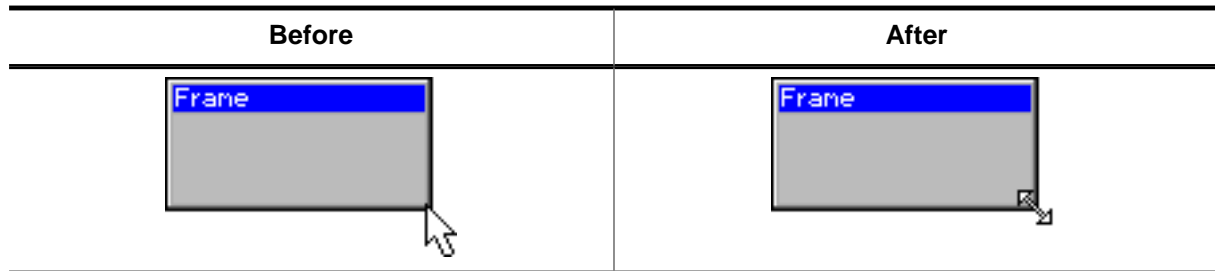

#### Description

Sets the resizable state of the given FRAMEWIN widget.

#### Prototype

```
void FRAMEWIN_SetResizable(FRAMEWIN_Handle hObj,
                           int State);
```

#### Parameters

| Parameter | Description  |
|-----------|--|
| hObj      | Handle of FRAMEWIN widget.                           |
| State     | 1 if the frame window should be resizable, 0 if not. |

#### Additional information

If the FRAMEWIN widget is in resizable state its size can be changed by dragging the borders. If a pointer input device points over the border, the cursor will change to a resize cursor (if cursor is on and if optional mouse support is enabled). If pointing to the edge of the border, the X and Y size of the window can be changed simultaneously.



### 6.2.9.4.1.45 FRAMEWIN\_SetText()



#### Description

Sets the title text.

#### Prototype

```
void FRAMEWIN_SetText(    FRAMEWIN_Handle  hObj,
                          const char      * s);
```

#### Parameters

| Parameter | Description                   |
|-----------|-------------------------------|
| hObj      | Handle of FRAMEWIN widget.    |
| s         | Text to display as the title. |

### 6.2.9.4.1.46 FRAMEWIN\_SetTextAlign()



#### Description

Sets the text alignment of the title bar.

#### Prototype

```
void FRAMEWIN_SetTextAlign(FRAMEWIN_Handle hObj,
                           int Align);
```

#### Parameters

| Parameter          | Description  |
|--------------------|--|
| <code>hObj</code>  | Handle of FRAMEWIN widget.   |
| <code>Align</code> | Alignment attribute for the title. List of flags can be found under <i>Text alignment flags</i> on page 252. |

#### Additional information

If this function is not called, the default behavior is to display the text centered.

### 6.2.9.4.1.47 FRAMEWIN\_SetTextColor()



#### Description

Sets the color of the title text for both states, active and inactive.

#### Prototype

```
void FRAMEWIN_SetTextColor(FRAMEWIN_Handle hObj,
                           GUI_COLOR      Color);
```

#### Parameters

| Parameter | Description                |
|-----------|----------------------------|
| hObj      | Handle of FRAMEWIN widget. |
| Color     | Color to be set.           |

### 6.2.9.4.1.48 FRAMEWIN\_SetTextColorEx()



#### Description

Sets the text color for the given state.

#### Prototype

```
void FRAMEWIN_SetTextColorEx(FRAMEWIN_Handle hObj,
                             unsigned Index,
                             GUI_COLOR Color);
```

#### Parameters

| Parameter          | Description  |
|--------------------|--|
| <code>hObj</code>  | Handle of FRAMEWIN widget.   |
| <code>Index</code> | See <i>FRAMEWIN states</i> on page 1278 for a full list of permitted values. |
| <code>Color</code> | <code>Color</code> to be used.   |

### 6.2.9.4.1.49 FRAMEWIN\_SetTitleHeight()

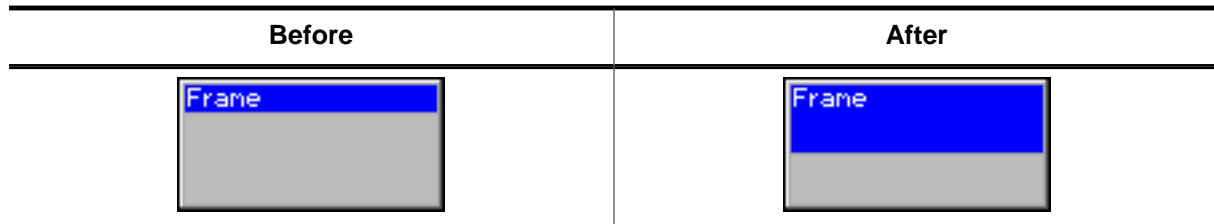

#### Description

Sets the height of the title bar.

#### Prototype

```
int FRAMEWIN_SetTitleHeight(FRAMEWIN_Handle hObj,
                           int Height);
```

#### Parameters

| Parameter | Description                |
|-----------|----------------------------|
| hObj      | Handle of FRAMEWIN widget. |
| Height    | Height of the title bar.   |

#### Additional information

Per default the height of the title bar depends on the size on the font used to display the title text. When using `FRAMEWIN_SetTitleHeight()` the height will be fixed to the given value. Changes of the font takes no effect concerning the height of the title bar. A value of 0 will restore the default behavior.

### 6.2.9.4.1.50 FRAMEWIN\_SetTitleVis()



#### Description

Sets the visibility flag of the title bar.

#### Prototype

```
void FRAMEWIN_SetTitleVis(FRAMEWIN_Handle hObj,
                          int Show);
```

#### Parameters

| Parameter | Description                           |
|-----------|---------------------------------------|
| hObj      | Handle of FRAMEWIN widget.            |
| Show      | 1 for visible (default), 0 for hidden |

#### 6.2.9.4.1.51 FRAMEWIN\_SetUserData()

##### Description

Prototype explained at the beginning of the chapter as `<WIDGET>_SetUserData()` on page 995.

## 6.2.9.4.2 Defines

### 6.2.9.4.2.1 FRAMEWIN button flags

#### Description

These flags determine on which side of the FRAMEWIN widget a button should be added.

#### Definition

```
#define FRAMEWIN_BUTTON_RIGHT    (1 << 0)
#define FRAMEWIN_BUTTON_LEFT    (1 << 1)
```

#### Symbols

| Definition                            | Description                                   |
|---------------------------------------|---|
| <a href="#">FRAMEWIN_BUTTON_RIGHT</a> | The BUTTON will be created at the right side. |
| <a href="#">FRAMEWIN_BUTTON_LEFT</a>  | The BUTTON will be created at the left side.  |



### 6.2.9.4.2 FRAMEWIN create flags

#### Description

Create flags that define the behavior of the FRAMEWIN widget. These flags are OR-combinable and can be specified upon creation of the widget via the `ExFlags` parameter of `FRAMEWIN_CreateEx()`.

#### Definition

```
#define FRAMEWIN_CF_ACTIVE      (1 << 3)
#define FRAMEWIN_CF_MOVEABLE   (1 << 4)
#define FRAMEWIN_CF_TITLEVIS   (1 << 5)
#define FRAMEWIN_CF_MINIMIZED  (1 << 6)
#define FRAMEWIN_CF_MAXIMIZED  (1 << 7)
#define FRAMEWIN_CF_DRAGGING   (1 << 8)
```

#### Symbols

| Definition                         | Description  |
|------------------------------------|--|
| <code>FRAMEWIN_CF_ACTIVE</code>    | Active-state of the frame window. See <code>FRAMEWIN_SetActive()</code> .            |
| <code>FRAMEWIN_CF_MOVEABLE</code>  | Sets the frame window to a moveable state. See <code>FRAMEWIN_SetMoveable()</code> . |
| <code>FRAMEWIN_CF_TITLEVIS</code>  | Visibility of the frame window's title. See <code>FRAMEWIN_SetTitleVis()</code> .    |
| <code>FRAMEWIN_CF_MINIMIZED</code> | Minimized-state of the frame window. See <code>FRAMEWIN_Minimize()</code> .          |
| <code>FRAMEWIN_CF_MAXIMIZED</code> | Maximized-state of the frame window. See <code>FRAMEWIN_Maximize()</code> .          |
| <code>FRAMEWIN_CF_DRAGGING</code>  | Internal use.  |

### 6.2.9.4.2.3 FRAMEWIN states

#### Description

State of the FRAMEWIN used for various functions.

#### Definition

```
#define FRAMEWIN_CI_INACTIVE    0
#define FRAMEWIN_CI_ACTIVE     1
```

#### Symbols

| Definition                           | Description                    |
|--------------------------------------|--------------------------------|
| <a href="#">FRAMEWIN_CI_INACTIVE</a> | When the FRAMEWIN is inactive. |
| <a href="#">FRAMEWIN_CI_ACTIVE</a>   | When the FRAMEWIN is active.   |

### 6.2.9.5 Example

The `Sample` folder contains the following example which shows how the widget can be used:

- `WIDGET_FrameWin.c`

Note that several other examples also make use of this widget and may also be helpful to get familiar with the widget.

**Screenshot of `WIDGET_FrameWin.c`:**



## 6.2.10 GAUGE: Gauge widget

The GAUGE widget displays a value in a certain range like a progress bar, but instead the progress is displayed in a radial manner. A GAUGE consists of two arcs that are drawn, a background line and a foreground line. The foreground line's length shows the set value of the GAUGE widget. Depending on the given angle, the widget can obviously also show two circles instead of two arcs.

### Note

All GAUGE-related routines are in the file(s) `GAUGE.c` and `GAUGE.h`.  
All identifiers are prefixed with `GAUGE`.

The GAUGE shown below has a gray background line and a green foreground line.

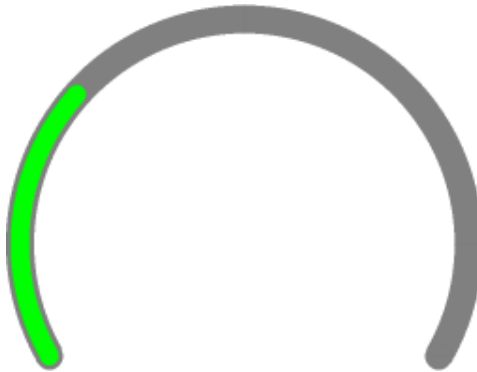

### 6.2.10.1 Configuration options

| Type | Macro                              | Default  | Description                   |
|------|------------------------------------|--|-------------------------------|
| N    | <code>GAUGE_ALIGN_DEFAULT</code>   | <code>GUI_TA_HCENTER</code>  <br><code>GUI_TA_VCENTER</code> | Alignment of the arc.         |
| N    | <code>GAUGE_BKCOLOR_DEFAULT</code> | <code>GUI_BLACK</code>                                       | Background color.             |
| N    | <code>GAUGE_COLOR0_DEFAULT</code>  | <code>GUI_WHITE</code>                                       | Color of the background line. |
| N    | <code>GAUGE_COLOR1_DEFAULT</code>  | <code>GUI_DARKGRAY</code>                                    | Color of the foreground line. |

### 6.2.10.2 Predefined IDs

The following symbols define IDs which may be used to make GAUGE widgets distinguishable from creation.

```
#define GUI_ID_GAUGE0    0x340
#define GUI_ID_GAUGE1    0x341
#define GUI_ID_GAUGE2    0x342
#define GUI_ID_GAUGE3    0x343
#define GUI_ID_GAUGE4    0x344
#define GUI_ID_GAUGE5    0x345
#define GUI_ID_GAUGE6    0x346
#define GUI_ID_GAUGE7    0x347
#define GUI_ID_GAUGE8    0x348
#define GUI_ID_GAUGE9    0x349
```

### 6.2.10.3 Notification codes

The following events are sent from a GAUGE widget to its parent window as part of a WM\_NOTIFY\_PARENT message:

| Message                       | Description                                     |
|-------------------------------|---|
| WM_NOTIFICATION_VALUE_CHANGED | The value of the GAUGE widget has been changed. |

### 6.2.10.4 Keyboard reaction

The widget can not receive input focus and therefore does not react on any keys.

### 6.2.10.5 GAUGE API

The table below lists the available emWin GAUGE-related routines in alphabetical order. Detailed descriptions of the routines follow.

#### Functions

| Routine                                 | Description  |
|---|--|
| <a href="#">GAUGE_CreateIndirect()</a>  | Creates a GAUGE widget from a resource table entry.                              |
| <a href="#">GAUGE_CreateUser()</a>      | Creates a GAUGE widget.  |
| <a href="#">GAUGE_GetRange()</a>        | Gets the range in angles where the GAUGE will be drawn.                          |
| <a href="#">GAUGE_GetValue()</a>        | Returns the current value of a GAUGE.  |
| <a href="#">GAUGE_SetAlign()</a>        | Sets the alignment of the arc drawn in the GAUGE widget.                         |
| <a href="#">GAUGE_SetBkColor()</a>      | Sets the background color of the GAUGE widget.                                   |
| <a href="#">GAUGE_SetColor()</a>        | Sets the color of the line drawn in the GAUGE widget.                            |
| <a href="#">GAUGE_SetOffset()</a>       | Sets an X and Y offset to the arc drawn in the GAUGE widget.                     |
| <a href="#">GAUGE_SetRadius()</a>       | Sets the radius of the GAUGE.  |
| <a href="#">GAUGE_SetRange()</a>        | Sets the range in angles where the GAUGE will be drawn.                          |
| <a href="#">GAUGE_SetRoundedEnd()</a>   | When enabled, the background line will be drawn with a rounded edge on the ends. |
| <a href="#">GAUGE_SetRoundedValue()</a> | When enabled, the foreground line will be drawn with a rounded edge on the ends. |
| <a href="#">GAUGE_SetValue()</a>        | Sets a new value for the GAUGE widget.   |
| <a href="#">GAUGE_SetValueRange()</a>   | Defines the range of the values shown by the GAUGE widget.                       |
| <a href="#">GAUGE_SetWidth()</a>        | Sets the width of the line drawn in the GAUGE widget.                            |

#### Defines

| Group of defines                   | Description   |
|------------------------------------|---|
| <a href="#">GAUGE curved flags</a> | Define if the GAUGE's arcs should have rounded edges. |

## 6.2.10.5.1 Functions

### 6.2.10.5.1.1 GAUGE\_CreateIndirect()

#### Description

Prototype explained at the beginning of the chapter as `<WIDGET>_CreateIndirect()` on page 992. The elements `Flags` and `Para` of the resource passed as parameter are not used.

### 6.2.10.5.1.2 GAUGE\_CreateUser()

#### Description

Creates a GAUGE widget.

#### Prototype

```
GAUGE_Handle GAUGE_CreateUser(int    x0,
                               int    y0,
                               int    xSize,
                               int    ySize,
                               WM_HWIN hParent,
                               int    WinFlags,
                               int    ExFlags,
                               int    Id,
                               int    NumExtraBytes);
```

#### Parameters

| Parameter                  | Description  |
|----------------------------|--|
| <code>x0</code>            | Leftmost pixel of the GAUGE widget (in parent coordinates).  |
| <code>y0</code>            | Topmost pixel of the GAUGE widget (in parent coordinates).   |
| <code>xSize</code>         | Horizontal size of the GAUGE widget (in pixels).   |
| <code>ySize</code>         | Vertical size of the GAUGE widget (in pixels).   |
| <code>hParent</code>       | Parent window of the GAUGE widget.   |
| <code>WinFlags</code>      | Window create flags. Typically <code>WM_CF_SHOW</code> in order to make the widget visible immediately (refer to <i>Window create flags</i> on page 977 for a list of available parameter values). |
| <code>ExFlags</code>       | See <i>GAUGE curved flags</i> on page 1297.  |
| <code>Id</code>            | ID of the GAUGE widget.  |
| <code>NumExtraBytes</code> | Number of extra bytes to be allocated.   |

#### Return value

Handle of the GAUGE widget.

### 6.2.10.5.1.3 GAUGE\_GetValue()

#### Description

Returns the current value of a GAUGE.

#### Prototype

```
I32 GAUGE_GetValue(GAUGE_Handle hObj);
```

#### Parameters

| Parameter            | Description             |
|----------------------|-------------------------|
| <a href="#">hObj</a> | Handle of GAUGE widget. |

#### Return value

Value of the GAUGE widget.



#### 6.2.10.5.1.4 GAUGE\_GetRange()

##### Description

Gets the range in angles where the GAUGE will be drawn.

##### Prototype

```
void GAUGE_GetRange(GAUGE_Handle  hObj,  
                   I32           * pAng0,  
                   I32           * pAng1);
```

##### Parameters

| Parameter             | Description                        |
|-----------------------|------------------------------------|
| <a href="#">hObj</a>  | Handle of GAUGE widget.            |
| <a href="#">pAng0</a> | Pointer to I32 for starting point. |
| <a href="#">pAng1</a> | Pointer to I32 for ending point.   |

### 6.2.10.5.1.5 GAUGE\_SetAlign()

#### Description

Sets the alignment of the arc drawn in the GAUGE widget.

#### Prototype

```
void GAUGE_SetAlign(GAUGE_Handle hObj,  
                   int           Align);
```

#### Parameters

| Parameter          | Description   |
|--------------------|---|
| <code>hObj</code>  | Handle of GAUGE widget.   |
| <code>Align</code> | Alignment of the arc in the widget area. <i>Text alignment flags</i> on page 252 can be used. |

### 6.2.10.5.1.6 GAUGE\_SetBkColor()

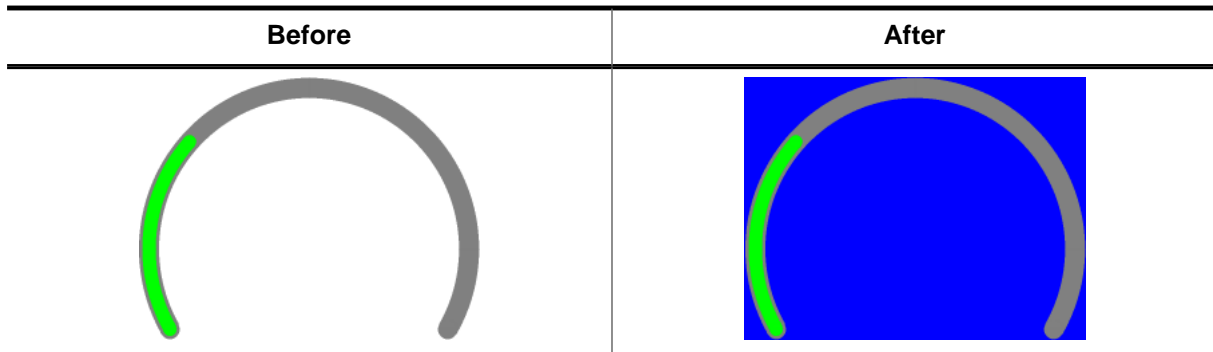

#### Description

Sets the background color of the GAUGE widget.

#### Prototype

```
void GAUGE_SetBkColor(GAUGE_Handle hObj,
                     GUI_COLOR   BkColor);
```

#### Parameters

| Parameter            | Description             |
|----------------------|-------------------------|
| <code>hObj</code>    | Handle of GAUGE widget. |
| <code>BkColor</code> | New background color.   |

### 6.2.10.5.1.7 GAUGE\_SetColor()

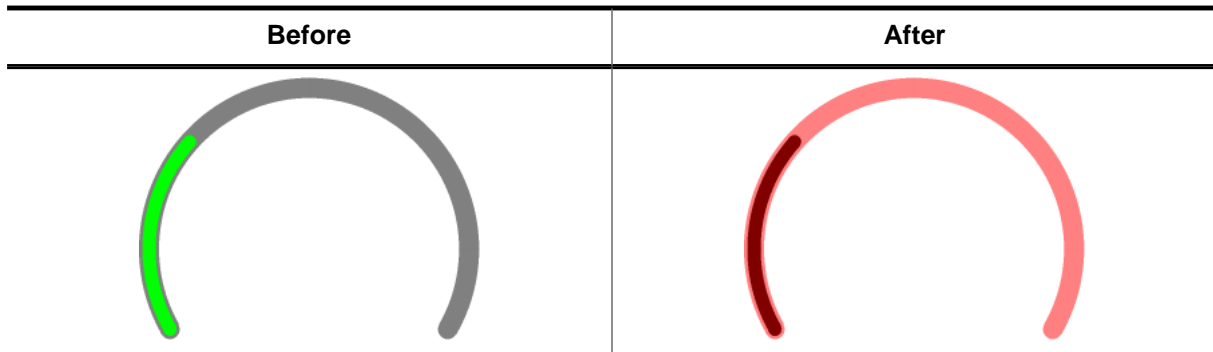

#### Description

Sets the color of the line drawn in the GAUGE widget.

#### Prototype

```
void GAUGE_SetColor(GAUGE_Handle hObj,
                   unsigned      Index,
                   GUI_COLOR      Color);
```

#### Parameters

| Parameter          | Description   |
|--------------------|---|
| <code>hObj</code>  | Handle of GAUGE widget.   |
| <code>Index</code> | Line index, 0 for the background line, 1 for the foreground line. |
| <code>Color</code> | <code>Color</code> of the specified line.                         |

### 6.2.10.5.1.8 GAUGE\_SetOffset()

#### Description

Sets an X and Y offset to the arc drawn in the GAUGE widget.

#### Prototype

```
void GAUGE_SetOffset(GAUGE_Handle hObj,  
                    int           xOff,  
                    int           yOff);
```

#### Parameters

| Parameter            | Description             |
|----------------------|-------------------------|
| <a href="#">hObj</a> | Handle of GAUGE widget. |
| <a href="#">xOff</a> | X-offset in pixels.     |
| <a href="#">yOff</a> | Y-offset in pixels.     |

### 6.2.10.5.1.9 GAUGE\_SetRadius()

#### Description

Sets the radius of the GAUGE.

#### Prototype

```
void GAUGE_SetRadius(GAUGE_Handle hObj,  
                    int          Radius);
```

#### Parameters

| Parameter           | Description                     |
|---------------------|---------------------------------|
| <code>hObj</code>   | Handle of GAUGE widget.         |
| <code>Radius</code> | <code>Radius</code> to be used. |

### 6.2.10.5.1.10 GAUGE\_SetRange()

#### Description

Sets the range in angles where the GAUGE will be drawn.

#### Prototype

```
void GAUGE_SetRange(GAUGE_Handle hObj,  
                   I32           Ang0,  
                   I32           Ang1);
```

#### Parameters

| Parameter            | Description              |
|----------------------|--------------------------|
| <a href="#">hObj</a> | Handle of GAUGE widget.  |
| <a href="#">Ang0</a> | Angle of starting point. |
| <a href="#">Ang1</a> | Angle of ending point.   |

#### Additional information

The angles have to be specified in 1000th of degrees. For example, 90° equals to 90000.

### 6.2.10.5.1.11 GAUGE\_SetRoundedEnd()

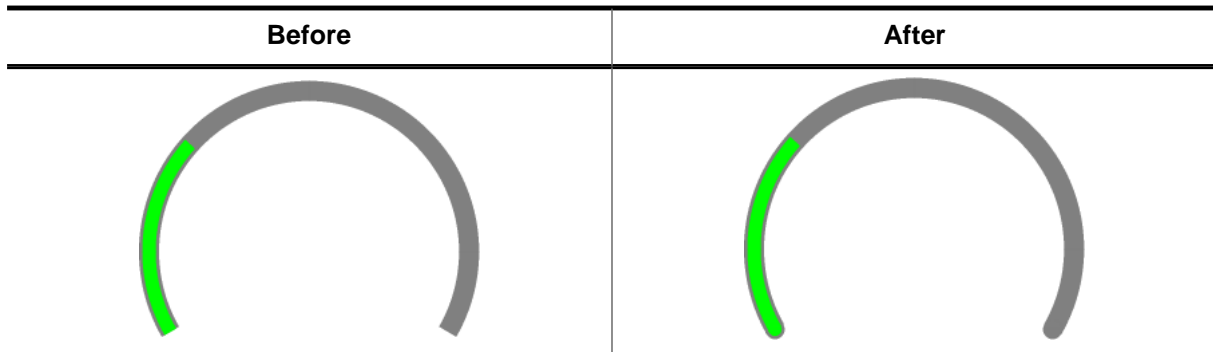

#### Description

When enabled, the background line will be drawn with a rounded edge on the ends.

#### Prototype

```
void GAUGE_SetRoundedEnd(GAUGE_Handle hObj,
                        int OnOff);
```

#### Parameters

| Parameter | Description                      |
|-----------|----------------------------------|
| hObj      | Handle of GAUGE widget.          |
| OnOff     | 1 for enabling, 0 for disabling. |



### 6.2.10.5.1.12 GAUGE\_SetRoundedValue()

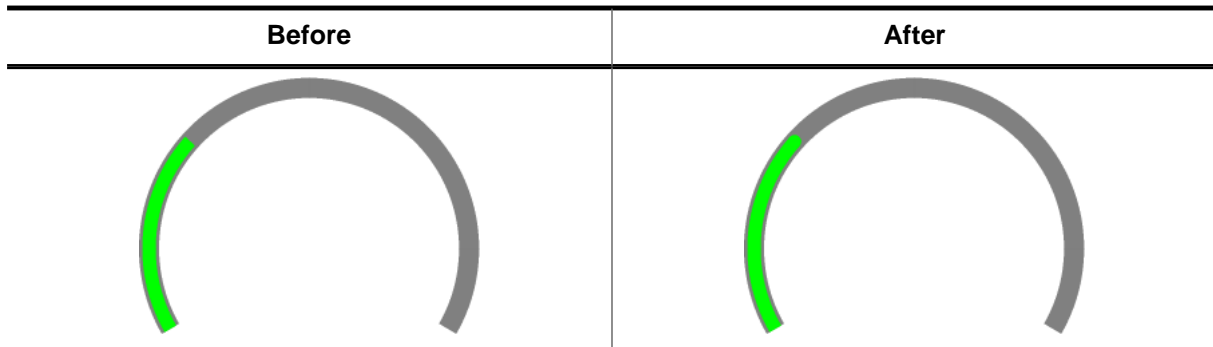

#### Description

When enabled, the foreground line will be drawn with a rounded edge on the ends. The foreground line is the line that displays the GAUGE's value.

#### Prototype

```
void GAUGE_SetRoundedValue(GAUGE_Handle hObj,
                           int          OnOff);
```

#### Parameters

| Parameter          | Description                      |
|--------------------|----------------------------------|
| <code>hObj</code>  | Handle of GAUGE widget.          |
| <code>OnOff</code> | 1 for enabling, 0 for disabling. |

### 6.2.10.5.1.13 GAUGE\_SetValue()

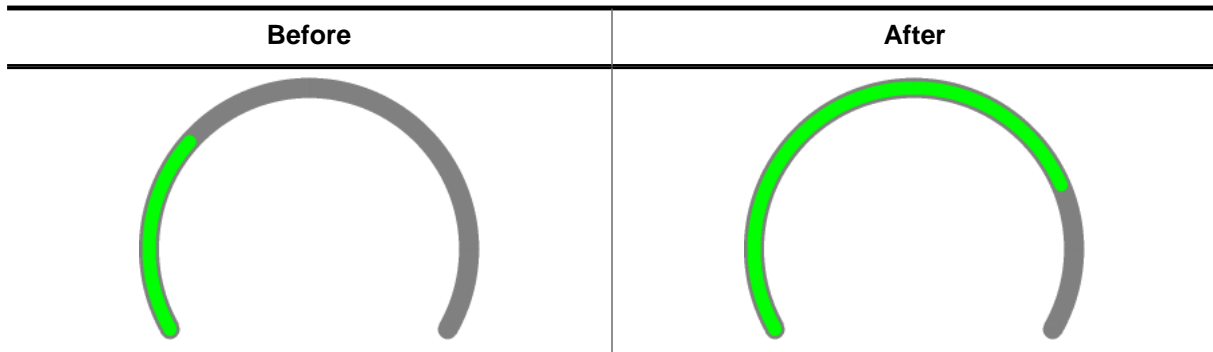

#### Description

Sets a new value for the GAUGE widget.

#### Prototype

```
void GAUGE_SetValue(GAUGE_Handle hObj,
                   I32          Value);
```

#### Parameters

| Parameter | Description             |
|-----------|-------------------------|
| hObj      | Handle of GAUGE widget. |
| Value     | New value to be set.    |

### 6.2.10.5.1.14 GAUGE\_SetValueRange()

#### Description

Defines the range of the values shown by the GAUGE widget.

#### Prototype

```
void GAUGE_SetValueRange(GAUGE_Handle hObj,  
                          I32          Min,  
                          I32          Max);
```

#### Parameters

| Parameter            | Description              |
|----------------------|--------------------------|
| <a href="#">hObj</a> | Handle of GAUGE widget.  |
| <a href="#">Min</a>  | Minimum value to be set. |
| <a href="#">Max</a>  | Maximum value to be set. |

### 6.2.10.5.1.15 GAUGE\_SetWidth()

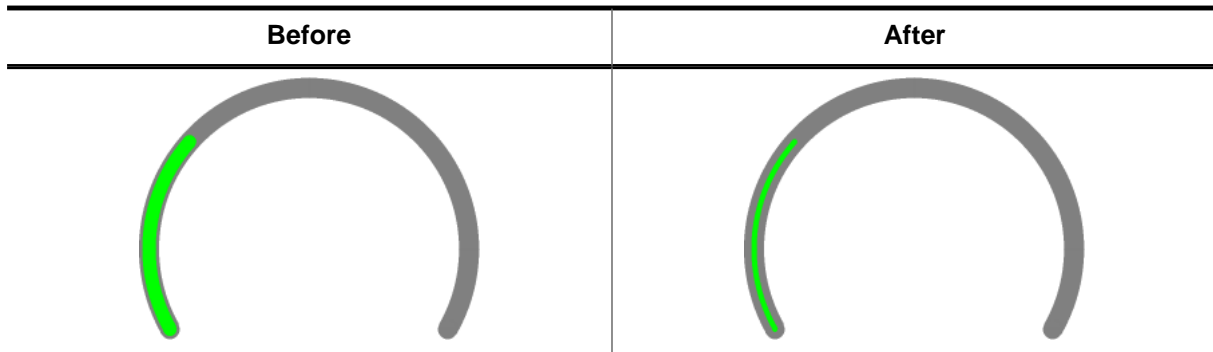

#### Description

Sets the width of the line drawn in the GAUGE widget.

#### Prototype

```
void GAUGE_SetWidth(GAUGE_Handle hObj,
                   unsigned Index,
                   int Width);
```

#### Parameters

| Parameter          | Description   |
|--------------------|---|
| <code>hObj</code>  | Handle of GAUGE widget.   |
| <code>Index</code> | Line index, 0 for the background line, 1 for the foreground line. |
| <code>Width</code> | <code>Width</code> of the specified line.                         |

## 6.2.10.5.2 Defines

### 6.2.10.5.2.1 GAUGE curved flags

#### Description

With these flags the drawing of the widget's arc lines can be set to have round edges. The flags can be used upon creation of the GAUGE widget.

#### Definition

```
#define GAUGE_CURVED_VALUE    (1 << 0)
#define GAUGE_CURVED_END    (1 << 1)
```

#### Symbols

| Definition                         | Description   |
|------------------------------------|---|
| <a href="#">GAUGE_CURVED_VALUE</a> | The arc that is drawn for the GAUGE's value will have a curved edge on the beginning and end of the line. |
| <a href="#">GAUGE_CURVED_END</a>   | The background arc will be drawn with a curved edge on the beginning and end of the line.                 |

## 6.2.11 GRAPH: Graph widget

GRAPH widgets can be used to visualize data. Typical applications for GRAPH widgets are showing measurement values or the curve of a function graph. Multiple curves can be shown simultaneously. Horizontal and vertical scales can be used to label the curves. A grid with different horizontal and vertical spacing can be shown on the background. If the data array does not fit into the visible area of the graph, the widget can automatically show scroll bars which allow scrolling through large data arrays.

### 6.2.11.1 Structure of the graph widget

A GRAPH widget consists of different kinds objects:

- The GRAPH widget itself to which data objects and scale objects can be attached.
- Optionally one or more data objects.
- Optionally one or more scale objects.

The following diagram shows the detailed structure of a graph widget:

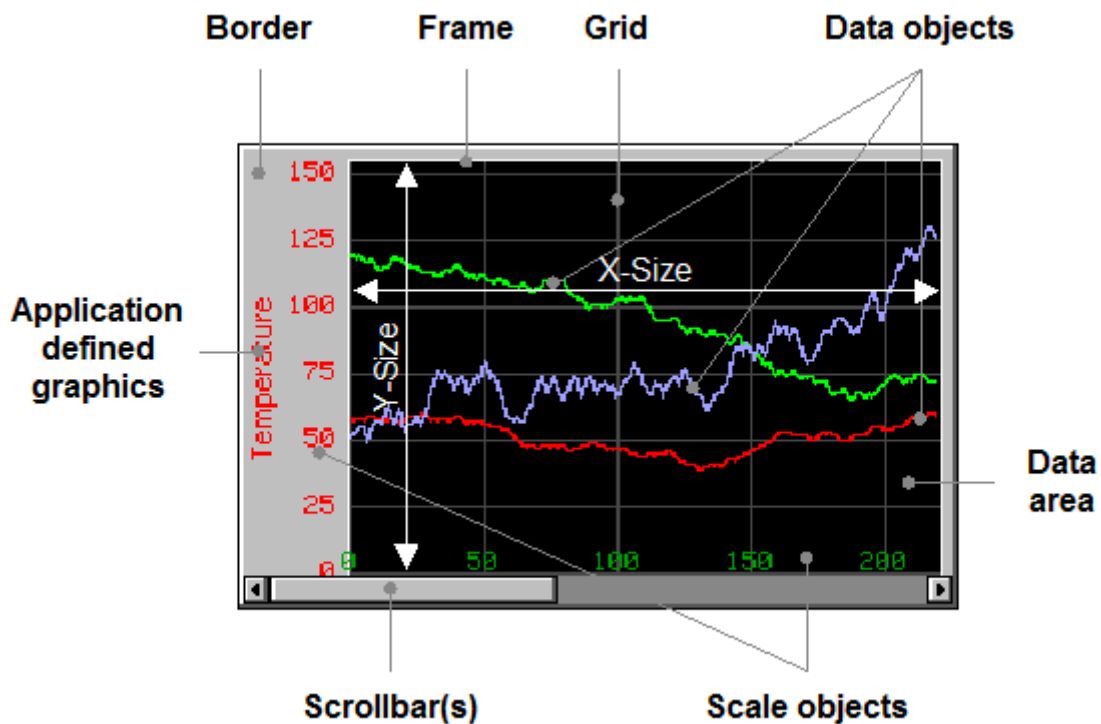

The following table explains the details of the diagram above:

| Detail                      | Description  |
|-----------------------------|--|
| Border                      | The optional border is part of the graph widget.   |
| Frame                       | A thin line around the data area, part of the graph widget.  |
| Grid                        | Shown in the background of the data area, part of the graph widget.  |
| Data area                   | Area, in which grid and data objects are shown.  |
| Data object(s)              | For each curve one data object should be added to the graph widget.  |
| Application defined graphic | An application defined callback function can be used to draw any application defined text and/or graphics.   |
| Scrollbar(s)                | If the range of the data object is bigger than the data area of the graph widget, the graph widget can automatically show a horizontal and/or a vertical scroll bar. |

| Detail                          | Description   |
|---------------------------------|---|
| <a href="#">Scale object(s)</a> | Horizontal and vertical scales can be attached to the graph widget. |
| <a href="#">X-Size</a>          | X-Size of the data area.  |
| <a href="#">Y-Size</a>          | Y-Size of the data area.  |

### 6.2.11.2 Creating and deleting a graph widget

The process of creating a GRAPH widget should be the following:

1. Create the GRAPH widget and set the desired attributes.
2. Create the data object(s).
3. Attach the data object(s) to the GRAPH widget.
4. Create the optional scale object(s).
5. Attach the scale object(s) to the GRAPH widget.

Once attached to the graph widget the data and scale objects need not to be deleted by the application. This is done by the graph widget.

#### Example

The following shows a small example how to create and delete a GRAPH widget:

```
GRAPH_DATA_Handle  hData;
GRAPH_SCALE_Handle hScale;
WM_HWIN hGraph;
hGraph = GRAPH_CreateEx(10, 10, 216, 106, WM_HBKWIN, WM_CF_SHOW, 0, GUI_ID_GRAPH0);
hData
    = GRAPH_DATA_YT_Create(GUI_DARKGREEN, NumDataItems, aData0, MaxNumDataItems);
GRAPH_AttachData(hGraph, hData);
hScale = GRAPH_SCALE_Create(28, GUI_TA_RIGHT, GRAPH_SCALE_CF_VERTICAL, 20);
GRAPH_AttachScale(hGraph, hScale);
/*
   Do something with the widget...
*/
WM_DeleteWindow(hGraph);
```

### 6.2.11.3 Drawing process

As explained above a GRAPH widget consists of different parts and 'sub' objects. The following will explain, in which sequence the widget is drawn:

1. Filling the background with the background color.
2. Calling an optional callback routine. This makes it possible to draw for example a user defined grid.
3. Drawing the grid (if enabled).
4. Drawing the data objects and the border area.
5. Drawing the scale objects.
6. Calling an optional callback routine. This makes it possible to draw for example a user defined scale or some additional text and/or graphics.

### 6.2.11.4 Supported types of curves

The requirements for showing a curve with continuously updated measurement values can be different to the requirements when showing a function graph with X/Y coordinates. For that reason the widget currently supports 2 kinds of data objects, which are shown in the table below:

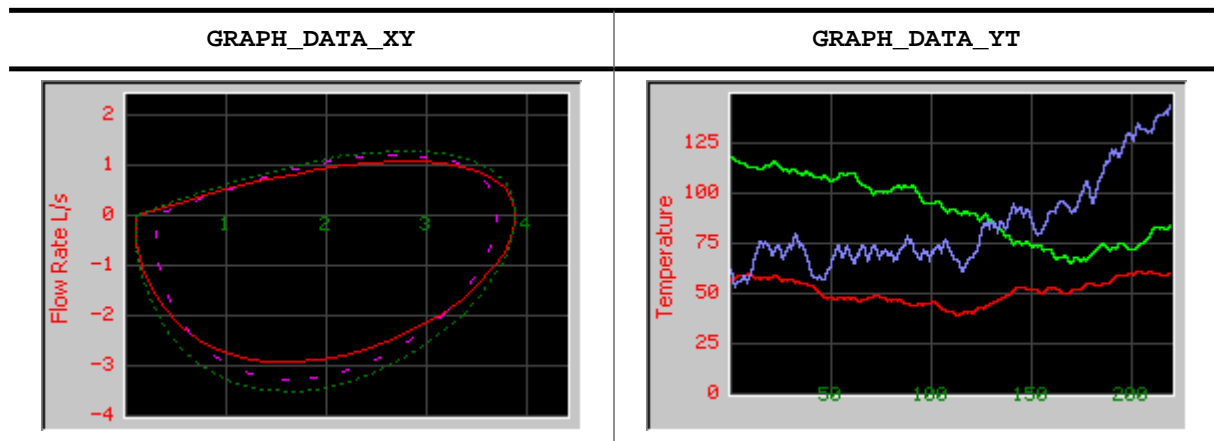

#### 6.2.11.4.1 GRAPH\_DATA\_XY

This data object is used to show curves which consist of an array of points. The object data is drawn as a polyline. A typical application for using this data object is drawing a function graph.

#### 6.2.11.4.2 GRAPH\_DATA\_YT

This data object is used to show curves with one Y-value for each X-position on the graph. A typical application for using this data object is showing a curve with continuously updated measurement values.

### 6.2.11.5 Configuration options

#### 6.2.11.5.1 Graph widget

| Type | Macro                       | Default      | Description                                |
|------|-----------------------------|--------------|--|
| N    | GRAPH_BKCOLOR_DEFAULT       | GUI_BLACK    | Default background color of the data area. |
| N    | GRAPH_BORDERCOLOR_DEFAULT   | 0xC0C0C0     | Default background color of the border.    |
| N    | GRAPH_FRAMECOLOR_DEFAULT    | GUI_WHITE    | Default color of the thin frame line.      |
| N    | GRAPH_GRIDCOLOR_DEFAULT     | GUI_DARKGRAY | Default color used to draw the grid.       |
| N    | GRAPH_GRIDSPACING_X_DEFAULT | 50           | Default horizontal spacing of the grid.    |
| N    | GRAPH_GRIDSPACING_Y_DEFAULT | 50           | Default vertical spacing of the grid.      |
| N    | GRAPH_BORDER_L_DEFAULT      | 0            | Default size of the left border.           |
| N    | GRAPH_BORDER_T_DEFAULT      | 0            | Default size of the top border.            |
| N    | GRAPH_BORDER_R_DEFAULT      | 0            | Default size of the right border.          |
| N    | GRAPH_BORDER_B_DEFAULT      | 0            | Default size of the bottom border.         |

#### 6.2.11.5.2 Scale object

| Type | Macro                         | Default      | Description                           |
|------|-------------------------------|--------------|---------------------------------------|
| N    | GRAPH_SCALE_TEXTCOLOR_DEFAULT | GUI_WHITE    | Default text color.                   |
| S    | GRAPH_SCALE_FONT_DEFAULT      | &GUI_Font6x8 | Default font used to draw the values. |



### 6.2.11.6 Predefined IDs

The following symbols define IDs which may be used to make GRAPH widgets distinguishable from creation.

```
#define GUI_ID_GRAPH0      0x220
#define GUI_ID_GRAPH1      0x221
#define GUI_ID_GRAPH2      0x222
#define GUI_ID_GRAPH3      0x223
#define GUI_ID_GRAPH4      0x224
#define GUI_ID_GRAPH5      0x225
#define GUI_ID_GRAPH6      0x226
#define GUI_ID_GRAPH7      0x227
#define GUI_ID_GRAPH8      0x228
#define GUI_ID_GRAPH9      0x229
```

### 6.2.11.7 Keyboard reaction

The widget can not gain the input focus and does not react on keyboard input.

### 6.2.11.8 GRAPH API

The table below lists the available emWin GRAPH-related routines in alphabetical order. Detailed descriptions of the routines follow.

#### Functions

| Routine                                  | Description  |
|--|--|
| Common routines                          |  |
| <a href="#">GRAPH_AttachData()</a>       | Attaches a data object to an existing GRAPH widget.                    |
| <a href="#">GRAPH_AttachScale()</a>      | Attaches a scale object to an existing GRAPH widget.                   |
| <a href="#">GRAPH_CreateEx()</a>         | Creates a GRAPH widget.  |
| <a href="#">GRAPH_CreateIndirect()</a>   | Creates a GRAPH widget from a resource table entry.                    |
| <a href="#">GRAPH_CreateUser()</a>       | Creates a GRAPH widget using extra bytes as user data.                 |
| <a href="#">GRAPH_DetachData()</a>       | Detaches a data object from a GRAPH widget.                            |
| <a href="#">GRAPH_DetachScale()</a>      | Detaches a scale object from a GRAPH widget.                           |
| <a href="#">GRAPH_GetColor()</a>         | This function returns one of the colors set for the GRAPH widget.      |
| <a href="#">GRAPH_GetScrollValue()</a>   | Returns the current scroll value for the given scrollbar.              |
| <a href="#">GRAPH_GetUserData()</a>      | Retrieves the data set with <a href="#">GRAPH_SetUserData()</a> .      |
| <a href="#">GRAPH_InvertScrollbar()</a>  | Inverts the direction of the attached scrollbars.                      |
| <a href="#">GRAPH_SetAutoScrollbar()</a> | Sets the automatic use of scroll bars.                                 |
| <a href="#">GRAPH_SetBorder()</a>        | Sets the left, top, right and bottom border of the given GRAPH widget. |
| <a href="#">GRAPH_SetColor()</a>         | Sets the desired color of the given GRAPH widget.                      |
| <a href="#">GRAPH_SetGridDistX()</a>     | Sets the horizontal grid spacing.                                      |
| <a href="#">GRAPH_SetGridDistY()</a>     | Sets the vertical grid spacing.  |
| <a href="#">GRAPH_SetGridFixedX()</a>    | Fixes the grid in X-axis.  |
| <a href="#">GRAPH_SetGridOffX()</a>      | Adds an offset used to show the vertical grid lines.                   |

| Routine                                      | Description  |
|--|--|
| <a href="#">GRAPH_SetGridOffY()</a>          | Adds an offset used to show the horizontal grid lines.         |
| <a href="#">GRAPH_SetGridVis()</a>           | Sets the visibility of the grid lines.                         |
| <a href="#">GRAPH_SetLineStyleH()</a>        | Sets the line style used to draw the horizontal grid lines.    |
| <a href="#">GRAPH_SetLineStyleV()</a>        | Sets the line style used to draw the vertical grid lines.      |
| <a href="#">GRAPH_SetScrollValue()</a>       | Sets the scroll value for the given scroll bar.                |
| <a href="#">GRAPH_SetUserData()</a>          | Sets the extra data of a GRAPH widget.                         |
| <a href="#">GRAPH_SetUserDraw()</a>          | Sets the user draw function.                                   |
| <a href="#">GRAPH_SetVSizeX()</a>            | Sets the virtual size in X-axis.                               |
| <a href="#">GRAPH_SetVSizeY()</a>            | Sets the virtual size in Y-axis.                               |
| GRAPH_DATA_YT related routines               |  |
| <a href="#">GRAPH_DATA_YT_AddValue()</a>     | Adds a new data item to a GRAPH_DATA_YT object.                |
| <a href="#">GRAPH_DATA_YT_Clear()</a>        | Clears all data items of the data object.                      |
| <a href="#">GRAPH_DATA_YT_Create()</a>       | Creates a GRAPH_DATA_YT object.                                |
| <a href="#">GRAPH_DATA_YT_Delete()</a>       | Deletes the given data object.                                 |
| <a href="#">GRAPH_DATA_YT_GetValue()</a>     | Returns value for the given index.                             |
| <a href="#">GRAPH_DATA_YT_MirrorX()</a>      | Mirrors the x-axis of the widget.                              |
| <a href="#">GRAPH_DATA_YT_SetAlign()</a>     | Sets the alignment of the data.                                |
| <a href="#">GRAPH_DATA_YT_SetColor()</a>     | This function sets a color for the given data object.          |
| <a href="#">GRAPH_DATA_YT_SetOffY()</a>      | Sets a vertical offset used to draw the object data.           |
| GRAPH_DATA_XY related routines               |  |
| <a href="#">GRAPH_DATA_XY_AddPoint()</a>     | Adds a new data item to a GRAPH_DATA_XY object.                |
| <a href="#">GRAPH_DATA_XY_Clear()</a>        | Clears all data items of the data object.                      |
| <a href="#">GRAPH_DATA_XY_Create()</a>       | Creates a GRAPH_DATA_XY object.                                |
| <a href="#">GRAPH_DATA_XY_Delete()</a>       | Deletes the given data object.                                 |
| <a href="#">GRAPH_DATA_XY_GetLineVis()</a>   | Returns if the line of the data object is visible.             |
| <a href="#">GRAPH_DATA_XY_GetPoint()</a>     | Returns a point for the given index.                           |
| <a href="#">GRAPH_DATA_XY_GetPointVis()</a>  | Returns if the points of a data object have been made visible. |
| <a href="#">GRAPH_DATA_XY_SetColor()</a>     | This function sets a color for the given data object.          |
| <a href="#">GRAPH_DATA_XY_SetLineStyle()</a> | Sets the line style used to draw the polyline.                 |
| <a href="#">GRAPH_DATA_XY_SetLineVis()</a>   | Sets the visibility of the data object's line.                 |
| <a href="#">GRAPH_DATA_XY_SetOffX()</a>      | Sets a horizontal offset used to draw the polyline.            |
| <a href="#">GRAPH_DATA_XY_SetOffY()</a>      | Sets a vertical offset used to draw the polyline.              |
| <a href="#">GRAPH_DATA_XY_SetOwnerDraw()</a> | Sets the owner callback function.                              |
| <a href="#">GRAPH_DATA_XY_SetPenSize()</a>   | Sets the pen size used to draw the polyline.                   |
| <a href="#">GRAPH_DATA_XY_SetPointVis()</a>  | Makes all points of a data object visible.                     |
| Scale related routines                       |  |
| <a href="#">GRAPH_SCALE_Create()</a>         | Creates a GRAPH_SCALE object.                                  |
| <a href="#">GRAPH_SCALE_Delete()</a>         | Deletes the given scale object.                                |
| <a href="#">GRAPH_SCALE_SetFactor()</a>      | Sets a factor used to calculate the numbers to be drawn.       |
| <a href="#">GRAPH_SCALE_SetFont()</a>        | Sets the font used to draw the scale numbers.                  |

| Routine                                 | Description  |
|---|--|
| <code>GRAPH_SCALE_SetNumDecs()</code>   | Sets the number of post decimal positions to be shown.                             |
| <code>GRAPH_SCALE_SetOff()</code>       | Sets an offset used to 'shift' the scale object in positive or negative direction. |
| <code>GRAPH_SCALE_SetPos()</code>       | Sets the position for showing the scale object within the GRAPH widget.            |
| <code>GRAPH_SCALE_SetTextColor()</code> | Sets the text color used to draw the numbers.                                      |
| <code>GRAPH_SCALE_SetTickDist()</code>  | Sets the distance from one number to the next.                                     |

## Defines

| Group of defines                    | Description                                     |
|-------------------------------------|---|
| <code>GRAPH alignment flags</code>  | Determine the alignment of the date of a graph. |
| <code>GRAPH color indexes</code>    | Color indexes used by the GRAPH widget.         |
| <code>GRAPH create flags</code>     | Create flags used for GRAPH widgets.            |
| <code>GRAPH user draw stages</code> | Color indexes used by the GRAPH widget.         |
| <code>SCALE create flags</code>     | Create flags used for scale objects.            |

### 6.2.11.8.1 Common routines

#### 6.2.11.8.1.1 GRAPH\_AttachData()

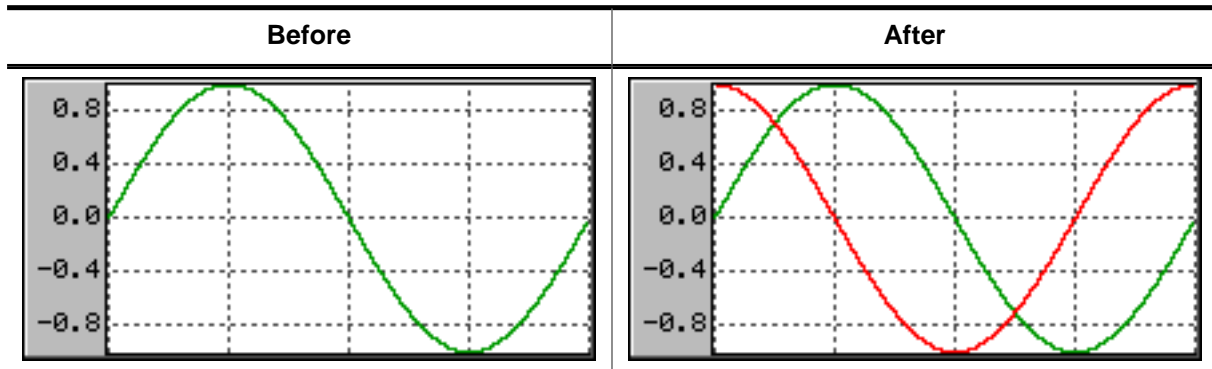

#### Description

Attaches a data object to an existing GRAPH widget.

#### Prototype

```
void GRAPH_AttachData(GRAPH_Handle hObj,
                     GRAPH_DATA_Handle hData);
```

#### Parameters

| Parameter          | Description  |
|--------------------|--|
| <code>hObj</code>  | Handle of GRAPH widget   |
| <code>hData</code> | Handle of the data object to be added to the widget. The data object should be created with <code>GRAPH_DATA_YT_Create()</code> or <code>GRAPH_DATA_XY_Create()</code> . |

#### Additional information

Once attached to a GRAPH widget the application does not need to destroy the data object. The GRAPH widget deletes all attached data objects when it is deleted. For details about how to create data objects, refer to `GRAPH_DATA_YT_Create()` and `GRAPH_DATA_XY_Create()`.

### 6.2.11.8.1.2 GRAPH\_AttachScale()

#### Description

Attaches a scale object to an existing GRAPH widget.

#### Prototype

```
void GRAPH_AttachScale(GRAPH_Handle hObj,  
                      GRAPH_SCALE_Handle hScale);
```

#### Parameters

| Parameter           | Description                      |
|---------------------|----------------------------------|
| <code>hObj</code>   | Handle of GRAPH widget           |
| <code>hScale</code> | Handle of the scale to be added. |

#### Additional information

Once attached to a GRAPH widget the application does not need to destroy the scale object. The GRAPH widget deletes all attached scale objects when it is deleted. For details about how to create scale objects, refer to *GRAPH\_SCALE\_Create* on page 1353.

### 6.2.11.8.1.3 GRAPH\_CreateEx()

#### Description

Creates a new GRAPH widget of a specified size at a specified location.

#### Prototype

```
GRAPH_Handle GRAPH_CreateEx(int    x0,
                             int    y0,
                             int    xSize,
                             int    ySize,
                             WM_HWIN hParent,
                             int    WinFlags,
                             int    ExFlags,
                             int    Id);
```

#### Parameters

| Parameter             | Description  |
|-----------------------|--|
| <code>x0</code>       | Leftmost pixel of the widget (in parent coordinates).  |
| <code>y0</code>       | Topmost pixel of the widget (in parent coordinates).   |
| <code>xSize</code>    | Horizontal size of the widget (in pixels).   |
| <code>ySize</code>    | Vertical size of the widget (in pixels).   |
| <code>hParent</code>  | Handle of parent window. If 0, the new button window will be a child of the desktop (top-level window).  |
| <code>WinFlags</code> | Window create flags. Typically <code>WM_CF_SHOW</code> in order to make the widget visible immediately (refer to <i>Window create flags</i> on page 977 for a list of available parameter values). |
| <code>ExFlags</code>  | See <i>GRAPH create flags</i> on page 1364.  |
| <code>Id</code>       | Window <code>Id</code> of the widget.  |

#### Return value

Handle of the created GRAPH widget; 0 if the function fails.

#### 6.2.11.8.1.4 GRAPH\_CreateIndirect()

##### Description

The prototype of this function is explained at the beginning of this chapter. Details can be found in the description of the function `<WIDGET>_CreateIndirect()` on page 992. The element `Para` of the according `GUI_WIDGET_CREATE_INFO` structure is not used. The element `Flags` is used according to the parameter `ExFlags` of the function `GRAPH_CreateEx()`.

### 6.2.11.8.1.5 GRAPH\_CreateUser()

#### Description

Prototype explained at the beginning of the chapter as `<WIDGET>_CreateUser()` on page 993. For a detailed description of the parameters the function `GRAPH_CreateEx()` can be referred to.



### 6.2.11.8.1.6 GRAPH\_DetachData()

#### Description

Detaches a data object from a GRAPH widget.

#### Prototype

```
void GRAPH_DetachData(GRAPH_Handle hObj,  
                      GRAPH_DATA_Handle hData);
```

#### Parameters

| Parameter             | Description   |
|-----------------------|---|
| <a href="#">hObj</a>  | Handle of GRAPH widget                                    |
| <a href="#">hData</a> | Handle of the data object to be detached from the widget. |

#### Additional information

Once detached from a GRAPH widget the application needs to destroy the data object. Detaching a data object does not delete it. For more details about deleting data objects, refer to [GRAPH\\_DATA\\_YT\\_Delete\(\)](#) and [GRAPH\\_DATA\\_XY\\_Delete\(\)](#).

### 6.2.11.8.1.7 GRAPH\_DetachScale()

#### Description

Detaches a scale object from a GRAPH widget.

#### Prototype

```
void GRAPH_DetachScale(GRAPH_Handle hObj,  
                       GRAPH_SCALE_Handle hScale);
```

#### Parameters

| Parameter           | Description  |
|---------------------|--|
| <code>hObj</code>   | Handle of GRAPH widget                                     |
| <code>hScale</code> | Handle of the scale object to be detached from the widget. |

#### Additional information

Once detached from a GRAPH widget the application needs to destroy the scale object. Detaching a scale object does not delete it. For more details about deleting scale objects, refer to `GRAPH_SCALE_Delete()`.

### 6.2.11.8.1.8 GRAPH\_GetColor()

#### Description

This function returns one of the colors set for the GRAPH widget.

#### Prototype

```
GUI_COLOR GRAPH_GetColor(GRAPH_Handle hObj,  
                          unsigned      Index);
```

#### Parameters

| Parameter             | Description  |
|-----------------------|--|
| <a href="#">hObj</a>  | Handle of GRAPH widget   |
| <a href="#">Index</a> | See <i>GRAPH color indexes</i> on page 1363 for a full list of permitted values. |

#### Return value

The color which corresponds to the given index.

### 6.2.11.8.1.9 GRAPH\_GetScrollValue()

#### Description

Returns the current scroll value for the given scroll bar.

#### Prototype

```
I32 GRAPH_GetScrollValue(GRAPH_Handle hObj,
                        U8          Coord);
```

#### Parameters

| Parameter             | Description            |
|-----------------------|------------------------|
| <a href="#">hObj</a>  | Handle of GRAPH widget |
| <a href="#">Coord</a> | See table below.       |

| Permitted values for parameter <a href="#">Coord</a> |                                  |
|--|----------------------------------|
| GUI_COORD_X  | Get the horizontal scroll value. |
| GUI_COORD_Y  | Get the vertical scroll value.   |

#### Return value

Current scroll value. -1, if scroll value could not be determined.

#### 6.2.11.8.1.10 GRAPH\_GetUserData()

##### Description

Prototype explained at the beginning of the chapter as `<WIDGET>_GetUserData()` on page 994.

### 6.2.11.8.1.11 GRAPH\_InvertScrollbar()

#### Description

This function inverts the direction of the attached scrollbars.

#### Prototype

```
void GRAPH_InvertScrollbar(GRAPH_Handle hObj,  
                           U8          Coord);
```

#### Parameters

| Parameter             | Description            |
|-----------------------|------------------------|
| <a href="#">hObj</a>  | Handle of GRAPH widget |
| <a href="#">Coord</a> | See table below.       |

| Permitted values for parameter <a href="#">Coord</a> |                                   |
|--|-----------------------------------|
| GUI_COORD_X  | Inverts the horizontal scrollbar. |
| GUI_COORD_Y  | Inverts the vertical scrollbar.   |

### 6.2.11.8.1.12 GRAPH\_SetAutoScrollbar()

#### Description

Sets the automatic use of scroll bars.

#### Prototype

```
void GRAPH_SetAutoScrollbar(GRAPH_Handle hObj,
                           U8          Coord,
                           U8          OnOff);
```

#### Parameters

| Parameter             | Description  |
|-----------------------|--|
| <a href="#">hObj</a>  | Handle of GRAPH widget   |
| <a href="#">Coord</a> | See table below.   |
| <a href="#">OnOff</a> | 1 the scroll bar should be used automatically. 0, if the scroll bar should not be created automatically. |

| Permitted values for parameter <a href="#">Coord</a> |  |
|--|--|
| GUI_COORD_X  | Toggle automatic creation of the horizontal scrollbar. |
| GUI_COORD_Y  | Toggle automatic creation of the vertical scrollbar.   |

### 6.2.11.8.1.13 GRAPH\_SetBorder()

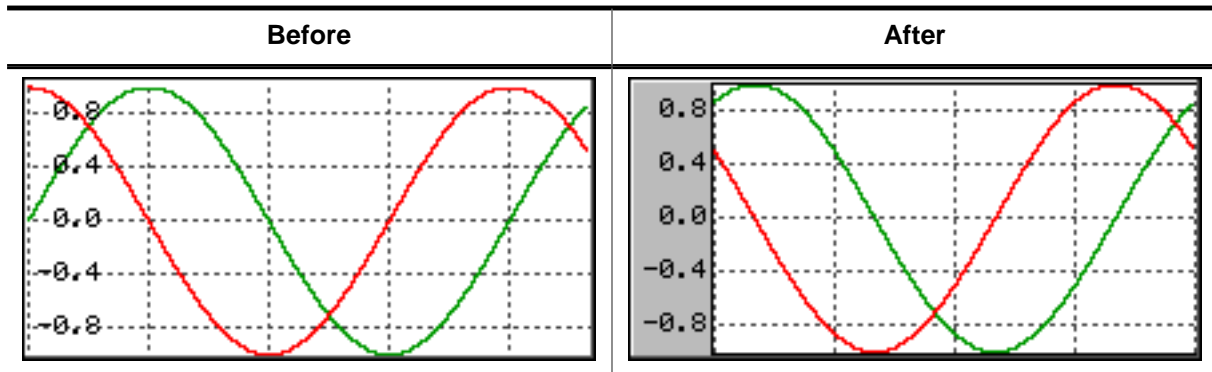

#### Description

Sets the left, top, right and bottom border of the given GRAPH widget.

#### Prototype

```
void GRAPH_SetBorder(GRAPH_Handle hObj,
                    unsigned BorderL,
                    unsigned BorderT,
                    unsigned BorderR,
                    unsigned BorderB);
```

#### Parameters

| Parameter               | Description                            |
|-------------------------|--|
| <a href="#">hObj</a>    | Handle of GRAPH widget.                |
| <a href="#">BorderL</a> | Size in pixels from the left border.   |
| <a href="#">BorderT</a> | Size in pixels from the top border.    |
| <a href="#">BorderR</a> | Size in pixels from the right border.  |
| <a href="#">BorderB</a> | Size in pixels from the bottom border. |

#### Additional information

The border size is the number of pixels between the widget effect frame and the data area of the GRAPH widget. The frame, the thin line around the data area, is only visible if the border size is at least one pixel. For details about how to set the color of the border and the thin frame, refer to [GRAPH\\_SetColor\(\)](#).



### 6.2.11.8.1.14 GRAPH\_SetColor()

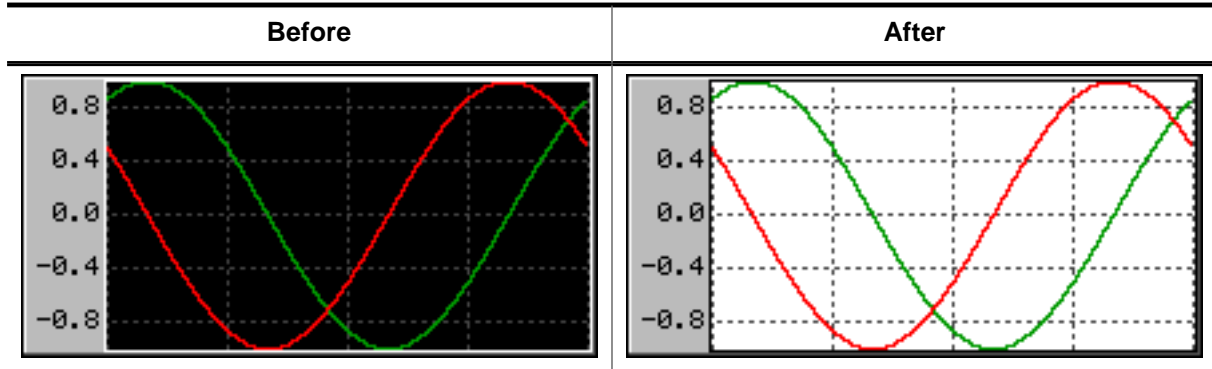

#### Description

Sets the desired color of the given GRAPH widget.

#### Prototype

```
GUI_COLOR GRAPH_SetColor(GRAPH_Handle hObj,
                          GUI_COLOR   Color,
                          unsigned     Index);
```

#### Parameters

| Parameter          | Description  |
|--------------------|--|
| <code>hObj</code>  | Handle of GRAPH widget.  |
| <code>Color</code> | <code>Color</code> to be used for the desired item.                              |
| <code>Index</code> | See <i>GRAPH color indexes</i> on page 1363 for a full list of permitted values. |

#### Return value

Previous color used for the desired item.

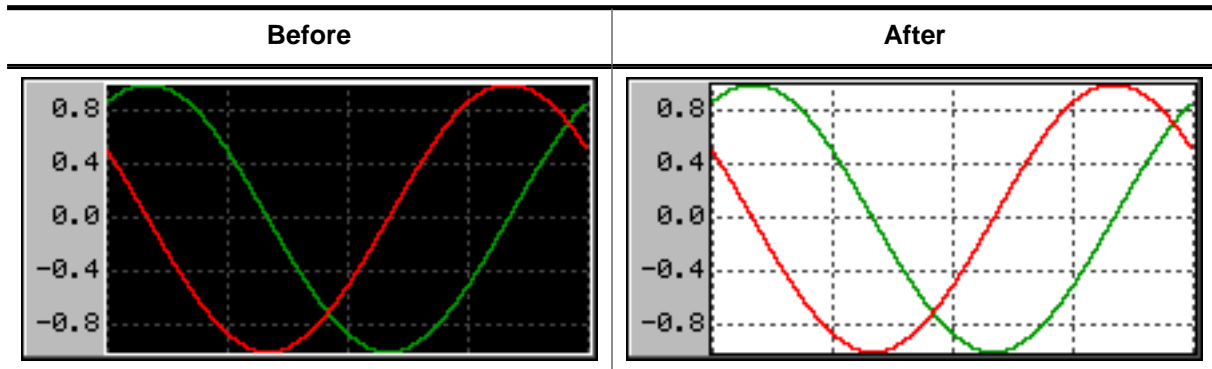
**6.2.11.8.1.15 GRAPH\_SetGridDistX()****6.2.11.8.1.16 GRAPH\_SetGridDistY()****Description**

These functions set the distance from one grid line to the next.

**Prototypes**

```
unsigned GRAPH_SetGridDistX(GRAPH_Handle hObj,
                           unsigned      Value);
```

```
unsigned GRAPH_SetGridDistY(GRAPH_Handle hObj,
                           unsigned      Value);
```

**Parameters**

| Parameter | Description   |
|-----------|---|
| hObj      | Handle of GRAPH widget.   |
| Value     | Distance in pixels from one grid line to the next, default is 50 pixel. |

**Return value**

Previous grid line distance.

**Additional information**

The first vertical grid line is drawn at the leftmost position of the data area and the first horizontal grid line is drawn at the bottom position of the data area, except an offset is used.

### 6.2.11.8.1.17 GRAPH\_SetGridFixedX()

#### Description

Fixes the grid in X-axis.

#### Prototype

```
unsigned GRAPH_SetGridFixedX(GRAPH_Handle hObj,  
                             unsigned      OnOff);
```

#### Parameters

| Parameter          | Description  |
|--------------------|--|
| <code>hObj</code>  | Handle of GRAPH widget.                                  |
| <code>OnOff</code> | 1 if grid should be fixed in X-axis, 0 if not (default). |

#### Return value

Previous value used.

#### Additional information

In some situations it can be useful to fix the grid in X-axis. A typical application would be a YT-graph, to which continuously new values are added and horizontal scrolling is possible. In this case it could be desirable to fix the grid in the background. For details about how to activate scrolling for a GRAPH widget, refer to `GRAPH_SetVSizeX()`.

### 6.2.11.8.1.18 GRAPH\_SetGridOffX()

#### Description

Adds an offset used to show the vertical grid lines. Similar to GRAPH\_SetGridOffY().

#### Prototype

```
unsigned GRAPH_SetGridOffX(GRAPH_Handle hObj,  
                           unsigned Value);
```

#### Parameters

| Parameter             | Description             |
|-----------------------|-------------------------|
| <a href="#">hObj</a>  | Handle of GRAPH widget. |
| <a href="#">Value</a> | Offset to be used.      |

#### Return value

Previous offset used to draw the vertical grid lines.

### 6.2.11.8.1.19 GRAPH\_SetGridOffY()

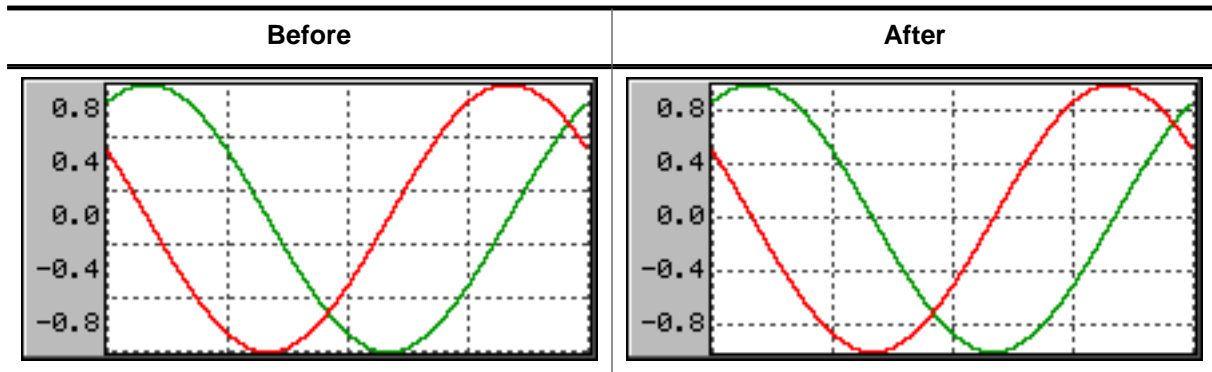

#### Description

Adds an offset used to show the horizontal grid lines.

#### Prototype

```
unsigned GRAPH_SetGridOffY(GRAPH_Handle hObj,
                           unsigned Value);
```

#### Parameters

| Parameter          | Description             |
|--------------------|-------------------------|
| <code>hObj</code>  | Handle of GRAPH widget. |
| <code>Value</code> | Offset to be used.      |

#### Return value

Previous offset used to draw the horizontal grid lines.

#### Additional information

When rendering the grid the widget starts drawing the horizontal grid lines from the bottom of the data area and uses the current spacing. In case of a zero point in the middle of the Y-axis it could happen, that there is no grid line in the middle. In this case the grid can be shifted in Y-axis by adding an offset with this function. A positive value shifts the grid down and negative values shifts it up.

For details about how to set the grid spacing, refer to the functions `GRAPH_SetGridDistX()` and `GRAPH_SetGridDistY()`.

### 6.2.11.8.1.20 GRAPH\_SetGridVis()

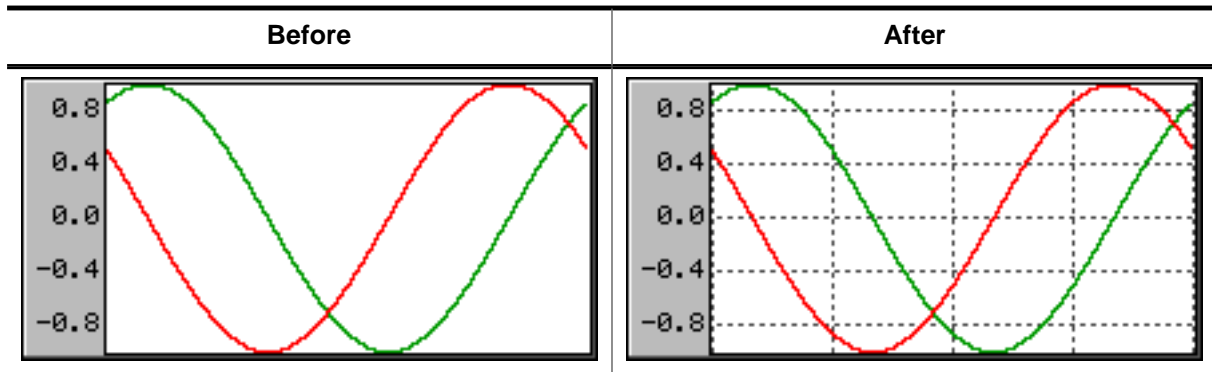

#### Description

Sets the visibility of the grid lines.

#### Prototype

```
unsigned GRAPH_SetGridVis(GRAPH_Handle hObj,
                          unsigned      OnOff);
```

#### Parameters

| Parameter          | Description  |
|--------------------|--|
| <code>hObj</code>  | Handle of GRAPH widget.                              |
| <code>OnOff</code> | 1 if the grid should be visible, 0 if not (default). |

#### Return value

Previous value of the grid visibility.

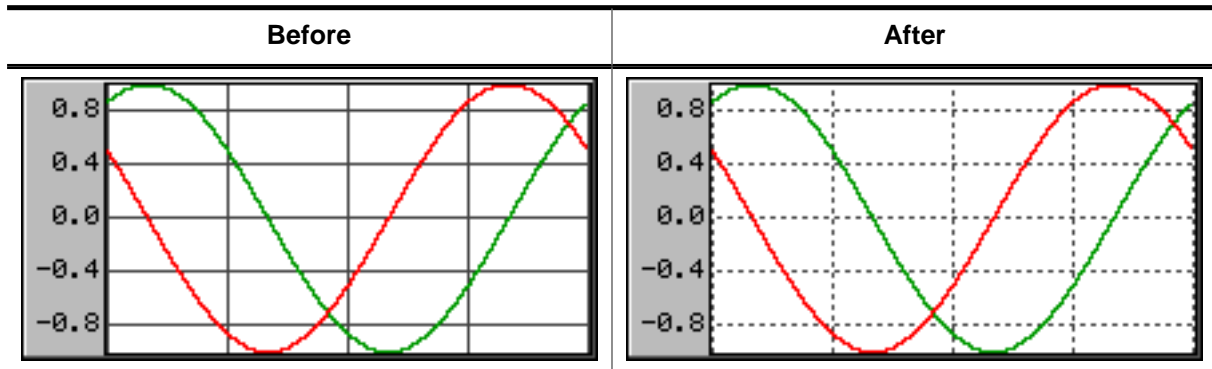
**6.2.11.8.1.21 GRAPH\_SetLineStyleH()****6.2.11.8.1.22 GRAPH\_SetLineStyleV()****Description**

These functions are used to set the line style used to draw the horizontal and vertical grid lines.

**Prototypes**

```
U8 GRAPH_SetLineStyleH(GRAPH_Handle hObj,
                       U8           LineStyle);
```

```
U8 GRAPH_SetLineStyleV(GRAPH_Handle hObj,
                       U8           LineStyle);
```

**Parameters**

| Parameter                 | Description   |
|---------------------------|---|
| <a href="#">hObj</a>      | Handle of GRAPH widget.   |
| <a href="#">LineStyle</a> | Line style to be used. For details about the supported line styles, refer to <a href="#">GUI_SetLineStyle()</a> . |
| <a href="#">Default</a>   | is <a href="#">GUI_LS_SOLID</a> .   |

**Return value**

Previous line style used to draw the horizontal/vertical grid lines.

**Additional information**

Note that using other styles than [GUI\\_LS\\_SOLID](#) will need more time to show the grid.

### 6.2.11.8.1.23 GRAPH\_SetScrollValue()

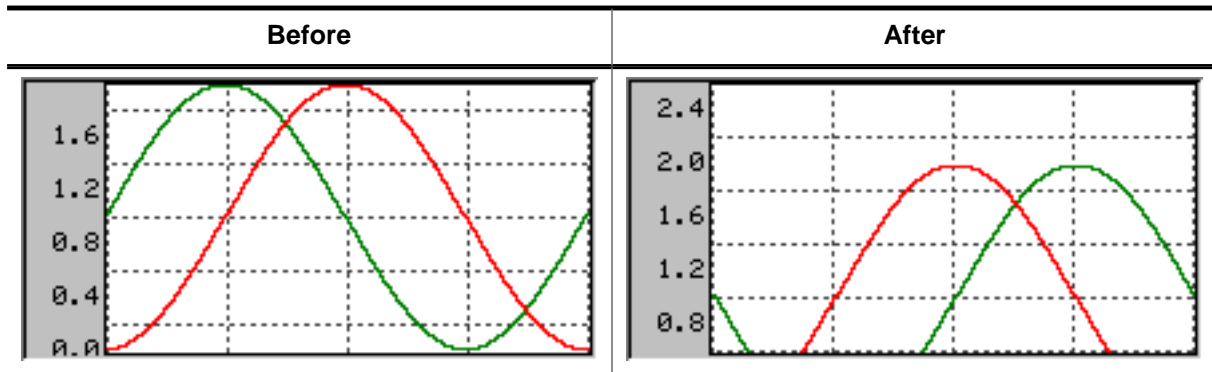

#### Description

Sets the scroll value for the given scroll bar.

#### Prototype

```
void GRAPH_SetScrollValue(GRAPH_Handle hObj,
                          U8          Coord,
                          U32          Value);
```

#### Parameters

| Parameter             | Description             |
|-----------------------|-------------------------|
| <a href="#">hObj</a>  | Handle of GRAPH widget. |
| <a href="#">Coord</a> | See table below.        |
| <a href="#">Value</a> | Scroll value to set.    |

| Permitted values for parameter <a href="#">Coord</a> |                                  |
|--|----------------------------------|
| GUI_COORD_X  | Set the horizontal scroll value. |
| GUI_COORD_Y  | Set the vertical scroll value.   |



#### 6.2.11.8.1.24 GRAPH\_SetUserData()

##### Description

Prototype explained at the beginning of the chapter as `<WIDGET>_SetUserData()` on page 995.

### 6.2.11.8.1.25 GRAPH\_SetUserDraw()

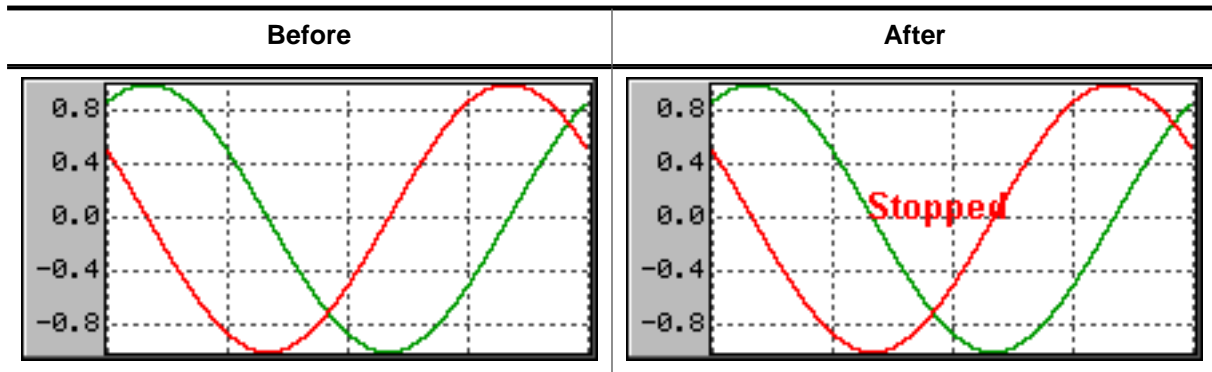

#### Description

Sets the user draw function. This function is called by the widget during the drawing process to give the application the possibility to draw user defined data.

#### Prototype

```
void GRAPH_SetUserDraw(GRAPH_Handle hObj,
                      void          (*pUserDraw)(WM_HWIN , int ));
```

#### Parameters

| Parameter              | Description  |
|------------------------|--|
| <code>hObj</code>      | Handle of GRAPH widget   |
| <code>pUserDraw</code> | Pointer to application function to be called by the widget during the drawing process. |

#### Additional information

The user draw function is called at the beginning after filling the background of the data area and after drawing all GRAPH items like described at the beginning of the chapter. On the first call the clipping region is limited to the data area. On the last call it is limited to the complete GRAPH widget area except the effect frame.

#### Note

The user draw routine is called with a parameter `State`, available values for this parameter are listed under *GRAPH user draw stages* on page 1365.

#### Example

```
static void _UserDraw(WM_HWIN hWin, int Stage) {
    switch (Stage) {
        case GRAPH_DRAW_FIRST:
            //
            // Draw for example a user defined grid...
            //
            break;
        case GRAPH_DRAW_LAST:
            //
            // Draw for example a user defined scale or additional text...
            //
            break;
    }
}

static void _CreateGraph(void) {
    WM_HWIN hGraph;
    hGraph = GRAPH_CreateEx(10, 10, 216, 106, WM_HBKWIN, WM_CF_SHOW, 0, GUI_ID_GRAPH0);
}
```

```
GRAPH_SetUserDraw(hGraph, _UserDraw); // Enable user draw
...
}
```

## 6.2.11.8.1.26 GRAPH\_SetVSizeX()

## 6.2.11.8.1.27 GRAPH\_SetVSizeY()

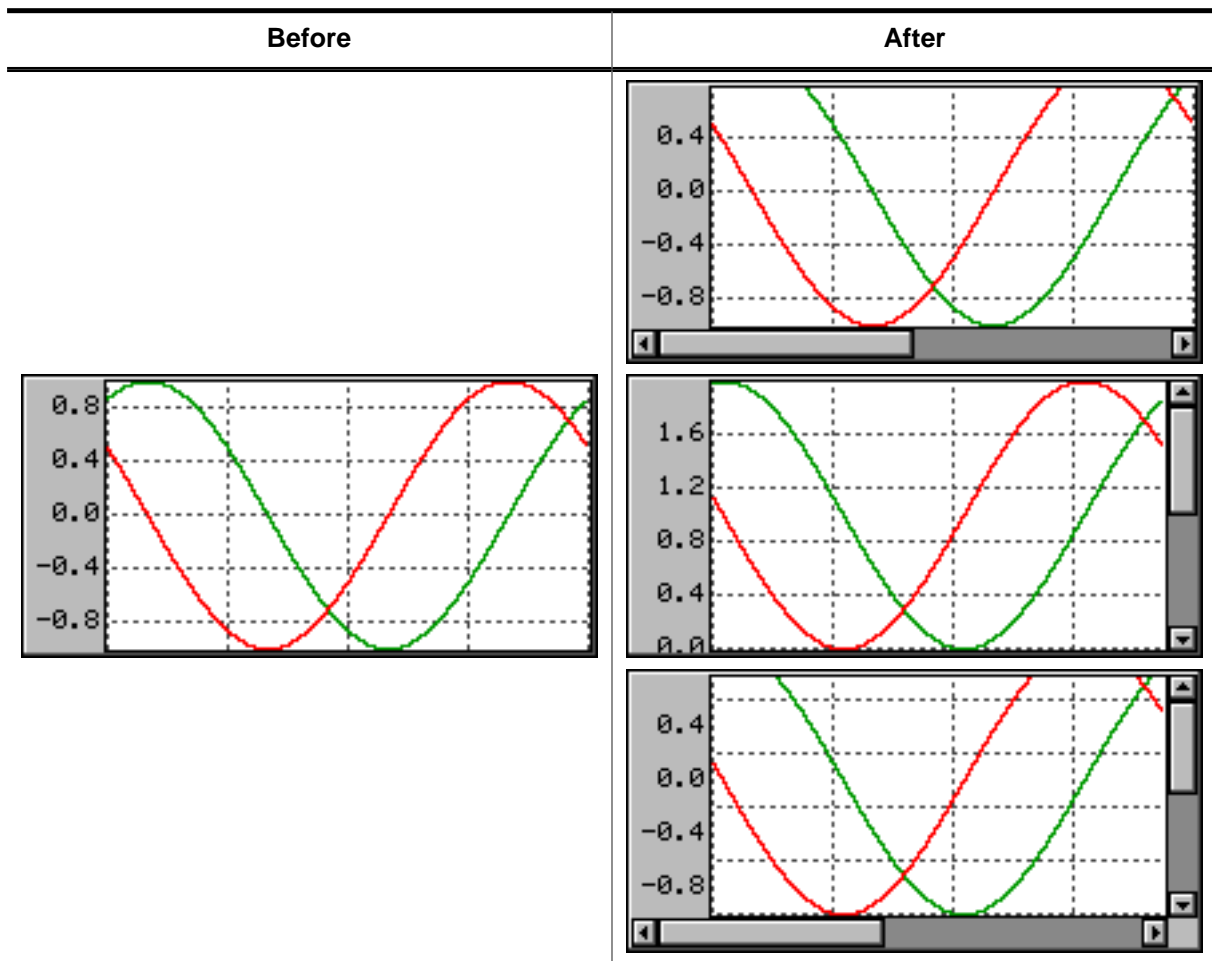

### Description

The functions set the virtual size in X and Y-axis.

### Prototypes

```
unsigned GRAPH_SetVSizeX(GRAPH_Handle hObj,
                        unsigned Value);
```

```
unsigned GRAPH_SetVSizeY(GRAPH_Handle hObj,
                        unsigned Value);
```

### Parameters

| Parameter | Description                            |
|-----------|--|
| hObj      | Handle of GRAPH widget.                |
| Value     | Virtual size in pixels in X or Y axis. |

### Return value

Previous virtual size of the widgets data area in X or Y-axis.

### Additional information

If the widgets virtual size is bigger than the visible size of the data area, the widget automatically shows a scroll bar. If for example a data object, created by the function `GRAPH_DATA_YT_Create()`, contains more data than can be shown in the data area, the function `GRAPH_SetVSizeX()` can be used to enable scrolling. A function call like

`GRAPH_SetVSizeX(NumDataItems)` enables the horizontal scroll bar, provided that the number of data items is bigger than the X-size of the visible data area.

### 6.2.11.8.2 GRAPH\_DATA\_YT related routines

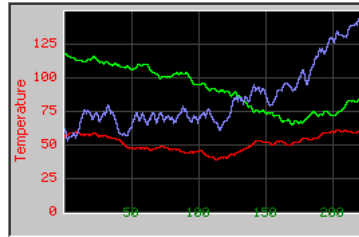

#### 6.2.11.8.2.1 GRAPH\_DATA\_YT\_AddValue()

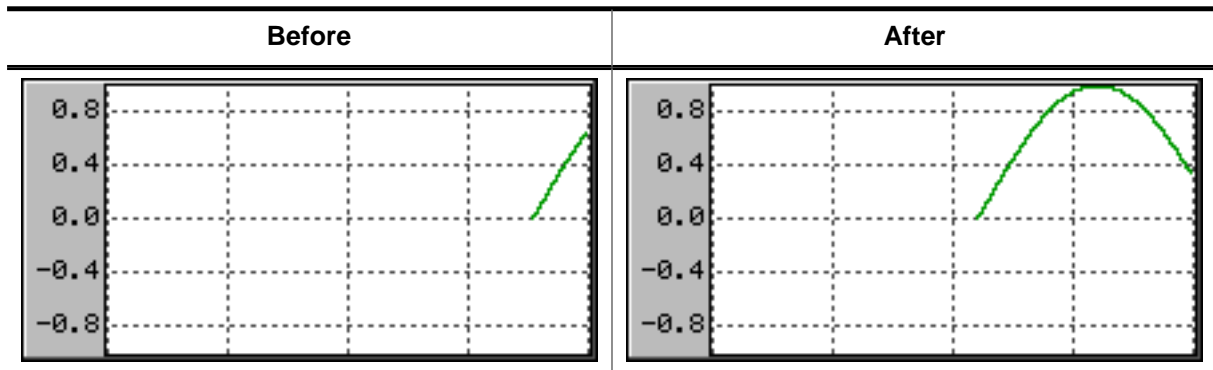

#### Description

Adds a new data item to a GRAPH\_DATA\_YT object.

#### Prototype

```
void GRAPH_DATA_YT_AddValue(GRAPH_DATA_Handle hDataObj,
                             I16 Value);
```

#### Parameters

| Parameter             | Description  |
|-----------------------|--|
| <code>hDataObj</code> | Handle of data object.                             |
| <code>Value</code>    | <code>Value</code> to be added to the data object. |

#### Additional information

The given data value is added to the data object. If the data object is 'full', that means it contains as many data items as specified in parameter `MaxNumItems` during the creation, it first shifts the data items by one before adding the new value. So the first data item is shifted out when adding a data item to a 'full' object. The value `0x7FFF` can be used to handle invalid data values. These values are excluded when drawing the GRAPH. The following screenshot shows a graph with 2 gaps of invalid data:

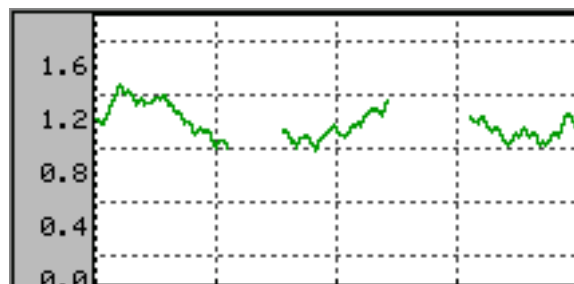

### 6.2.11.8.2.2 GRAPH\_DATA\_YT\_Clear()

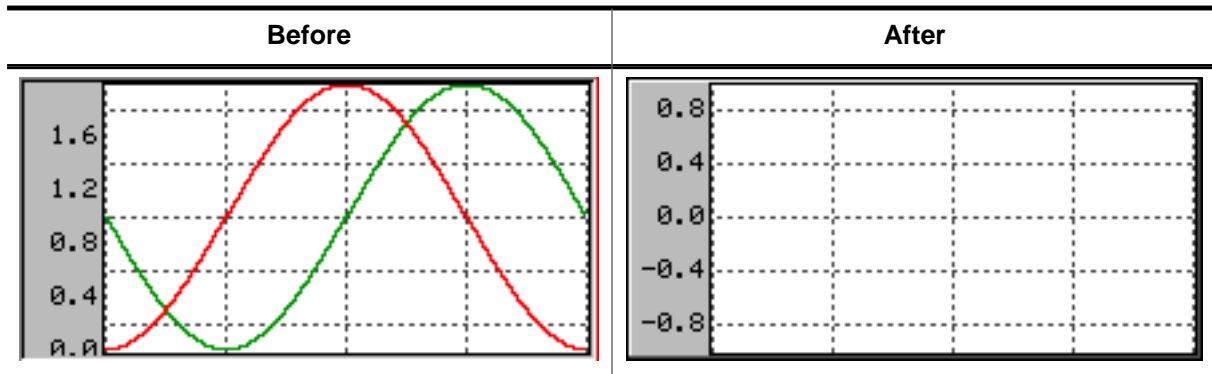

#### Description

Clears all data items of the data object.

#### Prototype

```
void GRAPH_DATA_YT_Clear(GRAPH_DATA_Handle hDataObj);
```

#### Parameters

| Parameter             | Description            |
|-----------------------|------------------------|
| <code>hDataObj</code> | Handle of data object. |

### 6.2.11.8.2.3 GRAPH\_DATA\_YT\_Create()

#### Description

Creates a GRAPH\_DATA\_YT object. This kind of object requires for each point on the x-axis a value on the y-axis. Typically used for time related graphs.

#### Prototype

```
GRAPH_DATA_Handle GRAPH_DATA_YT_Create(      GUI_COLOR   Color,
                                             unsigned    MaxNumItems,
                                             const I16    * pItems,
                                             unsigned    NumItems);
```

#### Parameters

| Parameter   | Description  |
|-------------|--|
| Color       | Color to be used to draw the data.   |
| MaxNumItems | Maximum number of data items.  |
| pItems      | Pointer to data to be added to the object. The pointer should point to an array of I16 values. |
| NumItems    | Number of data items to be added.  |

#### Return value

Handle of data object if creation was successful, otherwise 0.

#### Additional information

The last data item is shown at the rightmost column of the data area. If a data object contains more data as can be shown in the data area of the GRAPH widget, the function GRAPH\_SetVSizeX() can be used to show a scroll bar which makes it possible to scroll through large data objects.

Once attached to a GRAPH widget a data object does not need to be deleted by the application. This is automatically done during the deletion of the GRAPH widget.



#### 6.2.11.8.2.4 GRAPH\_DATA\_YT\_Delete()

##### Description

Deletes the given data object.

##### Prototype

```
void GRAPH_DATA_YT_Delete(GRAPH_DATA_Handle hDataObj);
```

##### Parameters

| Parameter             | Description                          |
|-----------------------|--------------------------------------|
| <code>hDataObj</code> | Handle of data object to be deleted. |

##### Additional information

When a GRAPH widget is deleted it deletes all currently attached data objects. So the application needs only to delete unattached data objects.

### 6.2.11.8.2.5 GRAPH\_DATA\_YT\_GetValue()

#### Description

Returns value for the given index.

#### Prototype

```
int GRAPH_DATA_YT_GetValue(GRAPH_DATA_Handle hDataObj,  
                           I16 * pValue,  
                           U32 Index);
```

#### Parameters

| Parameter                | Description                                   |
|--------------------------|---|
| <a href="#">hDataObj</a> | Handle of data object.                        |
| <a href="#">pValue</a>   | Pointer to a I16 variable.                    |
| <a href="#">Index</a>    | <a href="#">Index</a> of data to be received. |

#### Return value

0 on success.  
1 on error.

### 6.2.11.8.2.6 GRAPH\_DATA\_YT\_MirrorX()

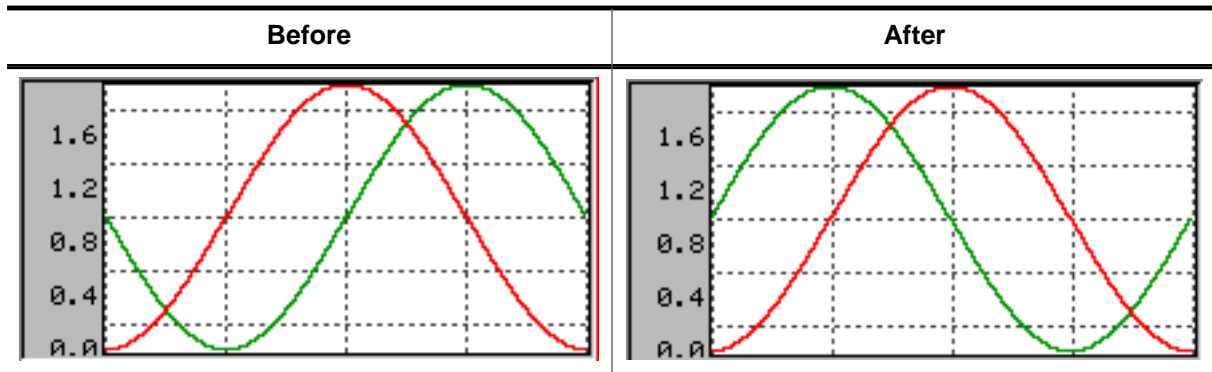

#### Description

Mirrors the x-axis of the widget.

#### Prototype

```
void GRAPH_DATA_YT_MirrorX(GRAPH_DATA_Handle hDataObj,
                           int OnOff);
```

#### Parameters

| Parameter             | Description                                     |
|-----------------------|---|
| <code>hDataObj</code> | Handle of data object.                          |
| <code>OnOff</code>    | 1 for mirroring the x-axis, 0 for default view. |

#### Additional information

Per default the data is drawn from the right to the left. After calling this function the data is drawn from the left to the right.

### 6.2.11.8.2.7 GRAPH\_DATA\_YT\_SetAlign()

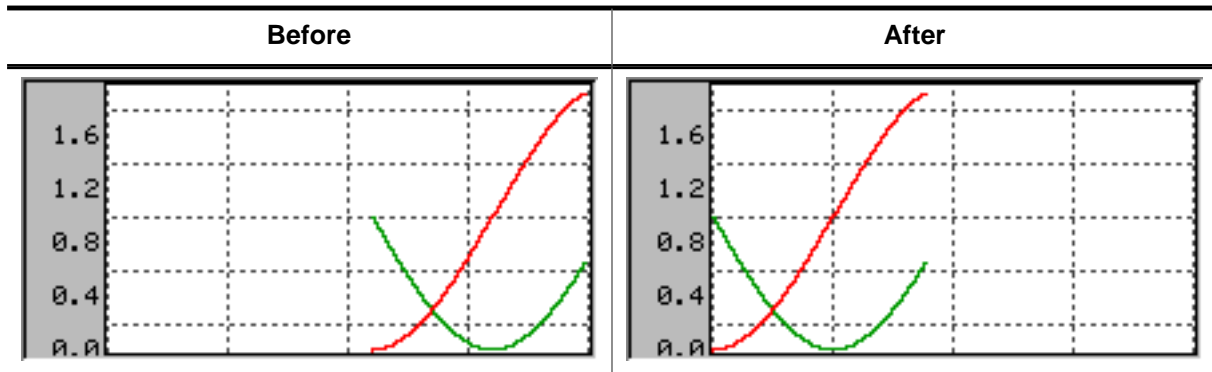

#### Description

Sets the alignment of the data.

#### Prototype

```
void GRAPH_DATA_YT_SetAlign(GRAPH_DATA_Handle hDataObj,
                             int Align);
```

#### Parameters

| Parameter             | Description   |
|-----------------------|---|
| <code>hDataObj</code> | Handle of data object.  |
| <code>Align</code>    | Alignment of the data. See <i>GRAPH alignment flags</i> on page 1362. |

### 6.2.11.8.2.8 GRAPH\_DATA\_YT\_SetColor()

#### Description

This function sets a color for the given data object.

#### Prototype

```
GUI_COLOR GRAPH_DATA_YT_SetColor(GRAPH_DATA_Handle hDataObj,  
                                  GUI_COLOR          Color);
```

#### Parameters

| Parameter             | Description                   |
|-----------------------|-------------------------------|
| <code>hDataObj</code> | Handle to data object.        |
| <code>Color</code>    | <code>Color</code> to be set. |

### 6.2.11.8.2.9 GRAPH\_DATA\_YT\_SetOffY()

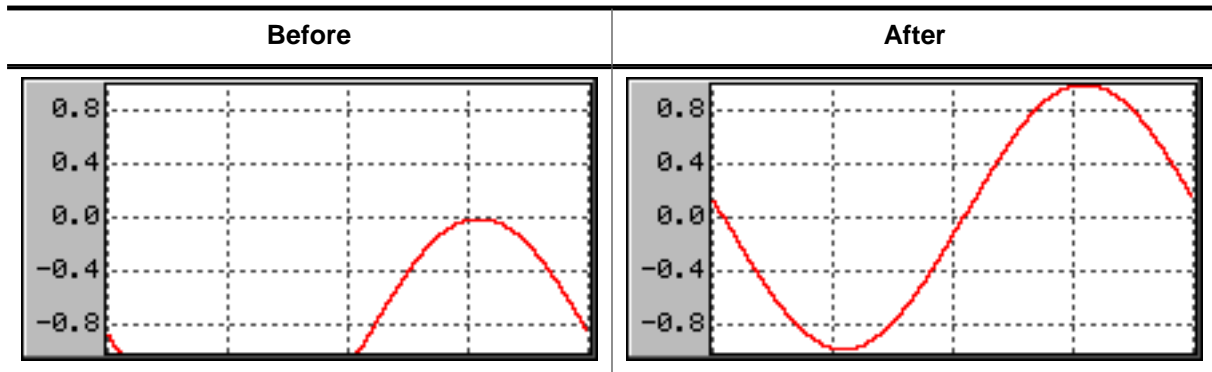

#### Description

Sets a vertical offset used to draw the object data.

#### Prototype

```
void GRAPH_DATA_YT_SetOffY(GRAPH_DATA_Handle hDataObj,
                           int Off);
```

#### Parameters

| Parameter             | Description  |
|-----------------------|--|
| <code>hDataObj</code> | Handle of data object.                                 |
| <code>Off</code>      | Vertical offset which should be used to draw the data. |

#### Additional information

The vertical range of data, which is shown by the data object, is the range (0) - (Y-size of data area - 1). In case of using a scroll bar the current scroll position is added to the range.

#### Example

If for example the visible data range should be -200 to -100 the data needs to be shifted in positive direction by 200 pixels:

```
GRAPH_DATA_YT_SetOffY(hDataObj, 200);
```

### 6.2.11.8.3 GRAPH\_DATA\_XY related routines

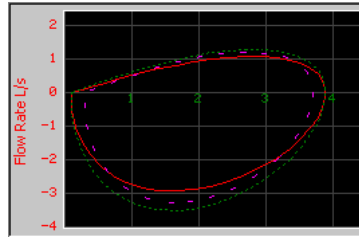

#### 6.2.11.8.3.1 GRAPH\_DATA\_XY\_AddPoint()

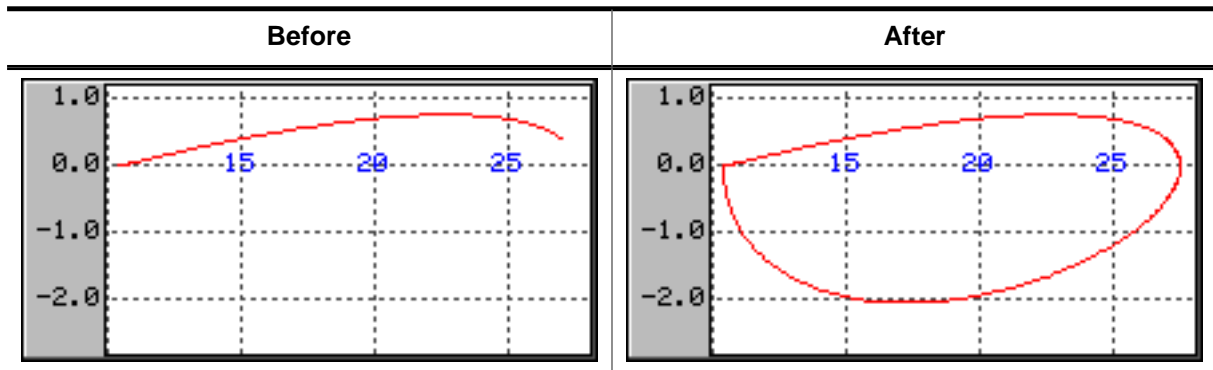

#### Description

Adds a new data item to a GRAPH\_DATA\_XY object.

#### Prototype

```
void GRAPH_DATA_XY_AddPoint(GRAPH_DATA_Handle hDataObj,
                             GUI_POINT * pPoint);
```

#### Parameters

| Parameter             | Description  |
|-----------------------|--|
| <code>hDataObj</code> | Handle of data object.   |
| <code>pPoint</code>   | Pointer to a GUI_POINT structure to be added to the data object. |

#### Additional information

The given point is added to the data object. If the data object is 'full', that means it contains as many points as specified in parameter `MaxNumItems` during the creation, it first shifts the data items by one before adding the new point. So the first point is shifted out when adding a new point to a 'full' object.

### 6.2.11.8.3.2 GRAPH\_DATA\_XY\_Clear()

#### Description

Clears all data items of the data object.

#### Prototype

```
void GRAPH_DATA_XY_Clear(GRAPH_DATA_Handle hDataObj);
```

#### Parameters

| Parameter                | Description            |
|--------------------------|------------------------|
| <a href="#">hDataObj</a> | Handle of data object. |



### 6.2.11.8.3.3 GRAPH\_DATA\_XY\_Create()

#### Description

Creates a GRAPH\_DATA\_XY object. This kind of object is able to store any pairs of values which will be connected by adding order.

#### Prototype

```
GRAPH_DATA_Handle GRAPH_DATA_XY_Create(      GUI_COLOR    Color,
                                             unsigned      MaxNumItems,
                                             const GUI_POINT * pItems,
                                             unsigned      NumItems);
```

#### Parameters

| Parameter   | Description   |
|-------------|---|
| Color       | Color to be used to draw the data.  |
| MaxNumItems | Maximum number of points.   |
| pData       | Pointer to data to be added to the object. The pointer should point to a GUI_POINT array. |
| NumItems    | Number of points to be added.   |

#### Return value

Handle of data object if creation was successful, otherwise 0.

#### Additional information

Once attached to a GRAPH widget a data object does not need to be deleted by the application. This is automatically done during the deletion of the GRAPH widget.

#### 6.2.11.8.3.4 GRAPH\_DATA\_XY\_Delete()

##### Description

Deletes the given data object.

##### Prototype

```
void GRAPH_DATA_XY_Delete(GRAPH_DATA_Handle hDataObj);
```

##### Parameters

| Parameter                | Description                |
|--------------------------|----------------------------|
| <a href="#">hDataObj</a> | Data object to be deleted. |

##### Additional information

When a GRAPH widget is deleted it deletes all currently attached data objects. So the application needs only to delete unattached data objects.

### 6.2.11.8.3.5 GRAPH\_DATA\_XY\_GetLineVis()

#### Description

Returns if the line of the data object is visible.

#### Prototype

```
unsigned GRAPH_DATA_XY_GetLineVis(GRAPH_DATA_Handle hDataObj);
```

#### Parameters

| Parameter                | Description            |
|--------------------------|------------------------|
| <a href="#">hDataObj</a> | Handle of data object. |

#### Return value

- 0 Line is not visible.
- 1 Line is visible.

### 6.2.11.8.3.6 GRAPH\_DATA\_XY\_GetPoint()

#### Description

Returns a point for the given index.

#### Prototype

```
int GRAPH_DATA_XY_GetPoint(GRAPH_DATA_Handle  hDataObj,
                           GUI_POINT        * pPoint,
                           U32              Index);
```

#### Parameters

| Parameter                | Description                                   |
|--------------------------|---|
| <a href="#">hDataObj</a> | Handle of data object.                        |
| <a href="#">pPoint</a>   | Pointer to a GUI_POINT structure.             |
| <a href="#">Index</a>    | <a href="#">Index</a> of data to be received. |

#### Return value

0        on success.  
1        on error.

### 6.2.11.8.3.7 GRAPH\_DATA\_XY\_GetPointVis()

#### Description

Returns if the points of a data object have been made visible.

#### Prototype

```
unsigned GRAPH_DATA_XY_GetPointVis(GRAPH_DATA_Handle hDataObj);
```

#### Parameters

| Parameter                | Description            |
|--------------------------|------------------------|
| <a href="#">hDataObj</a> | Handle of data object. |

#### Return value

- 0 Points are not made visible.
- 1 Points are made visible.

### 6.2.11.8.3.8 GRAPH\_DATA\_XY\_SetColor()

#### Description

This function sets a color for the given data object.

#### Prototype

```
GUI_COLOR GRAPH_DATA_XY_SetColor(GRAPH_DATA_Handle hDataObj,  
                                  GUI_COLOR          Color);
```

#### Parameters

| Parameter             | Description                   |
|-----------------------|-------------------------------|
| <code>hDataObj</code> | Handle of data object.        |
| <code>Color</code>    | <code>Color</code> to be set. |

### 6.2.11.8.3.9 GRAPH\_DATA\_XY\_SetLineStyle()

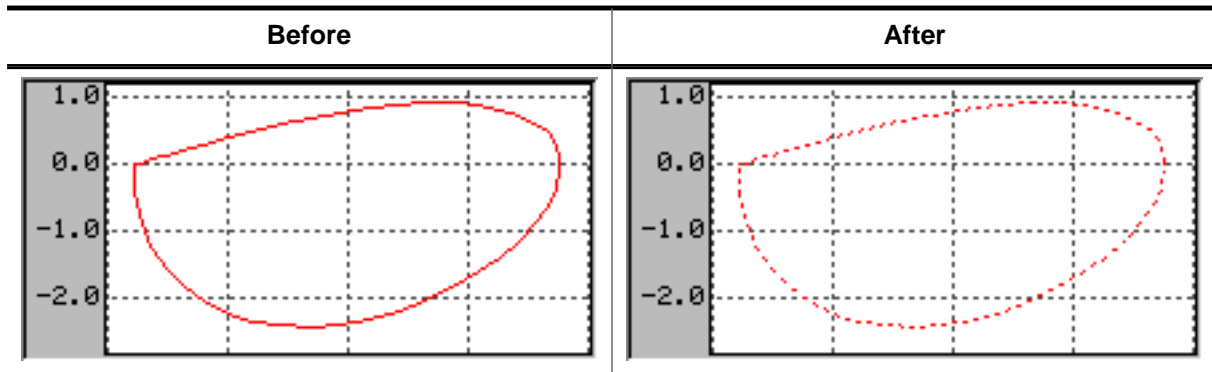

#### Description

Sets the line style used to draw the polyline.

#### Prototype

```
void GRAPH_DATA_XY_SetLineStyle(GRAPH_DATA_Handle hDataObj,
                                U8 LineStyle);
```

#### Parameters

| Parameter              | Description   |
|------------------------|---|
| <code>hDataObj</code>  | Handle of data object.  |
| <code>LineStyle</code> | New line style to be used. For details about the supported line styles refer to <code>GUI_SetLineStyle()</code> . |

#### Limitations

Note that only curves with line style `GUI_LS_SOLID` (default) can be drawn with a pen size > 1.

### 6.2.11.8.3.10 GRAPH\_DATA\_XY\_SetLineVis()

#### Description

Sets the visibility of the data object's line.

#### Prototype

```
unsigned GRAPH_DATA_XY_SetLineVis(GRAPH_DATA_Handle hDataObj,  
                                  unsigned          OnOff);
```

#### Parameters

| Parameter             | Description   |
|-----------------------|---|
| <code>hDataObj</code> | Handle of data object.                                  |
| <code>OnOff</code>    | 1 to make the line visible, 0 to clear visibility flag. |

#### Return value

- 0 If line was not previously visible.
- 1 If line was previously visible.



## 6.2.11.8.3.11 GRAPH\_DATA\_XY\_SetOffX()

## 6.2.11.8.3.12 GRAPH\_DATA\_XY\_SetOffY()

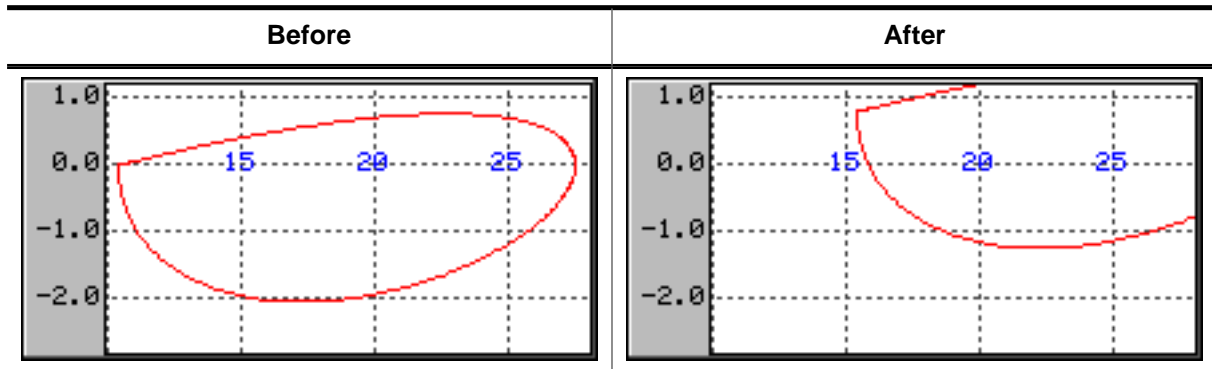

### Description

Sets a vertical or horizontal offset used to draw the polyline.

### Prototypes

```
void GRAPH_DATA_XY_SetOffX(GRAPH_DATA_Handle hDataObj,
                           int Off);
```

```
void GRAPH_DATA_XY_SetOffY(GRAPH_DATA_Handle hDataObj,
                           int Off);
```

### Parameters

| Parameter             | Description   |
|-----------------------|---|
| <code>hDataObj</code> | Handle of data object.  |
| <code>Off</code>      | Horizontal/vertical offset which should be used to draw the polyline. |

### Additional information

The range of data shown by the data object is (0, 0) - (X-size of data area - 1, Y-size of data area - 1). In case of using scroll bars the current scroll position is added to the respective range. To make other ranges of data visible this functions should be used to set an offset, so that the data is in the visible area.

### Example

If for example the visible data range should be (100, -1200) - (200, -1100) the following offsets need to be used:

```
GRAPH_DATA_XY_SetOffX(hDataObj, -100);
GRAPH_DATA_XY_SetOffY(hDataObj, 1200);
```

### 6.2.11.8.3.13 GRAPH\_DATA\_XY\_SetOwnerDraw()

#### Description

Sets the owner callback function. This function is called by the widget during the drawing process to give the application the possibility to draw additional items on top of the widget.

#### Prototype

```
void GRAPH_DATA_XY_SetOwnerDraw(GRAPH_DATA_Handle      hDataObj,
                                WIDGET_DRAW_ITEM_FUNC * pfOwnerDraw);
```

#### Parameters

| Parameter             | Description                   |
|-----------------------|-------------------------------|
| <code>hDataObj</code> | Handle of data object.        |
| <code>Color</code>    | <code>Color</code> to be set. |

#### Supported commands

- WIDGET\_ITEM\_DRAW

#### Additional information

The owner draw function is called after background, scales and grid lines are drawn.

#### Example

The following code snippet shows an example of an user draw function:

```
static int _cbData(const WIDGET_ITEM_DRAW_INFO * pDrawItemInfo) {
    switch (pDrawItemInfo->Cmd) {
        case WIDGET_ITEM_DRAW:
            GUI_DrawRect(pDrawItemInfo->x0 - 3, pDrawItemInfo->y0 - 3,
                        pDrawItemInfo->x0 + 3, pDrawItemInfo->y0 + 3);
            break;
    }
    return 0;
}

void MainTask(void) {
    WM_HWIN      hGraph;
    GRAPH_DATA_Handle hData;
    GUI_Init();
    hGraph = GRAPH_CreateEx (140, 100, 171, 131, 0, WM_CF_SHOW, 0, GUI_ID_GRAPH0);
    hData = GRAPH_DATA_XY_Create(USER_DEFINED_COLOR, 126, 0, 0);
    GRAPH_DATA_XY_SetOwnerDraw(hData, _cbData);
}
```

### 6.2.11.8.3.14 GRAPH\_DATA\_XY\_SetPenSize()

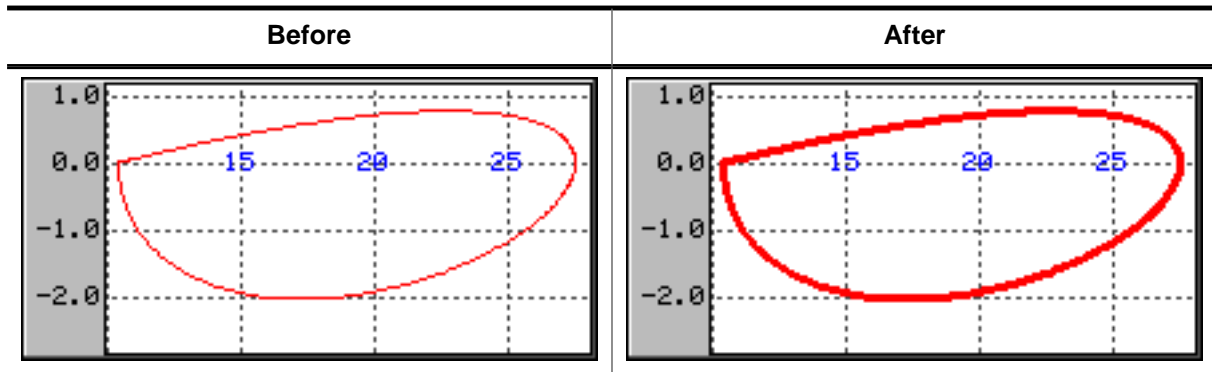

#### Description

Sets the pen size used to draw the polyline.

#### Prototype

```
void GRAPH_DATA_XY_SetPenSize(GRAPH_DATA_Handle hDataObj,
                              U8 PenSize);
```

#### Parameters

| Parameter             | Description   |
|-----------------------|---|
| <code>hDataObj</code> | Handle of data object.                              |
| <code>PenSize</code>  | Pen size which should be used to draw the polyline. |

#### Limitations

Note that only curves with line style `GUI_LS_SOLID` (default) can be drawn with a pen size > 1.

### 6.2.11.8.3.15 GRAPH\_DATA\_XY\_SetPointVis()

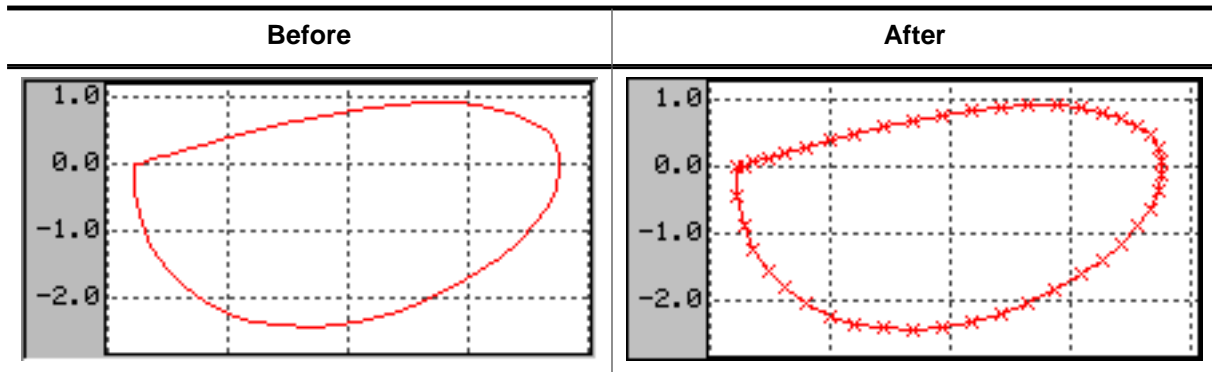

#### Description

Makes all points of a data object visible. Each point has a small marking.

#### Prototype

```
unsigned GRAPH_DATA_XY_SetPointVis(GRAPH_DATA_Handle hDataObj,
                                   unsigned           OnOff);
```

#### Parameters

| Parameter             | Description  |
|-----------------------|--|
| <code>hDataObj</code> | Handle of data object.                                 |
| <code>OnOff</code>    | 1 to make all points visible, 0 to just show the line. |

#### Return value

- 0 If points were not previously visible.
- 1 If points were previously visible.

### 6.2.11.8.4 Scale related routines

The GRAPH widget supports horizontal and vertical scales for labeling purpose. The following describes the available functions for using scales.

#### 6.2.11.8.4.1 GRAPH\_SCALE\_Create()

##### Description

Creates a GRAPH\_SCALE object.

##### Prototype

```
GRAPH_SCALE_Handle GRAPH_SCALE_Create(int Pos,
                                     int TextAlign,
                                     unsigned Flags,
                                     unsigned TickDist);
```

##### Parameters

| Parameter                 | Description   |
|---------------------------|---|
| <a href="#">Pos</a>       | Position relative to the left/top edge of the GRAPH widget.                           |
| <a href="#">TextAlign</a> | Text alignment used to draw the numbers. See <i>Text alignment flags</i> on page 252. |
| <a href="#">Flags</a>     | See <i>SCALE create flags</i> on page 1366.   |
| <a href="#">TickDist</a>  | Distance from one tick mark to the next.  |

##### Return value

Handle of the scale object if creation was successful, otherwise 0.

##### Additional information

A horizontal scale object starts labeling from the bottom edge of the data area to the top and a vertical scale object from the left edge (horizontal scale) to the right, where the first position is the zero point. The parameter [TickDist](#) specifies the distance between the numbers.

The parameter [Pos](#) specifies in case of a horizontal scale the vertical distance in pixels from the top edge of the GRAPH widget to the scale text. In case of a vertical scale the parameter specifies the horizontal distance from the left edge of the GRAPH widget to the horizontal text position. Note that the actual text position also depends on the text alignment specified with parameter [TextAlign](#).

The scale object draws a number for each position which is within the data area. In case of a horizontal scale there is one exception: If the first position is 0 no number is drawn at this position.

Once attached to a GRAPH widget a scale object does not need to be deleted by the application. This is automatically done during the deletion of the GRAPH widget.

#### 6.2.11.8.4.2 GRAPH\_SCALE\_Delete()

##### Description

Deletes the given scale object.

##### Prototype

```
void GRAPH_SCALE_Delete(GRAPH_SCALE_Handle hScaleObj);
```

##### Parameters

| Parameter                 | Description                           |
|---------------------------|---------------------------------------|
| <a href="#">hScaleObj</a> | Handle of scale object to be deleted. |

##### Additional information

When a GRAPH widget is deleted it deletes all currently attached scale objects. So the application needs only to delete unattached scale objects.

### 6.2.11.8.4.3 GRAPH\_SCALE\_SetFactor()

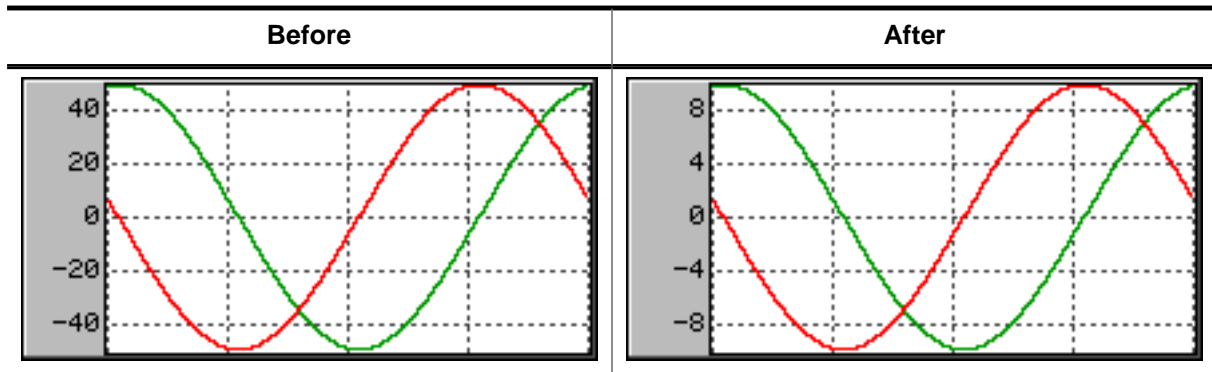

#### Description

Sets a factor used to calculate the numbers to be drawn.

#### Prototype

```
float GRAPH_SCALE_SetFactor(GRAPH_SCALE_Handle hScaleObj,
                           float Factor);
```

#### Parameters

| Parameter              | Description   |
|------------------------|---|
| <code>hScaleObj</code> | Handle of scale object.                                 |
| <code>Factor</code>    | <code>Factor</code> to be used to calculate the number. |

#### Return value

Old factor used to calculate the numbers.

#### Additional information

Without using a factor the unit of the scale object is 'pixel'. So the given factor should convert the pixel value to the desired unit.

#### 6.2.11.8.4.4 GRAPH\_SCALE\_SetFont()

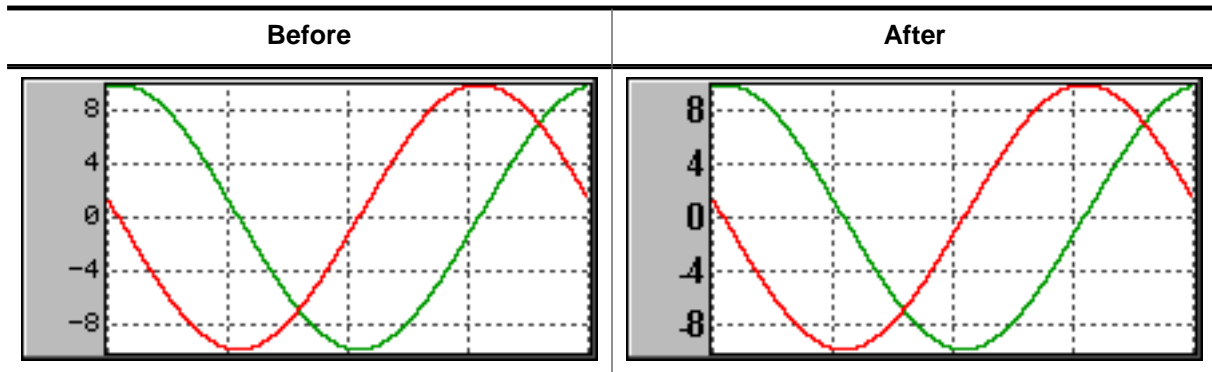

#### Description

Sets the font used to draw the scale numbers.

#### Prototype

```
GUI_FONT *GRAPH_SCALE_SetFont(    GRAPH_SCALE_Handle  hScaleObj,
                                const GUI_FONT          * pFont);
```

#### Parameters

| Parameter              | Description             |
|------------------------|-------------------------|
| <code>hScaleObj</code> | Handle of scale object. |
| <code>pFont</code>     | Font to be used.        |

#### Return value

Previous used font used to draw the numbers.



#### 6.2.11.8.4.5 GRAPH\_SCALE\_SetNumDecs()

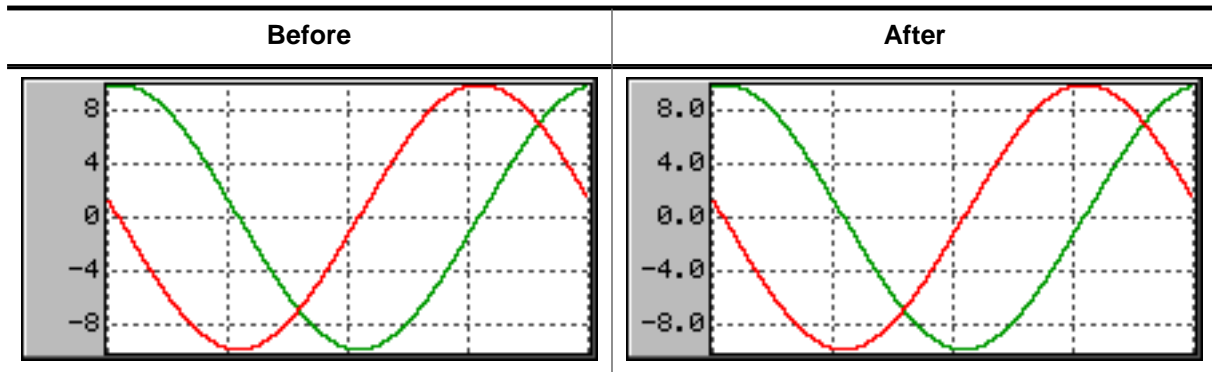

#### Description

Sets the number of post decimal positions to be shown.

#### Prototype

```
int GRAPH_SCALE_SetNumDecs(GRAPH_SCALE_Handle hScaleObj,
                           int NumDecs);
```

#### Parameters

| Parameter              | Description                       |
|------------------------|-----------------------------------|
| <code>hScaleObj</code> | Handle of scale object.           |
| <code>NumDecs</code>   | Number of post decimal positions. |

#### Return value

Previous number of post decimal positions.

#### 6.2.11.8.4.6 GRAPH\_SCALE\_SetOff()

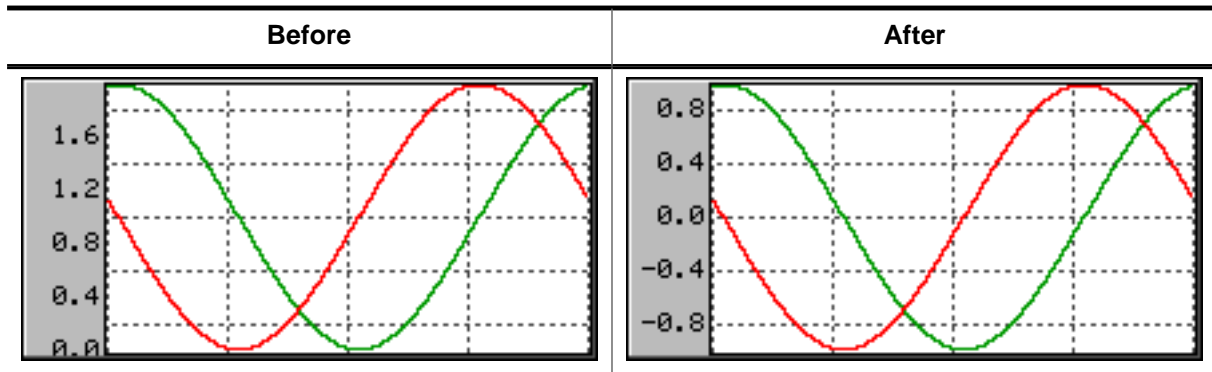

### Description

Sets an offset used to 'shift' the scale object in positive or negative direction.

### Prototype

```
int GRAPH_SCALE_SetOff(GRAPH_SCALE_Handle hScaleObj,
                      int Off);
```

### Parameters

| Parameter              | Description                        |
|------------------------|------------------------------------|
| <code>hScaleObj</code> | Handle of scale object.            |
| <code>Off</code>       | Offset used for drawing the scale. |

### Return value

Previous used offset.

### Additional information

As described under the function `GRAPH_SCALE_Create()` a horizontal scale object starts labeling from the bottom edge of the data area to the top and a vertical scale object from the left edge (horizontal scale) to the right, where the first position is the zero point. In many situations it is not desirable, that the first position is the zero point. If the scale should be 'shifted' in positive direction, a positive offset should be added, for negative direction a negative value.

### 6.2.11.8.4.7 GRAPH\_SCALE\_SetPos()

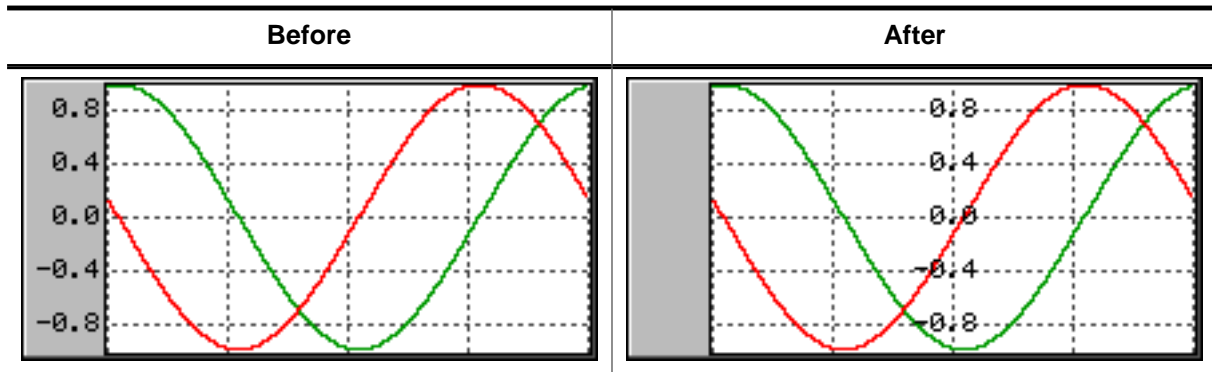

#### Description

Sets the position for showing the scale object within the GRAPH widget.

#### Prototype

```
int GRAPH_SCALE_SetPos(GRAPH_SCALE_Handle hScaleObj,
                       int Pos);
```

#### Parameters

| Parameter              | Description                                   |
|------------------------|---|
| <code>hScaleObj</code> | Handle of scale object.                       |
| <code>Pos</code>       | Position, at which the scale should be shown. |

#### Return value

Previous position of the scale object.

#### Additional information

The parameter `Pos` specifies in case of a horizontal scale the vertical distance in pixels from the top edge of the GRAPH widget to the scale text. In case of a vertical scale the parameter specifies the horizontal distance from the left edge of the GRAPH widget to the horizontal text position. Note that the actual text position also depends on the text alignment of the scale object.

#### 6.2.11.8.4.8 GRAPH\_SCALE\_SetTextColor()

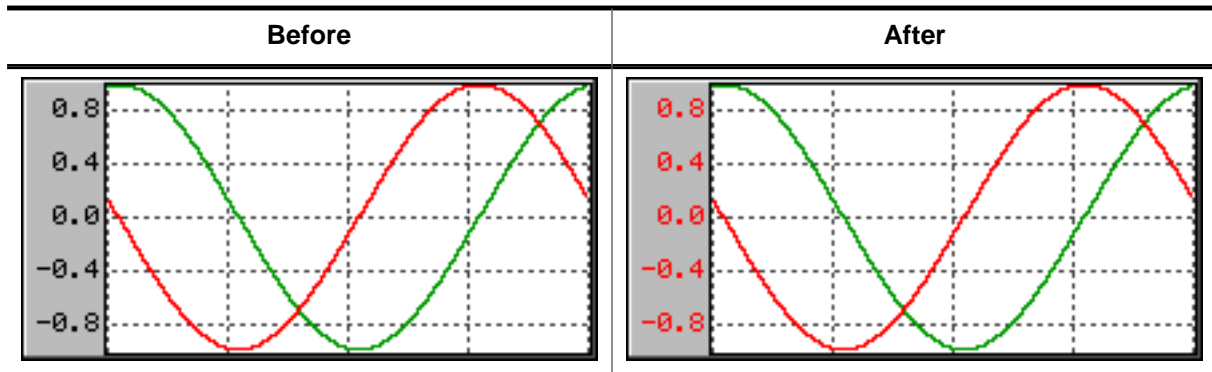

### Description

Sets the text color used to draw the numbers.

### Prototype

```
GUI_COLOR GRAPH_SCALE_SetTextColor(GRAPH_SCALE_Handle hScaleObj,
                                   GUI_COLOR          Color);
```

### Parameters

| Parameter              | Description  |
|------------------------|--|
| <code>hScaleObj</code> | Handle of scale object.                            |
| <code>Color</code>     | <code>Color</code> to be used to show the numbers. |

### Return value

Previous color used to show the numbers.

### 6.2.11.8.4.9 GRAPH\_SCALE\_SetTickDist()

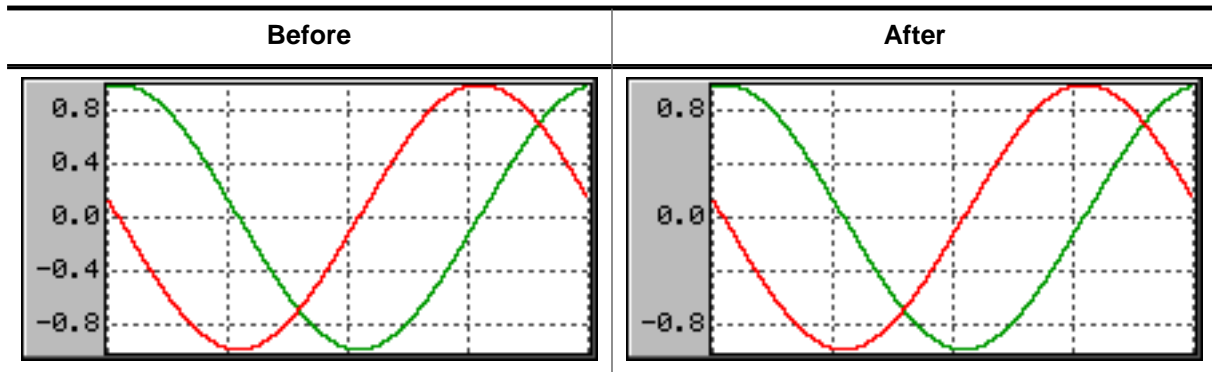

#### Description

Sets the distance from one number to the next.

#### Prototype

```
unsigned GRAPH_SCALE_SetTickDist(GRAPH_SCALE_Handle hScaleObj,
                                unsigned Value);
```

#### Parameters

| Parameter              | Description                             |
|------------------------|---|
| <code>hScaleObj</code> | Handle of scale object.                 |
| <code>Dist</code>      | Distance in pixels between the numbers. |

#### Return value

Previous distance between the numbers.

## 6.2.11.8.5 Defines

### 6.2.11.8.5.1 GRAPH alignment flags

#### Description

Flags that define the alignment of the data of a graph.

#### Definition

```
#define GRAPH_ALIGN_RIGHT    (0 << 0)
#define GRAPH_ALIGN_LEFT    (1 << 0)
```

#### Symbols

| Definition                        | Description                                      |
|-----------------------------------|--|
| <a href="#">GRAPH_ALIGN_RIGHT</a> | The data is aligned at the right edge (default). |
| <a href="#">GRAPH_ALIGN_LEFT</a>  | The data is aligned at the left edge.            |

### 6.2.11.8.5.2 GRAPH color indexes

#### Description

Color indexes used by the GRAPH widget.

#### Definition

```
#define GRAPH_CI_BK          0
#define GRAPH_CI_BORDER    1
#define GRAPH_CI_FRAME     2
#define GRAPH_CI_GRID      3
```

#### Symbols

| Definition                      | Description                   |
|---------------------------------|-------------------------------|
| <a href="#">GRAPH_CI_BK</a>     | Background color.             |
| <a href="#">GRAPH_CI_BORDER</a> | Color of the border area.     |
| <a href="#">GRAPH_CI_FRAME</a>  | Color of the thin frame line. |
| <a href="#">GRAPH_CI_GRID</a>   | Color of the grid.            |

### 6.2.11.8.5.3 GRAPH create flags

#### Description

Create flags used for GRAPH objects.

#### Definition

```
#define GRAPH_CF_GRID_FIXED_X      (1 << 0)
#define GRAPH_CF_AVOID_SCROLLBAR_H (1 << 1)
#define GRAPH_CF_AVOID_SCROLLBAR_V (1 << 2)
```

#### Symbols

| Definition                                 | Description   |
|--|---|
| <a href="#">GRAPH_CF_GRID_FIXED_X</a>      | This flag 'fixes' the grid in X-axis. That means if horizontal scrolling is used, the grid remains in its position. |
| <a href="#">GRAPH_CF_AVOID_SCROLLBAR_H</a> | Automatic use of a horizontal scrollbar is disabled. (Default).   |
| <a href="#">GRAPH_CF_AVOID_SCROLLBAR_V</a> | Automatic use of a vertical scrollbar is disabled. (Default).   |



#### 6.2.11.8.5.4 GRAPH user draw stages

##### Description

Stages sent to a user draw routine with the `Stage` parameter. For more information, refer to `GRAPH_SetUserDraw()`.

##### Definition

```
#define GRAPH_DRAW_FIRST          0
#define GRAPH_DRAW_AFTER_BORDER  1
#define GRAPH_DRAW_LAST          2
```

##### Symbols

| Definition                           | Description  |
|--------------------------------------|--|
| <code>GRAPH_DRAW_FIRST</code>        | Gives the application the possibility to perform drawing operations at the beginning of the drawing process. |
| <code>GRAPH_DRAW_AFTER_BORDER</code> | Gives the application the possibility to perform drawing operations after the border was drawn.              |
| <code>GRAPH_DRAW_LAST</code>         | Performs final drawing operations.   |

### 6.2.11.8.5.5 SCALE create flags

#### Description

Create flags used for scale objects.

#### Definition

```
#define GRAPH_SCALE_CF_HORIZONTAL (0 << 0)
#define GRAPH_SCALE_CF_VERTICAL (1 << 0)
```

#### Symbols

| Definition                                | Description                        |
|---|------------------------------------|
| <a href="#">GRAPH_SCALE_CF_HORIZONTAL</a> | Creates a horizontal scale object. |
| <a href="#">GRAPH_SCALE_CF_VERTICAL</a>   | Creates a vertical scale object.   |

### 6.2.11.9 Examples

The `Sample` folder contains the following examples which show how the widget can be used:

- `WIDGET_GraphXY.c`
- `WIDGET_GraphYT.c`

Note that several other examples also make use of this widget and may also be helpful to get familiar with the widget.

#### Screenshot of `WIDGET_GraphXY.c`:

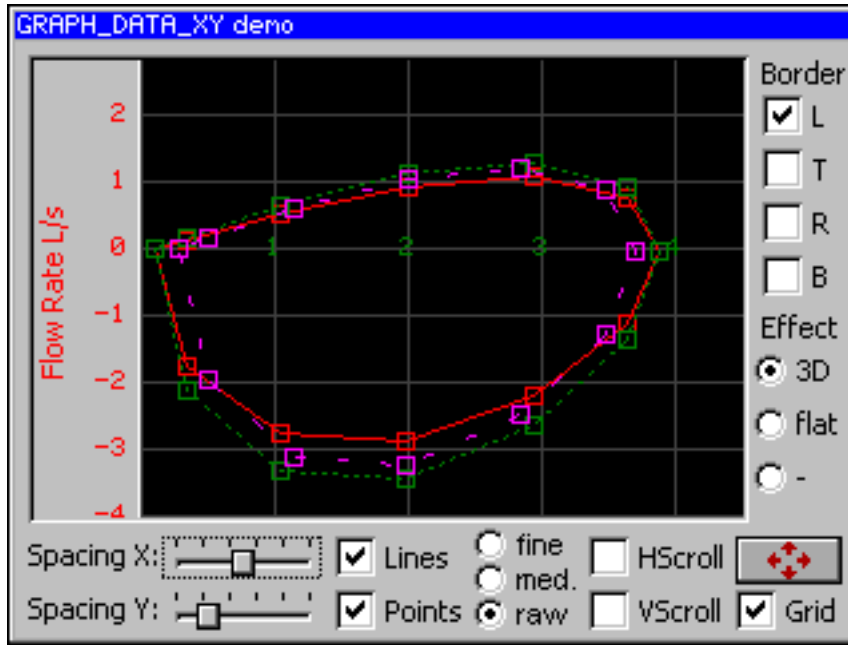

#### Screenshot of `WIDGET_GraphYT.c`:

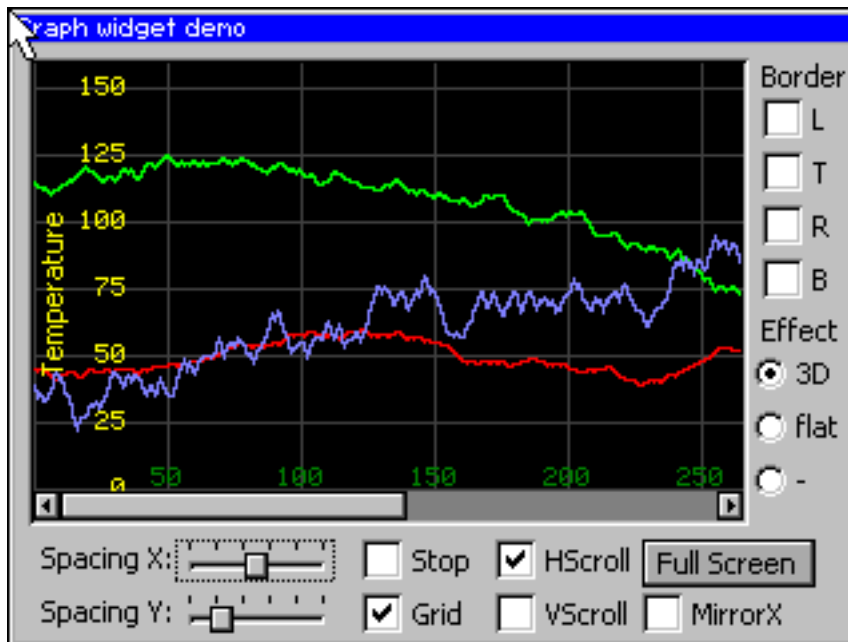

## 6.2.12 HEADER: Header widget

HEADER widgets are used to label columns of a table:



### Note

All HEADER-related routines are located in the file(s) `HEADER*.c`, `HEADER.h`.  
All identifiers are prefixed `HEADER`.

If a pointer input device (PID) is used, the width of the HEADER items can be managed by dragging the dividers by the PID.

### Behavior with mouse

If mouse support is enabled, the cursor is on and the PID is moved nearby a divider the cursor will change to signal, that the divider can be dragged at the current position.

### Behavior with touch screen

If the widget is pressed nearby a divider and the cursor is on the cursor will change to signal, that the divider can now be dragged.

### Screenshot of drag-able divider



### Predefined cursors

There are 2 predefined cursors as shown below:

| GUI_CursorHeaderM (default) | GUI_CursorHeaderMI |
|-----------------------------|--------------------|
|                             |                    |

You can also create and use your own cursors when using a HEADER widget as described later in this chapter.

### Skinning...



...is available for this widget. The screenshot above shows the widget using the default skin. Details can be found in the chapter *Skinning* on page 2509.

### 6.2.12.1 Configuration options

| Type | Macro                   | Default            | Description                               |
|------|-------------------------|--------------------|---|
| N    | HEADER_BKCOLOR_DEFAULT  | 0xAFFFFFFF         | Default value of background color.        |
| S    | HEADER_CURSOR_DEFAULT   | &GUI_CursorHeaderM | Default cursor.                           |
| S    | HEADER_FONT_DEFAULT     | &GUI_Font13_1      | Default font.                             |
| N    | HEADER_BORDER_H_DEFAULT | 2                  | Horizontal space between text and border. |
| N    | HEADER_BORDER_V_DEFAULT | 0                  | Vertical space between text and border.   |

| Type | Macro                    | Default   | Description                      |
|------|--------------------------|-----------|----------------------------------|
| B    | HEADER_SUPPORT_DRAG      | 1         | Enable/disable dragging support. |
| N    | HEADER_TEXTCOLOR_DEFAULT | GUI_BLACK | Default value of text color.     |

### 6.2.12.2 Notification codes

The following events are sent from a HEADER widget to its parent window as part of a WM\_NOTIFY\_PARENT message:

| Message                   | Description   |
|---------------------------|---|
| WM_NOTIFICATION_CLICKED   | Widget has been clicked.  |
| WM_NOTIFICATION_RELEASED  | Widget has been released.   |
| WM_NOTIFICATION_MOVED_OUT | Widget has been clicked and pointer has been moved out of the widget without releasing. |

### 6.2.12.3 Keyboard reaction

The widget can not gain the input focus and does not react on keyboard input.

### 6.2.12.4 HEADER API

The table below lists the available emWin HEADER-related routines in alphabetical order. Detailed descriptions of the routines follow.

| Routine                                      | Description  |
|--|--|
| <a href="#">HEADER_AddItem()</a>             | Adds an item to an already existing HEADER widget.                               |
| <a href="#">HEADER_Create()</a>              | Creates a HEADER widget. (Obsolete)  |
| <a href="#">HEADER_CreateAttached()</a>      | Creates a HEADER widget attached to a window.                                    |
| <a href="#">HEADER_CreateEx()</a>            | Creates a HEADER widget.   |
| <a href="#">HEADER_CreateIndirect()</a>      | Creates a HEADER widget from a resource table entry.                             |
| <a href="#">HEADER_CreateUser()</a>          | Creates a HEADER widget using extra bytes as user data.                          |
| <a href="#">HEADER_DeleteItem()</a>          | Deletes an item from the HEADER widget.  |
| <a href="#">HEADER_GetBkColor()</a>          | Returns the background color of the given HEADER widget.                         |
| <a href="#">HEADER_GetBorderH()</a>          | Returns the horizontal border size of the HEADER.                                |
| <a href="#">HEADER_GetBorderV()</a>          | Returns the vertical border size of the HEADER.                                  |
| <a href="#">HEADER_GetColumnFromPos()</a>    | Returns the index of the column matching the given X-position.                   |
| <a href="#">HEADER_GetDefaultBkColor()</a>   | Returns the default background color used when creating a HEADER widget.         |
| <a href="#">HEADER_GetDefaultBorderH()</a>   | Returns the value used for the horizontal spacing when creating a HEADER widget. |
| <a href="#">HEADER_GetDefaultBorderV()</a>   | Returns the value used for the vertical spacing when creating a HEADER widget.   |
| <a href="#">HEADER_GetDefaultCursor()</a>    | Returns a pointer to the cursor displayed when dragging the width of an item.    |
| <a href="#">HEADER_GetDefaultFont()</a>      | Returns a pointer to the default font used when creating a HEADER widget.        |
| <a href="#">HEADER_GetDefaultTextColor()</a> | Returns the default text color used when creating a HEADER widget.               |

| Routine                                   | Description  |
|---|--|
| <code>HEADER_GetFont()</code>             | Returns the font of the given HEADER widget.                                       |
| <code>HEADER_GetHeight()</code>           | Returns the height of the given HEADER widget.                                     |
| <code>HEADER_GetItemText()</code>         | Returns the text for displaying an item with the given index.                      |
| <code>HEADER_GetItemWidth()</code>        | Returns the item width of the given HEADER widget.                                 |
| <code>HEADER_GetNumItems()</code>         | Returns the number of items of the given HEADER widget.                            |
| <code>HEADER_GetSel()</code>              | Returns the current selection of the HEADER widget.                                |
| <code>HEADER_GetTextColor()</code>        | Returns the text color of the given HEADER widget.                                 |
| <code>HEADER_GetUserData()</code>         | Retrieves the data set with <code>HEADER_SetUserData()</code> .                    |
| <code>HEADER_SetBitmap()</code>           | Sets the bitmap used when displaying the specified item.                           |
| <code>HEADER_SetBitmapEx()</code>         | Sets the bitmap used when displaying the specified item.                           |
| <code>HEADER_SetBkColor()</code>          | Sets the background color of the given HEADER widget.                              |
| <code>HEADER_SetBMP()</code>              | Sets the bitmap used when displaying the specified item.                           |
| <code>HEADER_SetBMPEX()</code>            | Sets the bitmap used when displaying the specified item.                           |
| <code>HEADER_SetDefaultBkColor()</code>   | Sets the default background color used when creating a HEADER widget.              |
| <code>HEADER_SetDefaultBorderH()</code>   | Sets the value used for the horizontal spacing when creating a HEADER widget.      |
| <code>HEADER_SetDefaultBorderV()</code>   | Sets the value used for the vertical spacing when creating a HEADER widget.        |
| <code>HEADER_SetDefaultCursor()</code>    | Sets the cursor which will be displayed when dragging the width of an HEADER item. |
| <code>HEADER_SetDefaultFont()</code>      | Sets the default font used when creating a HEADER widget.                          |
| <code>HEADER_SetDefaultTextColor()</code> | Returns the default text color used when creating a HEADER widget.                 |
| <code>HEADER_SetDragLimit()</code>        | Sets the limit for dragging the dividers on or off.                                |
| <code>HEADER_SetFixed()</code>            | Fixes the given number of columns at their horizontal positions.                   |
| <code>HEADER_SetFont()</code>             | Sets the font used when displaying the given HEADER widget.                        |
| <code>HEADER_SetHeight()</code>           | Sets the height of the given HEADER widget.  |
| <code>HEADER_SetItemText()</code>         | Sets the text used when displaying the specified item.                             |
| <code>HEADER_SetItemWidth()</code>        | Sets the width of the specified HEADER item.                                       |
| <code>HEADER_SetScrollPos()</code>        | Sets the horizontal scrolling position of the HEADER widget in pixels.             |
| <code>HEADER_SetStreamedBitmap()</code>   | Sets the bitmap used when displaying the specified item.                           |
| <code>HEADER_SetStreamedBitmapEx()</code> | Sets the bitmap used when displaying the specified item.                           |

| Routine                               | Description   |
|---------------------------------------|---|
| <a href="#">HEADER_SetTextAlign()</a> | Sets the text alignment of the specified HEADER item. |
| <a href="#">HEADER_SetTextColor()</a> | Sets the text color used when displaying the widget.  |
| <a href="#">HEADER_SetUserData()</a>  | Sets the extra data of a HEADER widget.               |

### 6.2.12.4.1 HEADER\_AddItem()

#### Description

Adds an item to an already existing HEADER widget.

#### Prototype

```
void HEADER_AddItem(    HEADER_Handle  hObj,
                      int             Width,
                      const char      * s,
                      int             Align);
```

#### Parameters

| Parameter             | Description   |
|-----------------------|---|
| <a href="#">hObj</a>  | Handle of HEADER widget.  |
| <a href="#">Width</a> | <a href="#">Width</a> of the new item.  |
| <a href="#">s</a>     | Text to be displayed.   |
| <a href="#">Align</a> | Text alignment mode to set. List of flags can be found under <i>Text alignment flags</i> on page 252. |

#### Additional information

The [width](#)-parameter can be 0. If [width](#) = 0 the width of the new item will be calculated by the given text and by the default value of the horizontal spacing.



### 6.2.12.4.2 HEADER\_Create()

#### Note

This function is **deprecated**, `HEADER_CreateEx()` should be used instead.

#### Description

Creates a HEADER widget of a specified size at a specified location.

#### Prototype

```
HEADER_Handle HEADER_Create(int    x0,
                             int    y0,
                             int    xSize,
                             int    ySize,
                             WM_HWIN hParent,
                             int    Id,
                             int    Flags,
                             int    ExFlags);
```

#### Parameters

| Parameter            | Description  |
|----------------------|--|
| <code>x0</code>      | Leftmost pixel of the HEADER widget (in parent coordinates).   |
| <code>y0</code>      | Topmost pixel of the HEADER widget (in parent coordinates).  |
| <code>xSize</code>   | Horizontal size of the HEADER widget (in pixels).  |
| <code>ySize</code>   | Vertical size of the HEADER widget (in pixels).  |
| <code>hParent</code> | Handle of the parent window  |
| <code>Id</code>      | <code>Id</code> of the new HEADER widget   |
| <code>Flags</code>   | Window create flags. Typically <code>WM_CF_SHOW</code> in order to make the widget visible immediately (refer to <i>Window create flags</i> on page 977 for a list of available parameter values). |
| <code>ExFlags</code> | (Reserved for later use)   |

#### Return value

Handle of the created HEADER widget; 0 if the function fails.

### 6.2.12.4.3 HEADER\_CreateAttached()

#### Description

Creates a HEADER widget which is attached to an existing window.

#### Prototype

```
HEADER_Handle HEADER_CreateAttached(WM_HWIN hParent,  
                                     int      Id,  
                                     int      SpecialFlags);
```

#### Parameters

| Parameter                    | Description                             |
|------------------------------|---|
| <a href="#">hObj</a>         | Handle HEADER of widget                 |
| <a href="#">Id</a>           | <a href="#">Id</a> of the HEADER widget |
| <a href="#">SpecialFlags</a> | (Not used, reserved for later use)      |

#### Return value

Handle of the created HEADER widget; 0 if the function fails.

#### Additional information

An attached HEADER widget is essentially a child window which will position itself on the parent window and operate accordingly.

### 6.2.12.4.4 HEADER\_CreateEx()

#### Description

Creates a HEADER widget of a specified size at a specified location.

#### Prototype

```
HEADER_Handle HEADER_CreateEx(int    x0,
                              int    y0,
                              int    xSize,
                              int    ySize,
                              WM_HWIN hParent,
                              int    WinFlags,
                              int    ExFlags,
                              int    Id);
```

#### Parameters

| Parameter             | Description  |
|-----------------------|--|
| <code>x0</code>       | Leftmost pixel of the widget (in parent coordinates).  |
| <code>y0</code>       | Topmost pixel of the widget (in parent coordinates).   |
| <code>xSize</code>    | Horizontal size of the widget (in pixels).   |
| <code>ySize</code>    | Vertical size of the widget (in pixels).   |
| <code>hParent</code>  | Handle of parent window. If 0, the new HEADER widget will be a child of the desktop (top-level window).  |
| <code>WinFlags</code> | Window create flags. Typically <code>WM_CF_SHOW</code> in order to make the widget visible immediately (refer to <i>Window create flags</i> on page 977 for a list of available parameter values). |
| <code>ExFlags</code>  | Not used, reserved for future use.   |
| <code>Id</code>       | Window ID of the widget.   |

#### Return value

Handle of the created HEADER widget; 0 if the function fails.

#### 6.2.12.4.5 HEADER\_CreateIndirect()

##### Description

The prototype of this function is explained at the beginning of this chapter. For details the function `<WIDGET>_CreateIndirect()` on page 992 should be referred to. The element `Flags` is used according to the parameter `WinFlags` of the function `HEADER_CreateEx()`. The element `Para` is not used.

#### 6.2.12.4.6 HEADER\_CreateUser()

##### Description

Prototype explained at the beginning of the chapter as `<WIDGET>_CreateUser()` on page 993. For a detailed description of the parameters the function `HEADER_CreateEx()` can be referred to.

### 6.2.12.4.7 HEADER\_DeleteItem()

#### Description

Deletes an item from the HEADER widget.

#### Prototype

```
void HEADER_DeleteItem(HEADER_Handle hObj,  
                       unsigned      Index);
```

#### Parameters

| Parameter             | Description                           |
|-----------------------|---------------------------------------|
| <a href="#">hObj</a>  | Handle of HEADER widget.              |
| <a href="#">Index</a> | <a href="#">Index</a> of HEADER item. |

#### 6.2.12.4.8 HEADER\_GetBkColor()

##### Description

Returns the background color of the given HEADER widget.

##### Prototype

```
GUI_COLOR HEADER_GetBkColor(HEADER_Handle hObj);
```

##### Parameters

| Parameter            | Description              |
|----------------------|--------------------------|
| <a href="#">hObj</a> | Handle of HEADER widget. |

##### Return value

The background color of the given HEADER widget.

#### 6.2.12.4.9 HEADER\_GetBorderH()

##### Description

Returns the horizontal border size of the HEADER.

##### Prototype

```
U8 HEADER_GetBorderH(HEADER_Handle hObj);
```

##### Parameters

| Parameter            | Description              |
|----------------------|--------------------------|
| <a href="#">hObj</a> | Handle of HEADER widget. |

##### Return value

Horizontal border size of the HEADER.



#### 6.2.12.4.10 HEADER\_GetBorderV()

##### Description

Returns the vertical border size of the HEADER.

##### Prototype

```
U8 HEADER_GetBorderV(HEADER_Handle hObj);
```

##### Parameters

| Parameter            | Description              |
|----------------------|--------------------------|
| <a href="#">hObj</a> | Handle of HEADER widget. |

##### Return value

Vertical border size of the HEADER.

### 6.2.12.4.11 HEADER\_GetColumnFromPos()

#### Description

Returns the index of the column matching the given X-position.

#### Prototype

```
int HEADER_GetColumnFromPos(HEADER_Handle hObj,  
                             int          x);
```

#### Parameters

| Parameter         | Description              |
|-------------------|--------------------------|
| <code>hObj</code> | Handle of HEADER widget. |
| <code>x</code>    | X-position of the item.  |

#### Return value

- = -1     Error.
- ≠ -1    Zero-based index of the item matching the X-position.

#### 6.2.12.4.12 HEADER\_GetDefaultBkColor()

##### Description

Returns the default background color used when creating a HEADER widget.

##### Prototype

```
GUI_COLOR HEADER_GetDefaultBkColor(void);
```

##### Return value

Default background color used when creating a HEADER widget.

### 6.2.12.4.13 HEADER\_GetDefaultBorderH()

#### Description

Returns the value used for the horizontal spacing when creating a HEADER widget.

#### Prototype

```
int HEADER_GetDefaultBorderH(void);
```

#### Return value

Value used for the horizontal spacing when creating a HEADER widget.

#### Additional information

Horizontal spacing means the horizontal distance in pixel between text and the horizontal border of the item. Horizontal spacing takes effect only if the given width of a new item is 0.

#### 6.2.12.4.14 HEADER\_GetDefaultBorderV()

##### Description

Returns the value used for the vertical spacing when creating a HEADER widget.

##### Prototype

```
int HEADER_GetDefaultBorderV(void);
```

##### Return value

Value used for the vertical spacing when creating a HEADER widget.

##### Additional information

Vertical spacing means the vertical distance in pixel between text and the vertical border of the HEADER widget.

#### 6.2.12.4.15 HEADER\_GetDefaultCursor()

##### Description

Returns a pointer to the cursor displayed when dragging the width of an item.

##### Prototype

```
GUI_CURSOR *HEADER_GetDefaultCursor(void);
```

##### Return value

Pointer to the cursor displayed when dragging the width of an item.

#### 6.2.12.4.16 HEADER\_GetDefaultFont()

##### Description

Returns a pointer to the default font used when creating a HEADER widget.

##### Prototype

```
GUI_FONT *HEADER_GetDefaultFont(void);
```

##### Return value

Pointer to the default font used when creating a HEADER widget.

#### 6.2.12.4.17 HEADER\_GetDefaultTextColor()

##### Description

Returns the default text color used when creating a HEADER widget.

##### Prototype

```
GUI_COLOR HEADER_GetDefaultTextColor(void);
```

##### Return value

Default text color used when creating a HEADER widget.



#### 6.2.12.4.18 HEADER\_GetFont()

##### Description

Returns the font of the given HEADER widget.

##### Prototype

```
GUI_FONT *HEADER_GetFont(HEADER_Handle hObj);
```

##### Parameters

| Parameter            | Description              |
|----------------------|--------------------------|
| <a href="#">hObj</a> | Handle of HEADER widget. |

##### Return value

The currently set font of the given HEADER widget.

#### 6.2.12.4.19 HEADER\_GetHeight()

##### Description

Returns the height of the given HEADER widget.

##### Prototype

```
int HEADER_GetHeight(HEADER_Handle hObj);
```

##### Parameters

| Parameter            | Description              |
|----------------------|--------------------------|
| <a href="#">hObj</a> | Handle of HEADER widget. |

##### Return value

Height of the given HEADER widget.

#### 6.2.12.4.20 HEADER\_GetItemText()

##### Description

Returns the text for displaying an item with the given index.

##### Prototype

```
int HEADER_GetItemText(HEADER_Handle hObj,  
                      unsigned Index,  
                      char * pBuffer,  
                      int MaxSize);
```

##### Parameters

| Parameter               | Description                                     |
|-------------------------|---|
| <a href="#">hObj</a>    | Handle of HEADER widget.                        |
| <a href="#">Index</a>   | <a href="#">Index</a> of HEADER item.           |
| <a href="#">pBuffer</a> | Pointer to a buffer to hold the retrieved text. |
| <a href="#">MaxSize</a> | The size of <a href="#">pBuffer</a> .           |

#### 6.2.12.4.21 HEADER\_GetItemWidth()

##### Description

Returns the item width of the given HEADER widget.

##### Prototype

```
int HEADER_GetItemWidth(HEADER_Handle hObj,  
                        unsigned int Index);
```

##### Parameters

| Parameter             | Description                        |
|-----------------------|------------------------------------|
| <a href="#">hObj</a>  | Handle of HEADER widget.           |
| <a href="#">Index</a> | <a href="#">Index</a> of the item. |

##### Return value

Width of the item.

#### 6.2.12.4.22 HEADER\_GetNumItems()

##### Description

Returns the number of items of the given HEADER widget.

##### Prototype

```
int HEADER_GetNumItems(HEADER_Handle hObj);
```

##### Parameters

| Parameter            | Description              |
|----------------------|--------------------------|
| <a href="#">hObj</a> | Handle of HEADER widget. |

##### Return value

Number of items of the given HEADER widget.

### 6.2.12.4.23 HEADER\_GetSel()

#### Description

Returns the current selection of the HEADER widget.

#### Prototype

```
int HEADER_GetSel(HEADER_Handle hObj);
```

#### Parameters

| Parameter            | Description              |
|----------------------|--------------------------|
| <a href="#">hObj</a> | Handle of HEADER widget. |

#### Return value

Current selection.

#### 6.2.12.4.24 HEADER\_GetTextColor()

##### Description

Returns the text color of the given HEADER widget.

##### Prototype

```
GUI_COLOR HEADER_GetTextColor(HEADER_Handle hObj);
```

##### Parameters

| Parameter            | Description              |
|----------------------|--------------------------|
| <a href="#">hObj</a> | Handle of HEADER widget. |

##### Return value

The text color of the given HEADER widget.

#### 6.2.12.4.25 HEADER\_GetUserData()

##### Description

Prototype explained at the beginning of the chapter as `<WIDGET>_GetUserData()` on page 994.



### 6.2.12.4.26 HEADER\_SetBitmap()

#### Description

Sets the bitmap used when displaying the specified item.

#### Prototype

```
void HEADER_SetBitmap(    HEADER_Handle  hObj,  
                        unsigned      Index,  
                        const GUI_BITMAP * pBitmap);
```

#### Parameters

| Parameter               | Description                                   |
|-------------------------|---|
| <a href="#">hObj</a>    | Handle of HEADER widget                       |
| <a href="#">Index</a>   | <a href="#">Index</a> of the item             |
| <a href="#">pBitmap</a> | Pointer to a bitmap structure to be displayed |

#### Additional information

One item of a HEADER widget can contain text and a bitmap. Have a look at the example at [HEADER\\_SetBitmapEx\(\)](#).

### 6.2.12.4.27 HEADER\_SetBitmapEx()

#### Description

Sets the bitmap used when displaying the specified item.

#### Prototype

```
void HEADER_SetBitmapEx(    HEADER_Handle  hObj,
                           unsigned      Index,
                           const GUI_BITMAP * pBitmap,
                           int           x,
                           int           y);
```

#### Parameters

| Parameter            | Description                                   |
|----------------------|---|
| <code>hObj</code>    | Handle of HEADER widget                       |
| <code>Index</code>   | <code>Index</code> of the item                |
| <code>pBitmap</code> | Pointer to a bitmap structure to be displayed |
| <code>x</code>       | Additional offset in <code>x</code>           |
| <code>y</code>       | Additional offset in <code>y</code>           |

#### Additional information

One item of a HEADER widget can contain text and a bitmap.

#### Example

```
...
HEADER_Handle hHeader;
GUI_Init();
HEADER_SetDefaultTextColor(GUI_YELLOW);
HEADER_SetDefaultFont(&GUI_Font8x8);
hHeader = HEADER_Create(10, 10, 100, 40, WM_HBKWIN, 1234, WM_CF_SHOW, 0);
HEADER_AddItem(hHeader, 50, "Phone", GUI_TA_BOTTOM | GUI_TA_HCENTER);
HEADER_AddItem(hHeader, 50, "Code", GUI_TA_BOTTOM | GUI_TA_HCENTER);
HEADER_SetBitmapEx(hHeader, 0, &bmPhone, 0, -15);
HEADER_SetBitmapEx(hHeader, 1, &bmCode, 0, -15);
...
```

#### Screenshot of above example



#### 6.2.12.4.28 HEADER\_SetBkColor()

##### Description

Sets the background color of the given HEADER widget.

##### Prototype

```
void HEADER_SetBkColor(HEADER_Handle hObj,  
                       GUI_COLOR     Color);
```

##### Parameters

| Parameter          | Description                 |
|--------------------|-----------------------------|
| <code>hObj</code>  | Handle of HEADER widget.    |
| <code>Color</code> | Background color to be set. |

### 6.2.12.4.29 HEADER\_SetBMP()

#### Description

Sets the bitmap used when displaying the specified item.

#### Prototype

```
void HEADER_SetBMP(      HEADER_Handle  hObj,  
                        unsigned int   Index,  
                        const void     * pBitmap);
```

#### Parameters

| Parameter               | Description                          |
|-------------------------|--------------------------------------|
| <a href="#">hObj</a>    | Handle of HEADER widget              |
| <a href="#">Index</a>   | <a href="#">Index</a> of HEADER item |
| <a href="#">pBitmap</a> | Pointer to bitmap file data          |

#### Additional information

For additional information regarding bitmap files, refer to the chapter *Displaying bitmap files* on page 425.

### 6.2.12.4.30 HEADER\_SetBMPEx()

#### Description

Sets the bitmap used when displaying the specified item.

#### Prototype

```
void HEADER_SetBMPEx(    HEADER_Handle  hObj,
                        unsigned int   Index,
                        const void      * pBitmap,
                        int              x,
                        int              y);
```

#### Parameters

| Parameter               | Description                            |
|-------------------------|--|
| <a href="#">hObj</a>    | Handle of HEADER widget                |
| <a href="#">Index</a>   | <a href="#">Index</a> of HEADER item   |
| <a href="#">pBitmap</a> | Pointer to bitmap file data            |
| <a href="#">x</a>       | Additional offset in <a href="#">x</a> |
| <a href="#">y</a>       | Additional offset in <a href="#">y</a> |

#### Additional information

For additional information regarding bitmap files, refer to the chapter *Displaying bitmap files* on page 425.

### 6.2.12.4.31 HEADER\_SetBorderH()

#### Description

Sets the horizontal border size of the HEADER.

#### Prototype

```
void HEADER_SetBorderH(HEADER_Handle hObj,  
                       U8             Border);
```

#### Parameters

| Parameter           | Description                 |
|---------------------|-----------------------------|
| <code>hObj</code>   | Handle of HEADER widget.    |
| <code>Border</code> | New horizontal border size. |

### 6.2.12.4.32 HEADER\_SetBorderV()

#### Description

Sets the vertical border size of the HEADER.

#### Prototype

```
void HEADER_SetBorderV(HEADER_Handle hObj,  
                       U8            Border);
```

#### Parameters

| Parameter              | Description               |
|------------------------|---------------------------|
| <a href="#">hObj</a>   | Handle of HEADER widget.  |
| <a href="#">Border</a> | New vertical border size. |

### 6.2.12.4.33 HEADER\_SetDefaultBkColor()

#### Description

Sets the default background color used when creating a HEADER widget.

#### Prototype

```
GUI_COLOR HEADER_SetDefaultBkColor(GUI_COLOR Color);
```

#### Parameters

| Parameter | Description                 |
|-----------|-----------------------------|
| Color     | Background color to be used |

#### Return value

Previous default background color.



#### 6.2.12.4.34 HEADER\_SetDefaultBorderH()

##### Description

Sets the value used for the horizontal spacing when creating a HEADER widget.

##### Prototype

```
int HEADER_SetDefaultBorderH(int Spacing);
```

##### Parameters

| Parameter | Description      |
|-----------|------------------|
| Spacing   | Value to be used |

##### Return value

Previous default value.

##### Additional information

Horizontal spacing means the horizontal distance in pixel between text and the horizontal border of the item. Horizontal spacing takes effect only if the given width of a new item is 0.

### 6.2.12.4.35 HEADER\_SetDefaultBorderV()

#### Description

Sets the value used for the vertical spacing when creating a HEADER widget.

#### Prototype

```
int HEADER_SetDefaultBorderV(int Spacing);
```

#### Parameters

| Parameter | Description      |
|-----------|------------------|
| Spacing   | Value to be used |

#### Return value

Previous default value.

#### Additional information

Vertical spacing means the vertical distance in pixel between text and the vertical border of the HEADER widget.

### 6.2.12.4.36 HEADER\_SetDefaultCursor()

#### Description

Sets the cursor which will be displayed when dragging the width of an HEADER item.

#### Prototype

```
GUI_CURSOR *HEADER_SetDefaultCursor(const GUI_CURSOR * pCursor);
```

#### Parameters

| Parameter            | Description   |
|----------------------|---|
| <code>pCursor</code> | Pointer to the cursor to be shown when dragging the width of an HEADER item |

#### Return value

Pointer to the previous default cursor.

#### Additional information

There are 2 predefined cursors shown at the beginning of this chapter.

### 6.2.12.4.37 HEADER\_SetDefaultFont()

#### Description

Sets the default font used when creating a HEADER widget.

#### Prototype

```
GUI_FONT *HEADER_SetDefaultFont(const GUI_FONT * pFont);
```

#### Parameters

| Parameter          | Description                |
|--------------------|----------------------------|
| <code>pFont</code> | Pointer to font to be used |

#### Return value

Pointer to previous default font.

#### 6.2.12.4.38 HEADER\_SetDefaultTextColor()

##### Description

Returns the default text color used when creating a HEADER widget.

##### Prototype

```
GUI_COLOR HEADER_SetDefaultTextColor(GUI_COLOR Color);
```

##### Parameters

| Parameter | Description      |
|-----------|------------------|
| Color     | Color to be used |

##### Return value

Previous default value.

### 6.2.12.4.39 HEADER\_SetDragLimit()

#### Description

Sets the limit for dragging the dividers on or off. If the limit is on, a divider can only be dragged within the widget area. If the limit is off, it can be dragged outside the widget.

#### Prototype

```
void HEADER_SetDragLimit(HEADER_Handle hObj,  
                        unsigned      OnOff);
```

#### Parameters

| Parameter          | Description                                 |
|--------------------|---|
| <code>hObj</code>  | Handle of HEADER widget.                    |
| <code>OnOff</code> | 1 for setting the drag limit on, 0 for off. |

#### 6.2.12.4.40 HEADER\_SetFixed()

##### Description

Fixes the given number of columns at their horizontal positions.

##### Prototype

```
unsigned HEADER_SetFixed(HEADER_Handle hObj,  
                        unsigned Fixed);
```

##### Parameters

| Parameter          | Description  |
|--------------------|--|
| <code>hObj</code>  | Handle of HEADER widget.                                     |
| <code>Fixed</code> | Number of columns to be fixed at their horizontal positions. |

##### Return value

Old value of fixed columns.

##### Additional information

Using this function makes sense if one or more columns should remain at their horizontal positions during scrolling operations.

#### 6.2.12.4.41 HEADER\_SetFont()

##### Description

Sets the font used when displaying the given HEADER widget.

##### Prototype

```
void HEADER_SetFont(      HEADER_Handle  hObj,  
                      const GUI_FONT   * pFont);
```

##### Parameters

| Parameter          | Description                 |
|--------------------|-----------------------------|
| <code>hObj</code>  | Handle of HEADER widget.    |
| <code>pFont</code> | Pointer to font to be used. |



#### 6.2.12.4.42 HEADER\_SetHeight()

##### Description

Sets the height of the given HEADER widget.

##### Prototype

```
void HEADER_SetHeight(HEADER_Handle hObj,  
                      int           Height);
```

##### Parameters

| Parameter           | Description              |
|---------------------|--------------------------|
| <code>hObj</code>   | Handle of HEADER widget. |
| <code>Height</code> | New height.              |

#### 6.2.12.4.43 HEADER\_SetItemText()

##### Description

Sets the text used when displaying the specified item.

##### Prototype

```
void HEADER_SetItemText(    HEADER_Handle  hObj,  
                           unsigned int   Index,  
                           const char     * s);
```

##### Parameters

| Parameter             | Description                           |
|-----------------------|---------------------------------------|
| <a href="#">hObj</a>  | Handle of HEADER widget.              |
| <a href="#">Index</a> | <a href="#">Index</a> of HEADER item. |
| <a href="#">s</a>     | Pointer to string to be displayed.    |

##### Additional information

One HEADER item can contain a string and a bitmap.

#### 6.2.12.4.44 HEADER\_SetItemWidth()

##### Description

Sets the width of the specified HEADER item.

##### Prototype

```
void HEADER_SetItemWidth(HEADER_Handle hObj,  
                          unsigned int  Index,  
                          int           Width);
```

##### Parameters

| Parameter             | Description                           |
|-----------------------|---------------------------------------|
| <a href="#">hObj</a>  | Handle of HEADER widget.              |
| <a href="#">Index</a> | <a href="#">Index</a> of HEADER item. |
| <a href="#">Width</a> | New width.                            |

#### 6.2.12.4.45 HEADER\_SetScrollPos()

##### Description

Sets the horizontal scrolling position of the HEADER widget in pixels.

##### Prototype

```
void HEADER_SetScrollPos(HEADER_Handle hObj,  
                        int ScrollPos);
```

##### Parameters

| Parameter              | Description                    |
|------------------------|--------------------------------|
| <code>hObj</code>      | Handle of HEADER widget.       |
| <code>ScrollPos</code> | New scroll position in pixels. |

### 6.2.12.4.46 HEADER\_SetStreamedBitmap()

#### Description

Sets the bitmap used when displaying the specified item.

#### Prototype

```
void HEADER_SetStreamedBitmap(    HEADER_Handle    hObj,
                                unsigned int      Index,
                                const GUI_BITMAP_STREAM * pBitmap);
```

#### Parameters

| Parameter            | Description                                     |
|----------------------|---|
| <code>hObj</code>    | Handle of HEADER widget                         |
| <code>Index</code>   | <code>Index</code> of the item                  |
| <code>pBitmap</code> | Pointer to streamed bitmap data to be displayed |

#### Additional information

For additional information regarding streamed bitmap files, refer to the chapter *2-D Graphic Library* on page 277.

#### 6.2.12.4.47 HEADER\_SetStreamedBitmapEx()

##### Description

Sets the bitmap used when displaying the specified item.

##### Prototype

```
void HEADER_SetStreamedBitmapEx(    HEADER_Handle    hObj,
                                   unsigned int        Index,
                                   const GUI_BITMAP_STREAM * pBitmap,
                                   int                    x,
                                   int                    y);
```

##### Parameters

| Parameter               | Description                                     |
|-------------------------|---|
| <a href="#">hObj</a>    | Handle of HEADER widget                         |
| <a href="#">Index</a>   | <a href="#">Index</a> of the item               |
| <a href="#">pBitmap</a> | Pointer to streamed bitmap data to be displayed |
| <a href="#">x</a>       | Additional offset in <a href="#">x</a>          |
| <a href="#">y</a>       | Additional offset in <a href="#">y</a>          |

##### Additional information

For additional information regarding streamed bitmap files, refer to the chapter *2-D Graphic Library* on page 277.

#### 6.2.12.4.48 HEADER\_SetTextAlign()

##### Description

Sets the text alignment of the specified HEADER item.

##### Prototype

```
void HEADER_SetTextAlign(HEADER_Handle hObj,  
                        unsigned int  Index,  
                        int           Align);
```

##### Parameters

| Parameter          | Description   |
|--------------------|---|
| <code>hObj</code>  | Handle of HEADER widget.  |
| <code>Index</code> | <code>Index</code> of HEADER item.  |
| <code>Align</code> | Text alignment mode to set. List of flags can be found under <i>Text alignment flags</i> on page 252. |

#### 6.2.12.4.49 HEADER\_SetTextColor()

##### Description

Sets the text color used when displaying the widget.

##### Prototype

```
void HEADER_SetTextColor(HEADER_Handle hObj,  
                        GUI_COLOR      Color);
```

##### Parameters

| Parameter          | Description                    |
|--------------------|--------------------------------|
| <code>hObj</code>  | Handle of HEADER widget.       |
| <code>Color</code> | <code>Color</code> to be used. |



#### 6.2.12.4.50 HEADER\_SetUserData()

##### Description

Prototype explained at the beginning of the chapter as `<WIDGET>_SetUserData()` on page 995.

### 6.2.12.5 Example

The `Sample` folder contains the following example which shows how the widget can be used:

- `WIDGET_Header.c`

Note that several other examples also make use of this widget and may also be helpful to get familiar with the widget.

#### Screenshot of `WIDGET_Header.c`:

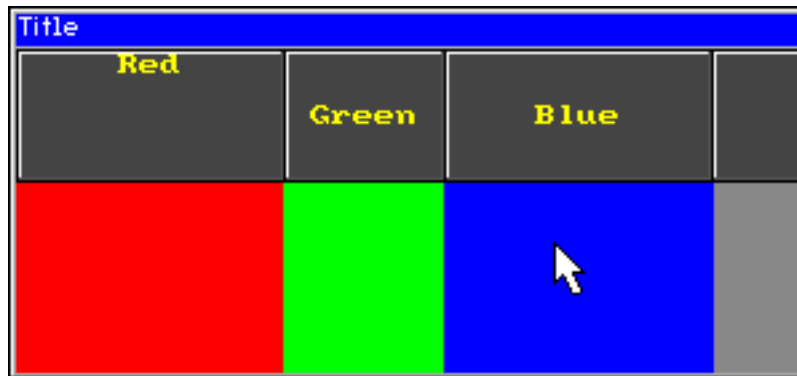

## 6.2.13 ICONVIEW: Icon view widget

The ICONVIEW widget can be used for icon based menus often required in hand held devices like mobile telephones or pocket organizers. It shows a list of icons where each icon can be labeled with optional text. Icon view widgets support transparency and alpha blending. So any content can be shown in the background. The currently selected icon can be highlighted by a solid color or with an alpha blending effect, which lets the background shine through. If required a scroll bar can be shown.

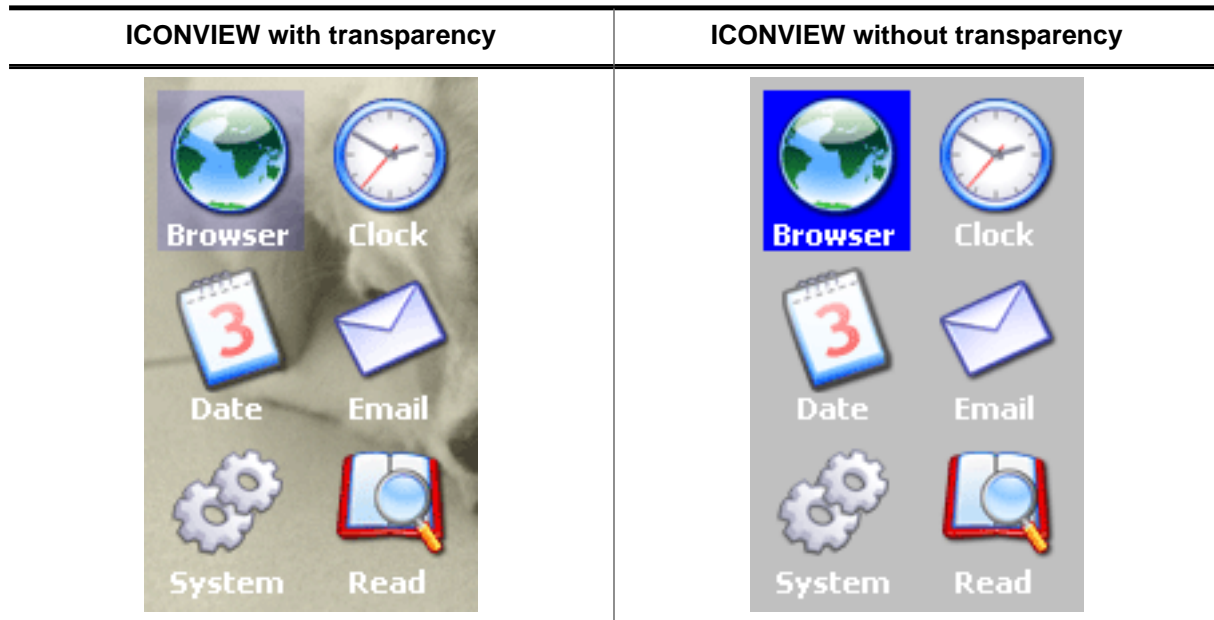

### Note

All ICONVIEW-related routines are located in the file(s) ICONVIEW\*.c, ICONVIEW\*.h. All identifiers are prefixed ICONVIEW.

### 6.2.13.1 Configuration options

| Type | Macro                       | Default      | Description   |
|------|-----------------------------|--------------|---|
| N    | ICONVIEW_BKCOLOR0_DEFAULT   | GUI_WHITE    | Background color, unselected state.                                       |
| N    | ICONVIEW_BKCOLOR1_DEFAULT   | GUI_BLUE     | Background color, selected state.   |
| N    | ICONVIEW_TEXTCOLOR0_DEFAULT | GUI_WHITE    | Text color, unselected state.   |
| N    | ICONVIEW_TEXTCOLOR1_DEFAULT | GUI_WHITE    | Text color, selected state.   |
| S    | ICONVIEW_FONT_DEFAULT       | GUI_Font13_1 | Font to be used for drawing the labels.                                   |
| N    | ICONVIEW_FRAMEX_DEFAULT     | 5            | Free space between the icons and the left and right border of the widget. |
| N    | ICONVIEW_FRAMEY_DEFAULT     | 5            | Free space between the icons and the top and bottom border of the widget. |
| N    | ICONVIEW_SPACEX_DEFAULT     | 5            | Free horizontal space between the icons.                                  |
| N    | ICONVIEW_SPACEY_DEFAULT     | 5            | Free vertical space between the icons.                                    |

| Type | Macro                  | Default                           | Description  |
|------|------------------------|-----------------------------------|--|
| N    | ICONVIEW_ALIGN_DEFAULT | GUI_TA_HCENTER  <br>GUI_TA_BOTTOM | Default alignment to be used for drawing the labels. |

### 6.2.13.2 Predefined IDs

The following symbols define IDs which may be used to make ICONVIEW widgets distinguishable from creation.

```
#define GUI_ID_ICONVIEW0    0x250
#define GUI_ID_ICONVIEW1    0x251
#define GUI_ID_ICONVIEW2    0x252
#define GUI_ID_ICONVIEW3    0x253
#define GUI_ID_ICONVIEW4    0x254
#define GUI_ID_ICONVIEW5    0x255
#define GUI_ID_ICONVIEW6    0x256
#define GUI_ID_ICONVIEW7    0x257
#define GUI_ID_ICONVIEW8    0x258
#define GUI_ID_ICONVIEW9    0x259
```

### 6.2.13.3 Notification codes

The following events are sent from an ICONVIEW widget to its parent window as part of a WM\_NOTIFY\_PARENT message:

| Message                        | Description  |
|--------------------------------|--|
| WM_NOTIFICATION_CLICKED        | Widget has been clicked.   |
| WM_NOTIFICATION_RELEASED       | Widget has been released.  |
| WM_NOTIFICATION_MOVED_OUT      | Widget has been clicked and pointer has been moved out of the widget area without releasing. |
| WM_NOTIFICATION_SCROLL_CHANGED | The scroll position of the optional scroll bar has been changed.                             |
| WM_NOTIFICATION_SEL_CHANGED    | The selection of the widget has been changed.  |

### 6.2.13.4 Keyboard reaction

The widget reacts to the following keys if it has the input focus:

| Key           | Reaction                                  |
|---------------|---|
| GUI_KEY_RIGHT | Moves the selection to the next icon.     |
| GUI_KEY_LEFT  | Moves the selection to the previous icon. |
| GUI_KEY_DOWN  | Moves the selection down.                 |
| GUI_KEY_UP    | Moves the selection up.                   |
| GUI_KEY_HOME  | Moves the selection to the first icon.    |
| GUI_KEY_END   | Moves the selection to the last icon.     |

## 6.2.13.5 ICONVIEW API

The table below lists the available emWin ICONVIEW-related routines in alphabetical order. Detailed descriptions of the routines follow.

### Functions

| Routine  | Description  |
|--|--|
| <code>ICONVIEW_AddBitmapItem()</code>            | Adds a new bitmap icon to the widget.                                      |
| <code>ICONVIEW_AddStreamedBitmapItem()</code>    | Adds a new streamed bitmap icon to the widget.                             |
| <code>ICONVIEW_CreateEx()</code>                 | Creates an ICONVIEW widget.  |
| <code>ICONVIEW_CreateIndirect()</code>           | Creates an ICONVIEW widget from a resource table entry.                    |
| <code>ICONVIEW_CreateUser()</code>               | Creates an ICONVIEW widget using extra bytes as user data.                 |
| <code>ICONVIEW_DeleteItem()</code>               | Deletes an existing item.  |
| <code>ICONVIEW_EnableStreamAuto()</code>         | Enables full support for streamed bitmaps.                                 |
| <code>ICONVIEW_GetBkColor()</code>               | Returns the background color of the widget.                                |
| <code>ICONVIEW_GetFont()</code>                  | Returns the font of the widget.  |
| <code>ICONVIEW_GetItemBitmap()</code>            | Retrieves the bitmap of a specified ICONVIEW item.                         |
| <code>ICONVIEW_GetItemText()</code>              | Retrieves the text of a specified ICONVIEW item.                           |
| <code>ICONVIEW_GetItemUserData()</code>          | Retrieves the previously stored user data from a specific item.            |
| <code>ICONVIEW_GetNumItems()</code>              | Returns the number of items in the given ICONVIEW widget.                  |
| <code>ICONVIEW_GetReleasedItem()</code>          | This function returns the index of the released ICONVIEW item.             |
| <code>ICONVIEW_GetSel()</code>                   | Returns the zero based index of the currently selected icon.               |
| <code>ICONVIEW_GetTextColor()</code>             | Returns the text color of the widget.                                      |
| <code>ICONVIEW_GetUserData()</code>              | Retrieves the data set with <code>ICONVIEW_SetUserData()</code> .          |
| <code>ICONVIEW_InsertBitmapItem()</code>         | Inserts a new bitmap icon to the widget.                                   |
| <code>ICONVIEW_InsertStreamedBitmapItem()</code> | Inserts a new streamed bitmap icon to the widget.                          |
| <code>ICONVIEW_OwnerDraw()</code>                | Default function for drawing a ICONVIEW widget.                            |
| <code>ICONVIEW_SetBitmapItem()</code>            | Sets a bitmap to be used by a specific item.                               |
| <code>ICONVIEW_SetBkColor()</code>               | Sets the background color of the widget.                                   |
| <code>ICONVIEW_SetFont()</code>                  | Sets the font to be used for drawing the icon labels.                      |
| <code>ICONVIEW_SetFrame()</code>                 | Sets the size of the frame between the border of the widget and the icons. |
| <code>ICONVIEW_SetIconAlign()</code>             | Sets the icon alignment.   |
| <code>ICONVIEW_SetItemText()</code>              | Sets the text of a specific item.  |
| <code>ICONVIEW_SetItemUserData()</code>          | Stores user data in a specific item.                                       |

| Routine                                       | Description  |
|---|--|
| <code>ICONVIEW_SetOwnerDraw()</code>          | Sets a custom defined drawing function.                          |
| <code>ICONVIEW_SetSel()</code>                | Sets the current selection.                                      |
| <code>ICONVIEW_SetSpace()</code>              | Sets the space between icons in x- or y-direction.               |
| <code>ICONVIEW_SetStreamedBitmapItem()</code> | Sets a streamed bitmap to be used by a specific item.            |
| <code>ICONVIEW_SetTextAlign()</code>          | Sets the text align of the item texts.                           |
| <code>ICONVIEW_SetTextColor()</code>          | Sets the color to be used to draw the labels.                    |
| <code>ICONVIEW_SetUserData()</code>           | Sets the extra data of an ICONVIEW widget.                       |
| <code>ICONVIEW_SetWrapMode()</code>           | Sets the wrapping mode to be used for the given ICONVIEW widget. |

## Defines

| Group of defines                      | Description   |
|---------------------------------------|---|
| <code>ICONVIEW alignment flags</code> | Alignment flags used for <code>ICONVIEW_SetIconAlign()</code> . |
| <code>ICONVIEW color indexes</code>   | Color indexes used by the ICONVIEW widget.                      |
| <code>ICONVIEW create flags</code>    | Create flags used for ICONVIEW widgets.                         |

## 6.2.13.5.1 Functions

### 6.2.13.5.1.1 ICONVIEW\_AddBitmapItem()

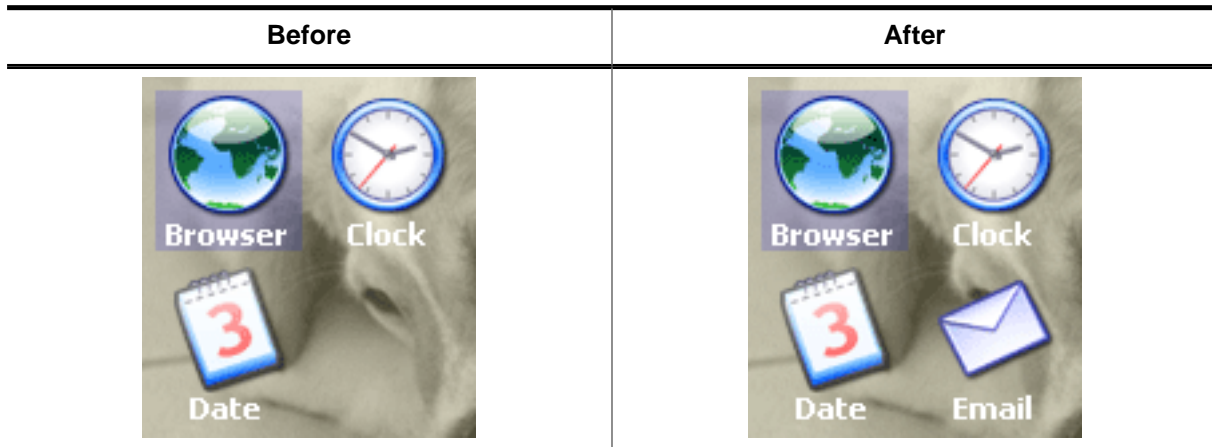

#### Description

Adds a new bitmap icon to the widget.

#### Prototype

```
int ICONVIEW_AddBitmapItem(    ICONVIEW_Handle  hObj,
                             const GUI_BITMAP  * pBitmap,
                             const char       * pText);
```

#### Parameters

| Parameter            | Description  |
|----------------------|--|
| <code>hObj</code>    | Handle of ICONVIEW widget.                           |
| <code>pBitmap</code> | Pointer to a bitmap structure used to draw the icon. |
| <code>pText</code>   | Text to be used to label the icon.                   |

#### Return value

= 0      on success  
 ≠ 0      on error.

#### Additional information

Note that the bitmap pointer needs to remain valid.

### 6.2.13.5.1.2 ICONVIEW\_AddStreamedBitmapItem()

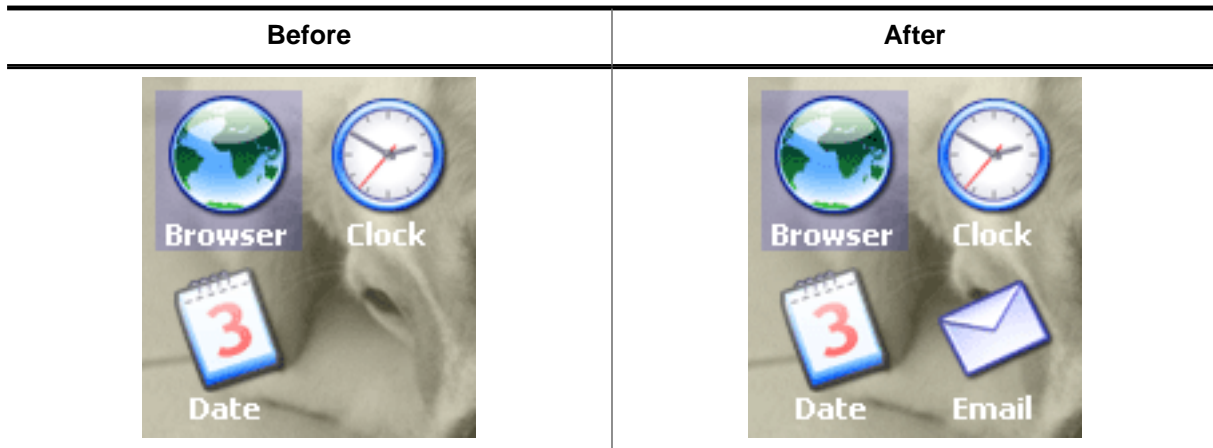

#### Description

Adds a new streamed bitmap icon to the widget.

#### Prototype

```
int ICONVIEW_AddStreamedBitmapItem(    ICONVIEW_Handle  hObj,
                                       const void         * pStreamedBitmap,
                                       const char          * pText);
```

#### Parameters

| Parameter                    | Description                                       |
|------------------------------|---|
| <code>hObj</code>            | Handle of ICONVIEW widget.                        |
| <code>pStreamedBitmap</code> | Pointer to a bitmap stream used to draw the icon. |
| <code>pText</code>           | Text to be used to label the icon.                |

#### Return value

= 0      on success  
 ≠ 0      on error.

#### Additional information

The pointer to the bitmap stream needs to remain valid.



### 6.2.13.5.1.3 ICONVIEW\_CreateEx()

#### Description

Creates an ICONVIEW widget of a specified size at a specified location.

#### Prototype

```
ICONVIEW_Handle ICONVIEW_CreateEx(int    x0,
                                   int    y0,
                                   int    xSize,
                                   int    ySize,
                                   WM_HWIN hParent,
                                   int    WinFlags,
                                   int    ExFlags,
                                   int    Id,
                                   int    xSizeItems,
                                   int    ySizeItems);
```

#### Parameters

| Parameter              | Description  |
|------------------------|--|
| <code>x0</code>        | Leftmost pixel of the widget in parent coordinates.  |
| <code>y0</code>        | Topmost pixel of the widget in parent coordinates.   |
| <code>xSize</code>     | Horizontal size of the widget in pixels.   |
| <code>ySize</code>     | Vertical size of the widget in pixels.   |
| <code>hParent</code>   | Handle of parent window. If 0, the new widget will be a child window of the desktop (top-level window).  |
| <code>WinFlags</code>  | Window create flags. Typically <code>WM_CF_SHOW</code> in order to make the widget visible immediately (refer to <i>Window create flags</i> on page 977 for a list of available parameter values). |
| <code>ExFlags</code>   | See <i>ICONVIEW create flags</i> on page 1464.   |
| <code>Id</code>        | Window ID of the widget.   |
| <code>xSizeItem</code> | Horizontal icon size in pixels.  |
| <code>ySizeItem</code> | Vertical icon size in pixels.  |

#### Return value

Handle of the new widget, 0 if the function fails.

#### Additional information

If the widget should be transparent, the parameter `WinFlags` should be or-combined with `WM_CF_HASTRANS`.

#### 6.2.13.5.1.4 ICONVIEW\_CreateIndirect()

##### Description

The prototype of this function is explained at the beginning of this chapter. Details can be found in the description of the function `<WIDGET>_CreateIndirect()` on page 992.

The upper 16 bit of the element `Para` of the according `GUI_WIDGET_CREATE_INFO` structure are used according to the parameter `ySizeItems` of the function `ICONVIEW_CreateEx()`. The lower 16 bit of the element `Para` are used according to the parameter `xSizeItems` of the function `ICONVIEW_CreateEx()`. The element `Flags` is used according to the parameter `WinFlags` of the function `ICONVIEW_CreateEx()`.

### 6.2.13.5.1.5 ICONVIEW\_CreateUser()

#### Description

Prototype explained at the beginning of the chapter as `<WIDGET>_CreateUser()` on page 993. For a detailed description of the parameters the function `ICONVIEW_CreateEx()` can be referred to.

### 6.2.13.5.1.6 ICONVIEW\_DeleteItem()

#### Description

Deletes an existing item of the ICONVIEW widget.

#### Prototype

```
void ICONVIEW_DeleteItem(ICONVIEW_Handle hObj,  
                        unsigned Index);
```

#### Parameters

| Parameter             | Description                                      |
|-----------------------|--|
| <a href="#">hObj</a>  | Handle of ICONVIEW widget.                       |
| <a href="#">Index</a> | <a href="#">Index</a> of the item to be deleted. |

### 6.2.13.5.1.7 ICONVIEW\_EnableStreamAuto()

#### Description

Enables full support for streamed bitmaps.

#### Prototype

```
void ICONVIEW_EnableStreamAuto(void);
```

#### Additional information

The ICONVIEW widget supports only index based streamed bitmaps by default. Calling this function enables support for all kinds of streamed bitmaps. This causes all drawing functions for streamed bitmaps to be referenced by the linker.

### 6.2.13.5.1.8 ICONVIEW\_GetBkColor()

#### Description

Returns the background color of the widget.

#### Prototype

```
GUI_COLOR ICONVIEW_GetBkColor(ICONVIEW_Handle hObj,  
                               int Index);
```

#### Parameters

| Parameter             | Description   |
|-----------------------|---|
| <a href="#">hObj</a>  | Handle of ICONVIEW widget.  |
| <a href="#">Index</a> | See <i>ICONVIEW color indexes</i> on page 1463 for a full list of permitted values. |

#### Return value

The background color of the given widget.

### 6.2.13.5.1.9 ICONVIEW\_GetFont()

#### Description

Returns the font of the widget.

#### Prototype

```
GUI_FONT *ICONVIEW_GetFont(ICONVIEW_Handle hObj);
```

#### Parameters

| Parameter            | Description                |
|----------------------|----------------------------|
| <a href="#">hObj</a> | Handle of ICONVIEW widget. |

#### Return value

The font of the given widget.

### 6.2.13.5.1.10 ICONVIEW\_GetItemBitmap()

#### Description

Retrieves the bitmap of a specified ICONVIEW item.

#### Prototype

```
GUI_BITMAP *ICONVIEW_GetItemBitmap(ICONVIEW_Handle hObj,  
                                   int ItemIndex);
```

#### Parameters

| Parameter              | Description                   |
|------------------------|-------------------------------|
| <code>hObj</code>      | Handle of ICONVIEW widget.    |
| <code>ItemIndex</code> | Index of the item to be used. |

#### Return value

Pointer to the bitmap of the given item.



### 6.2.13.5.1.11 ICONVIEW\_GetItemText()

#### Description

Retrieves the text of a specified ICONVIEW item.

#### Prototype

```
int ICONVIEW_GetItemText(ICONVIEW_Handle hObj,  
                        int Index,  
                        char * pBuffer,  
                        int MaxSize);
```

#### Parameters

| Parameter               | Description                                      |
|-------------------------|--|
| <a href="#">hObj</a>    | Handle of ICONVIEW widget.                       |
| <a href="#">Index</a>   | <a href="#">Index</a> of the item to be deleted. |
| <a href="#">pBuffer</a> | Buffer to retrieve the text.                     |
| <a href="#">MaxSize</a> | Maximum length of text to copy to the buffer.    |

#### Return value

The length of the actually copied text is returned.

### 6.2.13.5.1.12 ICONVIEW\_GetItemUserData()

#### Description

Retrieves the previously stored user data from a specific item.

#### Prototype

```
U32 ICONVIEW_GetItemUserData(ICONVIEW_Handle hObj,  
                             int Index);
```

#### Parameters

| Parameter             | Description                        |
|-----------------------|------------------------------------|
| <a href="#">hObj</a>  | Handle of ICONVIEW widget.         |
| <a href="#">Index</a> | <a href="#">Index</a> of the item. |

#### Return value

User data stored in the item as U32.

### 6.2.13.5.1.13 ICONVIEW\_GetNumItems()

#### Description

Returns the number of items in the given ICONVIEW widget.

#### Prototype

```
int ICONVIEW_GetNumItems(ICONVIEW_Handle hObj);
```

#### Parameters

| Parameter            | Description                |
|----------------------|----------------------------|
| <a href="#">hObj</a> | Handle of ICONVIEW widget. |

#### Return value

Number of items.

### 6.2.13.5.1.14 ICONVIEW\_GetReleasedItem()

#### Description

This function returns the index of the released ICONVIEW item.

#### Prototype

```
int ICONVIEW_GetReleasedItem(ICONVIEW_Handle hObj);
```

#### Parameters

| Parameter            | Description                |
|----------------------|----------------------------|
| <a href="#">hObj</a> | Handle of ICONVIEW widget. |

#### Return value

Zero based index of last released item.

### 6.2.13.5.1.15 ICONVIEW\_GetSel()

#### Description

Returns the zero based index of the currently selected icon.

#### Prototype

```
int ICONVIEW_GetSel(ICONVIEW_Handle hObj);
```

#### Parameters

| Parameter            | Description                |
|----------------------|----------------------------|
| <a href="#">hObj</a> | Handle of ICONVIEW widget. |

#### Return value

Zero based index of the currently selected icon.

### 6.2.13.5.1.16 ICONVIEW\_GetTextColor()

#### Description

Returns the text color of the widget.

#### Prototype

```
GUI_COLOR ICONVIEW_GetTextColor(ICONVIEW_Handle hObj,  
                                int Index);
```

#### Parameters

| Parameter             | Description   |
|-----------------------|---|
| <a href="#">hObj</a>  | Handle of ICONVIEW widget.  |
| <a href="#">Index</a> | See <i>ICONVIEW color indexes</i> on page 1463 for a full list of permitted values. |

#### Return value

The text color of the given widget.

### 6.2.13.5.1.17 ICONVIEW\_GetUserData()

#### Description

Prototype explained at the beginning of the chapter as `<WIDGET>_GetUserData()` on page 994.

### 6.2.13.5.1.18 ICONVIEW\_InsertBitmapItem()

#### Description

Inserts a new bitmap icon to the widget.

#### Prototype

```
int ICONVIEW_InsertBitmapItem(    ICONVIEW_Handle  hObj,
                                const GUI_BITMAP      * pBitmap,
                                const char             * pText,
                                int                    Index);
```

#### Parameters

| Parameter               | Description   |
|-------------------------|---|
| <a href="#">hObj</a>    | Handle of ICONVIEW widget.                            |
| <a href="#">pBitmap</a> | Pointer to a bitmap structure used to draw the icon.  |
| <a href="#">pText</a>   | Text to be used to label the icon.                    |
| <a href="#">Index</a>   | <a href="#">Index</a> position to insert the item at. |

#### Return value

= 0      on success  
 ≠ 0      on error.

#### Additional information

See [ICONVIEW\\_AddBitmapItem\(\)](#) for screenshots. Note that the bitmap pointer needs to remain valid.



### 6.2.13.5.1.19 ICONVIEW\_InsertStreamedBitmapItem()

#### Description

Inserts a new streamed bitmap icon to the widget.

#### Prototype

```
int ICONVIEW_InsertStreamedBitmapItem(    ICONVIEW_Handle  hObj,
                                         const void        * pStreamedBitmap,
                                         const char        * pText,
                                         int                Index);
```

#### Parameters

| Parameter                       | Description   |
|---------------------------------|---|
| <a href="#">hObj</a>            | Handle of ICONVIEW widget.                            |
| <a href="#">pStreamedBitmap</a> | Pointer to a bitmap stream used to draw the icon.     |
| <a href="#">pText</a>           | Text to be used to label the icon.                    |
| <a href="#">Index</a>           | <a href="#">Index</a> position to insert the item at. |

#### Return value

= 0      on success  
 ≠ 0      on error.

#### Additional information

See [ICONVIEW\\_AddBitmapItem\(\)](#) for screenshots. The pointer to the bitmap stream needs to remain valid.

### 6.2.13.5.1.20 ICONVIEW\_OwnerDraw()

#### Description

Default function for drawing a ICONVIEW widget.

#### Prototype

```
int ICONVIEW_OwnerDraw(const WIDGET_ITEM_DRAW_INFO * pDrawItemInfo);
```

#### Parameters

| Parameter                  | Description                                   |
|----------------------------|---|
| <code>pDrawItemInfo</code> | Pointer to a WIDGET_ITEM_DRAW_INFO structure. |

#### Return value

Returns 0.

#### Additional information

This function is useful if `ICONVIEW_SetOwnerDraw()` has been used. It can be used from the custom drawing routine for managing all not handled commands. For more information please refer to `ICONVIEW_SetOwnerDraw()` on page 1454.

### 6.2.13.5.1.21 ICONVIEW\_SetBitmapItem()

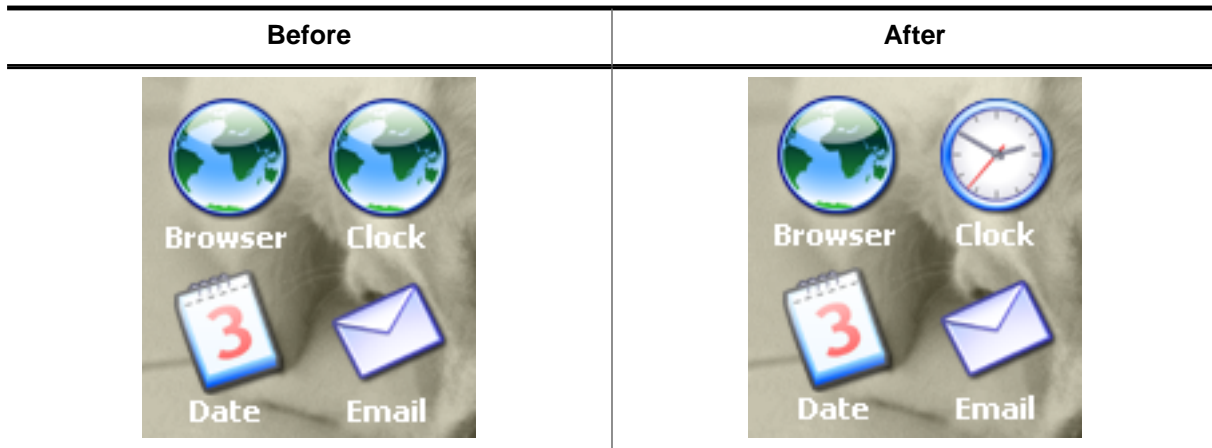

#### Description

Sets a bitmap to be used by a specific item.

#### Prototype

```
int ICONVIEW_SetBitmapItem(    ICONVIEW_Handle  hObj,
                               int                    Index,
                               const GUI_BITMAP      * pBitmap);
```

#### Parameters

| Parameter            | Description                       |
|----------------------|-----------------------------------|
| <code>hObj</code>    | Handle of ICONVIEW widget.        |
| <code>Index</code>   | <code>Index</code> of the item.   |
| <code>pBitmap</code> | Pointer to the bitmap to be used. |

#### Return value

Returns 0.

#### Additional information

The pointer to the bitmap structure needs to remain valid.

### 6.2.13.5.1.22 ICONVIEW\_SetBkColor()

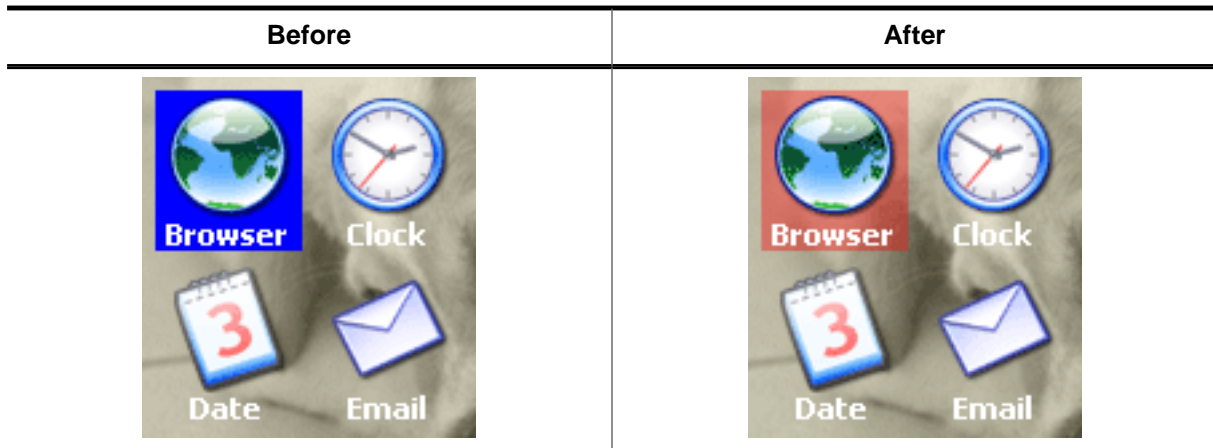

#### Description

Sets the background color of the widget.

#### Prototype

```
void ICONVIEW_SetBkColor(ICONVIEW_Handle hObj,
                        int Index,
                        GUI_COLOR Color);
```

#### Parameters

| Parameter          | Description   |
|--------------------|---|
| <code>hObj</code>  | Handle of ICONVIEW widget.  |
| <code>Index</code> | See <i>ICONVIEW color indexes</i> on page 1463 for a full list of permitted values. |
| <code>Color</code> | <code>Color</code> to be used for drawing the background.                           |

#### Additional information

The upper 8 bits of the 32 bit color value can be used for an alpha blending effect. For more details about alpha blending, refer to `GUI_SetAlpha()`.

### 6.2.13.5.1.23 ICONVIEW\_SetFont()

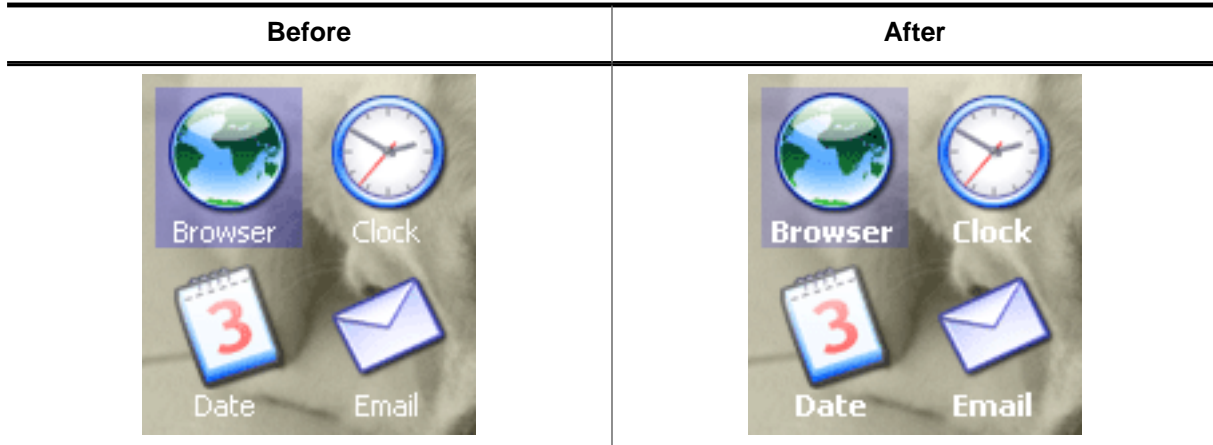

#### Description

Sets the font to be used for drawing the icon labels.

#### Prototype

```
void ICONVIEW_SetFont(    ICONVIEW_Handle  hObj,
                        const GUI_FONT    * pFont);
```

#### Parameters

| Parameter             | Description   |
|-----------------------|---|
| <a href="#">hObj</a>  | Handle of ICONVIEW widget.  |
| <a href="#">pFont</a> | Pointer to a GUI_FONT structure to be used to draw the icon labels. |

### 6.2.13.5.1.24 ICONVIEW\_SetFrame()

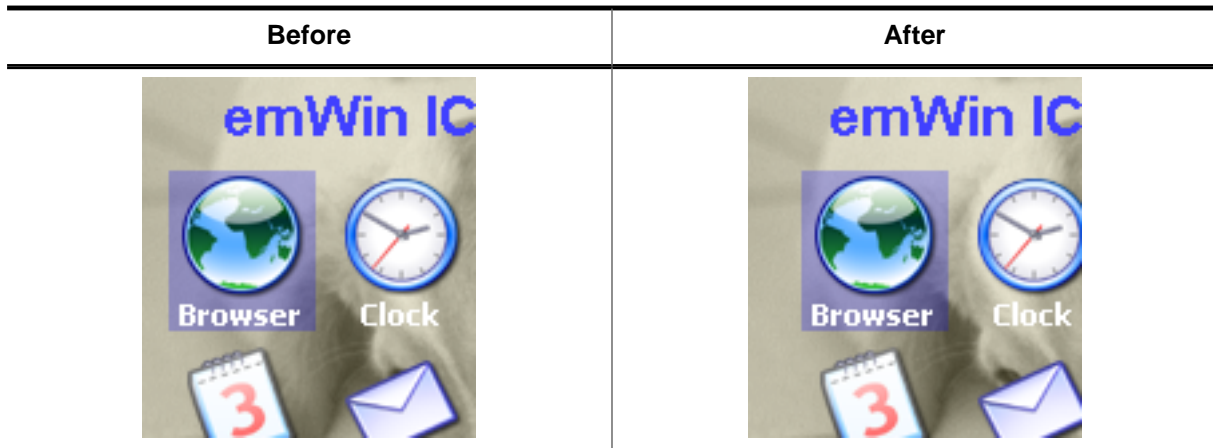

#### Description

Sets the size of the frame between the border of the widget and the icons.

#### Prototype

```
void ICONVIEW_SetFrame(ICONVIEW_Handle hObj,
                       int Coord,
                       int Value);
```

#### Parameters

| Parameter          | Description                                    |
|--------------------|--|
| <code>hObj</code>  | Handle of ICONVIEW widget.                     |
| <code>Coord</code> | See permitted values for this parameter below. |
| <code>Value</code> | Distance to be set.                            |

| Permitted values for parameter <code>Coord</code> |              |
|---|--------------|
| <code>GUI_COORD_X</code>                          | X-direction. |
| <code>GUI_COORD_Y</code>                          | Y-direction. |

### 6.2.13.5.1.25 ICONVIEW\_SetIconAlign()

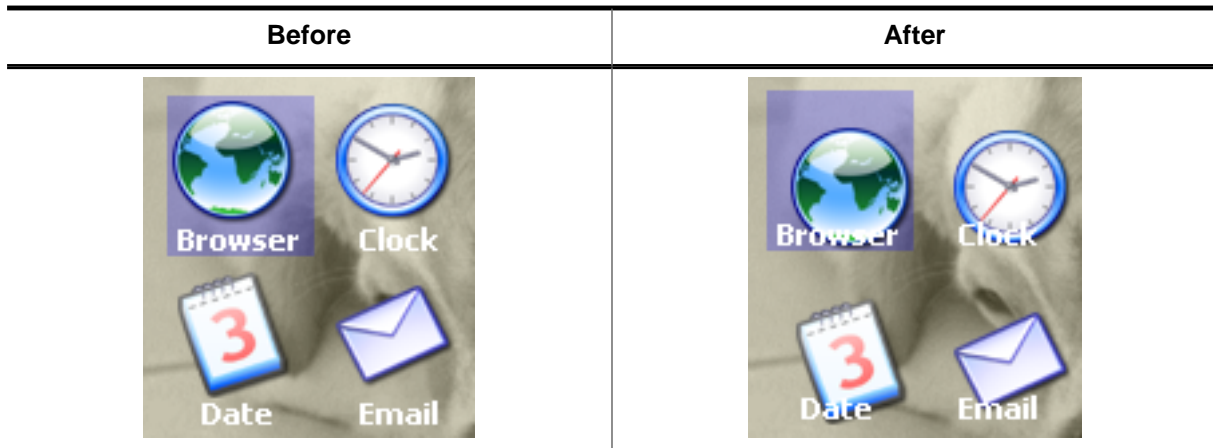

#### Description

Sets the icon alignment.

#### Prototype

```
void ICONVIEW_SetIconAlign(ICONVIEW_Handle hObj,
                           int             IconAlign);
```

#### Parameters

| Parameter              | Description   |
|------------------------|---|
| <code>hObj</code>      | Handle of ICONVIEW widget.  |
| <code>IconAlign</code> | Alignment of the icons. See <i>ICONVIEW alignment flags</i> on page 1462. |

### 6.2.13.5.1.26 ICONVIEW\_SetItemText()

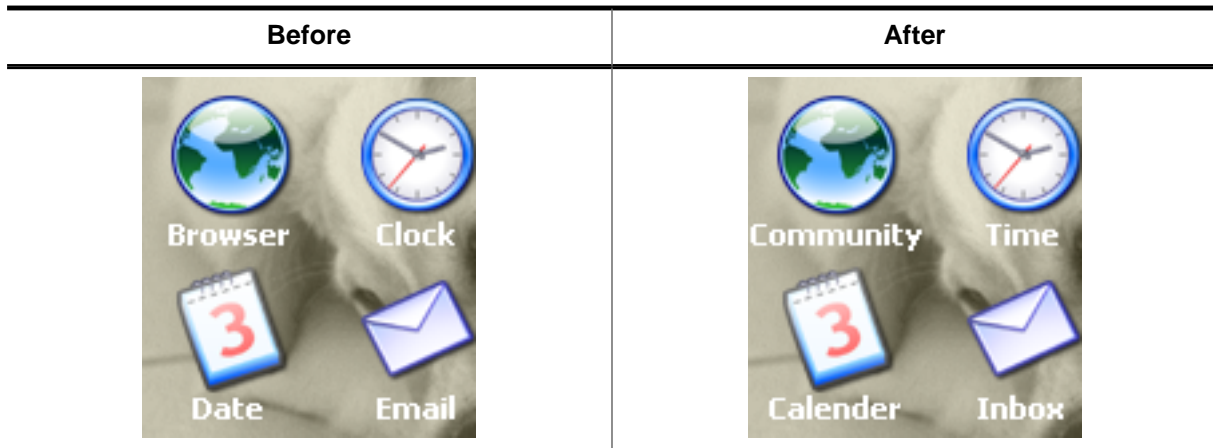

#### Description

Sets the text of a specific item.

#### Prototype

```
void ICONVIEW_SetItemText(    ICONVIEW_Handle  hObj,
                             int                Index,
                             const char        * s);
```

#### Parameters

| Parameter          | Description                     |
|--------------------|---------------------------------|
| <code>hObj</code>  | Handle of ICONVIEW widget.      |
| <code>Index</code> | <code>Index</code> of the item. |
| <code>pText</code> | Pointer to the text to be used. |



### 6.2.13.5.1.27 ICONVIEW\_SetItemUserData()

#### Description

Stores user data in a specific item.

#### Prototype

```
void ICONVIEW_SetItemUserData(ICONVIEW_Handle hObj,  
                             int Index,  
                             U32 UserData);
```

#### Parameters

| Parameter                | Description                        |
|--------------------------|------------------------------------|
| <a href="#">hObj</a>     | Handle of ICONVIEW widget.         |
| <a href="#">Index</a>    | <a href="#">Index</a> of the item. |
| <a href="#">UserData</a> | 32 bit user data to be stored.     |

### 6.2.13.5.1.28 ICONVIEW\_SetOwnerDraw()

#### Description

Sets an application defined owner draw function for the widget which is responsible for drawing the widget.

#### Prototype

```
void ICONVIEW_SetOwnerDraw(ICONVIEW_Handle      hObj,
                           WIDGET_DRAW_ITEM_FUNC * pfDrawItem);
```

#### Parameters

| Parameter                | Description                     |
|--------------------------|---------------------------------|
| <code>hObj</code>        | Handle of ICONVIEW widget.      |
| <code>pfOwnerDraw</code> | Pointer to owner draw function. |

#### Supported commands

- WIDGET\_ITEM\_CREATE
- WIDGET\_DRAW\_BACKGROUND
- WIDGET\_ITEM\_DRAW\_BACKGROUND
- WIDGET\_ITEM\_DRAW\_BITMAP
- WIDGET\_ITEM\_DRAW\_TEXT

#### Additional information

This function sets a pointer to an application defined function which will be called by the widget when a data item has to be drawn or when the x or y size of a item is needed. `pfDrawItem` is a pointer to an application-defined function of type `WIDGET_DRAW_ITEM_FUNC` which is explained at the beginning of the chapter.

#### Example

The following example uses a bitmap for drawing the widget background:

```
static int _OwnerDraw(const WIDGET_ITEM_DRAW_INFO * pDrawItemInfo) {
    switch (pDrawItemInfo->Cmd) {
        case WIDGET_DRAW_BACKGROUND:
            GUI_DrawBitmap(&Bitmap, 0, 0);
            break;
        default:
            return ICONVIEW_OwnerDraw(pDrawItemInfo);
    }
    return 0;
}
```

### 6.2.13.5.1.29 ICONVIEW\_SetSel()

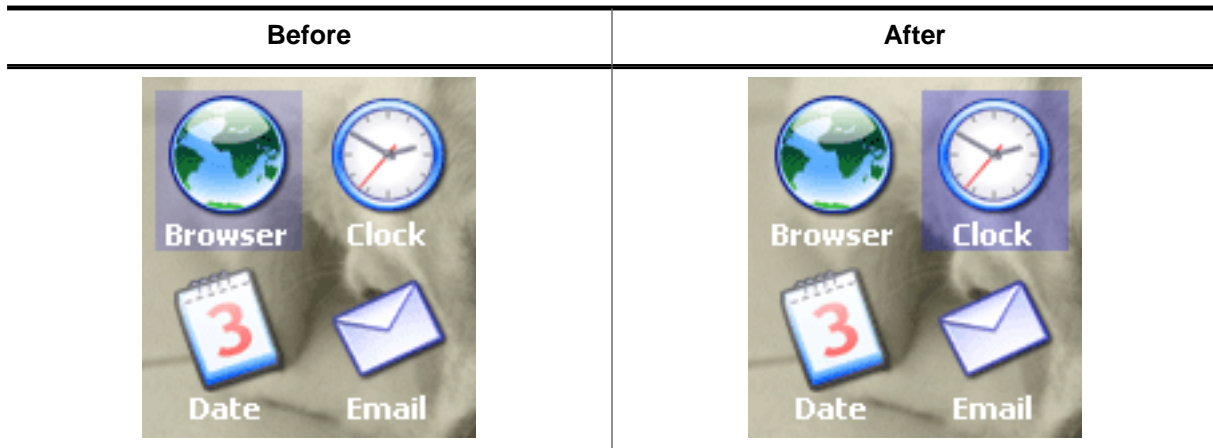

#### Description

Sets the current selection.

#### Prototype

```
void ICONVIEW_SetSel(ICONVIEW_Handle hObj,
                    int Sel);
```

#### Parameters

| Parameter         | Description                |
|-------------------|----------------------------|
| <code>hObj</code> | Handle of ICONVIEW widget. |
| <code>Sel</code>  | New selection.             |

### 6.2.13.5.1.30 ICONVIEW\_SetSpace()

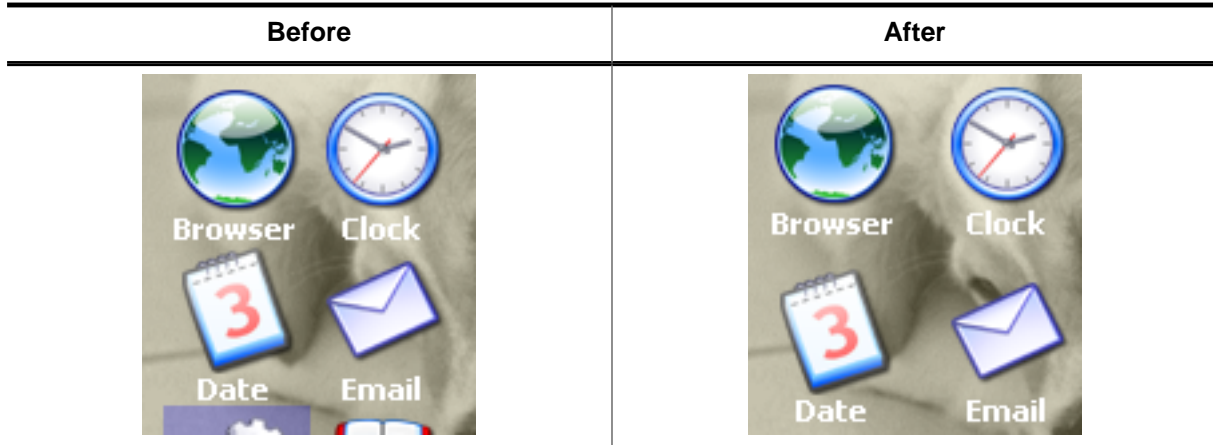

#### Description

Sets the space between icons in x- or y-direction.

#### Prototype

```
void ICONVIEW_SetSpace(ICONVIEW_Handle hObj,
                      int Coord,
                      int Value);
```

#### Parameters

| Parameter          | Description                                    |
|--------------------|--|
| <code>hObj</code>  | Handle of ICONVIEW widget.                     |
| <code>Coord</code> | See permitted values for this parameter below. |
| <code>Value</code> | Distance to be set.                            |

| Permitted values for parameter <code>Coord</code> |              |
|---|--------------|
| <code>GUI_COORD_X</code>                          | X-direction. |
| <code>GUI_COORD_Y</code>                          | Y-direction. |

### 6.2.13.5.1.31 ICONVIEW\_SetStreamedBitmapItem()

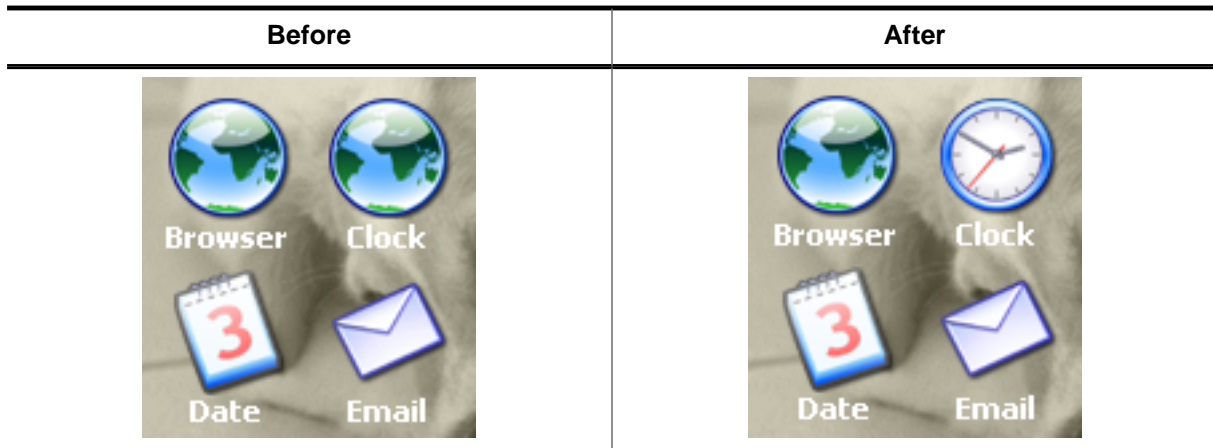

#### Description

Sets a streamed bitmap to be used by a specific item.

#### Prototype

```
int ICONVIEW_SetStreamedBitmapItem(    ICONVIEW_Handle  hObj,
                                       int                Index,
                                       const void          * pStreamedBitmap);
```

#### Parameters

| Parameter                    | Description                              |
|------------------------------|--|
| <code>hObj</code>            | Handle of ICONVIEW widget.               |
| <code>Index</code>           | <code>Index</code> of the item.          |
| <code>pStreamedBitmap</code> | Pointer to the bitmap stream to be used. |

#### Additional information

The pointer to the bitmap stream needs to remain valid.

### 6.2.13.5.1.32 ICONVIEW\_SetTextAlign()

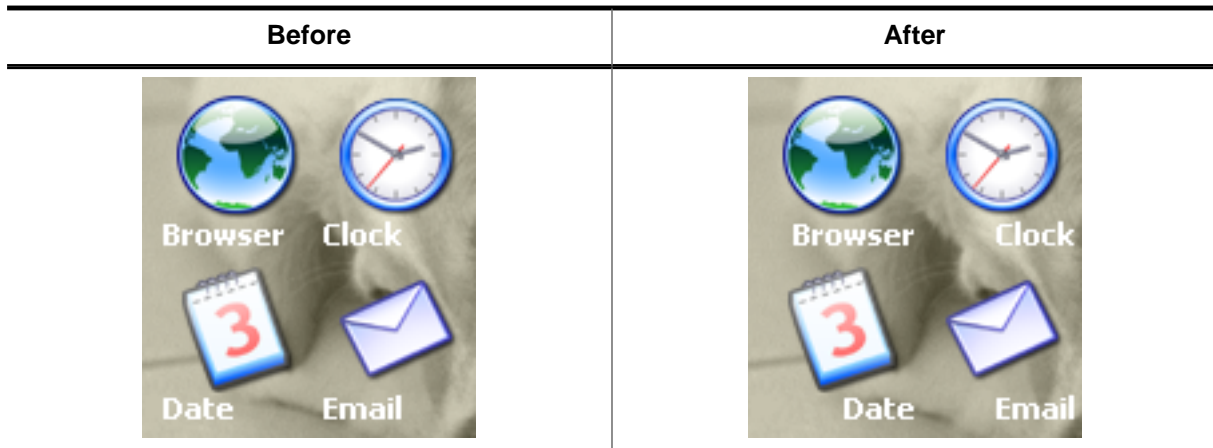

#### Description

Sets the text align of the item texts.

#### Prototype

```
void ICONVIEW_SetTextAlign(ICONVIEW_Handle hObj,
                           int TextAlign);
```

#### Parameters

| Parameter              | Description  |
|------------------------|--|
| <code>hObj</code>      | Handle of ICONVIEW widget.   |
| <code>TextAlign</code> | Text alignment mode. List of flags can be found under <i>Text alignment flags</i> on page 252. |

### 6.2.13.5.1.33 ICONVIEW\_SetTextColor()

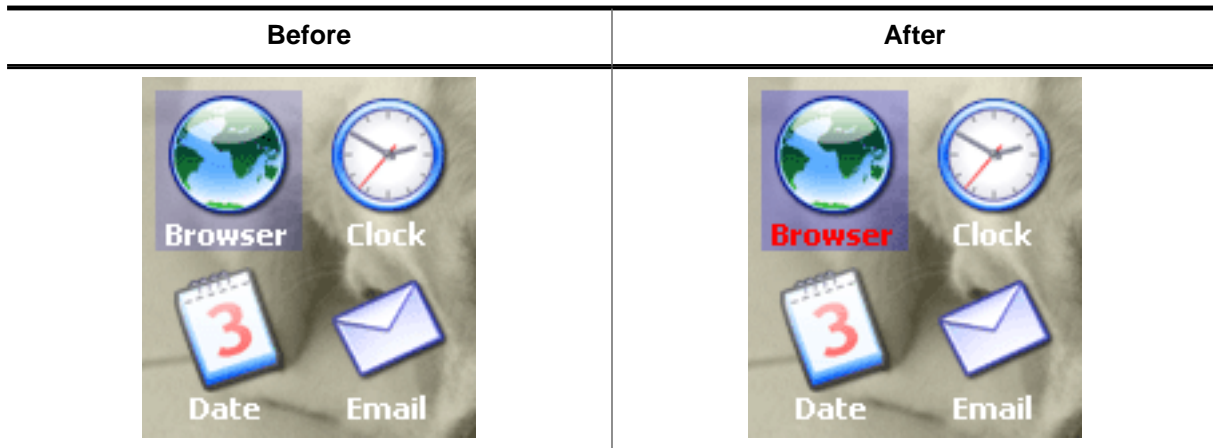

#### Description

Sets the color to be used to draw the labels.

#### Prototype

```
void ICONVIEW_SetTextColor(ICONVIEW_Handle hObj,
                           int           Index,
                           GUI_COLOR     Color);
```

#### Parameters

| Parameter          | Description   |
|--------------------|---|
| <code>hObj</code>  | Handle of <i>ICONVIEW</i> widget.   |
| <code>Index</code> | See <i>ICONVIEW color indexes</i> on page 1463 for a full list of permitted values. |
| <code>Color</code> | <code>Color</code> to be used   |

#### 6.2.13.5.1.34 ICONVIEW\_SetUserData()

##### **Description**

Prototype explained at the beginning of the chapter as `<WIDGET>_SetUserData()` on page 995.



### 6.2.13.5.1.35 ICONVIEW\_SetWrapMode()

#### Description

Sets the wrapping mode to be used for the given ICONVIEW widget.

#### Prototype

```
void ICONVIEW_SetWrapMode(ICONVIEW_Handle hObj,  
                           GUI_WRAPMODE  WrapMode);
```

#### Parameters

| Parameter                | Description                |
|--------------------------|----------------------------|
| <a href="#">hObj</a>     | Handle of ICONVIEW widget. |
| <a href="#">WrapMode</a> | See table below.           |

## 6.2.13.5.2 Defines

### 6.2.13.5.2.1 ICONVIEW alignment flags

#### Description

Alignment flags similar to the Text alignment flags used for aligning the icons of an ICONVIEW widget using the routine `ICONVIEW_SetIconAlign()`. These flags are also OR-combinable.

#### Definition

```
#define ICONVIEW_IA_HCENTER    (0 << 0)
#define ICONVIEW_IA_LEFT      (1 << 0)
#define ICONVIEW_IA_RIGHT     (2 << 0)
#define ICONVIEW_IA_VCENTER   (0 << 2)
#define ICONVIEW_IA_BOTTOM    (1 << 2)
#define ICONVIEW_IA_TOP       (2 << 2)
```

#### Symbols

| Definition                       | Description                                      |
|----------------------------------|--|
| Horizontal alignment             |  |
| <code>ICONVIEW_IA_LEFT</code>    | Align X-position left.                           |
| <code>ICONVIEW_IA_HCENTER</code> | Center X-position. (default)                     |
| <code>ICONVIEW_IA_RIGHT</code>   | Align X-position right.                          |
| Vertical alignment               |  |
| <code>ICONVIEW_IA_TOP</code>     | Align Y-position with top of characters.         |
| <code>ICONVIEW_IA_VCENTER</code> | Center Y-position. (default)                     |
| <code>ICONVIEW_IA_BOTTOM</code>  | Align Y-position with bottom pixel line of font. |

### 6.2.13.5.2 ICONVIEW color indexes

#### Description

Color indexes used by the ICONVIEW widget.

#### Definition

```
#define ICONVIEW_CI_BK          0
#define ICONVIEW_CI_UNSEL     0
#define ICONVIEW_CI_SEL       1
#define ICONVIEW_CI_DISABLED  2
```

#### Symbols

| Definition                           | Description                               |
|--------------------------------------|---|
| <a href="#">ICONVIEW_CI_BK</a>       | Color used to draw the widget background. |
| <a href="#">ICONVIEW_CI_UNSEL</a>    | Color of an unselected item.              |
| <a href="#">ICONVIEW_CI_SEL</a>      | Color of a selected item.                 |
| <a href="#">ICONVIEW_CI_DISABLED</a> | Color used in disabled state.             |

#### Additional information

[ICONVIEW\\_CI\\_BK](#) is only used by the routines `ICONVIEW_GetBkColor()` and `ICONVIEW_SetBkColor()` instead of `ICONVIEW_CI_UNSEL`.

### 6.2.13.5.2.3 ICONVIEW create flags

#### Description

Create flags for the ICONVIEW widget. These flags can be passed to `ICONVIEW_CreateEx()` via the `ExFlags` parameter.

#### Definition

```
#define ICONVIEW_CF_AUTOSCROLLBAR_V    (1 << 1)
```

#### Symbols

| Definition                               | Description  |
|--|--|
| <code>ICONVIEW_CF_AUTOSCROLLBAR_V</code> | A vertical scroll bar will be added if the widget area is too small to show all icons. |

### 6.2.13.6 Example

The `Sample` folder contains the following example which shows how the widget can be used:

- `WIDGET_IconView.c`

**Screenshot of `WIDGET_Iconview.c`:**

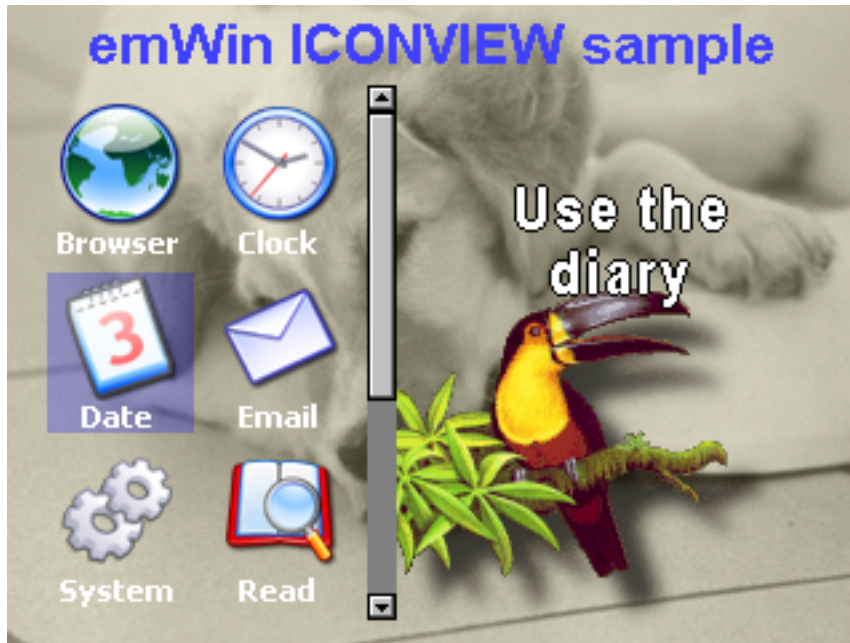

## 6.2.14 IMAGE: Image widget

IMAGE widgets are used to display images of different formats from internal as well as from external memory.

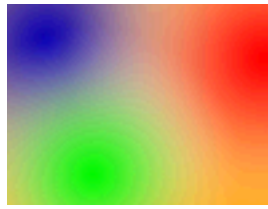

### Note

All IMAGE-related routines are located in the file(s) `IMAGE*.c`, `IMAGE.h`.  
All identifiers are prefixed `IMAGE`.

### 6.2.14.1 Configuration options

The IMAGE widget can be configured using an OR-combination of flags as `ExFlags`-parameter at creation. A full list of flags can be found under *IMAGE create flags* on page 1484.

### 6.2.14.2 Predefined IDs

The following symbols define IDs which may be used to make IMAGE widgets distinguishable from creation.

```
#define GUI_ID_IMAGE0      0x270
#define GUI_ID_IMAGE1      0x271
#define GUI_ID_IMAGE2      0x272
#define GUI_ID_IMAGE3      0x273
#define GUI_ID_IMAGE4      0x274
#define GUI_ID_IMAGE5      0x275
#define GUI_ID_IMAGE6      0x276
#define GUI_ID_IMAGE7      0x277
#define GUI_ID_IMAGE8      0x278
#define GUI_ID_IMAGE9      0x279
```

### 6.2.14.3 Notification codes

The following events are sent from an IMAGE widget to its parent window as part of a `WM_NOTIFY_PARENT` message:

| Message                                | Description  |
|--|--|
| <code>WM_NOTIFICATION_CLICKED</code>   | The widget has been clicked.   |
| <code>WM_NOTIFICATION_RELEASED</code>  | The widget has been released.  |
| <code>WM_NOTIFICATION_MOVED_OUT</code> | The pointer was moved out of the widget area while the PID was in pressed state. |

## 6.2.14.4 IMAGE API

The table below lists the available IMAGE-related routines in alphabetical order. Detailed descriptions of the routines follow.

### Functions

| Routine                                | Description   |
|--|---|
| <a href="#">IMAGE_CreateEx()</a>       | Creates an IMAGE widget.  |
| <a href="#">IMAGE_CreateIndirect()</a> | Creates a IMAGE widget from a resource table entry.               |
| <a href="#">IMAGE_CreateUser()</a>     | Creates a IMAGE widget using extra bytes as user data.            |
| <a href="#">IMAGE_EnableLQ()</a>       | Enables low-quality mode for the IMAGE widget.                    |
| <a href="#">IMAGE_GetImageSize()</a>   | Returns the X- and Y-size of the image set to the widget.         |
| <a href="#">IMAGE_GetUserData()</a>    | Retrieves the data set with <a href="#">IMAGE_SetUserData()</a> . |
| <a href="#">IMAGE_SetAlign()</a>       | Sets an alignment to the widget's image.                          |
| <a href="#">IMAGE_SetAlpha()</a>       | Blends the image with an alpha value.                             |
| <a href="#">IMAGE_SetAngle()</a>       | Rotates the image by a given angle.                               |
| <a href="#">IMAGE_SetBitmap()</a>      | Sets a bitmap to be displayed.                                    |
| <a href="#">IMAGE_SetBMP()</a>         | Sets a BMP file to be displayed.                                  |
| <a href="#">IMAGE_SetBMPEX()</a>       | Sets a BMP file to be displayed from external memory.             |
| <a href="#">IMAGE_SetDTA()</a>         | Sets a DTA file to be displayed.                                  |
| <a href="#">IMAGE_SetDTAEX()</a>       | Sets a DTA file to be displayed from external memory.             |
| <a href="#">IMAGE_SetGIF()</a>         | Sets a GIF file to be displayed.                                  |
| <a href="#">IMAGE_SetGIFEX()</a>       | Sets a GIF file to be displayed from external memory.             |
| <a href="#">IMAGE_SetJPEG()</a>        | Sets a JPEG file to be displayed.                                 |
| <a href="#">IMAGE_SetJPEGEX()</a>      | Sets a JPEG file to be displayed from external memory.            |
| <a href="#">IMAGE_SetOffset()</a>      | Sets an X- and Y-offset to the widget's image.                    |
| <a href="#">IMAGE_SetPNG()</a>         | Sets a PNG file to be displayed.                                  |
| <a href="#">IMAGE_SetPNGEX()</a>       | Sets a PNG file to be displayed from external memory.             |
| <a href="#">IMAGE_SetScale()</a>       | Scales the image by a given factor.                               |
| <a href="#">IMAGE_SetTiled()</a>       | Enables tiled mode for an IMAGE widget.                           |
| <a href="#">IMAGE_SetUserData()</a>    | Sets the extra data of an IMAGE widget.                           |

### Defines

| Group of defines                   | Description                          |
|------------------------------------|--------------------------------------|
| <a href="#">IMAGE_create_flags</a> | Create flags used for IMAGE widgets. |

## 6.2.14.4.1 Functions

### 6.2.14.4.1.1 IMAGE\_CreateEx()

#### Description

Creates an IMAGE widget of a specified size at a specified location.

#### Prototype

```
IMAGE_Handle IMAGE_CreateEx(int    x0,
                             int    y0,
                             int    xSize,
                             int    ySize,
                             WM_HWIN hParent,
                             int    WinFlags,
                             int    ExFlags,
                             int    Id);
```

#### Parameters

| Parameter             | Description  |
|-----------------------|--|
| <code>x0</code>       | Leftmost pixel of the widget (in parent coordinates).  |
| <code>y0</code>       | Topmost pixel of the widget (in parent coordinates).   |
| <code>xSize</code>    | Horizontal size of the widget (in pixels).   |
| <code>ySize</code>    | Vertical size of the widget (in pixels).   |
| <code>hParent</code>  | Handle of parent window. If 0, the IMAGE widget will be a child of the desktop (top-level window).   |
| <code>WinFlags</code> | Window create flags. Typically <code>WM_CF_SHOW</code> in order to make the widget visible immediately (refer to <i>Window create flags</i> on page 977 for a list of available parameter values). |
| <code>ExFlags</code>  | See <i>IMAGE create flags</i> on page 1484.  |
| <code>Id</code>       | Window ID of the widget.   |

#### Return value

Handle of the created IMAGE widget; 0 if the function fails.

#### Additional information

If the possibility of storing user data is a matter the function `IMAGE_CreateUser()` should be used instead.



#### 6.2.14.4.1.2 IMAGE\_CreateIndirect()

##### Description

The prototype of this function is explained at the beginning of this chapter. For details the function `<WIDGET>_CreateIndirect()` on page 992 should be referred to. The element `Flags` is used according to the parameter `WinFlags` of the function `IMAGE_CreateEx()`. The element `Para` is used according to the parameter `ExFlags` of the function `IMAGE_CreateEx()`. For a detailed description of the parameters the function `IMAGE_CreateEx()` can be referred to.

### 6.2.14.4.1.3 IMAGE\_CreateUser()

#### Description

Prototype explained at the beginning of the chapter as `<WIDGET>_CreateUser()` on page 993. For a detailed description of the parameters the function `IMAGE_CreateEx()` can be referred to.

#### 6.2.14.4.1.4 IMAGE\_EnableLQ()

##### Description

Enables low-quality mode for the IMAGE widget. This ensures a faster performance for rotating the image with `IMAGE_Rotate()`, but results in a lower image quality.

##### Prototype

```
void IMAGE_EnableLQ(IMAGE_Handle hObj,  
                   int           OnOff);
```

##### Parameters

| Parameter          | Description                      |
|--------------------|----------------------------------|
| <code>hObj</code>  | Handle of IMAGE widget.          |
| <code>OnOff</code> | 1 for enabling, 0 for disabling. |

### 6.2.14.4.1.5 IMAGE\_GetImageSize()

#### Description

Returns the X- and Y-size of the image set to the widget.

#### Prototype

```
int IMAGE_GetImageSize(IMAGE_Handle hObj,  
                       int          * pxSize,  
                       int          * pySize);
```

#### Parameters

| Parameter           | Description                                |
|---------------------|--|
| <code>hObj</code>   | Handle of IMAGE widget.                    |
| <code>pxSize</code> | Pointer to an integer to store the X-size. |
| <code>pySize</code> | Pointer to an integer to store the Y-size. |

#### Return value

0        On success.  
1        On error.

#### 6.2.14.4.1.6 IMAGE\_GetUserData()

##### **Description**

Prototype explained at the beginning of the chapter as `<WIDGET>_GetUserData()` on page 994.

### 6.2.14.4.1.7 IMAGE\_SetAlign()

#### Description

Sets an alignment to the widget's image.

#### Prototype

```
void IMAGE_SetAlign(IMAGE_Handle hObj,  
                   int           Align);
```

#### Parameters

| Parameter             | Description             |
|-----------------------|-------------------------|
| <a href="#">hObj</a>  | Handle of IMAGE widget. |
| <a href="#">Align</a> | Alignment of the image. |

### 6.2.14.4.1.8 IMAGE\_SetAlpha()

#### Description

Blends the image with an alpha value.

#### Prototype

```
U8 IMAGE_SetAlpha(IMAGE_Handle hObj,  
                  U8           Alpha);
```

#### Parameters

| Parameter             | Description                          |
|-----------------------|--------------------------------------|
| <a href="#">hObj</a>  | Handle of IMAGE widget.              |
| <a href="#">Alpha</a> | <a href="#">Alpha</a> value (0-255). |

#### Return value

Old alpha value.

### 6.2.14.4.1.9 IMAGE\_SetAngle()

#### Description

Rotates the image by a given angle.

#### Prototype

```
int IMAGE_SetAngle(IMAGE_Handle hObj,  
                  unsigned Angle);
```

#### Parameters

| Parameter             | Description  |
|-----------------------|--|
| <a href="#">hObj</a>  | Handle of IMAGE widget.  |
| <a href="#">Angle</a> | <a href="#">Angle</a> in degrees * 1000 (e.g. 45000 equals 45°). |

#### Return value

Old angle.



#### 6.2.14.4.1.10 IMAGE\_SetBitmap()

##### Description

Sets a bitmap to be displayed.

##### Prototype

```
void IMAGE_SetBitmap(      IMAGE_Handle  hObj,  
                        const GUI_BITMAP * pBitmap);
```

##### Parameters

| Parameter            | Description             |
|----------------------|-------------------------|
| <code>hWin</code>    | Handle of IMAGE widget. |
| <code>pBitmap</code> | Pointer to the bitmap.  |

**6.2.14.4.1.11 IMAGE\_SetBMP()****6.2.14.4.1.12 IMAGE\_SetDTA()****6.2.14.4.1.13 IMAGE\_SetGIF()****6.2.14.4.1.14 IMAGE\_SetJPEG()****6.2.14.4.1.15 IMAGE\_SetPNG()****Description**

These functions set a file of one of the formats listed below to be displayed:

- BMP
- DTA
- GIF
- JPEG
- PNG

**Prototype**

```
void IMAGE_Set<FORMAT>(      IMAGE_Handle hObj,
                           const void * pData,
                           U32      FileSize);
```

**Parameters**

| Parameter             | Description                |
|-----------------------|----------------------------|
| <code>hObj</code>     | Handle of IMAGE widget.    |
| <code>pData</code>    | Pointer to the IMAGE data. |
| <code>FileSize</code> | Size of the IMAGE data.    |

**Additional information**

The PNG functionality requires the PNG library which can be downloaded from [www.segger.com](http://www.segger.com). Animated GIF files are displayed automatically. Please make sure that each sub image of a GIF file replaces the previous one.

With a photo editing tool, such as GIMP, it is possible to convert a GIF file into the proper format. Follow these steps to create such a GIF file with GIMP:

1. Open the GIF file
2. On the menu bar click **Filters → Animation → Unoptimize**
3. Export as GIF

**6.2.14.4.1.16 IMAGE\_SetBMPEX()****6.2.14.4.1.17 IMAGE\_SetDTAEX()****6.2.14.4.1.18 IMAGE\_SetGIFEX()****6.2.14.4.1.19 IMAGE\_SetJPEGEX()****6.2.14.4.1.20 IMAGE\_SetPNGEX()****Description**

These functions set a file of one of the formats listed below to be displayed from external memory:

- BMP
- DTA
- GIF
- JPEG
- PNG

**Prototype**

```
void IMAGE_Set<FORMAT>EX(IMAGE_Handle      hObj,  
                          GUI_GET_DATA_FUNC * pfGetData,  
                          void              * pVoid);
```

**Additional information**

The PNG functionality requires the PNG library which can be downloaded from [www.segger.com](http://www.segger.com). Animated GIF files are displayed automatically.

#### 6.2.14.4.1.21 IMAGE\_SetOffset()

##### Description

Sets an X- and Y-offset to the widget's image.

##### Prototype

```
void IMAGE_SetOffset(IMAGE_Handle hObj,  
                    int           xOff,  
                    int           yOff);
```

##### Parameters

| Parameter            | Description             |
|----------------------|-------------------------|
| <a href="#">hObj</a> | Handle of IMAGE widget. |
| <a href="#">xOff</a> | X-offset set to image.  |
| <a href="#">yOff</a> | Y-offset set to image.  |

### 6.2.14.4.1.22 IMAGE\_SetScale()

#### Description

Scales the image by a given factor.

#### Prototype

```
int IMAGE_SetScale(IMAGE_Handle hObj,  
                  unsigned      Scale);
```

#### Parameters

| Parameter             | Description                                 |
|-----------------------|---|
| <a href="#">hObj</a>  | Handle of IMAGE widget.                     |
| <a href="#">Scale</a> | Factor * 1000 (e.g. 2000 equals 200% scale) |

#### Return value

Old scale value.

### 6.2.14.4.1.23 IMAGE\_SetTiled()

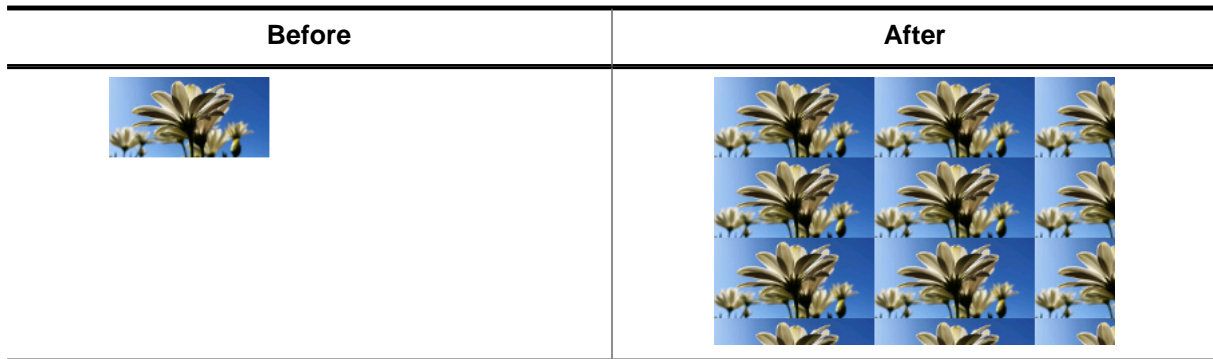

#### Description

Enables tiled mode for an IMAGE widget. With tiled mode, the entire area of the widget is filled with the set image, even if the image is smaller than the widget area.

#### Prototype

```
void IMAGE_SetTiled(IMAGE_Handle hObj,
                   int           OnOff);
```

#### Parameters

| Parameter | Description                                    |
|-----------|--|
| hObj      | Handle of IMAGE widget.                        |
| OnOff     | 1 for enabling tiled mode, 0 for disabling it. |

#### 6.2.14.4.1.24 IMAGE\_SetUserData()

##### Description

Prototype explained at the beginning of the chapter as `<WIDGET>_SetUserData()` on page 995.

## 6.2.14.4.2 Defines

### 6.2.14.4.2.1 IMAGE create flags

#### Description

Create flags for the IMAGE widget. These flags can be passed to `ICONVIEW_CreateEx()` via the `ExFlags` parameter.

#### Definition

```
#define IMAGE_CF_MEMDEV      (1 << 0)
#define IMAGE_CF_TILE       (1 << 1)
#define IMAGE_CF_ALPHA      (1 << 2)
#define IMAGE_CF_ATTACHED   (1 << 3)
#define IMAGE_CF_AUTOSIZE   (1 << 4)
#define IMAGE_CF_LQ        (1 << 5)
```

#### Symbols

| Definition                     | Description  |
|--------------------------------|--|
| <code>IMAGE_CF_MEMDEV</code>   | Makes the IMAGE widget use an internal Memory Device for drawing. Contrary to the Memory Device which is created by the Window Manager's automatic use of Memory Devices ( <code>WM_CF_MEMDEV</code> ), this device stays valid all the time. It has to be ensured that the emWin memory pool which is defined by the function <code>GUI_ALLOC_AssignMemory()</code> (in <code>GUIConf.c</code> ), is big enough to store the complete data. If the Memory Device can not be created, the image is drawn directly. This might possibly mean loss of performance. |
| <code>IMAGE_CF_TILE</code>     | Uses tiling to fill up the whole area of the widget.   |
| <code>IMAGE_CF_ALPHA</code>    | Needs to be set if alpha blending is required (PNG).   |
| <code>IMAGE_CF_ATTACHED</code> | Widget size is fixed to the parent border.   |
| <code>IMAGE_CF_AUTOSIZE</code> | Widget size is taken from the attached image.  |
| <code>IMAGE_CF_LQ</code>       | Fast mode (lower quality) should be used for rotating/scaling.   |



## 6.2.15 KEYBOARD: Keyboard widget

The KEYBOARD widget offers a fully configurable screen keyboard to enter characters. With more and more embedded targets having touch screens and using smartphone-like interfaces, the KEYBOARD widget fits right in being similar in appearance and usage to a typical smartphone keyboard.

To keep the positioning of the individual keys as simple as possible, keys can be added as whole key lines, that are scaled to the size of the widget automatically. The widget also enables the use of long press keys, much like with most smartphone keyboards. This way, it is possible to access even dozens of characters by only pressing one key.

### Note

All KEYBOARD-related routines are located in the file(s) `KEYBOARD.c`, `KEYBOARD.h`.

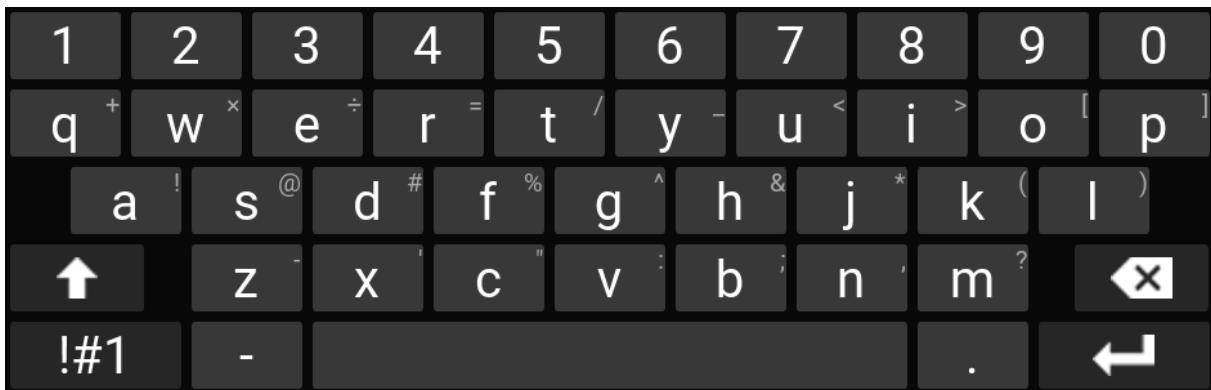

### 6.2.15.1 Configuration options

| Type | Macro                          | Default                  | Description   |
|------|--------------------------------|--------------------------|---|
| N    | KEYBOARD_COLOR_KEY_DEFAULT     | GUI_MAKE_COLOR(0x383838) | Color used for keys.  |
| N    | KEYBOARD_COLOR_PRESSED_DEFAULT | GUI_GRAY_60              | Pressed color of keys.  |
| N    | KEYBOARD_COLOR_FKEY_DEFAULT    | GUI_MAKE_COLOR(0x262626) | Color of function key, such as shift.                           |
| N    | KEYBOARD_COLOR_CODE_DEFAULT    | GUI_WHITE                | Text color of key.  |
| N    | KEYBOARD_COLOR_LONG_DEFAULT    | GUI_GRAY_AA              | Text color of long press character on a key.                    |
| N    | KEYBOARD_BKCOLOR_DEFAULT       | GUI_MAKE_COLOR(0x080808) | Background color of keyboard.                                   |
| N    | KEYBOARD_BKCOLOR_SHIFTLOCK     | GUI_MAKE_COLOR(0xFE9741) | Color of shift lock symbol.                                     |
| N    | KEYBOARD_FRAMERADIUS_DEFAULT   | 3                        | Radius of frame used for a key.                                 |
| N    | KEYBOARD_FRAMESIZE_DEFAULT     | 0                        | Size of frame used for a key.                                   |
| N    | KEYBOARD_SPACEX_DEFAULT        | 8                        | Total space in X between the keys.                              |
| N    | KEYBOARD_SPACEY_DEFAULT        | 8                        | Total space in Y between the keys.                              |
| N    | KEYBOARD_PERIOD_DEFAULT        | 200                      | Period for a longpress.   |
| N    | KEYBOARD_PERIOD_REPEAT_DEFAULT | 50                       | Period for repeated actions, such as holding the backspace key. |

## 6.2.15.2 Predefined IDs

The following symbols define IDs which may be used to make KEYBOARD widgets distinguishable from creation.

```
#define GUI_ID_KEYBOARD0    0x360
#define GUI_ID_KEYBOARD1    0x361
#define GUI_ID_KEYBOARD2    0x362
#define GUI_ID_KEYBOARD3    0x363
#define GUI_ID_KEYBOARD4    0x364
#define GUI_ID_KEYBOARD5    0x365
#define GUI_ID_KEYBOARD6    0x366
#define GUI_ID_KEYBOARD7    0x367
#define GUI_ID_KEYBOARD8    0x368
#define GUI_ID_KEYBOARD9    0x369
```

## 6.2.15.3 Keyboard reaction





The widget can not gain the input focus and does not react on keyboard input.

## 6.2.15.4 Predefined keyboard layouts

To make the usage of the widget easier, some keyboard layout have already been defined for this widget. Refer to `KEYBOARD_SetLayout()` to learn how to set a layout to a KEYBOARD widget.

### Note

Some of the predefined layouts come in a simplified version and an advanced version with additional long press characters. The long press versions are marked with an `..._LP` suffix.

| Layout                          | Screenshot  | Description  |
|---------------------------------|---|--|
| KEYBOARD_ARA                    |  | Layout used for Arabic.                                  |
| KEYBOARD_DEU<br>KEYBOARD_DEU_LP |  | QWERTZ layout, used for German.                          |
| KEYBOARD_ENG<br>KEYBOARD_ENG_LP |  | QWERTY layout, used for the English language.            |
| KEYBOARD_FRA_LP                 |  | AZERTY layout, main layout used for the French language. |

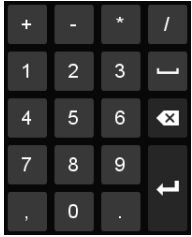
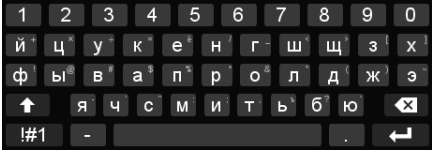
| Layout          | Screenshot  | Description   |
|-----------------|---|---|
| KEYBOARD_NUMPAD |  | Numpad layout.  |
| KEYBOARD_RUS    |  | ЙЦУКЕН/ЙЦУКЕН layout, main Cyrillic keyboard layout for the Russian language. |

### 6.2.15.5 Structure and definition of the widget

A KEYBOARD widget consists of a number of keys. Most keys (letters and numbers) are added to the keyboard via the definition of a key line. Keys can also be added individually and their appearance can be defined via text or using a bitmap.

The code of the predefined keyboard layouts can be taken as reference if a custom layout is desired.

#### 6.2.15.5.1 Key lines

Lines of keys can be defined and added to a keyboard, for example a line of characters would be QWERTYUIOP. With key lines, each key does not have to be added individually. Nor does each key have to be positioned and sized individually. The size and position of each key is calculated from the position and size of a key line.

A key line can be defined using the KEYDEF\_LINE structure.

#### Fixed key lines

Fixed key lines are key lines that remain unchanged when the shift key or the switch key is pressed. An example for this in the QWERTY layout would be the first line that contains the numbers 0 to 9.

| Key lines   | Fixed key line   |
|---|--|
|  |  |

#### 6.2.15.5.2 Keys

##### Shift key

A shift key is used to change between lower case key lines and upper case key lines.



A shift key is defined using the `KEYDEF_SHIFT` structure. The key has four states: normal (default), shift (one press), shift locked (two presses) and an extra state (three presses). The appearance of the states can be defined by passing an array of `KEYDEF_BUTTON` structures. Each `KEYDEF_BUTTON` element points to a bitmap. Alternatively, text can be added in order for it to be displayed on the key.

```
static const KEYDEF_SHIFT _KeyShift = { { 0, 600, 120, 200 },
    { NULL, &_acShift0_16x16, sizeof(_acShift0_16x16) },
    { NULL, &_acShift0_16x16, sizeof(_acShift1_16x16) },
    { NULL, &_acShift0_16x16, sizeof(_acShift0_16x16) },
    { NULL, NULL, 0 } };
```

## Switch key

A switch key is used to change between lower/upper case key lines and extra key lines. Extra key lines are intended to be used for special characters.

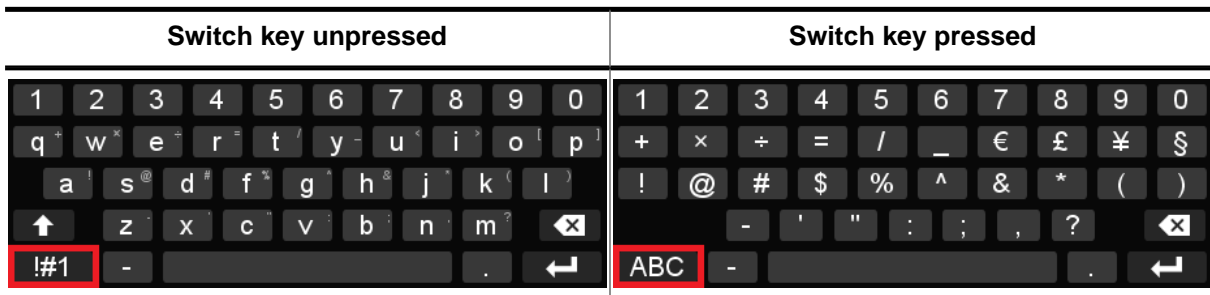

A switch key is defined using the `KEYDEF_SWITCH` structure. The key has two states: normal (default) and switched (one press). Just like for the shift key, the appearance of each state can be defined by passing an array of `KEYDEF_BUTTON` structures. Each element can either point to a bitmap or a string.

```
static const KEYDEF_SWITCH _KeySwitch = { { 0, 800, 150, 200 }, { { "!#1", NULL, 0 },
    { "ABC", NULL, 0 } } };
```

## Other keys

Any other keys that are not a part of a key line are added to the keyboard using the `KEYDEF_KEY` structure. The position and size must be specified first using the `KEYDEF_AREA` structure. Then the character code that the key should print is specified. The last structure member is of the type `KEYDEF_BUTTON` to define the appearance of the key.

```
static const KEYDEF_KEY _KeyBackspace = { { 880, 600, 120, 200 }, // Position and size of
    // key in promille
    0x0008, // Code (for KEYDEF_KEY only)
    { NULL, // Text
      &_acBackspace_24x16, // Pointer to streamed bitmap
    // or bitmap structure
    sizeof(_acBackspace_24x16) // Size of streamed bitmap
    } };
```

### 6.2.15.5.3 Long press characters

When an additional character or multiple additional characters have been set for a key, they can be accessed by performing a long press. This behavior is very much alike to the one of a smartphone keyboard.

The first character in the list of long press characters will be shown in small in the upper right corner of the key. If multiple long press characters are set, a dialog will open. The dialog shows all available long press characters. The user is able to select a character by holding the press and moving to the left or to the right.

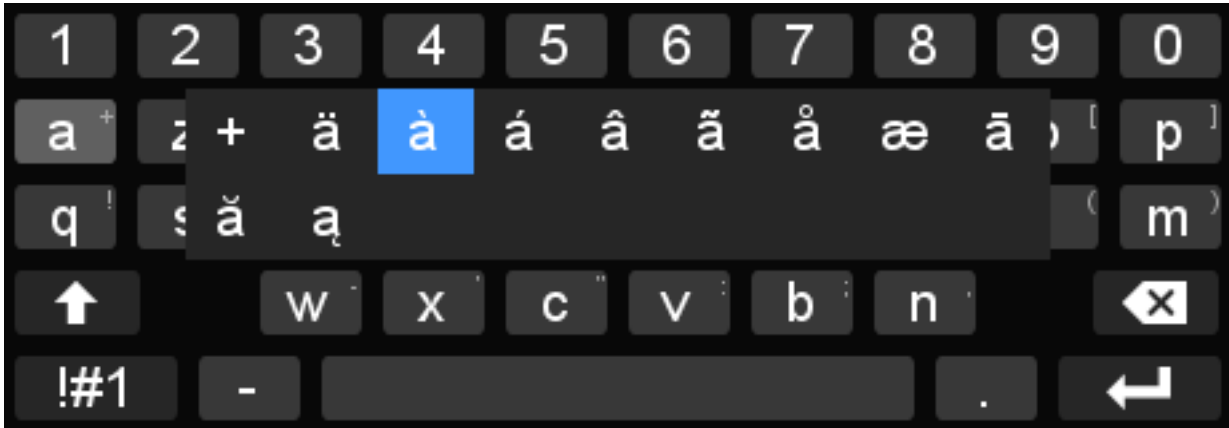

### 6.2.15.6 Import and export of layouts

The KEYBOARD widget also offers the possibility to export and import layouts. The layouts are saved as a .skbd file and have to be stored in accessible memory (RAM or ROM).

#### Import of layouts

Layouts can be imported using the routine `KEYBOARD_SetStreamedLayout()`. The API description also offers an example implementation using the Windows API.

#### Export of layouts

Layouts can be exported using the routine `KEYBOARD_ExportLayout()`. The API description also offers an example implementation using the Windows API.

## 6.2.15.7 KEYBOARD API

The table below lists the available emWin KEYBOARD-related routines in alphabetical order. Detailed descriptions of the routines follow.

### Functions

| Routine                                      | Description  |
|--|--|
| <a href="#">KEYBOARD_CreateUser()</a>        | Creates a new KEYBOARD widget.   |
| <a href="#">KEYBOARD_CreateIndirect()</a>    | Creates a KEYBOARD widget from a resource table entry.                   |
| <a href="#">KEYBOARD_ExportLayout()</a>      | Exports a KEYBOARD layout to an .skbd file.                              |
| <a href="#">KEYBOARD_ExportPatternFile()</a> | Exports a font pattern file for a given KEYBOARD layout.                 |
| <a href="#">KEYBOARD_SetLayout()</a>         | Sets a layout to a KEYBOARD widget.                                      |
| <a href="#">KEYBOARD_SetStreamedLayout()</a> | Sets a streamed layout from an external .skbd file to a KEYBOARD widget. |
| <a href="#">KEYBOARD_SetColor()</a>          | Sets the color of a KEYBOARD widget.                                     |
| <a href="#">KEYBOARD_SetFont()</a>           | Sets a font to the KEYBOARD widget.                                      |
| <a href="#">KEYBOARD_SetPeriod()</a>         | Sets the period of a KEYBOARD widget.                                    |
| <a href="#">KEYBOARD_SetRadius()</a>         | Sets the radius of the keys of a KEYBOARD widget.                        |
| <a href="#">KEYBOARD_SetSpace()</a>          | Sets the space between the keys of a KEYBOARD widget.                    |

### Data structures

| Structure                       | Description   |
|---------------------------------|---|
| <a href="#">KEYDEF_KEYBOARD</a> | Configuration structure to define the entire layout of a KEYBOARD widget.       |
| <a href="#">KEYBOARD_CODES</a>  | Structure that is used for storing pointers to arrays of long press characters. |
| <a href="#">KEYDEF_AREA</a>     | This structure is used to define the position and size of keys on the keyboard. |
| <a href="#">KEYDEF_KEY</a>      | Structure that defines a single key to be used in a keyboard.                   |
| <a href="#">KEYDEF_SHIFT</a>    | Configuration structure to define a shift key for the keyboard.                 |
| <a href="#">KEYDEF_SWITCH</a>   | Configuration structure to define a switch key for the keyboard.                |
| <a href="#">KEYDEF_BUTTON</a>   | Structure that holds information about how a key should look like.              |
| <a href="#">KEYDEF_LINE</a>     | Structure that defines one line of characters of a keyboard.                    |

### Defines

| Group of defines                        | Description                               |
|---|---|
| <a href="#">KEYBOARD color indexes</a>  | Color indexes used for KEYBOARD widgets.  |
| <a href="#">KEYBOARD font indexes</a>   | Font indexes used for KEYBOARD widgets.   |
| <a href="#">KEYBOARD period indexes</a> | Period indexes used for KEYBOARD widgets. |

## 6.2.15.7.1 Functions

### 6.2.15.7.1.1 KEYBOARD\_CreateUser()

#### Description

Creates a new KEYBOARD widget.

#### Prototype

```
KEYBOARD_Handle KEYBOARD_CreateUser(
    int          x0,
    int          y0,
    int          xSize,
    int          ySize,
    WM_HWIN     hParent,
    int         WinFlags,
    int         ExFlags,
    const KEYDEF_KEYBOARD * pKeyboard,
    int         Id,
    int         NumExtraBytes);
```

#### Parameters

| Parameter                  | Description  |
|----------------------------|--|
| <code>x0</code>            | Leftmost pixel of the KEYBOARD (in parent coordinates).  |
| <code>y0</code>            | Topmost pixel of the KEYBOARD (in parent coordinates).   |
| <code>xSize</code>         | Horizontal size of the KEYBOARD (in pixels).   |
| <code>ySize</code>         | Vertical size of the KEYBOARD (in pixels).   |
| <code>hParent</code>       | Handle of parent window.   |
| <code>WinFlags</code>      | Window create flags. Typically <code>WM_CF_SHOW</code> in order to make the widget visible immediately (refer to <i>Window create flags</i> on page 977 for a list of available parameter values). |
| <code>ExFlags</code>       | Not used yet, reserved for future use.   |
| <code>pKeyboard</code>     | Pointer to a data structure of type <code>KEYDEF_KEYBOARD</code> which defines the desired layout. Can be zero.  |
| <code>Id</code>            | Window ID of the widget.   |
| <code>NumExtraBytes</code> | Number of extra bytes to be allocated for user data.   |

#### Return value

Handle of the created KEYBOARD widget.

### 6.2.15.7.1.2 KEYBOARD\_CreateIndirect()

#### Description

The prototype of this function is explained at the beginning of this chapter. Details can be found in the description of the function `<WIDGET>_CreateIndirect()` on page . The elements `Flags` and `Para` of the resource passed as parameter are not used.



### 6.2.15.7.1.3 KEYBOARD\_ExportLayout()

#### Description

Exports a KEYBOARD layout to an .skbd file. The exported layout can be stored on external memory and imported using `KEYBOARD_SetStreamedLayout()`.

#### Prototype

```
void KEYBOARD_ExportLayout(      GUI_CALLBACK_VOID_U8_P * pfSerialize,
                                void * pVoid,
                                const KEYDEF_KEYBOARD * pKeyboard);
```

#### Parameters

| Parameter                | Description  |
|--------------------------|--|
| <code>pfSerialize</code> | Pointer to serialization callback function.  |
| <code>pVoid</code>       | Pointer to file handle.  |
| <code>pKeyboard</code>   | Pointer to a data structure of type <code>KEYDEF_KEYBOARD</code> containing the layout to be exported. |

#### Example

Below is a sample implementation that uses the Windows API functions.

```

/*****
 *
 *     _WriteByte2File
 */
static void _WriteByte2File(U8 Data, void * p) {
    HANDLE hFile;
    DWORD  NumBytesWritten;

    hFile = (HANDLE)p;
    WriteFile(hFile, &Data, 1, &NumBytesWritten, NULL);
}

/*****
 *
 *     _StreamLayout
 */
static void _StreamLayout() {
    HANDLE hFile;

    hFile = CreateFile("C:\\Temp\\
\\Layout.skbd", GENERIC_WRITE, 0, 0, CREATE_ALWAYS, FILE_ATTRIBUTE_NORMAL, 0);
    KEYBOARD_ExportLayout(_WriteByte2File, (void *)hFile, &KEYBOARD_ENG);
    CloseHandle(hFile);
}

```

### 6.2.15.7.1.4 KEYBOARD\_ExportPatternFile()

#### Description

Exports a font pattern file for a given KEYBOARD layout. This pattern file can be used when creating a font with the FontConverter for activating all required characters for the layout.

#### Prototype

```
void KEYBOARD_ExportPatternFile(      GUI_CALLBACK_VOID_U8_P * pfSerialize,
                                     void * pVoid,
                                     const KEYDEF_KEYBOARD * pKeyboard);
```

#### Parameters

| Parameter                | Description  |
|--------------------------|--|
| <code>pfSerialize</code> | Pointer to serialization callback function.                                  |
| <code>pVoid</code>       | Pointer to file handle.  |
| <code>pKeyboard</code>   | Pointer to a data structure of type <code>KEYDEF_KEYBOARD</code> to be used. |

#### Additional information

Information on how to use pattern files with the FontConverter tool can be read under *Pattern files* on page 2847.

### 6.2.15.7.1.5 KEYBOARD\_SetLayout()

#### Description

Sets a layout to a KEYBOARD widget.

#### Prototype

```
int KEYBOARD_SetLayout(      KEYBOARD_Handle  hObj,  
                           const KEYDEF_KEYBOARD * pKeyboard);
```

#### Parameters

| Parameter              | Description  |
|------------------------|--|
| <code>hObj</code>      | Handle to KEYBOARD widget.   |
| <code>pKeyboard</code> | Pointer to a data structure of type <code>KEYDEF_KEYBOARD</code> . |

#### Return value

0        On success.  
1        On error.

#### Additional information

A list of predefined layouts can be found under *Predefined keyboard layouts* on page 1486.

#### Example

```
KEYBOARD_SetLayout(hKeyboard, &KEYBOARD_ENG);
```

### 6.2.15.7.1.6 KEYBOARD\_SetStreamedLayout()

#### Description

Sets a streamed layout from an external .skbd file to a KEYBOARD widget.

#### Prototype

```
int KEYBOARD_SetStreamedLayout(    KEYBOARD_Handle  hObj,
                                   const void          * pVoid,
                                   U32                  Size);
```

#### Parameters

| Parameter          | Description  |
|--------------------|--|
| <code>hObj</code>  | Handle to KEYBOARD widget.   |
| <code>pVoid</code> | Pointer to streamed data. The data has to remain valid after the function has been called. |
| <code>Size</code>  | <code>Size</code> of streamed data in bytes.   |

#### Return value

0        On success.  
1        On error.

#### Example

Below is a sample implementation that uses the Windows API functions.

```
static void _LoadStreamedLayout(void) {
    HANDLE hFile;
    DWORD  FileSize;
    char * pData;
    DWORD  NumBytesRead;

    hFile    = CreateFile("C:\\Temp\\
\\Layout.skbd", GENERIC_READ, 0, 0, OPEN_EXISTING, FILE_ATTRIBUTE_NORMAL, 0);
    FileSize = GetFileSize(hFile, NULL);
    pData    = (char *)malloc(FileSize);
    ReadFile(hFile, pData, FileSize, &NumBytesRead, NULL);
    CloseHandle(hFile);
    KEYBOARD_SetStreamedLayout(hKeyboard, pData, NumBytesRead);
}
```

Alternatively, the .skbd file can also be converted into an array (using the Bin2C tool) and stored in accessible memory.

```
KEYBOARD_SetStreamedLayout(hKeyboard, _acLayout, sizeof(_acLayout));
```

### 6.2.15.7.1.7 KEYBOARD\_SetColor()

#### Description

Sets the color of a KEYBOARD widget.

#### Prototype

```
void KEYBOARD_SetColor(KEYBOARD_Handle hObj,  
                        unsigned Index,  
                        GUI_COLOR Color);
```

#### Parameters

| Parameter             | Description   |
|-----------------------|---|
| <a href="#">hObj</a>  | Handle to KEYBOARD widget.  |
| <a href="#">Index</a> | <a href="#">Color</a> index. Refer to <i>KEYBOARD color indexes</i> on page 1511. |
| <a href="#">Color</a> | <a href="#">Color</a> to use for specified index.                                 |

### 6.2.15.7.1.8 KEYBOARD\_SetFont()

#### Description

Sets a font to the KEYBOARD widget.

#### Prototype

```
void KEYBOARD_SetFont(      KEYBOARD_Handle  hObj,  
                           unsigned          Index,  
                           const GUI_FONT    * pFont );
```

#### Parameters

| Parameter             | Description   |
|-----------------------|---|
| <a href="#">hObj</a>  | Handle to KEYBOARD widget.                                      |
| <a href="#">Index</a> | Font index. Refer to <i>KEYBOARD font indexes</i> on page 1512. |
| <a href="#">pFont</a> | Font to be used.  |

### 6.2.15.7.1.9 KEYBOARD\_SetPeriod()

#### Description

Sets the period of a KEYBOARD widget. The period can be for long pressing a key or holding a key (such as backspace), depending on the period index.

#### Prototype

```
void KEYBOARD_SetPeriod(KEYBOARD_Handle hObj,  
                        unsigned Index,  
                        unsigned Period);
```

#### Parameters

| Parameter              | Description   |
|------------------------|---|
| <a href="#">hObj</a>   | Handle to KEYBOARD widget.  |
| <a href="#">Index</a>  | <a href="#">Period</a> index. Refer to <i>KEYBOARD period indexes</i> on page 1513. |
| <a href="#">Period</a> | New period to use.  |

### 6.2.15.7.1.10 KEYBOARD\_SetRadius()

#### Description

Sets the radius of the keys of a KEYBOARD widget.

#### Prototype

```
void KEYBOARD_SetRadius(KEYBOARD_Handle hObj,  
                        unsigned Radius);
```

#### Parameters

| Parameter              | Description                |
|------------------------|----------------------------|
| <a href="#">hObj</a>   | Handle to KEYBOARD widget. |
| <a href="#">Radius</a> | New radius to be used.     |



### 6.2.15.7.1.11 KEYBOARD\_SetSpace()

#### Description

Sets the space between the keys of a KEYBOARD widget.

#### Prototype

```
void KEYBOARD_SetSpace(KEYBOARD_Handle hObj,  
                        unsigned        Axis,  
                        unsigned        Space);
```

#### Parameters

| Parameter             | Description                |
|-----------------------|----------------------------|
| <a href="#">hObj</a>  | Handle to KEYBOARD widget. |
| <a href="#">Index</a> | Axis to be set.            |
| <a href="#">Space</a> | New space to be used used. |

## 6.2.15.7.2 Data structures

### 6.2.15.7.2.1 KEYDEF\_KEYBOARD

#### Description

Configuration structure to define the entire layout of a KEYBOARD widget. A pointer to a filled structure of this type can be passed to `KEYBOARD_SetLayout()` or `KEYBOARD_CreateUser()`.

If any keyboard components are not needed for the layout, such as certain keys or shift lines etc., `NULL` can be passed instead.

#### Type definition

```
typedef struct {
    const char          * pLongName;
    const KEYDEF_KEY    * pDefBackspace;
    const KEYDEF_KEY    * pDefEnter;
    const KEYDEF_KEY    * pDefSpace;
    const KEYDEF_SHIFT  * pDefShift;
    const KEYDEF_SWITCH * pDefSwitch;
    unsigned            NumFixedLines;
    unsigned            NumCodesLines;
    unsigned            NumShiftLines;
    unsigned            NumExtraLines;
    const KEYDEF_LINE   ** ppLineFixed;
    const KEYDEF_LINE   ** ppLineCodes;
    const KEYDEF_LINE   ** ppLineShift;
    const KEYDEF_LINE   ** ppLineExtra;
    unsigned            wLong;
    unsigned            hLong;
} KEYDEF_KEYBOARD;
```

#### Structure members

| Member                     | Description  |
|----------------------------|--|
| <code>pLongName</code>     | Name of the layout. The name is only used by AppWizard, therefore the pointer can be <code>NULL</code> .     |
| <code>pDefBackspace</code> | Pointer to key definition of backspace key.  |
| <code>pDefEnter</code>     | Pointer to key definition of enter key.  |
| <code>pDefSpace</code>     | Pointer to key definition of space key.  |
| <code>pDefShift</code>     | Pointer to the definition structure of the shift key.  |
| <code>pDefSwitch</code>    | Pointer to the definition structure of the switch key.   |
| <code>NumFixedLines</code> | Number of fixed lines of characters in the keyboard that will not be affected by the shift or switch key.    |
| <code>NumCodesLines</code> | Number of lines of characters in the keyboard that are shown when neither shift nor switch has been pressed. |
| <code>NumShiftLines</code> | Number of lines of characters to be shown when the shift key has been pressed.                               |
| <code>NumExtraLines</code> | Number of lines of characters to be shown when the switch key has been pressed.                              |
| <code>ppLineFixed</code>   | Pointer to an array of definition structures for the fixed lines of characters.                              |
| <code>ppLineCodes</code>   | Pointer to an array of definition structures for the lines shown by default.                                 |
| <code>ppLineShift</code>   | Pointer to an array of definition structures for the lines shown when the shift key is pressed.              |

| Member                   | Description  |
|--------------------------|--|
| <code>ppLineExtra</code> | Pointer to an array of definition structures for the lines shown when the switch key is pressed.                                   |
| <code>wLong</code>       | Width of a long press key in the long press dialog. The size is specified in promille and relative to the KEYBOARD widget's size.  |
| <code>hLong</code>       | Height of a long press key in the long press dialog. The size is specified in promille and relative to the KEYBOARD widget's size. |

## Example

```

const KEYDEF_KEYBOARD_KEYBOARD_ENG = {
    //
    // Long name
    //
    _acLongName,
    //
    // Special keys...
    //
    &_KeyBackspace,
    &_KeyEnter,
    &_KeySpace,
    &_KeyShift,
    &_KeySwitch,
    //
    // Numbers of key lines...
    //
    GUI_COUNTOF(_apLineFixed),
    GUI_COUNTOF(_apLineCodes),
    GUI_COUNTOF(_apLineShift),
    GUI_COUNTOF(_apLineExtra),
    //
    // Pointers to key lines...
    //
    _apLineFixed,
    _apLineCodes,
    _apLineShift,
    _apLineExtra,
    //
    // Size of longpress key
    //
    80, // Width in promille of keyboard's x-size
    200, // Height in promille of keyboard's y-size
};

```

### 6.2.15.7.2.2 KEYBOARD\_CODES

#### Description

Structure that is used for storing pointers to arrays of long press characters.

#### Type definition

```
typedef struct {
    unsigned    NumCodes;
    const U16 * pCodes;
} KEYBOARD_CODES;
```

#### Structure members

| Member                | Description                             |
|-----------------------|---|
| <code>NumCodes</code> | Number of characters.                   |
| <code>pCodes</code>   | Pointer to an array of character codes. |

#### Example

```
static const U16 _aLong21_00[] = { 0x002d, 0x0179, 0x017b, 0x017d };
static const U16 _aLong21_01[] = { 0x0027 };
static const U16 _aLong21_02[] = { 0x0022, 0x00c7, 0x0106, 0x010c };
static const KEYBOARD_CODES _aLong21[] = {
    { GUI_COUNTOF(_aLong21_00), _aLong21_00 },
    { GUI_COUNTOF(_aLong21_01), _aLong21_01 },
    { GUI_COUNTOF(_aLong21_02), _aLong21_02 },
};
```

The pointer to the array containing pointers to the long press arrays is then passed as last member of the `KEYDEF_LINE` structure.

```
static const KEYDEF_LINE _AlphaUpper2 = { { 150, 600, 700, 200 },
    { GUI_COUNTOF(_aAlphaUpper2), _aAlphaUpper2 },
    _aLong21 };
```

### 6.2.15.7.2.3 KEYDEF\_AREA

#### Description

This structure is used to define the position and size of keys on the keyboard.

#### Type definition

```
typedef struct {  
    unsigned x;  
    unsigned y;  
    unsigned w;  
    unsigned h;  
} KEYDEF_AREA;
```

#### Structure members

| Member         | Description |
|----------------|-------------|
| <code>x</code> | X-position. |
| <code>y</code> | Y-position. |
| <code>w</code> | Width.      |
| <code>h</code> | Height.     |

#### Additional information

All positions and sizes are entered in promille. This way, the sizes and positions are relative to the keyboard's window size.

For example, if the width of a key line is defined as 1000, that means the line will span over the entire keyboard widget, since 1000‰ equals 100%. If the keyboard widget has an `x`-size of 400 px, the line will also have an `x`-size of 400.

### 6.2.15.7.2.4 KEYDEF\_KEY

#### Description

Structure that defines a single key to be used in a keyboard.

#### Type definition

```
typedef struct {
    const KEYDEF_AREA    Area;
    U16                  Code;
    const KEYDEF_BUTTON  Button;
} KEYDEF_KEY;
```

#### Structure members

| Member                 | Description   |
|------------------------|---|
| <a href="#">Area</a>   | Pointer to data structure of type <code>KEYDEF_AREA</code> that defines the position and size of the key. |
| <a href="#">Code</a>   | Character code that is inserted when the key is pressed.  |
| <a href="#">Button</a> | Pointer to data structure of type <code>KEYDEF_BUTTON</code> that defines the appearance of the key.      |

#### Example

```
static const KEYDEF_KEY _KeyBackspace = { { 880, 600, 120, 200 }, // Position and size of
                                           // key in promille
                                           0x0008, // Code (for KEYDEF_KEY only)
                                           { NULL, // Text
                                             &_acBackspace_24x16, // Pointer to streamed bitmap
                                             // or bitmap structure
                                             sizeof(_acBackspace_24x16) // Size of streamed bitmap
                                           } };
```

### 6.2.15.7.2.5 KEYDEF\_SHIFT

#### Description

Configuration structure to define a shift key for the keyboard. A shift key is used to switch between lower and upper case letters.

#### Type definition

```
typedef struct {
    const KEYDEF_AREA    Area;
    const KEYDEF_BUTTON  aButton[];
} KEYDEF_SHIFT;
```

#### Structure members

| Member               | Description  |
|----------------------|--|
| <code>Area</code>    | Data structure of type <code>KEYDEF_AREA</code> that defines position and size of the shift key.   |
| <code>aButton</code> | Array of type <code>KEYDEF_BUTTON</code> that holds the definition of appearance of four states. The four states are: normal, shift, shift locked and extra. |

#### Example

```
static const KEYDEF_SHIFT _KeyShift = { { 0, 600, 120, 200 },
    { { NULL, &_acShift0_16x16, sizeof(_acShift0_16x16) },
      { NULL, &_acShift0_16x16, sizeof(_acShift1_16x16) },
      { NULL, &_acShift0_16x16, sizeof(_acShift0_16x16) },
      { NULL, NULL, 0 } } };
```

### 6.2.15.7.2.6 KEYDEF\_SWITCH

#### Description

Configuration structure to define a switch key for the keyboard. A switch key is used to switch between different lines of characters, mostly used for switching between letters and special characters.

#### Type definition

```
typedef struct {
    const KEYDEF_AREA    Area;
    const KEYDEF_BUTTON  aButton[];
} KEYDEF_SWITCH;
```

#### Structure members

| Member               | Description  |
|----------------------|--|
| <code>Area</code>    | Data structure of type <code>KEYDEF_AREA</code> that defines position and size of the switch key.              |
| <code>aButton</code> | Array of type <code>KEYDEF_BUTTON</code> that holds the appearance definition for pressed and unpressed state. |

#### Example

```
static const KEYDEF_SWITCH _KeySwitch = { { { 0, 800, 150, 200 },
                                             { { "#1", NULL, 0 },
                                               { "ABC", NULL, 0 } } } };
```



### 6.2.15.7.2.7 KEYDEF\_BUTTON

#### Description

Structure that holds information about how a key should look like. This structure is used by `KEYDEF_KEY`, `KEYDEF_SHIFT` and `KEYDEF_SWITCH`.

#### Type definition

```
typedef struct {
    const char * pText;
    const void * pBm;
    U32          Size;
} KEYDEF_BUTTON;
```

#### Structure members

| Member             | Description                                   |
|--------------------|---|
| <code>pText</code> | Pointer to text shown for the key.            |
| <code>pBm</code>   | Pointer to streamed bitmap shown for the key. |
| <code>Size</code>  | Array size of streamed bitmap.                |

#### Additional information

The streamed bitmap should ideally contain a compressed alpha channel (type: "Alpha channel, compressed"). This is necessary so the given shift color can be applied to the key bitmap.

#### Note

Either a text or a bitmap can be set for a key, this means either the pointer `pBm` or `pText` in this structure **must** be `NULL`.

### 6.2.15.7.2.8 KEYDEF\_LINE

#### Description

Structure that defines one line of characters of a keyboard.

#### Type definition

```
typedef struct {
    KEYDEF_AREA          Area;
    KEYBOARD_CODES      Codes;
    const KEYBOARD_CODES * pCodesLong;
} KEYDEF_LINE;
```

#### Structure members

| Member                     | Description   |
|----------------------------|---|
| <a href="#">Area</a>       | Data structure of type <code>KEYDEF_AREA</code> that defines position and size of the line.   |
| <a href="#">Codes</a>      | Data structure of type <code>KEYBOARD_CODES</code> that hold the character codes to be used for the line.   |
| <a href="#">pCodesLong</a> | Pointer to an array of the type <code>KEYBOARD_CODES</code> that holds the character codes for long press.<br><b>Note:</b> The number of elements in the array <b>must</b> be equal to the number of codes defined in the previous member <a href="#">Codes</a> . |

#### Additional information

The given key codes defined in [Codes](#) are spread equally and horizontally over the area defined in the member [Area](#).

#### Example

```
static const KEYDEF_LINE _AlphaUpper2 = { { 150, 600, 700, 200 },
                                           { GUI_COUNTOF(_aAlphaUpper2), _aAlphaUpper2 },
                                           _aLong21 };
```

### 6.2.15.7.3 Defines

#### 6.2.15.7.3.1 KEYBOARD color indexes

##### Description

Color indices for KEYBOARD widget.

##### Definition

```
#define KEYBOARD_CI_KEY           0
#define KEYBOARD_CI_FKEY         1
#define KEYBOARD_CI_PRESSED      2
#define KEYBOARD_CI_BK           5
#define KEYBOARD_CI_CODE         3
#define KEYBOARD_CI_LONG         4
#define KEYBOARD_CI_MARK         6
```

##### Symbols

| Definition                          | Description                                  |
|-------------------------------------|--|
| <a href="#">KEYBOARD_CI_KEY</a>     | Color of key.                                |
| <a href="#">KEYBOARD_CI_FKEY</a>    | Color of function key, such as shift.        |
| <a href="#">KEYBOARD_CI_PRESSED</a> | Pressed color of a key.                      |
| <a href="#">KEYBOARD_CI_BK</a>      | Background color of widget.                  |
| <a href="#">KEYBOARD_CI_CODE</a>    | Text color of character on a key.            |
| <a href="#">KEYBOARD_CI_LONG</a>    | Text color of long press character on a key. |
| <a href="#">KEYBOARD_CI_MARK</a>    | Color of shift-lock symbol.                  |

### 6.2.15.7.3.2 KEYBOARD font indexes

#### Description

Font indexes for KEYBOARD widget.

#### Definition

```
#define KEYBOARD_FI_CODE      0
#define KEYBOARD_FI_LONG     1
```

#### Symbols

| Definition                       | Description   |
|----------------------------------|---|
| <a href="#">KEYBOARD_FI_CODE</a> | Font used for text displayed on a key.                          |
| <a href="#">KEYBOARD_FI_LONG</a> | Font used for smaller long press characters displayed on a key. |

### 6.2.15.7.3.3 KEYBOARD period indexes

#### Description

Period indices for KEYBOARD widget.

#### Definition



```
#define KEYBOARD_PI_LONGPRESS    0
#define KEYBOARD_PI_REPEAT      1
```

#### Symbols

| Definition                            | Description   |
|---------------------------------------|---|
| <a href="#">KEYBOARD_PI_LONGPRESS</a> | Period it takes for a long press to open the long press dialog. |
| <a href="#">KEYBOARD_PI_REPEAT</a>    | Period for repeated actions, such as holding the backspace key. |

## 6.2.16 LISTBOX: List box widget

LISTBOX widgets are used to select one element of a list. A list box can be created without a surrounding frame window, as shown below, or as a child window of a FRAMEWIN widget (see the additional screenshots at the end of the section). As items in a list box are selected, they appear highlighted. Note that the background color of a selected item depends on whether the list box window has input focus.

| List box with focus   | List box without focus  |
|---|---|
|  |  |

### Note

All LISTBOX-related routines are in the file(s) LISTBOX\*.c, LISTBOX.h.  
All identifiers are prefixed LISTBOX.

### 6.2.16.1 Configuration options

| Type | Macro                      | Default       | Description                                     |
|------|----------------------------|---------------|---|
| N    | LISTBOX_BKCOLOR0_DEFAULT   | GUI_WHITE     | Background color, unselected state.             |
| N    | LISTBOX_BKCOLOR1_DEFAULT   | GUI_GRAY      | Background color, selected state without focus. |
| N    | LISTBOX_BKCOLOR2_DEFAULT   | GUI_BLUE      | Background color, selected state with focus.    |
| S    | LISTBOX_FONT_DEFAULT       | &GUI_Font13_1 | Font used.                                      |
| N    | LISTBOX_TEXTCOLOR0_DEFAULT | GUI_BLACK     | Text color, unselected state.                   |
| N    | LISTBOX_TEXTCOLOR1_DEFAULT | GUI_WHITE     | Text color, selected state without focus.       |
| N    | LISTBOX_TEXTCOLOR2_DEFAULT | GUI_WHITE     | Text color, selected state with focus.          |

### 6.2.16.2 Predefined IDs

The following symbols define IDs which may be used to make LISTBOX widgets distinguishable from creation.

```
#define GUI_ID_LISTBOX0    0x110
#define GUI_ID_LISTBOX1    0x111
#define GUI_ID_LISTBOX2    0x112
#define GUI_ID_LISTBOX3    0x113
#define GUI_ID_LISTBOX4    0x114
#define GUI_ID_LISTBOX5    0x115
#define GUI_ID_LISTBOX6    0x116
#define GUI_ID_LISTBOX7    0x117
#define GUI_ID_LISTBOX8    0x118
#define GUI_ID_LISTBOX9    0x119
```

### 6.2.16.3 Notification codes

The following events are sent from a LISTBOX widget to its parent window as part of a WM\_NOTIFY\_PARENT message:

| Message                  | Description                |
|--------------------------|----------------------------|
| WM_NOTIFICATION_CLICKED  | LISTBOX has been clicked.  |
| WM_NOTIFICATION_RELEASED | LISTBOX has been released. |

| Message                        | Description   |
|--------------------------------|---|
| WM_NOTIFICATION_MOVED_OUT      | LISTBOX has been clicked and pointer has been moved out of the box without releasing. |
| WM_NOTIFICATION_SCROLL_CHANGED | The scroll position of the optional scroll bar has been changed.                      |
| WM_NOTIFICATION_SEL_CHANGED    | The selection of the LISTBOX widget has changed.                                      |

## 6.2.16.4 Keyboard reaction

The widget reacts to the following keys if it has the input focus:

| Key           | Reaction   |
|---------------|--|
| GUI_KEY_SPACE | If the widget works in multi selection mode this key toggles the state of the current selected item.                               |
| GUI_KEY_RIGHT | If the maximum X-size of the list box items is larger than the list box itself this key scrolls the list box content to the left.  |
| GUI_KEY_LEFT  | If the maximum X-size of the list box items is larger than the list box itself this key scrolls the list box content to the right. |
| GUI_KEY_DOWN  | Moves the selection bar down.  |
| GUI_KEY_UP    | Moves the selection bar up.  |

## 6.2.16.5 LISTBOX API

The table below lists the available emWin LISTBOX-related routines in alphabetical order. Detailed descriptions of the routines follow.

### Functions

| Routine   | Description   |
|---|---|
| <a href="#">LISTBOX_AddString()</a>             | Adds an item to a LISTBOX widget.   |
| <a href="#">LISTBOX_Create()</a>                | Creates a LISTBOX widget. (Obsolete)  |
| <a href="#">LISTBOX_CreateAsChild()</a>         | Creates a LISTBOX widget as a child window. (Obsolete)                        |
| <a href="#">LISTBOX_CreateEx()</a>              | Creates a LISTBOX widget.   |
| <a href="#">LISTBOX_CreateIndirect()</a>        | Creates a LISTBOX widget from resource table entry.                           |
| <a href="#">LISTBOX_CreateUser()</a>            | Creates a LISTBOX widget using extra bytes as user data.                      |
| <a href="#">LISTBOX_DecSel()</a>                | Decrements selection.   |
| <a href="#">LISTBOX_DeleteItem()</a>            | Deletes an element.   |
| <a href="#">LISTBOX_EnableMotion()</a>          | Enables motion support for the given LISTBOX widget.                          |
| <a href="#">LISTBOX_EnableWrapMode()</a>        | Enables scrolling from the end to the beginning and vice versa.               |
| <a href="#">LISTBOX_GetBkColor()</a>            | Returns the background color of the widget.                                   |
| <a href="#">LISTBOX_GetDefaultBkColor()</a>     | Returns the default background color for new LISTBOX widgets.                 |
| <a href="#">LISTBOX_GetDefaultFont()</a>        | Returns the default font used for creating LISTBOX widgets.                   |
| <a href="#">LISTBOX_GetDefaultScrollStepH()</a> | Returns the default horizontal scroll step used for creating LISTBOX widgets. |

| Routine                                       | Description   |
|---|---|
| <code>LISTBOX_GetDefaultTextAlign()</code>    | Returns the default text alignment for new LISTBOX widgets.   |
| <code>LISTBOX_GetDefaultTextColor()</code>    | Returns the default text color for new LISTBOX widgets.   |
| <code>LISTBOX_GetFont()</code>                | Returns a pointer to the font used to display the text of the LISTBOX widget.   |
| <code>LISTBOX_GetItemDisabled()</code>        | Returns if the given item of the LISTBOX widget has been disabled.  |
| <code>LISTBOX_GetItemSel()</code>             | Returns the selection state of the given LISTBOX item.  |
| <code>LISTBOX_GetItemSpacing()</code>         | This function returns the distance between the different items of a LISTBOX.  |
| <code>LISTBOX_GetItemText()</code>            | Returns the text of the given item of the LISTBOX widget.   |
| <code>LISTBOX_GetMulti()</code>               | Returns if the multi selection mode of the given LISTBOX widget is active.  |
| <code>LISTBOX_GetNumItems()</code>            | Returns the number of items in a specified LISTBOX widget.  |
| <code>LISTBOX_GetOwner()</code>               | Returns the 'owner' of the widget.  |
| <code>LISTBOX_GetScrollStepH()</code>         | Returns the horizontal scroll step of the given LISTBOX widget.   |
| <code>LISTBOX_GetSel()</code>                 | Returns the zero based index of the currently selected item in a specified LISTBOX widget.                              |
| <code>LISTBOX_GetTextAlign()</code>           | Returns the text alignment of the given LISTBOX widget.   |
| <code>LISTBOX_GetTextColor()</code>           | Returns the text color of the widget.   |
| <code>LISTBOX_GetUserData()</code>            | Retrieves the data set with <code>LISTBOX_SetUserData()</code> .  |
| <code>LISTBOX_GetVisItemIndices()</code>      | Retrieves the index of the first and last visible item.   |
| <code>LISTBOX_IncSel()</code>                 | Increment the selection of the LISTBOX widget (moves the selection bar of a specified LISTBOX widget down by one item). |
| <code>LISTBOX_InsertString()</code>           | Inserts an element into a LISTBOX widget.   |
| <code>LISTBOX_InvalidItem()</code>            | Invalidates an item of a owner drawn LISTBOX widget.  |
| <code>LISTBOX_IsItemPartiallyVisible()</code> | Returns if an item of the LISTBOX is partially visible, fully visible or not visible at all.                            |
| <code>LISTBOX_OwnerDraw()</code>              | Default function to handle a LISTBOX entry.   |
| <code>LISTBOX_SetAutoScrollH()</code>         | Enables/disables the automatic use of a horizontal scroll bar.  |
| <code>LISTBOX_SetAutoScrollV()</code>         | Enables/disables the automatic use of a vertical scroll bar.  |
| <code>LISTBOX_SetBkColor()</code>             | Sets the background color of the LISTBOX widget.  |
| <code>LISTBOX_SetDefaultBkColor()</code>      | Sets the default background color for new LISTBOX widgets.  |
| <code>LISTBOX_SetDefaultFont()</code>         | Sets the default font used for creating LISTBOX widgets.  |



| Routine                                      | Description   |
|--|---|
| <code>LISTBOX_SetDefaultScrollStepH()</code> | Sets the default horizontal scroll step used when creating a LISTBOX widget.          |
| <code>LISTBOX_SetDefaultTextAlign()</code>   | Sets the default text alignment for new LISTBOX widgets.                              |
| <code>LISTBOX_SetDefaultTextColor()</code>   | Sets the default text color for new LISTBOX widgets.                                  |
| <code>LISTBOX_SetFixedScrollPos()</code>     | Enables the fixed scroll mode for the given LISTBOX widget.                           |
| <code>LISTBOX_SetFont()</code>               | Sets the font of the LISTBOX widget.  |
| <code>LISTBOX_SetItemDisabled()</code>       | Modifies the disable state of the given list item of the LISTBOX widget.              |
| <code>LISTBOX_SetItemSel()</code>            | Modifies the selection state of the given item of the LISTBOX widget.                 |
| <code>LISTBOX_SetItemSpacing()</code>        | Sets an additional spacing below the items of a LISTBOX widget.                       |
| <code>LISTBOX_SetMulti()</code>              | Switches the multi selection mode of a LISTBOX on or off.                             |
| <code>LISTBOX_SetOwnerDraw()</code>          | Sets the LISTBOX widget to be owner drawn.  |
| <code>LISTBOX_SetScrollbarColor()</code>     | Sets the colors of the optional scroll bar.   |
| <code>LISTBOX_SetScrollbarWidth()</code>     | Sets the width of the scroll bars used by the given LISTBOX widget.                   |
| <code>LISTBOX_SetScrollStepH()</code>        | Sets the horizontal scroll step of the given LISTBOX widget.                          |
| <code>LISTBOX_SetSel()</code>                | Sets the selected item of a specified LISTBOX widget.                                 |
| <code>LISTBOX_SetString()</code>             | Sets the content of the given item.   |
| <code>LISTBOX_SetTextAlign()</code>          | The function sets the text alignment used to display each item of the LISTBOX widget. |
| <code>LISTBOX_SetTextColor()</code>          | Sets the text color of the LISTBOX widget.  |
| <code>LISTBOX_SetUserData()</code>           | Sets the extra data of a LISTBOX widget.  |

## Defines

| Group of defines                             | Description   |
|--|---|
| <code>LISTBOX_color_indexes</code>           | Color indexes used by the LISTBOX widget.             |
| <code>LISTBOX_fixed_scroll_mode_flags</code> | Defines used for the fixed scroll mode of the widget. |

## 6.2.16.5.1 Functions

### 6.2.16.5.1.1 LISTBOX\_AddString()

#### Description

Adds an item to an already existing LISTBOX widget.

#### Prototype

```
void LISTBOX_AddString(      LISTBOX_Handle  hObj,  
                           const char      * s);
```

#### Parameters

| Parameter         | Description               |
|-------------------|---------------------------|
| <code>hObj</code> | Handle of LISTBOX widget. |
| <code>s</code>    | Text to display.          |

### 6.2.16.5.1.2 LISTBOX\_Create()

#### Note

This function is **deprecated**, `LISTBOX_CreateEx()` should be used instead.

#### Description

Creates a LISTBOX widget of a specified size at a specified location.

#### Prototype

```
LISTBOX_Handle LISTBOX_Create(const GUI_ConstString * ppText,
                             int x0,
                             int y0,
                             int xSize,
                             int ySize,
                             int Flags);
```

#### Parameters

| Parameter           | Description  |
|---------------------|--|
| <code>ppText</code> | Pointer to an array of string pointers containing the elements to be displayed.  |
| <code>x0</code>     | Leftmost pixel of the LISTBOX widget (in parent coordinates).  |
| <code>y0</code>     | Topmost pixel of the LISTBOX widget (in parent coordinates).   |
| <code>xSize</code>  | Horizontal size of the LISTBOX widget (in pixels).   |
| <code>ySize</code>  | Vertical size of the LISTBOX widget (in pixels).   |
| <code>Flags</code>  | Window create flags. Typically <code>WM_CF_SHOW</code> in order to make the widget visible immediately (refer to <i>Window create flags</i> on page 977 for a list of available parameter values). |

#### Return value

Handle of the created LISTBOX widget; 0 if the function fails.

#### Additional information

If the parameter `ySize` is greater than the required space for drawing the content of the widget, the y-size will be reduced to the required value. The same applies to the `xSize` parameter.

### 6.2.16.5.1.3 LISTBOX\_CreateAsChild()

#### Note

This function is **deprecated**, `LISTBOX_CreateEx()` should be used instead.

#### Description

Creates a LISTBOX widget as a child window.

#### Prototype

```
LISTBOX_Handle LISTBOX_CreateAsChild(const GUI_ConstString * ppText,
                                     WM_HWIN          hWinParent,
                                     int                x0,
                                     int                y0,
                                     int                xSize,
                                     int                ySize,
                                     int                Flags);
```

#### Parameters

| Parameter            | Description   |
|----------------------|---|
| <code>ppText</code>  | Pointer to an array of string pointers containing the elements to be displayed. |
| <code>hParent</code> | Handle of parent window.  |
| <code>x0</code>      | X-position of the LISTBOX widget relative to the parent window.                 |
| <code>y0</code>      | Y-position of the LISTBOX widget relative to the parent window.                 |
| <code>xSize</code>   | Horizontal size of the LISTBOX widget (in pixels).                              |
| <code>ySize</code>   | Vertical size of the LISTBOX widget (in pixels).                                |
| <code>Flags</code>   | Window create flags (see <i>Window create flags</i> on page 977).               |

#### Return value

Handle of the created LISTBOX widget; 0 if the function fails.

#### Additional information

If the parameter `ySize` is greater than the space required for drawing the content of the widget, the Y-size will be reduced to the required value. If `ySize` = 0 the Y-size of the widget will be set to the Y-size of the client area from the parent window. The same applies for the `xSize` parameter.

### 6.2.16.5.1.4 LISTBOX\_CreateEx()

#### Description

Creates a LISTBOX widget of a specified size at a specified location.

#### Prototype

```
LISTBOX_Handle LISTBOX_CreateEx(    int        x0,
                                   int        y0,
                                   int        xSize,
                                   int        ySize,
                                   WM_HWIN    hParent,
                                   int        WinFlags,
                                   int        ExFlags,
                                   int        Id,
                                   const GUI_ConstString * ppText);
```

#### Parameters

| Parameter             | Description  |
|-----------------------|--|
| <code>x0</code>       | Leftmost pixel of the widget (in parent coordinates).  |
| <code>y0</code>       | Topmost pixel of the widget (in parent coordinates).   |
| <code>xSize</code>    | Horizontal size of the widget (in pixels).   |
| <code>ySize</code>    | Vertical size of the widget (in pixels).   |
| <code>hParent</code>  | Handle of parent window. If 0, the new HEADER widget will be a child of the desktop (top-level window).  |
| <code>WinFlags</code> | Window create flags. Typically <code>WM_CF_SHOW</code> in order to make the widget visible immediately (refer to <i>Window create flags</i> on page 977 for a list of available parameter values). |
| <code>ExFlags</code>  | Not used, reserved for future use.   |
| <code>Id</code>       | Window ID of the widget.   |
| <code>ppText</code>   | Pointer to an array of string pointers containing the elements to be displayed. The last entry of this array has to be <code>NULL</code> .   |

#### Return value

Handle of the created LISTBOX widget; 0 if the function fails.

#### Additional information

If an array of string pointers is set as last parameter, please make sure that the last entry in this array is `NULL`.

### 6.2.16.5.1.5 LISTBOX\_CreateIndirect()

#### Description

The prototype of this function is explained at the beginning of this chapter. Details can be found in the description of the function `<WIDGET>_CreateIndirect()` on page 992. The element `Para` of the according `GUI_WIDGET_CREATE_INFO` structure is not used. The element `Flags` is used according to the parameter `ExFlags` of the function `LISTBOX_CreateEx()`.

### 6.2.16.5.1.6 LISTBOX\_CreateUser()

#### Description

Prototype explained at the beginning of the chapter as `<WIDGET>_CreateUser()` on page 993. For a detailed description of the parameters the function `LISTBOX_CreateEx()` can be referred to.

### 6.2.16.5.1.7 LISTBOX\_DecSel()

#### Description

Decrement the selection of the LISTBOX widget (moves the selection bar of a specified LISTBOX widget up by one item).

#### Prototype

```
void LISTBOX_DecSel(LISTBOX_Handle hObj);
```

#### Parameters

| Parameter         | Description               |
|-------------------|---------------------------|
| <code>hObj</code> | Handle of LISTBOX widget. |

#### Additional information

Note that the numbering of items always starts from the top with a value of 0; therefore, decrementing the selection will actually move the selection one row up.



### 6.2.16.5.1.8 LISTBOX\_DeleteItem()

#### Description

Deletes an element from a LISTBOX widget.

#### Prototype

```
void LISTBOX_DeleteItem(LISTBOX_Handle hObj,  
                        unsigned Index);
```

#### Parameters

| Parameter             | Description                                |
|-----------------------|--|
| <a href="#">hObj</a>  | Handle of LISTBOX widget.                  |
| <a href="#">Index</a> | Zero-based index of element to be deleted. |

### 6.2.16.5.1.9 LISTBOX\_EnableMotion()

#### Description

Enables motion support for the given LISTBOX widget.

#### Prototype

```
void LISTBOX_EnableMotion(LISTBOX_Handle hObj,
                          int           Flags);
```

#### Parameters

| Parameter             | Description               |
|-----------------------|---------------------------|
| <a href="#">hObj</a>  | Handle of LISTBOX widget. |
| <a href="#">Flags</a> | See table below.          |

| Permitted values for parameter <a href="#">Flags</a> |                                    |
|--|------------------------------------|
| 0  | Disables motion support.           |
| LISTBOX_CF_MOTION_H                                  | Enables horizontal motion support. |
| LISTBOX_CF_MOTION_V                                  | Enables vertical motion support.   |

#### Additional information

If motion support isn't enabled for the window manager, it will be activated automatically.

Note that motion support cannot be used in conjunction with scrollbars. This means that enabling motion support on one axis will remove a scrollbar attached to the same axis.

### 6.2.16.5.1.10 LISTBOX\_EnableWrapMode()

#### Description

Enables scrolling from the end to the beginning and vice versa. That avoids scrolling from the end through the whole content of the list. If for example the last set of items of the LISTBOX are currently visible and the user attempts scrolling to the next element the beginning of the list will be shown.

#### Prototype

```
void LISTBOX_EnableWrapMode(LISTBOX_Handle hObj,  
                             int OnOff);
```

#### Parameters

| Parameter          | Description  |
|--------------------|--|
| <code>hObj</code>  | Handle of LISTBOX widget.                            |
| <code>OnOff</code> | 1 for enabling wrap mode, 0 (default) for disabling. |

### 6.2.16.5.1.11 LISTBOX\_GetBkColor()

#### Description

Returns the background color of the widget.

#### Prototype

```
GUI_COLOR LISTBOX_GetBkColor(LISTBOX_Handle hObj,  
                             unsigned      Index);
```

#### Parameters

| Parameter             | Description  |
|-----------------------|--|
| <a href="#">hObj</a>  | Handle of LISTBOX widget.  |
| <a href="#">Index</a> | See <i>LISTBOX color indexes</i> on page 1577 for a full list of permitted values. |

#### Return value

The background color of the given widget.

### 6.2.16.5.1.12 LISTBOX\_GetDefaultBkColor()

#### Description

Returns the default background color for new LISTBOX widgets.

#### Prototype

```
GUI_COLOR LISTBOX_GetDefaultBkColor(unsigned Index);
```

#### Parameters

| Parameter             | Description  |
|-----------------------|--|
| <a href="#">Index</a> | See <i>LISTBOX color indexes</i> on page 1577 for a full list of permitted values. |

#### Return value

Default background color for new LISTBOX widgets.

### 6.2.16.5.1.13 LISTBOX\_GetDefaultFont()

#### Description

Returns the default font used for creating LISTBOX widgets.

#### Prototype

```
GUI_FONT *LISTBOX_GetDefaultFont(void);
```

#### Return value

Pointer to the default font.

#### 6.2.16.5.1.14 LISTBOX\_GetDefaultScrollStepH()

##### Description

Returns the default horizontal scroll step used for creating LISTBOX widgets. The horizontal scroll step defines the number of pixels to be scrolled if needed.

##### Prototype

```
int LISTBOX_GetDefaultScrollStepH(void);
```

##### Return value

Default horizontal scroll step.

### 6.2.16.5.1.15 LISTBOX\_GetDefaultTextAlign()

#### Description

Returns the default text alignment for new LISTBOX widgets.

#### Prototype

```
int LISTBOX_GetDefaultTextAlign(void);
```

#### Return value

Default text alignment for new LISTBOX widgets.

#### Additional information

For more information, refer to LISTBOX\_SetTextAlign().



### 6.2.16.5.1.16 LISTBOX\_GetDefaultTextColor()

#### Description

Returns the default text color for new LISTBOX widgets.

#### Prototype

```
GUI_COLOR LISTBOX_GetDefaultTextColor(unsigned Index);
```

#### Parameters

| Parameter             | Description  |
|-----------------------|--|
| <a href="#">Index</a> | See <i>LISTBOX color indexes</i> on page 1577 for a full list of permitted values. |

#### Return value

Default text color for new LISTBOX widgets.

### 6.2.16.5.1.17 LISTBOX\_GetFont()

#### Description

Returns a pointer to the font used to display the text of the LISTBOX widget.

#### Prototype

```
GUI_FONT *LISTBOX_GetFont(LISTBOX_Handle hObj);
```

#### Parameters

| Parameter            | Description               |
|----------------------|---------------------------|
| <a href="#">hObj</a> | Handle of LISTBOX widget. |

#### Return value

Pointer to the font used to display the text of the LISTBOX widget.

### 6.2.16.5.1.18 LISTBOX\_GetItemDisabled()

#### Description

Returns if the given item of the LISTBOX widget has been disabled.

#### Prototype

```
int LISTBOX_GetItemDisabled(LISTBOX_Handle hObj,  
                           unsigned Index);
```

#### Parameters

| Parameter             | Description               |
|-----------------------|---------------------------|
| <a href="#">hObj</a>  | Handle of LISTBOX widget. |
| <a href="#">Index</a> | Zero based index of item. |

#### Return value

1 if item has been disabled  
0 if not.

### 6.2.16.5.1.19 LISTBOX\_GetItemSel()

#### Description

Returns the selection state of the given LISTBOX item. The selection state of a LISTBOX item can be modified in multi selection mode only.

#### Prototype

```
int LISTBOX_GetItemSel(LISTBOX_Handle hObj,  
                      unsigned      Index);
```

#### Parameters

| Parameter             | Description               |
|-----------------------|---------------------------|
| <a href="#">hObj</a>  | Handle of LISTBOX widget. |
| <a href="#">Index</a> | Zero based index of item. |

#### Return value

1        if item has been selected  
0        if not.

### 6.2.16.5.1.20 LISTBOX\_GetItemSpacing()

#### Description

This function returns the distance between the different items of a LISTBOX.

#### Prototype

```
unsigned LISTBOX_GetItemSpacing(LISTBOX_Handle hObj);
```

#### Parameters

| Parameter            | Description               |
|----------------------|---------------------------|
| <a href="#">hObj</a> | Handle of LISTBOX widget. |

#### Return value

The distance between the items in pixel.

### 6.2.16.5.1.21 LISTBOX\_GetItemText()

#### Description

Returns the text of the given item of the LISTBOX widget.

#### Prototype

```
void LISTBOX_GetItemText(LISTBOX_Handle hObj,  
                        unsigned Index,  
                        char * pBuffer,  
                        int MaxSize);
```

#### Parameters

| Parameter               | Description                               |
|-------------------------|---|
| <a href="#">hObj</a>    | Handle of LISTBOX widget.                 |
| <a href="#">Index</a>   | Zero based item index.                    |
| <a href="#">pBuffer</a> | Pointer to buffer to store the item text. |
| <a href="#">MaxSize</a> | Size of the buffer.                       |

#### Additional information

The function copies the text of the given LISTBOX item into the given buffer.

### 6.2.16.5.1.22 LISTBOX\_GetMulti()

#### Description

Returns if the multi selection mode of the given LISTBOX widget is active.

#### Prototype

```
int LISTBOX_GetMulti(LISTBOX_Handle hObj);
```

#### Parameters

| Parameter            | Description               |
|----------------------|---------------------------|
| <a href="#">hObj</a> | Handle of LISTBOX widget. |

#### Additional information

1        if active  
0        if not.

### 6.2.16.5.1.23 LISTBOX\_GetNumItems()

#### Description

Returns the number of items in a specified LISTBOX widget.

#### Prototype

```
unsigned LISTBOX_GetNumItems(LISTBOX_Handle hObj);
```

#### Parameters

| Parameter            | Description               |
|----------------------|---------------------------|
| <a href="#">hObj</a> | Handle of LISTBOX widget. |

#### Return value

Number of items in the LISTBOX widget.



### 6.2.16.5.1.24 LISTBOX\_GetOwner()

#### Description

Returns the 'owner' of the widget. If it does not have an 'owner' it returns its parent.

#### Prototype

```
WM_HWIN LISTBOX_GetOwner(LISTBOX_Handle hObj);
```

#### Parameters

| Parameter            | Description               |
|----------------------|---------------------------|
| <a href="#">hObj</a> | Handle of LISTBOX widget. |

#### Return value

Owner or parent of the widget.

#### Additional information

A LISTBOX is used to represent the list of a DROPDOWN widget in expanded state. In that case the 'owner' is the DROPDOWN widget.

### 6.2.16.5.1.25 LISTBOX\_GetScrollStepH()

#### Description

Returns the horizontal scroll step of the given LISTBOX widget.

#### Prototype

```
int LISTBOX_GetScrollStepH(LISTBOX_Handle hObj);
```

#### Parameters

| Parameter            | Description               |
|----------------------|---------------------------|
| <a href="#">hObj</a> | Handle of LISTBOX widget. |

#### Return value

Horizontal scroll step of the given LISTBOX widget.

### 6.2.16.5.1.26 LISTBOX\_GetSel()

#### Description

Returns the zero based index of the currently selected item in a specified LISTBOX widget. In multi selection mode the function returns the index of the focused element.

#### Prototype

```
int LISTBOX_GetSel(LISTBOX_Handle hObj);
```

#### Parameters

| Parameter         | Description               |
|-------------------|---------------------------|
| <code>hObj</code> | Handle of LISTBOX widget. |

#### Return value

Zero-based index of the currently selected item.

#### Additional information

If no element has been selected the function returns -1.

### 6.2.16.5.1.27 LISTBOX\_GetTextAlign()

#### Description

Returns the text alignment of the given LISTBOX widget.

#### Prototype

```
int LISTBOX_GetTextAlign(LISTBOX_Handle hObj);
```

#### Parameters

| Parameter            | Description               |
|----------------------|---------------------------|
| <a href="#">hObj</a> | Handle of LISTBOX widget. |

#### Return value

Text alignment of the given LISTBOX widget.

#### Additional information

For more information, refer to [LISTBOX\\_SetTextAlign\(\)](#).

### 6.2.16.5.1.28 LISTBOX\_GetTextColor()

#### Description

Returns the text color of the widget.

#### Prototype

```
GUI_COLOR LISTBOX_GetTextColor(LISTBOX_Handle hObj,  
                               unsigned Index);
```

#### Parameters

| Parameter             | Description  |
|-----------------------|--|
| <a href="#">hObj</a>  | Handle of LISTBOX widget.  |
| <a href="#">Index</a> | See <i>LISTBOX color indexes</i> on page 1577 for a full list of permitted values. |

#### Return value

The text color of the given widget.

### 6.2.16.5.1.29 LISTBOX\_GetUserData()

#### Description

Prototype explained at the beginning of the chapter as `<WIDGET>_GetUserData()` on page 994.

### 6.2.16.5.1.30 LISTBOX\_GetVisItemIndices()

#### Description

Retrieves the index of the first and last visible item. The function also returns the total number of visible items.

#### Prototype

```
U32 LISTBOX_GetVisItemIndices(LISTBOX_Handle hObj,
                             int * pFirst,
                             int * pLast);
```

#### Parameters

| Parameter           | Description  |
|---------------------|--|
| <code>hObj</code>   | Handle to a LISTVIEW widget  |
| <code>pFirst</code> | Pointer to an integer that stores the zero-based index of the first visible row of the LISTVIEW. |
| <code>pLast</code>  | Pointer to an integer that stores the zero-based index of the last visible row of the LISTVIEW.  |

#### Return value

= -1 Error.  
 ≠ -1 Number of visible items.

#### Additional information

This function also takes partially visible items into account. By using the function `LISTBOX_IsItemPartiallyVisible()`, it can be checked if a row is only partially visible, fully visible or not visible at all.

### 6.2.16.5.1.31 LISTBOX\_IncSel()

#### Description

Increment the selection of the LISTBOX widget (moves the selection bar of a specified LISTBOX widget down by one item).

#### Prototype

```
void LISTBOX_IncSel(LISTBOX_Handle hObj);
```

#### Parameters

| Parameter             | Description               |
|-----------------------|---------------------------|
| <a href="#">hObj</a>  | Handle of LISTBOX widget. |
| <a href="#">Index</a> | See table below.          |

#### Additional information

Note that the numbering of items always starts from the top with a value of 0; therefore incrementing the selection will actually move the selection one row down.



### 6.2.16.5.1.32 LISTBOX\_InsertString()

#### Description

Inserts an element into a LISTBOX widget.

#### Prototype

```
void LISTBOX_InsertString(    LISTBOX_Handle  hObj,  
                             const char      * s,  
                             unsigned        Index);
```

#### Parameters

| Parameter             | Description                                 |
|-----------------------|---|
| <a href="#">hObj</a>  | Handle of LISTBOX widget.                   |
| <a href="#">s</a>     | Pointer to string to be inserted.           |
| <a href="#">Index</a> | Zero based index of element to be inserted. |

### 6.2.16.5.1.33 LISTBOX\_InvalidateItem()

#### Description

Invalidates an item of a owner drawn LISTBOX widget.

#### Prototype

```
void LISTBOX_InvalidateItem(LISTBOX_Handle hObj,
                           int Index);
```

#### Parameters

| Parameter             | Description  |
|-----------------------|--|
| <a href="#">hObj</a>  | Handle of LISTBOX widget.  |
| <a href="#">Index</a> | Zero based index of element to be invalidated or LISTBOX_ALL_ITEMS if all items should be invalidated. |

#### Additional information

This function only needs to be called if an item of an owner drawn LISTBOX widget has been changed. If a LISTBOX API function (like `LISTBOX_SetString()`) has been used to modify a LISTBOX item `LISTBOX_InvalidateItem()` does not need to be called. It needs to be called if the user decides, that for example the vertical size of an item has been changed. With other words if no LISTBOX API function has been used to modify the item this function needs to be called.

#### LISTBOX\_ALL\_ITEMS

If all items of a LISTBOX should be invalidated use this define as [Index](#) parameter.

### 6.2.16.5.1.34 LISTBOX\_IsItemPartiallyVisible()

#### Description

Returns if an item of the LISTBOX is partially visible, fully visible or not visible at all.

#### Prototype

```
U32 LISTBOX_IsItemPartiallyVisible(LISTBOX_Handle hObj,  
                                   int Index);
```

#### Parameters

| Parameter             | Description                                |
|-----------------------|--|
| <a href="#">hObj</a>  | Handle to a LISTVIEW widget                |
| <a href="#">Index</a> | Zero-based index of the row to be checked. |

#### Return value

- 1 Item is fully visible.
- 0 Item is not visible at all.
- 1 Item is partially visible.

### 6.2.16.5.1.35 LISTBOX\_OwnerDraw()

#### Description

Default function to handle a LISTBOX entry.

#### Prototype

```
int LISTBOX_OwnerDraw(const WIDGET_ITEM_DRAW_INFO * pDrawItemInfo);
```

#### Parameters

| Parameter                  | Description                                   |
|----------------------------|---|
| <code>pDrawItemInfo</code> | Pointer to a WIDGET_ITEM_DRAW_INFO structure. |

#### Additional information

This function is useful if `LISTBOX_SetOwnerDraw()` has been used. It can be used from your drawing function to retrieve the original x size of a LISTBOX entry and/or to display the text of a LISTBOX entry and should be called for all unhandled commands. For more information, refer to the section explaining user drawn widgets, `LISTBOX_SetOwnerDraw()` and to the provided example.

### 6.2.16.5.1.36 LISTBOX\_SetAutoScrollH()

#### Description

Enables/disables the automatic use of a horizontal scroll bar.

#### Prototype

```
void LISTBOX_SetAutoScrollH(LISTBOX_Handle hObj,
                           int           State);
```

#### Parameters

| Parameter          | Description               |
|--------------------|---------------------------|
| <code>hObj</code>  | Handle of LISTBOX widget. |
| <code>OnOff</code> | See table below.          |

| Permitted values for parameter <code>OnOff</code> |   |
|---|---|
| 0   | Disable automatic use of a horizontal scroll bar. |
| 1   | Enable automatic use of a horizontal scroll bar.  |

#### Additional information

If enabled the LISTBOX widget checks if all elements fits into the LISTBOX widget. If not a horizontal scroll bar will be attached to the window.

### 6.2.16.5.1.37 LISTBOX\_SetAutoScrollV()

#### Description

Enables/disables the automatic use of a vertical scroll bar.

#### Prototype

```
void LISTBOX_SetAutoScrollV(LISTBOX_Handle hObj,
                           int             State);
```

#### Parameters

| Parameter             | Description               |
|-----------------------|---------------------------|
| <a href="#">hObj</a>  | Handle of LISTBOX widget. |
| <a href="#">OnOff</a> | See table below.          |

| Permitted values for parameter <a href="#">OnOff</a> |   |
|--|---|
| 0  | Disable automatic use of a vertical scroll bar. |
| 1  | Enable automatic use of a vertical scroll bar.  |

#### Additional information

If enabled the LISTBOX widget checks if all elements fits into the LISTBOX widget. If not a vertical scroll bar will be added.

### 6.2.16.5.1.38 LISTBOX\_SetBkColor()

#### Description

Sets the background color of the LISTBOX widget.

#### Prototype

```
void LISTBOX_SetBkColor(LISTBOX_Handle hObj,  
                        unsigned      Index,  
                        GUI_COLOR     color);
```

#### Parameters

| Parameter             | Description  |
|-----------------------|--|
| <a href="#">hObj</a>  | Handle of LISTBOX widget.  |
| <a href="#">Index</a> | See <i>LISTBOX color indexes</i> on page 1577 for a full list of permitted values. |
| <a href="#">Color</a> | <a href="#">Color</a> to be set.   |

### 6.2.16.5.1.39 LISTBOX\_SetDefaultBkColor()

#### Description

Sets the default background color for new LISTBOX widgets.

#### Prototype

```
void LISTBOX_SetDefaultBkColor(unsigned Index,  
                               GUI_COLOR Color);
```

#### Parameters

| Parameter             | Description  |
|-----------------------|--|
| <a href="#">Index</a> | See <i>LISTBOX color indexes</i> on page 1577 for a full list of permitted values. |
| <a href="#">Color</a> | Desired background color.  |



#### 6.2.16.5.1.40 LISTBOX\_SetDefaultFont()

##### Description

Sets the default font used for creating LISTBOX widgets.

##### Prototype

```
void LISTBOX_SetDefaultFont(const GUI_FONT * pFont);
```

##### Parameters

| Parameter          | Description          |
|--------------------|----------------------|
| <code>pFont</code> | Pointer to the font. |

#### 6.2.16.5.1.41 LISTBOX\_SetDefaultScrollStepH()

##### Description

Sets the default horizontal scroll step used when creating a LISTBOX widget.

##### Prototype

```
void LISTBOX_SetDefaultScrollStepH(int Value);
```

##### Parameters

| Parameter | Description                      |
|-----------|----------------------------------|
| Value     | Number of pixels to be scrolled. |

### 6.2.16.5.1.42 LISTBOX\_SetDefaultTextAlign()

#### Description

Sets the default text alignment for new LISTBOX widgets.

#### Prototype

```
void LISTBOX_SetDefaultTextAlign(int Align);
```

#### Parameters

| Parameter             | Description                                     |
|-----------------------|---|
| <a href="#">Align</a> | Default text alignment for new LISTBOX widgets. |

#### Additional information

For more information, refer to `LISTBOX_SetTextAlign()`.

### 6.2.16.5.1.43 LISTBOX\_SetDefaultTextColor()

#### Description

Sets the default text color for new LISTBOX widgets.

#### Prototype

```
void LISTBOX_SetDefaultTextColor(unsigned Index,  
                                GUI_COLOR Color);
```

#### Parameters

| Parameter             | Description  |
|-----------------------|--|
| <a href="#">Index</a> | See <i>LISTBOX color indexes</i> on page 1577 for a full list of permitted values. |
| <a href="#">Color</a> | Desired text color.  |

#### 6.2.16.5.1.44 LISTBOX\_SetFixedScrollPos()

##### Description

Enables the fixed scroll mode for the given LISTBOX widget.

##### Prototype

```
void LISTBOX_SetFixedScrollPos(LISTBOX_Handle hObj,  
                               U16           FixedScrollPos,  
                               U8           Mode);
```

##### Parameters

| Parameter                   | Description   |
|-----------------------------|---|
| <code>hObj</code>           | Handle of LISTBOX widget.   |
| <code>FixedScrollPos</code> | Index of the item the scroll position is fixed to.                              |
| <code>Mode</code>           | Sets the desired mode. See <i>LISTBOX fixed scroll mode flags</i> on page 1578. |

### 6.2.16.5.1.45 LISTBOX\_SetFont()

#### Description

Sets the font of the LISTBOX widget.

#### Prototype

```
void LISTBOX_SetFont(      LISTBOX_Handle  hObj,  
                        const GUI_FONT    * pFont);
```

#### Parameters

| Parameter          | Description               |
|--------------------|---------------------------|
| <code>hObj</code>  | Handle of LISTBOX widget. |
| <code>pFont</code> | Pointer to the font.      |

### 6.2.16.5.1.46 LISTBOX\_SetItemDisabled()

#### Description

Modifies the disable state of the given list item of the LISTBOX widget.

#### Prototype

```
void LISTBOX_SetItemDisabled(LISTBOX_Handle hObj,  
                             unsigned      Index,  
                             int           OnOff);
```

#### Parameters

| Parameter             | Description                           |
|-----------------------|---------------------------------------|
| <a href="#">hObj</a>  | Handle of LISTBOX widget.             |
| <a href="#">Index</a> | Zero based index of the LISTBOX item. |
| <a href="#">OnOff</a> | 1 for disabled, 0 for not disabled.   |

#### Additional information

When scrolling through a LISTBOX widget disabled items will be skipped. You can not scroll to a disabled item of a LISTBOX widget.

### 6.2.16.5.1.47 LISTBOX\_SetItemSel()

#### Description

Modifies the selection state of the given item of the LISTBOX widget.

#### Prototype

```
void LISTBOX_SetItemSel(LISTBOX_Handle hObj,  
                        unsigned Index,  
                        int OnOff);
```

#### Parameters



| Parameter             | Description                           |
|-----------------------|---------------------------------------|
| <a href="#">hObj</a>  | Handle of LISTBOX widget.             |
| <a href="#">Index</a> | Zero based index of the LISTBOX item. |
| <a href="#">OnOff</a> | 1 for selected, 0 for not selected.   |

#### Additional information

Setting the selection state of a LISTBOX item makes only sense when using the multi selection mode. See also `LISTBOX_SetMulti()`.



### 6.2.16.5.1.48 LISTBOX\_SetItemSpacing()

| Before  | After   |
|---|---|
|  |  |

#### Description

Sets an additional spacing below the items of a LISTBOX widget.

#### Prototype

```
void LISTBOX_SetItemSpacing(LISTBOX_Handle hObj,
                           unsigned Value);
```

#### Parameters

| Parameter | Description  |
|-----------|--|
| hObj      | Handle of LISTBOX widget.                                      |
| Value     | Number of pixels used as additional spacing between the items. |

### 6.2.16.5.1.49 LISTBOX\_SetMulti()

#### Description

Switches the multi selection mode of a LISTBOX on or off.

#### Prototype

```
void LISTBOX_SetMulti(LISTBOX_Handle hObj,  
                     int Mode);
```

#### Parameters

| Parameter         | Description               |
|-------------------|---------------------------|
| <code>hObj</code> | Handle of LISTBOX widget. |
| <code>Mode</code> | 0 for off, 1 for on.      |

#### Additional information

The multi selection mode enables the LISTBOX widget to have more than one selected element. Using the space key would toggle the selection state of a LISTBOX item.

### 6.2.16.5.1.50 LISTBOX\_SetOwnerDraw()

#### Description

Sets the LISTBOX widget to be owner drawn.

#### Prototype

```
void LISTBOX_SetOwnerDraw(LISTBOX_Handle      hObj,
                          WIDGET_DRAW_ITEM_FUNC * pfDrawItem);
```

#### Parameters

| Parameter               | Description                     |
|-------------------------|---------------------------------|
| <code>hObj</code>       | Handle of LISTBOX widget.       |
| <code>pfDrawItem</code> | Pointer to owner draw function. |

#### Supported commands

- `WIDGET_ITEM_GET_XSIZE`
- `WIDGET_ITEM_GET_YSIZE`
- `WIDGET_ITEM_DRAW`

#### Additional information

This function sets a function pointer to a function which will be called by the widget if a LISTBOX item has to be drawn and when the x or y size of a item is needed. It gives you the possibility to draw anything as LISTBOX item, not just plain text. `pfDrawItem` is a pointer to a application-defined function of type `WIDGET_DRAW_ITEM_FUNC` which is explained at the beginning of the chapter.

#### Note

An additional `WIDGET_ITEM_DRAW` command is sent to the OwnerDraw function with `ItemIndex = -1`. With this command, the empty area without an item at the bottom of the widget is drawn.

#### Structure of the user defined owner draw function

The following shows the structure of a typical owner draw function. It assumes that your LISTBOX entries are 30 pixels wider than and have the same height as the item drawn by the default function:

```
static int _OwnerDraw(const WIDGET_DRAW_ITEM_FUNC * pDrawItemInfo) {
    switch (pDrawItemInfo->Cmd) {
        case WIDGET_ITEM_GET_XSIZE:
            return LISTBOX_OwnerDraw(pDrawItemInfo) + 30; /* Returns the default xSize+10
            */
        case WIDGET_ITEM_DRAW:

            /* Your code to be added to draw the LISTBOX item */

            return 0;
    }
    return LISTBOX_OwnerDraw(pDrawItemInfo); /* Def. function for unhandled cmds
    */
}
```

## Example



The source code of this example is available in the examples as `WIDGET_ListBoxOwner-Draw.c`.

### 6.2.16.5.1.51 LISTBOX\_SetScrollbarColor()

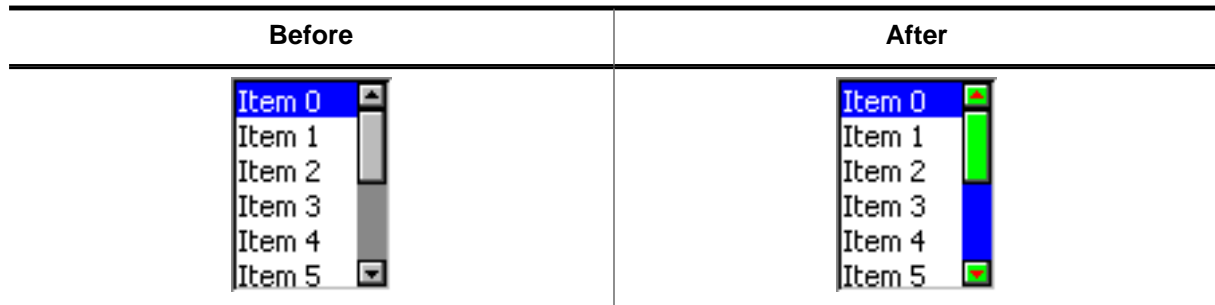

#### Description

Sets the colors of the optional scroll bar.

#### Prototype

```
void LISTBOX_SetScrollbarColor(LISTBOX_Handle hObj,
                               unsigned      Index,
                               GUI_COLOR     Color);
```

#### Parameters

| Parameter | Description   |
|-----------|---|
| hObj      | Handle of LISTBOX widget.   |
| Index     | Index of desired item. See <i>SCROLLBAR color indexes</i> on page 2449 for a full list of permitted values. |
| Color     | Color to be used.   |

### 6.2.16.5.1.52 LISTBOX\_SetScrollbarWidth()

#### Description

Sets the width of the scroll bars used by the given LISTBOX widget.

#### Prototype

```
void LISTBOX_SetScrollbarWidth(LISTBOX_Handle hObj,  
                               unsigned      Width);
```

#### Parameters

| Parameter          | Description   |
|--------------------|---|
| <code>hObj</code>  | Handle of LISTBOX widget.   |
| <code>Width</code> | <code>Width</code> of the scroll bar(s) used by the given LISTBOX widget. |

### 6.2.16.5.1.53 LISTBOX\_SetScrollStepH()

#### Description

Sets the horizontal scroll step of the given LISTBOX widget. The horizontal scroll step defines the number of pixels to be scrolled if needed.

#### Prototype

```
void LISTBOX_SetScrollStepH(LISTBOX_Handle hObj,  
                             int Value);
```

#### Parameters

| Parameter             | Description                      |
|-----------------------|----------------------------------|
| <a href="#">hObj</a>  | Handle of LISTBOX widget.        |
| <a href="#">Value</a> | Number of pixels to be scrolled. |

### 6.2.16.5.1.54 LISTBOX\_SetSel()

#### Description

Sets the selected item of a specified LISTBOX widget.

#### Prototype

```
void LISTBOX_SetSel(LISTBOX_Handle hObj,  
                   int           NewSel);
```

#### Parameters

| Parameter            | Description               |
|----------------------|---------------------------|
| <a href="#">hObj</a> | Handle of LISTBOX widget. |
| <a href="#">Sel</a>  | Element to be selected.   |



### 6.2.16.5.1.55 LISTBOX\_SetString()

#### Description

Sets the content of the given item.

#### Prototype

```
void LISTBOX_SetString(    LISTBOX_Handle  hObj,  
                          const char      * s,  
                          unsigned        Index);
```

#### Parameters

| Parameter             | Description                                   |
|-----------------------|---|
| <a href="#">hObj</a>  | Handle of LISTBOX widget.                     |
| <a href="#">s</a>     | Pointer to string containing the new content. |
| <a href="#">Index</a> | Zero-based index of element to be changed.    |

### 6.2.16.5.1.56 LISTBOX\_SetTextAlign()

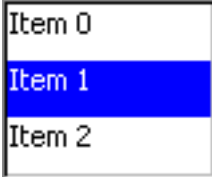
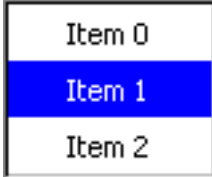
| Before  | After  |
|---|--|
|  |  |

#### Description

The function sets the text alignment used to display each item of the LISTBOX widget.

#### Prototype

```
void LISTBOX_SetTextAlign(LISTBOX_Handle hObj,
                          int            Align);
```

#### Parameters

| Parameter          | Description  |
|--------------------|--|
| <code>hObj</code>  | Handle of LISTBOX widget.  |
| <code>Align</code> | Text alignment to be used. List of flags can be found under <i>Text alignment flags</i> on page 252. |

#### Additional information

The default alignment of list boxes is `GUI_TA_LEFT`. Per default the height of each item depends on the height of the font used to render the LISTBOX items. So vertical text alignment makes only sense if the function `LISTBOX_SetItemSpacing()` is used to set an additional spacing below the items.

### 6.2.16.5.1.57 LISTBOX\_SetTextColor()

#### Description

Sets the text color of the LISTBOX widget.

#### Prototype

```
GUI_COLOR LISTBOX_SetTextColor(LISTBOX_Handle hObj,  
                               unsigned      Index,  
                               GUI_COLOR     Color);
```

#### Parameters

| Parameter             | Description  |
|-----------------------|--|
| <a href="#">hObj</a>  | Handle of LISTBOX widget.  |
| <a href="#">Index</a> | <a href="#">Index</a> for text color (see <i>LISTBOX_SetBackColor</i> on page ). |
| <a href="#">Color</a> | <a href="#">Color</a> to be set.   |

### 6.2.16.5.1.58 LISTBOX\_SetUserData()

#### Description

Prototype explained at the beginning of the chapter as `<WIDGET>_SetUserData()` on page 995.

## 6.2.16.5.2 Defines

### 6.2.16.5.2.1 LISTBOX color indexes

#### Description

Color indexes used by the LISTBOX widget.

#### Definition

```
#define LISTBOX_CI_UNSEL      0
#define LISTBOX_CI_SEL       1
#define LISTBOX_CI_SELFOCUS  2
#define LISTBOX_CI_DISABLED  3
```

#### Symbols

| Definition                          | Description                           |
|-------------------------------------|---------------------------------------|
| <a href="#">LISTBOX_CI_UNSEL</a>    | Color of unselected element.          |
| <a href="#">LISTBOX_CI_SEL</a>      | Color of selected element.            |
| <a href="#">LISTBOX_CI_SELFOCUS</a> | Color of selected element with focus. |
| <a href="#">LISTBOX_CI_DISABLED</a> | Color of disabled element.            |

### 6.2.16.5.2 LISTBOX fixed scroll mode flags

#### Description

Defines used for the fixed scroll mode of the widget. Refer to `LISTBOX_SetFixedScrollPos()` for more information.

#### Definition

```
#define LISTBOX_FM_OFF      0
#define LISTBOX_FM_ON      1
#define LISTBOX_FM_CENTER  2
```

#### Symbols

| Definition                        | Description                                    |
|-----------------------------------|--|
| <a href="#">LISTBOX_FM_OFF</a>    | Disables the fixed scroll mode.                |
| <a href="#">LISTBOX_FM_ON</a>     | Enables the fixed scroll mode.                 |
| <a href="#">LISTBOX_FM_CENTER</a> | Tries to keep the selected item in the center. |

## 6.2.16.6 Examples

The `Sample` folder contains the following examples which show how the widget can be used:

- `WIDGET_SimpleListBox.c`
- `WIDGET_ListBox.c`

Note that several other examples also make use of this widget and may also be helpful to get familiar with the widget.

### Screenshot of `WIDGET_SimpleListBox.c`



### Screenshot(s) of `WIDGET_ListBox.c`



## 6.2.17 LISTVIEW: Listview widget

LISTVIEW widgets are used to select one element of a list with several columns. To manage the columns a LISTVIEW widget contains a HEADER widget. A LISTVIEW can be created without a surrounding frame window or as a child window of a FRAMEWIN widget. As items in a listview are selected, they appear highlighted. Note that the background color of a selected item depends on whether the LISTVIEW window has input focus. The table below shows the appearance of the LISTVIEW widget:

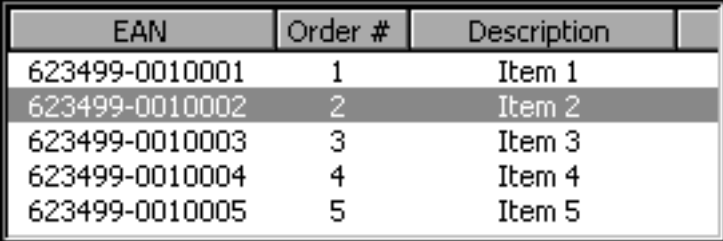
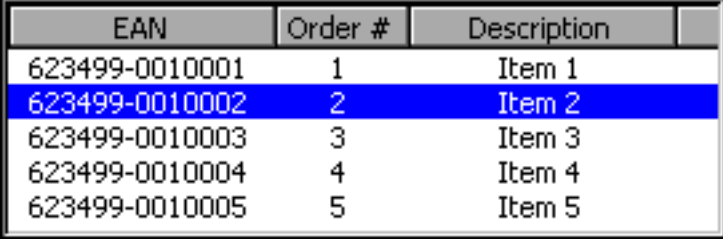
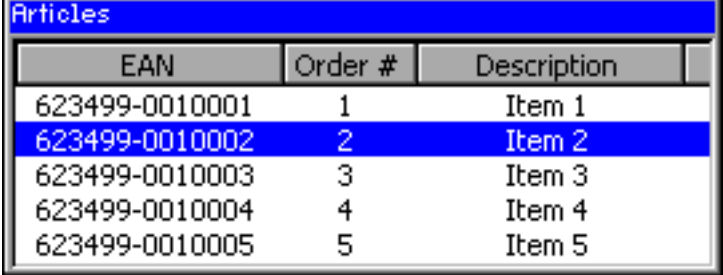
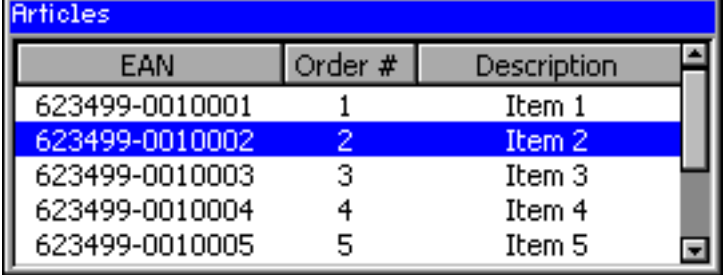
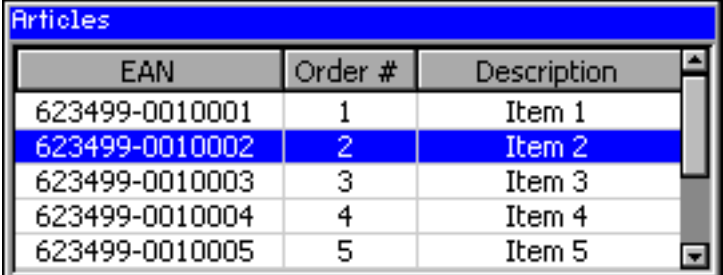
| Description   | LISTVIEW widget  |             |         |             |                |         |             |                |   |        |                |   |        |                |   |        |                |   |        |                |   |        |
|---|--|-------------|---------|-------------|----------------|---------|-------------|----------------|---|--------|----------------|---|--------|----------------|---|--------|----------------|---|--------|----------------|---|--------|
| No focus<br>No surrounding FRAMEWIN<br>No SCROLLBAR attached<br>Grid lines not visible          |  <table border="1" data-bbox="616 501 1342 741"> <thead> <tr> <th>EAN</th> <th>Order #</th> <th>Description</th> </tr> </thead> <tbody> <tr> <td>623499-0010001</td> <td>1</td> <td>Item 1</td> </tr> <tr> <td>623499-0010002</td> <td>2</td> <td>Item 2</td> </tr> <tr> <td>623499-0010003</td> <td>3</td> <td>Item 3</td> </tr> <tr> <td>623499-0010004</td> <td>4</td> <td>Item 4</td> </tr> <tr> <td>623499-0010005</td> <td>5</td> <td>Item 5</td> </tr> </tbody> </table>  | EAN         | Order # | Description | 623499-0010001 | 1       | Item 1      | 623499-0010002 | 2 | Item 2 | 623499-0010003 | 3 | Item 3 | 623499-0010004 | 4 | Item 4 | 623499-0010005 | 5 | Item 5 |                |   |        |
| EAN   | Order #  | Description |         |             |                |         |             |                |   |        |                |   |        |                |   |        |                |   |        |                |   |        |
| 623499-0010001  | 1  | Item 1      |         |             |                |         |             |                |   |        |                |   |        |                |   |        |                |   |        |                |   |        |
| 623499-0010002  | 2  | Item 2      |         |             |                |         |             |                |   |        |                |   |        |                |   |        |                |   |        |                |   |        |
| 623499-0010003  | 3  | Item 3      |         |             |                |         |             |                |   |        |                |   |        |                |   |        |                |   |        |                |   |        |
| 623499-0010004  | 4  | Item 4      |         |             |                |         |             |                |   |        |                |   |        |                |   |        |                |   |        |                |   |        |
| 623499-0010005  | 5  | Item 5      |         |             |                |         |             |                |   |        |                |   |        |                |   |        |                |   |        |                |   |        |
| Has input focus<br>No surrounding FRAMEWIN<br>No SCROLLBAR attached<br>Grid lines not visible   |  <table border="1" data-bbox="616 770 1342 1010"> <thead> <tr> <th>EAN</th> <th>Order #</th> <th>Description</th> </tr> </thead> <tbody> <tr> <td>623499-0010001</td> <td>1</td> <td>Item 1</td> </tr> <tr> <td>623499-0010002</td> <td>2</td> <td>Item 2</td> </tr> <tr> <td>623499-0010003</td> <td>3</td> <td>Item 3</td> </tr> <tr> <td>623499-0010004</td> <td>4</td> <td>Item 4</td> </tr> <tr> <td>623499-0010005</td> <td>5</td> <td>Item 5</td> </tr> </tbody> </table>  | EAN         | Order # | Description | 623499-0010001 | 1       | Item 1      | 623499-0010002 | 2 | Item 2 | 623499-0010003 | 3 | Item 3 | 623499-0010004 | 4 | Item 4 | 623499-0010005 | 5 | Item 5 |                |   |        |
| EAN   | Order #  | Description |         |             |                |         |             |                |   |        |                |   |        |                |   |        |                |   |        |                |   |        |
| 623499-0010001  | 1  | Item 1      |         |             |                |         |             |                |   |        |                |   |        |                |   |        |                |   |        |                |   |        |
| 623499-0010002  | 2  | Item 2      |         |             |                |         |             |                |   |        |                |   |        |                |   |        |                |   |        |                |   |        |
| 623499-0010003  | 3  | Item 3      |         |             |                |         |             |                |   |        |                |   |        |                |   |        |                |   |        |                |   |        |
| 623499-0010004  | 4  | Item 4      |         |             |                |         |             |                |   |        |                |   |        |                |   |        |                |   |        |                |   |        |
| 623499-0010005  | 5  | Item 5      |         |             |                |         |             |                |   |        |                |   |        |                |   |        |                |   |        |                |   |        |
| Has input focus<br>With surrounding FRAMEWIN<br>No SCROLLBAR attached<br>Grid lines not visible |  <table border="1" data-bbox="616 1039 1342 1312"> <thead> <tr> <th colspan="3">Articles</th> </tr> <tr> <th>EAN</th> <th>Order #</th> <th>Description</th> </tr> </thead> <tbody> <tr> <td>623499-0010001</td> <td>1</td> <td>Item 1</td> </tr> <tr> <td>623499-0010002</td> <td>2</td> <td>Item 2</td> </tr> <tr> <td>623499-0010003</td> <td>3</td> <td>Item 3</td> </tr> <tr> <td>623499-0010004</td> <td>4</td> <td>Item 4</td> </tr> <tr> <td>623499-0010005</td> <td>5</td> <td>Item 5</td> </tr> </tbody> </table> | Articles    |         |             | EAN            | Order # | Description | 623499-0010001 | 1 | Item 1 | 623499-0010002 | 2 | Item 2 | 623499-0010003 | 3 | Item 3 | 623499-0010004 | 4 | Item 4 | 623499-0010005 | 5 | Item 5 |
| Articles  |  |             |         |             |                |         |             |                |   |        |                |   |        |                |   |        |                |   |        |                |   |        |
| EAN   | Order #  | Description |         |             |                |         |             |                |   |        |                |   |        |                |   |        |                |   |        |                |   |        |
| 623499-0010001  | 1  | Item 1      |         |             |                |         |             |                |   |        |                |   |        |                |   |        |                |   |        |                |   |        |
| 623499-0010002  | 2  | Item 2      |         |             |                |         |             |                |   |        |                |   |        |                |   |        |                |   |        |                |   |        |
| 623499-0010003  | 3  | Item 3      |         |             |                |         |             |                |   |        |                |   |        |                |   |        |                |   |        |                |   |        |
| 623499-0010004  | 4  | Item 4      |         |             |                |         |             |                |   |        |                |   |        |                |   |        |                |   |        |                |   |        |
| 623499-0010005  | 5  | Item 5      |         |             |                |         |             |                |   |        |                |   |        |                |   |        |                |   |        |                |   |        |
| Has input focus<br>With surrounding FRAMEWIN<br>SCROLLBAR attached<br>Grid lines not visible    |  <table border="1" data-bbox="616 1344 1342 1617"> <thead> <tr> <th colspan="3">Articles</th> </tr> <tr> <th>EAN</th> <th>Order #</th> <th>Description</th> </tr> </thead> <tbody> <tr> <td>623499-0010001</td> <td>1</td> <td>Item 1</td> </tr> <tr> <td>623499-0010002</td> <td>2</td> <td>Item 2</td> </tr> <tr> <td>623499-0010003</td> <td>3</td> <td>Item 3</td> </tr> <tr> <td>623499-0010004</td> <td>4</td> <td>Item 4</td> </tr> <tr> <td>623499-0010005</td> <td>5</td> <td>Item 5</td> </tr> </tbody> </table> | Articles    |         |             | EAN            | Order # | Description | 623499-0010001 | 1 | Item 1 | 623499-0010002 | 2 | Item 2 | 623499-0010003 | 3 | Item 3 | 623499-0010004 | 4 | Item 4 | 623499-0010005 | 5 | Item 5 |
| Articles  |  |             |         |             |                |         |             |                |   |        |                |   |        |                |   |        |                |   |        |                |   |        |
| EAN   | Order #  | Description |         |             |                |         |             |                |   |        |                |   |        |                |   |        |                |   |        |                |   |        |
| 623499-0010001  | 1  | Item 1      |         |             |                |         |             |                |   |        |                |   |        |                |   |        |                |   |        |                |   |        |
| 623499-0010002  | 2  | Item 2      |         |             |                |         |             |                |   |        |                |   |        |                |   |        |                |   |        |                |   |        |
| 623499-0010003  | 3  | Item 3      |         |             |                |         |             |                |   |        |                |   |        |                |   |        |                |   |        |                |   |        |
| 623499-0010004  | 4  | Item 4      |         |             |                |         |             |                |   |        |                |   |        |                |   |        |                |   |        |                |   |        |
| 623499-0010005  | 5  | Item 5      |         |             |                |         |             |                |   |        |                |   |        |                |   |        |                |   |        |                |   |        |
| Has input focus<br>With surrounding FRAMEWIN<br>SCROLLBAR attached<br>Grid lines visible        |  <table border="1" data-bbox="616 1644 1342 1917"> <thead> <tr> <th colspan="3">Articles</th> </tr> <tr> <th>EAN</th> <th>Order #</th> <th>Description</th> </tr> </thead> <tbody> <tr> <td>623499-0010001</td> <td>1</td> <td>Item 1</td> </tr> <tr> <td>623499-0010002</td> <td>2</td> <td>Item 2</td> </tr> <tr> <td>623499-0010003</td> <td>3</td> <td>Item 3</td> </tr> <tr> <td>623499-0010004</td> <td>4</td> <td>Item 4</td> </tr> <tr> <td>623499-0010005</td> <td>5</td> <td>Item 5</td> </tr> </tbody> </table> | Articles    |         |             | EAN            | Order # | Description | 623499-0010001 | 1 | Item 1 | 623499-0010002 | 2 | Item 2 | 623499-0010003 | 3 | Item 3 | 623499-0010004 | 4 | Item 4 | 623499-0010005 | 5 | Item 5 |
| Articles  |  |             |         |             |                |         |             |                |   |        |                |   |        |                |   |        |                |   |        |                |   |        |
| EAN   | Order #  | Description |         |             |                |         |             |                |   |        |                |   |        |                |   |        |                |   |        |                |   |        |
| 623499-0010001  | 1  | Item 1      |         |             |                |         |             |                |   |        |                |   |        |                |   |        |                |   |        |                |   |        |
| 623499-0010002  | 2  | Item 2      |         |             |                |         |             |                |   |        |                |   |        |                |   |        |                |   |        |                |   |        |
| 623499-0010003  | 3  | Item 3      |         |             |                |         |             |                |   |        |                |   |        |                |   |        |                |   |        |                |   |        |
| 623499-0010004  | 4  | Item 4      |         |             |                |         |             |                |   |        |                |   |        |                |   |        |                |   |        |                |   |        |
| 623499-0010005  | 5  | Item 5      |         |             |                |         |             |                |   |        |                |   |        |                |   |        |                |   |        |                |   |        |



**Note**

All LISTVIEW-related routines are located in the file(s) LISTVIEW\*.c, LISTVIEW.h. All identifiers are prefixed LISTVIEW.

**6.2.17.1 Configuration options**

| Type | Macro                         | Default                            | Description  |
|------|-------------------------------|------------------------------------|--|
| N    | LISTVIEW_ALIGN_DEFAULT        | GUI_TA_VCENTER  <br>GUI_TA_HCENTER | Default text alignment.                                |
| N    | LISTVIEW_BKCOLOR0_DEFAULT     | GUI_WHITE                          | Background color, unselected state.                    |
| N    | LISTVIEW_BKCOLOR1_DEFAULT     | GUI_GRAY                           | Background color, selected state without focus.        |
| N    | LISTVIEW_BKCOLOR2_DEFAULT     | GUI_BLUE                           | Background color, selected state with focus.           |
| N    | LISTVIEW_BKCOLOR3_DEFAULT     | GUI_LIGHTGRAY                      | Background color, disabled state.                      |
| S    | LISTVIEW_FONT_DEFAULT         | &GUI_Font13_1                      | Default font.  |
| N    | LISTVIEW_GRIDCOLOR_DEFAULT    | GUI_LIGHTGRAY                      | Color of grid lines (if shown).                        |
| N    | LISTVIEW_SCROLLSTEP_H_DEFAULT | 10                                 | Defines the number of pixels to be scrolled if needed. |
| N    | LISTVIEW_TEXTCOLOR0_DEFAULT   | GUI_BLACK                          | Text color, unselected state.                          |
| N    | LISTVIEW_TEXTCOLOR1_DEFAULT   | GUI_WHITE                          | Text color, selected state without focus.              |
| N    | LISTVIEW_TEXTCOLOR2_DEFAULT   | GUI_WHITE                          | Text color, selected state with focus.                 |
| N    | LISTVIEW_TEXTCOLOR3_DEFAULT   | GUI_GRAY                           | Text color, disabled state.                            |
| N    | LISTVIEW_WRAPMODE_DEFAULT     | GUI_WRAPMODE_NONE                  | Wrapping mode.   |

**6.2.17.2 Predefined IDs**

The following symbols define IDs which may be used to make LISTVIEW widgets distinguishable from creation.

```
#define GUI_ID_LISTVIEW0    0x200
#define GUI_ID_LISTVIEW1    0x201
#define GUI_ID_LISTVIEW2    0x202
#define GUI_ID_LISTVIEW3    0x203
#define GUI_ID_LISTVIEW4    0x204
#define GUI_ID_LISTVIEW5    0x205
#define GUI_ID_LISTVIEW6    0x206
#define GUI_ID_LISTVIEW7    0x207
#define GUI_ID_LISTVIEW8    0x208
#define GUI_ID_LISTVIEW9    0x209
```

### 6.2.17.3 Notification codes

The following events are sent from a LISTVIEW widget to its parent window as part of a WM\_NOTIFY\_PARENT message:

| Message                        | Description   |
|--------------------------------|---|
| WM_NOTIFICATION_CLICKED        | Widget has been clicked.  |
| WM_NOTIFICATION_RELEASED       | Widget has been released.   |
| WM_NOTIFICATION_MOVED_OUT      | Widget has been clicked and pointer has been moved out of the widget without releasing.                                       |
| WM_NOTIFICATION_SCROLL_CHANGED | The scroll position has changed either through an attached scrollbar or through motion support (see LISTVIEW_EnableMotion()). |
| WM_NOTIFICATION_SEL_CHANGED    | The selection of the list box has changed.  |

### 6.2.17.4 Keyboard reaction

The widget reacts to the following keys if it has the input focus:

| Key            | Reaction   |
|----------------|--|
| GUI_KEY_UP     | Moves the selection bar up.  |
| GUI_KEY_DOWN   | Moves the selection bar down.  |
| GUI_KEY_RIGHT  | If the total amount of the column width is > than the inside area of the listview, the content scrolls to the left.  |
| GUI_KEY_LEFT   | If the total amount of the column width is > than the inside area of the listview, the content scrolls to the right. |
| GUI_KEY_PGUP   | Moves the selection one page up.   |
| GUI_KEY_PGDOWN | Moves the selection one page down.   |
| GUI_KEY_HOME   | Moves the selection to the first element of the list.  |
| GUI_KEY_END    | Moves the selection to the last element of the list.   |

### 6.2.17.5 LISTVIEW API

The table below lists the available emWin LISTVIEW-related routines in alphabetical order. Detailed descriptions of the routines follow.

#### Functions

| Routine                                   | Description  |
|---|--|
| <a href="#">LISTVIEW_AddColumn()</a>      | Adds a column to a LISTVIEW.                           |
| <a href="#">LISTVIEW_AddRow()</a>         | Adds a row to a LISTVIEW.                              |
| <a href="#">LISTVIEW_Clear()</a>          | Removes all items from the LISTVIEW.                   |
| <a href="#">LISTVIEW_CompareDec()</a>     | Compare function for comparing 2 integer values.       |
| <a href="#">LISTVIEW_CompareText()</a>    | Compare function for comparing 2 strings.              |
| <a href="#">LISTVIEW_Create()</a>         | Creates a LISTVIEW widget. (Obsolete)                  |
| <a href="#">LISTVIEW_CreateAttached()</a> | Creates a LISTVIEW widget attached to a window.        |
| <a href="#">LISTVIEW_CreateEx()</a>       | Creates a LISTVIEW widget.                             |
| <a href="#">LISTVIEW_CreateIndirect()</a> | Creates a LISTVIEW widget from a resource table entry. |

| Routine                                       | Description  |
|---|--|
| <code>LISTVIEW_CreateUser()</code>            | Creates a LISTVIEW widget using extra bytes as user data.  |
| <code>LISTVIEW_DecSel()</code>                | Decrements selection.  |
| <code>LISTVIEW_DeleteAllRows()</code>         | Deletes all rows from the given LISTVIEW widget.   |
| <code>LISTVIEW_DeleteColumn()</code>          | Deletes the given column.  |
| <code>LISTVIEW_DeleteRow()</code>             | Deletes the given row.   |
| <code>LISTVIEW_DisableRow()</code>            | Sets the state of the given row to disabled.   |
| <code>LISTVIEW_DisableSort()</code>           | Disables sorting of the given LISTVIEW widget.   |
| <code>LISTVIEW_EnableCellSelect()</code>      | Enables or disables cell selection mode of the given LISTVIEW widget.  |
| <code>LISTVIEW_EnableMotion()</code>          | Enables motion support for the given LISTVIEW widget.  |
| <code>LISTVIEW_EnableRow()</code>             | The function sets the state of the given row to enabled.   |
| <code>LISTVIEW_EnableSort()</code>            | Enables sorting for the given LISTVIEW widget.   |
| <code>LISTVIEW_GetBkColor()</code>            | Returns the background color of the given LISTVIEW widget.   |
| <code>LISTVIEW_GetDefaultBkColor()</code>     | Gets the default background color for new LISTVIEW widgets.  |
| <code>LISTVIEW_GetDefaultFont()</code>        | Gets the default font for new LISTVIEW widgets.  |
| <code>LISTVIEW_GetDefaultGridColor()</code>   | Gets the default color of the grid lines for new LISTVIEW widgets.   |
| <code>LISTVIEW_GetDefaultScrollStepH()</code> | Gets the default scrolling distance for horizontal scrolling.  |
| <code>LISTVIEW_GetDefaultTextColor()</code>   | Gets the default text color for new LISTVIEW widgets.  |
| <code>LISTVIEW_GetFont()</code>               | Returns a pointer to the font used to display the text of the LISTVIEW widget.                               |
| <code>LISTVIEW_GetGridColor()</code>          | Returns the grid color of the LISTVIEW.  |
| <code>LISTVIEW_GetHeader()</code>             | Returns the handle of the HEADER widget.   |
| <code>LISTVIEW_GetItemRect()</code>           | Returns the rectangle of the given LISTVIEW cell by copying the coordinates to the given GUI_RECT structure. |
| <code>LISTVIEW_GetItemText()</code>           | Copies the text of the specified item to the given buffer.   |
| <code>LISTVIEW_GetItemTextLen()</code>        | Returns the length in characters of the given text item.   |
| <code>LISTVIEW_GetItemTextSorted()</code>     | Copies the text of the specified item to the given buffer.   |
| <code>LISTVIEW_GetLBorder()</code>            | Returns the size of the left border within a cell of a LISTVIEW.   |
| <code>LISTVIEW_GetNumColumns()</code>         | Returns the number of columns of the given LISTVIEW widget.  |
| <code>LISTVIEW_GetNumRows()</code>            | Returns the number of rows of the given LISTVIEW widget.   |
| <code>LISTVIEW_GetRBorder()</code>            | Returns the size of the right border within a cell of a LISTVIEW.  |

| Routine                                       | Description   |
|---|---|
| <code>LISTVIEW_GetScrollStepH()</code>        | Returns the currently set horizontal scrolling distance.                                    |
| <code>LISTVIEW_GetSel()</code>                | Returns the index of the currently selected row in a specified LISTVIEW widget.             |
| <code>LISTVIEW_GetSelCol()</code>             | Returns the index of the currently selected column.   |
| <code>LISTVIEW_GetSelUnsorted()</code>        | Returns the index of the currently selected row in unsorted state.                          |
| <code>LISTVIEW_GetTextAlign()</code>          | Returns the currently set text alignment for the given column.                              |
| <code>LISTVIEW_GetTextColor()</code>          | Returns the text color of the given LISTVIEW widget.  |
| <code>LISTVIEW_GetUserData()</code>           | Retrieves the data set with <code>LISTVIEW_SetUserData()</code> .                           |
| <code>LISTVIEW_GetUserDataRow()</code>        | Returns the user data of the given row.   |
| <code>LISTVIEW_GetVisRowIndices()</code>      | Retrieves the index of the first and last visible item.                                     |
| <code>LISTVIEW_GetWrapMode()</code>           | Returns the currently used mode for wrapping text.  |
| <code>LISTVIEW_IncSel()</code>                | Increments selection.   |
| <code>LISTVIEW_InsertRow()</code>             | Inserts a new row into the LISTVIEW at the given position.                                  |
| <code>LISTVIEW_IsRowPartiallyVisible()</code> | Returns if a row of the LISTVIEW is partially visible, fully visible or not visible at all. |
| <code>LISTVIEW_OwnerDraw()</code>             | Default function for managing drawing operations of one cell.                               |
| <code>LISTVIEW_RowIsDisabled()</code>         | Returns if a row has been disabled.   |
| <code>LISTVIEW_SetAutoScrollH()</code>        | Enables/disables the automatic use of a horizontal scroll bar.                              |
| <code>LISTVIEW_SetAutoScrollV()</code>        | Enables/disables the automatic use of a vertical scroll bar.                                |
| <code>LISTVIEW_SetBkColor()</code>            | Sets the background color of the given LISTVIEW widget.                                     |
| <code>LISTVIEW_SetColumnWidth()</code>        | Sets the width of the given column.   |
| <code>LISTVIEW_SetCompareFunc()</code>        | Sets the compare function for the given column.   |
| <code>LISTVIEW_SetDefaultBkColor()</code>     | Sets the default background color for new LISTVIEW widgets.                                 |
| <code>LISTVIEW_SetDefaultFont()</code>        | Sets the default font for new LISTVIEW widgets.   |
| <code>LISTVIEW_SetDefaultGridColor()</code>   | Sets the default color of the grid lines for new LISTVIEW widgets.                          |
| <code>LISTVIEW_SetDefaultScrollStepH()</code> | Sets the default scrolling distance for horizontal scrolling.                               |
| <code>LISTVIEW_SetDefaultTextColor()</code>   | Sets the default text color for new LISTVIEW widgets.                                       |
| <code>LISTVIEW_SetFixed()</code>              | Fixes the given number of columns at their horizontal positions.                            |
| <code>LISTVIEW_SetFont()</code>               | Sets the font of the LISTVIEW widget.   |

| Routine                                  | Description   |
|--|---|
| <code>LISTVIEW_SetGridColor()</code>     | Sets the grid color of the LISTVIEW.  |
| <code>LISTVIEW_SetGridVis()</code>       | Sets the visibility flag of the grid lines.   |
| <code>LISTVIEW_SetHeaderHeight()</code>  | Sets the height of the attached HEADER widget.  |
| <code>LISTVIEW_SetItemBitmap()</code>    | Sets a bitmap as background of the given cell.  |
| <code>LISTVIEW_SetItemBkColor()</code>   | Sets the background color of the given cell.  |
| <code>LISTVIEW_SetItemText()</code>      | Sets the text of one cell of the LISTVIEW widget specified by row and column.                           |
| <code>LISTVIEW_SetItemTextColor()</code> | Sets the text color of the given cell.  |
| <code>LISTVIEW_SetLBorder()</code>       | Sets the number of pixels used for the left border within each cell of the LISTVIEW widget.             |
| <code>LISTVIEW_SetOwnerDraw()</code>     | Sets an application defined owner draw function for the widget which is responsible for drawing a cell. |
| <code>LISTVIEW_SetRBorder()</code>       | Sets the number of pixels used for the right border within each cell of the LISTVIEW widget.            |
| <code>LISTVIEW_SetRowHeight()</code>     | Sets a constant row height.   |
| <code>LISTVIEW_SetScrollPos()</code>     | Scrolls the LISTVIEW to a given column and row.   |
| <code>LISTVIEW_SetScrollStepH()</code>   | Sets a distance in pixels for horizontal scrolling.   |
| <code>LISTVIEW_SetSel()</code>           | Sets the current selected row.  |
| <code>LISTVIEW_SetSelCol()</code>        | Sets the current selected column.   |
| <code>LISTVIEW_SetSelUnsorted()</code>   | Sets the current selection in unsorted state.   |
| <code>LISTVIEW_SetSort()</code>          | Sets the column and sorting order to be sorted by.  |
| <code>LISTVIEW_SetTextAlign()</code>     | Sets the alignment for the given column.  |
| <code>LISTVIEW_SetTextColor()</code>     | Sets the text color of the given LISTVIEW widget.   |
| <code>LISTVIEW_SetUserData()</code>      | Sets the extra data of a LISTVIEW widget.   |
| <code>LISTVIEW_SetUserDataRow()</code>   | Sets the user data of the given row.  |
| <code>LISTVIEW_SetWrapMode()</code>      | Sets the wrapping mode which should be used for the cells of the given LISTVIEW widget.                 |

## Defines

| Group of defines                    | Description                                |
|-------------------------------------|--|
| <code>LISTVIEW color indexes</code> | Color indexes used by the LISTVIEW widget. |

## 6.2.17.5.1 Functions

### 6.2.17.5.1.1 LISTVIEW\_AddColumn()

#### Description

Adds a new column to a LISTVIEW widget.

#### Prototype

```
int LISTVIEW_AddColumn(    LISTVIEW_Handle  hObj,
                          int                Width,
                          const char        * s,
                          int                Align);
```

#### Parameters

| Parameter          | Description   |
|--------------------|---|
| <code>hObj</code>  | Handle to a LISTVIEW widget   |
| <code>Width</code> | <code>Width</code> of the new column  |
| <code>s</code>     | Text to be displayed in the HEADER widget   |
| <code>Align</code> | Text alignment mode to set. In case of -1 the default alignment for LISTVIEW widgets is used. List of flags can be found under <i>Text alignment flags</i> on page 252. |

#### Additional information

The `Width`-parameter can be 0. If `Width = 0` the width of the new column will be calculated by the given text and by the default value of the horizontal spacing. You can only add columns to an 'empty' LISTVIEW widget. If it contains 1 or more rows you can not add a new column.

### 6.2.17.5.1.2 LISTVIEW\_AddRow()

#### Description

Adds a new row to a LISTVIEW widget.

#### Prototype

```
int LISTVIEW_AddRow(          LISTVIEW_Handle  hObj,  
                           const GUI_ConstString * ppText);
```

#### Parameters

| Parameter              | Description  |
|------------------------|--|
| <a href="#">hObj</a>   | Handle to a LISTVIEW widget                                |
| <a href="#">ppText</a> | Pointer to array containing the text of the LISTVIEW cells |

#### Additional information

The [ppText](#)-array should contain one item for each column. If it contains less items the remaining cells left blank.

### 6.2.17.5.1.3 LISTVIEW\_Clear()

#### Description

Removes all items from the LISTVIEW.

#### Prototype

```
void LISTVIEW_Clear(LISTVIEW_Handle hObj);
```

#### Parameters

| Parameter            | Description                 |
|----------------------|-----------------------------|
| <a href="#">hObj</a> | Handle to a LISTVIEW widget |



#### 6.2.17.5.1.4 LISTVIEW\_CompareDec()

##### Description

Compare function for comparing 2 integer values.

##### Prototype

```
int LISTVIEW_CompareDec(const void * p0,  
                       const void * p1);
```

##### Parameters

| Parameter          | Description                   |
|--------------------|-------------------------------|
| <a href="#">p0</a> | Void pointer to first value.  |
| <a href="#">p1</a> | Void pointer to second value. |

##### Return value

< 0     if value of cell 0 greater than value of cell 1.  
= 0     if value of cell 0 identical to value of cell 1.  
> 0     if value of cell 0 less than value of cell 1.

##### Additional information

The purpose of this function is to be used by the listviews sorting algorithm if the cell text represents integer values. For details about how to use this function for sorting, refer also to `LISTVIEW_SetCompareFunc()`. The `Sample` folder contains the example `WIDGET_SortedListView.c` which shows how to use the function.

### 6.2.17.5.1.5 LISTVIEW\_CompareText()

#### Description

Function for comparison of 2 strings.

#### Prototype

```
int LISTVIEW_CompareText(const void * p0,  
                        const void * p1);
```

#### Parameters

| Parameter       | Description                  |
|-----------------|------------------------------|
| <code>p0</code> | Void pointer to first text.  |
| <code>p1</code> | Void pointer to second text. |

#### Return value

> 0     if text of cell 0 greater than text of cell 1.  
= 0     if text of cell 0 identical to text of cell 1.  
< 0     if text of cell 0 less than text of cell 1.

#### Additional information

The purpose of this function is to be used by the listviews sorting algorithm. For details about how to use this function for sorting, refer also to `LISTVIEW_SetCompareFunc()`. The `Sample` folder contains the example `WIDGET_SortedListview.c` which shows how to use the function.

### 6.2.17.5.1.6 LISTVIEW\_Create()

#### Note

This function is **deprecated**, `LISTVIEW_CreateEx()` should be used instead.

#### Description

Creates a LISTVIEW widget of a specified size at a specified location.

#### Prototype

```
LISTVIEW_Handle LISTVIEW_Create(int    x0,
                                int    y0,
                                int    xSize,
                                int    ySize,
                                WM_HWIN hParent,
                                int    Id,
                                int    Flags,
                                int    ExFlags);
```

#### Parameters

| Parameter                 | Description  |
|---------------------------|--|
| <code>x0</code>           | Leftmost pixel of the widget (in parent coordinates).  |
| <code>y0</code>           | Topmost pixel of the widget (in parent coordinates).   |
| <code>xSize</code>        | Horizontal size of the widget (in pixels).   |
| <code>ySize</code>        | Vertical size of the widget (in pixels).   |
| <code>hParent</code>      | Handle of the parent window  |
| <code>Id</code>           | <code>Id</code> of the new widget  |
| <code>Flags</code>        | Window create flags. Typically <code>WM_CF_SHOW</code> in order to make the widget visible immediately (refer to <i>Window create flags</i> on page 977 for a list of available parameter values). |
| <code>SpecialFlags</code> | (Reserved for later use)   |

#### Return value

Handle of the created LISTVIEW widget; 0 if the function fails.

### 6.2.17.5.1.7 LISTVIEW\_CreateAttached()

#### Description

Creates a LISTVIEW widget which is attached to an existing window.

#### Prototype

```
LISTVIEW_Handle LISTVIEW_CreateAttached(WM_HWIN hParent,  
                                         int      Id,  
                                         int      SpecialFlags);
```

#### Parameters

| Parameter                    | Description                                   |
|------------------------------|---|
| <a href="#">hObj</a>         | Handle to a LISTVIEW widget                   |
| <a href="#">Id</a>           | <a href="#">Id</a> of the new LISTVIEW widget |
| <a href="#">SpecialFlags</a> | (Not used, reserved for later use)            |

#### Return value

Handle of the created LISTVIEW widget; 0 if the function fails.

#### Additional information

An attached LISTVIEW widget is essentially a child window which will position itself on the parent window and operate accordingly.

### 6.2.17.5.1.8 LISTVIEW\_CreateEx()

#### Description

Creates a LISTVIEW widget of a specified size at a specified location.

#### Prototype

```
LISTVIEW_Handle LISTVIEW_CreateEx(int    x0,
                                   int    y0,
                                   int    xSize,
                                   int    ySize,
                                   WM_HWIN hParent,
                                   int    WinFlags,
                                   int    ExFlags,
                                   int    Id);
```

#### Parameters

| Parameter             | Description  |
|-----------------------|--|
| <code>x0</code>       | Leftmost pixel of the widget (in parent coordinates).  |
| <code>y0</code>       | Topmost pixel of the widget (in parent coordinates).   |
| <code>xSize</code>    | Horizontal size of the widget (in pixels).   |
| <code>ySize</code>    | Vertical size of the widget (in pixels).   |
| <code>hParent</code>  | Handle of parent window. If 0, the new LISTVIEW widget will be a child of the desktop (top-level window).  |
| <code>WinFlags</code> | Window create flags. Typically <code>WM_CF_SHOW</code> in order to make the widget visible immediately (refer to <i>Window create flags</i> on page 977 for a list of available parameter values). |
| <code>ExFlags</code>  | Not used, reserved for future use.   |
| <code>Id</code>       | Window ID of the widget.   |

#### Return value

Handle of the created LISTVIEW widget; 0 if the function fails.

### 6.2.17.5.1.9 LISTVIEW\_CreateIndirect()

#### Description

The prototype of this function is explained at the beginning of this chapter. Details can be found in the description of the function `<WIDGET>_CreateIndirect()` on page 992. The element `Para` of the according `GUI_WIDGET_CREATE_INFO` structure is not used. The element `Flags` is used according to the parameter `ExFlags` of the function `LISTVIEW_CreateEx()`.

### 6.2.17.5.1.10 LISTVIEW\_CreateUser()

#### Description

Prototype explained at the beginning of the chapter as `<WIDGET>_CreateUser()` on page 993. For a detailed description of the parameters the function `LISTVIEW_CreateEx()` can be referred to.

### 6.2.17.5.1.11 LISTVIEW\_DecSel()

#### Description

Decrement the listview selection (moves the selection bar of a specified listview up by one item, if possible).

#### Prototype

```
void LISTVIEW_DecSel(LISTVIEW_Handle hObj);
```

#### Parameters

| Parameter         | Description                 |
|-------------------|-----------------------------|
| <code>hObj</code> | Handle to a LISTVIEW widget |

#### Additional information

Note that the numbering of items always starts from the top with a value of 0; therefore, decrementing the selection will actually move the selection one row up.



### 6.2.17.5.1.12 LISTVIEW\_DeleteAllRows()

#### Description

Deletes all rows from the given LISTVIEW widget.

#### Prototype

```
void LISTVIEW_DeleteAllRows(LISTVIEW_Handle hObj);
```

#### Parameters

| Parameter            | Description                  |
|----------------------|------------------------------|
| <a href="#">hObj</a> | Handle to a LISTVIEW widget. |

### 6.2.17.5.1.13 LISTVIEW\_DeleteColumn()

#### Description

Deletes the specified column of the LISTVIEW widget.

#### Prototype

```
void LISTVIEW_DeleteColumn(LISTVIEW_Handle hObj,  
                           unsigned Index);
```

#### Parameters

| Parameter             | Description                               |
|-----------------------|---|
| <a href="#">hObj</a>  | Handle to a LISTVIEW widget               |
| <a href="#">Index</a> | Zero-based index of column to be deleted. |

#### Additional information

Note that the numbering of items always starts from the left with a value of 0.

#### 6.2.17.5.1.14 LISTVIEW\_DeleteRow()

##### Description

Deletes the specified row of the LISTVIEW widget.

##### Prototype

```
void LISTVIEW_DeleteRow(LISTVIEW_Handle hObj,  
                        unsigned Index);
```

##### Parameters

| Parameter             | Description                            |
|-----------------------|--|
| <a href="#">hObj</a>  | Handle to a LISTVIEW widget            |
| <a href="#">Index</a> | Zero-based index of row to be deleted. |

##### Additional information

Note that the numbering of items always starts from the top with a value of 0.

### 6.2.17.5.1.15 LISTVIEW\_DisableRow()

| Before         |         |             |  | After          |         |             |  |
|----------------|---------|-------------|--|----------------|---------|-------------|--|
| EAN            | Order # | Description |  | EAN            | Order # | Description |  |
| 623499-0010001 | 1       | Item 1      |  | 623499-0010001 | 1       | Item 1      |  |
| 623499-0010002 | 2       | Item 2      |  | 623499-0010002 | 2       | Item 2      |  |
| 623499-0010003 | 3       | Item 3      |  | 623499-0010003 | 3       | Item 3      |  |
| 623499-0010004 | 4       | Item 4      |  | 623499-0010004 | 4       | Item 4      |  |
| 623499-0010005 | 5       | Item 5      |  | 623499-0010005 | 5       | Item 5      |  |

#### Description

The function sets the state of the given row to disabled.

#### Prototype

```
void LISTVIEW_DisableRow(LISTVIEW_Handle hObj,
                        unsigned Row);
```

#### Parameters

| Parameter         | Description                                 |
|-------------------|---|
| <code>hObj</code> | Handle to a LISTVIEW widget.                |
| <code>Row</code>  | Zero-based index of the row to be disabled. |

#### Additional information

When scrolling through a LISTVIEW widget disabled items will be skipped. You can not scroll to a disabled listview item.

### 6.2.17.5.1.16 LISTVIEW\_DisableSort()

#### Description

Disables sorting of the given LISTVIEW widget. After calling this function the content of the LISTVIEW widget will be shown unsorted.

#### Prototype

```
void LISTVIEW_DisableSort(LISTVIEW_Handle hObj);
```

#### Parameters

| Parameter            | Description                 |
|----------------------|-----------------------------|
| <a href="#">hObj</a> | Handle to a LISTVIEW widget |

#### Additional information

For details about how to use sorting in LISTVIEW widgets, refer to `LISTVIEW_SetCompareFunc()` and `LISTVIEW_SetSort()`. The `Sample` folder contains the example `WIDGET_SortedListview.c` which shows how to use the function.

### 6.2.17.5.1.17 LISTVIEW\_EnableCellSelect()

| Before         |         |             |  | After          |         |             |  |
|----------------|---------|-------------|--|----------------|---------|-------------|--|
| EAN            | Order # | Description |  | EAN            | Order # | Description |  |
| 623499-0010001 | 1       | Item 1      |  | 623499-0010001 | 1       | Item 1      |  |
| 623499-0010002 | 2       | Item 2      |  | 623499-0010002 | 2       | Item 2      |  |
| 623499-0010003 | 3       | Item 3      |  | 623499-0010003 | 3       | Item 3      |  |
| 623499-0010004 | 4       | Item 4      |  | 623499-0010004 | 4       | Item 4      |  |
| 623499-0010005 | 5       | Item 5      |  | 623499-0010005 | 5       | Item 5      |  |

#### Description

Enables or disables cell selection mode of the given LISTVIEW widget. If cell selection is enabled it is possible to select a cell via the keys up, down, left and right.

#### Prototype

```
void LISTVIEW_EnableCellSelect(LISTVIEW_Handle hObj,
                               unsigned        OnOff);
```

#### Parameters

| Parameter          | Description                                       |
|--------------------|---|
| <code>hObj</code>  | Handle to a LISTVIEW widget.                      |
| <code>OnOff</code> | 1 to enable and 0 to disable cell selection mode. |

### 6.2.17.5.1.18 LISTVIEW\_EnableMotion()

#### Description

Enables motion support for the given LISTVIEW widget.

#### Prototype

```
void LISTVIEW_EnableMotion(LISTVIEW_Handle hObj,
                           int             Flags);
```

#### Parameters

| Parameter             | Description                |
|-----------------------|----------------------------|
| <a href="#">hObj</a>  | Handle of LISTVIEW widget. |
| <a href="#">Flags</a> | See table below.           |

| Permitted values for parameter <a href="#">Flags</a> |                                    |
|--|------------------------------------|
| 0  | Disables motion support.           |
| LISTVIEW_CF_MOTION_H                                 | Enables horizontal motion support. |
| LISTVIEW_CF_MOTION_V                                 | Enables vertical motion support.   |

#### Additional information

If motion support isn't enabled for the window manager, it will be activated automatically.

Note that motion support cannot be used in conjunction with SCROLLBAR widgets. This means that enabling motion support on one axis will remove a scrollbar attached to the same axis. This does however **not** apply to SCROLLER widgets.

### 6.2.17.5.1.19 LISTVIEW\_EnableRow()

| Before         |         |             |  | After          |         |             |  |
|----------------|---------|-------------|--|----------------|---------|-------------|--|
| EAN            | Order # | Description |  | EAN            | Order # | Description |  |
| 623499-0010001 | 1       | Item 1      |  | 623499-0010001 | 1       | Item 1      |  |
| 623499-0010002 | 2       | Item 2      |  | 623499-0010002 | 2       | Item 2      |  |
| 623499-0010003 | 3       | Item 3      |  | 623499-0010003 | 3       | Item 3      |  |
| 623499-0010004 | 4       | Item 4      |  | 623499-0010004 | 4       | Item 4      |  |
| 623499-0010005 | 5       | Item 5      |  | 623499-0010005 | 5       | Item 5      |  |

#### Description

The function sets the state of the given row to enabled.

#### Prototype

```
void LISTVIEW_EnableRow(LISTVIEW_Handle hObj,
                       unsigned Row);
```

#### Parameters

| Parameter         | Description                                 |
|-------------------|---|
| <code>hObj</code> | Handle to a LISTVIEW widget.                |
| <code>Row</code>  | Zero-based index of the row to be disabled. |

#### Additional information

Refer to `LISTVIEW_DisableRow()`.



### 6.2.17.5.1.20 LISTVIEW\_EnableSort()

#### Description

Enables sorting for the given LISTVIEW widget. After calling this function the content of the listview can be rendered sorted after clicking on the header item of the desired column, by which the LISTVIEW widget should sort its data. Note that this works only after a compare function for the desired column has been set.

#### Prototype

```
void LISTVIEW_EnableSort(LISTVIEW_Handle hObj);
```

#### Parameters

| Parameter            | Description                 |
|----------------------|-----------------------------|
| <a href="#">hObj</a> | Handle to a LISTVIEW widget |

#### Additional information

For details about how to set a compare function, refer to `LISTVIEW_SetCompareFunc()`. The `Sample` folder contains the example `WIDGET_SortedListview.c` which shows how to use the function.

### 6.2.17.5.1.21 LISTVIEW\_GetBkColor()

#### Description

Returns the background color of the given LISTVIEW widget.

#### Prototype

```
GUI_COLOR LISTVIEW_GetBkColor(LISTVIEW_Handle hObj,  
                               unsigned Index);
```

#### Parameters

| Parameter             | Description  |
|-----------------------|--|
| <a href="#">hObj</a>  | Handle to a LISTVIEW widget  |
| <a href="#">Index</a> | Color index. See <i>LISTVIEW color indexes</i> on page 1673 for a full list of permitted values. |

#### Return value

Background color of the given LISTVIEW widget.

### 6.2.17.5.1.22 LISTVIEW\_GetDefaultBkColor()

#### Description

Gets the default background color for new LISTVIEW widgets.

#### Prototype

```
GUI_COLOR LISTVIEW_GetDefaultBkColor(unsigned Index);
```

#### Parameters

| Parameter             | Description  |
|-----------------------|--|
| <a href="#">Index</a> | <a href="#">Index</a> of default background color. See <i>LISTVIEW color indexes</i> on page 1673 for a full list of permitted values. |

#### Return value

Default background color.

### 6.2.17.5.1.23 LISTVIEW\_GetDefaultFont()

#### Description

Gets the default font for new LISTVIEW widgets.

#### Prototype

```
GUI_FONT *LISTVIEW_GetDefaultFont(void);
```

#### Return value

Pointer to the default font.

#### 6.2.17.5.1.24 LISTVIEW\_GetDefaultGridColor()

##### Description

Gets the default color of the grid lines for new LISTVIEW widgets.

##### Prototype

```
GUI_COLOR LISTVIEW_GetDefaultGridColor(void);
```

##### Return value

Default grid color.

### 6.2.17.5.1.25 LISTVIEW\_GetDefaultScrollStepH()

#### Description

Gets the default scrolling distance for horizontal scrolling.

#### Prototype

```
int LISTVIEW_GetDefaultScrollStepH(void);
```

#### Return value

Default scrolling distance.

### 6.2.17.5.1.26 LISTVIEW\_GetDefaultTextColor()

#### Description

Gets the default text color for new LISTVIEW widgets.

#### Prototype

```
GUI_COLOR LISTVIEW_GetDefaultTextColor(unsigned Index);
```

#### Parameters

| Parameter             | Description  |
|-----------------------|--|
| <a href="#">Index</a> | <a href="#">Index</a> of default text color. See <i>LISTVIEW color indexes</i> on page 1673 for a full list of permitted values. |

#### Return value

Default text color.

### 6.2.17.5.1.27 LISTVIEW\_GetFont()

#### Description

Returns a pointer to the font used to display the text of the LISTVIEW widget.

#### Prototype

```
GUI_FONT *LISTVIEW_GetFont(LISTVIEW_Handle hObj);
```

#### Parameters

| Parameter            | Description                 |
|----------------------|-----------------------------|
| <a href="#">hObj</a> | Handle to a LISTVIEW widget |

#### Return value

Pointer to the font used to display the text of the LISTVIEW widget.



### 6.2.17.5.1.28 LISTVIEW\_GetGridColor()

#### Description

Returns the grid color of the LISTVIEW.

#### Prototype

```
GUI_COLOR LISTVIEW_GetGridColor(LISTVIEW_Handle hObj);
```

#### Parameters

| Parameter            | Description                 |
|----------------------|-----------------------------|
| <a href="#">hObj</a> | Handle to a LISTVIEW widget |

#### Return value

Grid color of the LISTVIEW.

### 6.2.17.5.1.29 LISTVIEW\_GetHeader()

#### Description

Returns the handle of the HEADER widget.

#### Prototype

```
HEADER_Handle LISTVIEW_GetHeader(LISTVIEW_Handle hObj);
```

#### Parameters

| Parameter            | Description                 |
|----------------------|-----------------------------|
| <a href="#">hObj</a> | Handle to a LISTVIEW widget |

#### Return value

Handle of the HEADER widget.

#### Additional information

Each LISTVIEW widget contains a HEADER widget to manage the columns. You can use this handle to change the properties of the LISTVIEW-HEADER, for example to change the text color of the HEADER widget.

#### Example

```
LISTVIEW_Handle hListView = LISTVIEW_Create(10, 80, 270, 89, 0, 1234, WM_CF_SHOW, 0);  
HEADER_Handle  hHeader   = LISTVIEW_GetHeader(hListView);  
HEADER_SetTextColor(hHeader, GUI_GREEN);
```

### 6.2.17.5.1.30 LISTVIEW\_GetItemRect()

#### Description

Returns the rectangle of the given LISTVIEW cell by copying the coordinates to the given GUI\_RECT structure.

#### Prototype

```
void LISTVIEW_GetItemRect(LISTVIEW_Handle  hObj,  
                          U32             Col,  
                          U32             Row,  
                          GUI_RECT       * pRect);
```

#### Parameters

| Parameter             | Description  |
|-----------------------|--|
| <a href="#">hObj</a>  | Handle to a LISTVIEW widget                                    |
| <a href="#">Col</a>   | Zero-based index of the cell's column.                         |
| <a href="#">Row</a>   | Zero-based index of the cell's row                             |
| <a href="#">pRect</a> | Pointer to a rectangle to be filled with the item coordinates. |

### 6.2.17.5.1.31 LISTVIEW\_GetItemText()

#### Description

Copies the text of the specified item to the given buffer.

#### Prototype

```
void LISTVIEW_GetItemText(LISTVIEW_Handle hObj,
                          unsigned Column,
                          unsigned Row,
                          char * pBuffer,
                          unsigned MaxSize);
```

#### Parameters

| Parameter            | Description                                      |
|----------------------|--|
| <code>hObj</code>    | Handle to a LISTVIEW widget                      |
| <code>Column</code>  | Zero-based index of the cell's column.           |
| <code>Row</code>     | Zero-based index of the cell's row               |
| <code>pBuffer</code> | Pointer to a buffer to be filled by the routine. |
| <code>MaxSize</code> | Size in bytes of the buffer.                     |

#### Additional information

If the text of the cell does not fit into the buffer, the number of bytes specified by the parameter `MaxSize` will be copied to the buffer.

### 6.2.17.5.1.32 LISTVIEW\_GetItemTextLen()

#### Description

Returns the length in characters of the given text item.

#### Prototype

```
unsigned LISTVIEW_GetItemTextLen(LISTVIEW_Handle hObj,  
                                unsigned         Column,  
                                unsigned         Row);
```

#### Parameters

| Parameter              | Description                            |
|------------------------|--|
| <a href="#">hObj</a>   | Handle to a LISTVIEW widget            |
| <a href="#">Column</a> | Zero-based index of the cell's column. |
| <a href="#">Row</a>    | Zero-based index of the cell's row     |

#### Return value

Length in characters of the given text item.

### 6.2.17.5.1.33 LISTVIEW\_GetItemTextSorted()

#### Description

Copies the text of the specified item to the given buffer. Parameter [Row](#) specifies the index of the sorted LISTVIEW widget.

#### Prototype

```
void LISTVIEW_GetItemTextSorted(LISTVIEW_Handle hObj,
                                unsigned Column,
                                unsigned Row,
                                char * pBuffer,
                                unsigned MaxSize);
```

#### Parameters

| Parameter               | Description                                      |
|-------------------------|--|
| <a href="#">hObj</a>    | Handle to a LISTVIEW widget                      |
| <a href="#">Column</a>  | Zero-based index of the cell's column.           |
| <a href="#">Row</a>     | Zero-based sorted index of the cell's row.       |
| <a href="#">pBuffer</a> | Pointer to a buffer to be filled by the routine. |
| <a href="#">MaxSize</a> | Size in bytes of the buffer.                     |

#### Additional information

If the text of the cell does not fit into the buffer, the number of bytes specified by the parameter [MaxSize](#) will be copied to the buffer.

### 6.2.17.5.1.34 LISTVIEW\_GetLBorder()

#### Description

Returns the size of the left border within a cell of a LISTVIEW. This value can be set with `LISTVIEW_SetLBorder()`.

#### Prototype

```
unsigned LISTVIEW_GetLBorder(LISTVIEW_Handle hObj);
```

#### Parameters

| Parameter         | Description                  |
|-------------------|------------------------------|
| <code>hObj</code> | Handle to a LISTVIEW widget. |

#### Return value

Size of left border.

### 6.2.17.5.1.35 LISTVIEW\_GetNumColumns()

#### Description

Returns the number of columns of the given LISTVIEW widget.

#### Prototype

```
unsigned LISTVIEW_GetNumColumns(LISTVIEW_Handle hObj);
```

#### Parameters

| Parameter            | Description                 |
|----------------------|-----------------------------|
| <a href="#">hObj</a> | Handle to a LISTVIEW widget |

#### Return value

Number of columns of the given LISTVIEW widget.



### 6.2.17.5.1.36 LISTVIEW\_GetNumRows()

#### Description

Returns the number of rows of the given LISTVIEW widget.

#### Prototype

```
unsigned LISTVIEW_GetNumRows(LISTVIEW_Handle hObj);
```

#### Parameters

| Parameter            | Description                 |
|----------------------|-----------------------------|
| <a href="#">hObj</a> | Handle to a LISTVIEW widget |

#### Return value

Number of rows of the given LISTVIEW widget.

### 6.2.17.5.1.37 LISTVIEW\_GetRBorder()

#### Description

Returns the size of the right border within a cell of a LISTVIEW. This value can be set with `LISTVIEW_SetRBorder()`.

#### Prototype

```
unsigned LISTVIEW_GetRBorder(LISTVIEW_Handle hObj);
```

#### Parameters

| Parameter         | Description                  |
|-------------------|------------------------------|
| <code>hObj</code> | Handle to a LISTVIEW widget. |

#### Return value

Size of right border.

### 6.2.17.5.1.38 LISTVIEW\_GetScrollStepH()

#### Description

Returns the currently set horizontal scrolling distance.

#### Prototype

```
int LISTVIEW_GetScrollStepH(LISTVIEW_Handle hObj);
```

#### Parameters

| Parameter            | Description                 |
|----------------------|-----------------------------|
| <a href="#">hObj</a> | Handle to a LISTVIEW widget |

#### Return value

- > 0 Distance in px for horizontal scrolling.
- = 0 Column-wise scrolling is active.
- = -1 Invalid handle.

### 6.2.17.5.1.39 LISTVIEW\_GetSel()

#### Description

Returns the index of the currently selected row in a specified LISTVIEW widget.

#### Prototype

```
int LISTVIEW_GetSel(LISTVIEW_Handle hObj);
```

#### Parameters

| Parameter            | Description                 |
|----------------------|-----------------------------|
| <a href="#">hObj</a> | Handle to a LISTVIEW widget |

#### Return value

Index of the currently selected row.

#### 6.2.17.5.1.40 LISTVIEW\_GetSelCol()

##### Description

Returns the index of the currently selected column.

##### Prototype

```
int LISTVIEW_GetSelCol(LISTVIEW_Handle hObj);
```

##### Parameters

| Parameter            | Description                 |
|----------------------|-----------------------------|
| <a href="#">hObj</a> | Handle to a LISTVIEW widget |

##### Return value

Index of the currently selected column.

### 6.2.17.5.1.41 LISTVIEW\_GetSelUnsorted()

#### Description

Returns the index of the currently selected row in unsorted state.

#### Prototype

```
int LISTVIEW_GetSelUnsorted(LISTVIEW_Handle hObj);
```

#### Parameters

| Parameter            | Description                 |
|----------------------|-----------------------------|
| <a href="#">hObj</a> | Handle to a LISTVIEW widget |

#### Return value

Index of the currently selected row in unsorted state.

#### Additional information

This function returns the actual index of the selected row, whereas the function `LISTVIEW_GetSel()` only returns the index of the sorted row. The actual (unsorted) row index should be used in function calls as row index. The `Sample` folder contains the example `WIDGET_SortedListview.c` which shows how to use the function.

### 6.2.17.5.1.42 LISTVIEW\_GetTextAlign()

#### Description

Returns the currently set text alignment for the given column.

#### Prototype

```
int LISTVIEW_GetTextAlign(LISTVIEW_Handle hObj,  
                          unsigned ColIndex);
```

#### Parameters

| Parameter             | Description                  |
|-----------------------|------------------------------|
| <code>hObj</code>     | Handle to a LISTVIEW widget. |
| <code>ColIndex</code> | Zero-based index of column.  |

#### Return value

- = -1 On error.
- ≠ -1 Text alignment of given column. Refer to *Text alignment flags* on page 252.

### 6.2.17.5.1.43 LISTVIEW\_GetTextColor()

#### Description

Returns the text color of the given LISTVIEW widget.

#### Prototype

```
GUI_COLOR LISTVIEW_GetTextColor(LISTVIEW_Handle hObj,  
                                unsigned Index);
```

#### Parameters

| Parameter             | Description   |
|-----------------------|---|
| <a href="#">hObj</a>  | Handle to a LISTVIEW widget.  |
| <a href="#">Index</a> | <a href="#">Index</a> of color. See <i>LISTVIEW color indexes</i> on page 1673 for a full list of permitted values. |

#### Return value

Text color of the given LISTVIEW widget.



#### 6.2.17.5.1.44 LISTVIEW\_GetUserData()

##### Description

Prototype explained at the beginning of the chapter as `<WIDGET>_GetUserData()` on page 994.

### 6.2.17.5.1.45 LISTVIEW\_GetUserDataRow()

#### Description

Returns the user data of the given row.

#### Prototype

```
U32 LISTVIEW_GetUserDataRow(LISTVIEW_Handle hObj,  
                           unsigned Row);
```

#### Parameters

| Parameter            | Description                  |
|----------------------|------------------------------|
| <a href="#">hObj</a> | Handle to a LISTVIEW widget. |
| <a href="#">Row</a>  | Zero-based index of row.     |

#### Return value

User data of the given row.

#### Additional information

Details on how to set user data for a row can be found in the description of the function `LISTVIEW_SetUserDataRow()`.

### 6.2.17.5.1.46 LISTVIEW\_GetVisRowIndices()

#### Description

Retrieves the index of the first and last visible item. The function also returns the total number of visible items.

#### Prototype

```
int LISTVIEW_GetVisRowIndices(LISTVIEW_Handle hObj,
                             int * pFirst,
                             int * pLast);
```

#### Parameters

| Parameter           | Description  |
|---------------------|--|
| <code>hObj</code>   | Handle to a LISTVIEW widget  |
| <code>pFirst</code> | Pointer to an integer that stores the zero-based index of the first visible row of the LISTVIEW. |
| <code>pLast</code>  | Pointer to an integer that stores the zero-based index of the last visible row of the LISTVIEW.  |

#### Return value

= -1 Error.  
 ≠ -1 Number of visible items.

#### Additional information

This function also takes partially visible rows into account. By using the function `LISTVIEW_IsRowPartiallyVisible()`, it can be checked if a row is only partially visible, fully visible or not visible at all.

### 6.2.17.5.1.47 LISTVIEW\_GetWrapMode()

#### Description

Returns the currently used mode for wrapping text.

#### Prototype

```
GUI_WRAPMODE LISTVIEW_GetWrapMode(LISTVIEW_Handle hObj);
```

#### Parameters

| Parameter            | Description                  |
|----------------------|------------------------------|
| <a href="#">hObj</a> | Handle to a LISTVIEW widget. |

#### Return value

Currently used wrap mode.

#### Additional information

Details on how to use text wrapping can be found in the description of the function `LISTVIEW_SetWrapMode()`.

### 6.2.17.5.1.48 LISTVIEW\_IncSel()

#### Description

Increment the selection of the LISTVIEW widget (moves the selection bar of a specified LISTVIEW down by one item).

#### Prototype

```
void LISTVIEW_IncSel(LISTVIEW_Handle hObj);
```

#### Parameters

| Parameter            | Description                  |
|----------------------|------------------------------|
| <a href="#">hObj</a> | Handle to a LISTVIEW widget. |

### 6.2.17.5.1.49 LISTVIEW\_InsertRow()

#### Description

Inserts a new row into the LISTVIEW at the given position.

#### Prototype

```
int LISTVIEW_InsertRow(    LISTVIEW_Handle  hObj,
                          unsigned         Index,
                          const GUI_ConstString * ppText);
```

#### Parameters

| Parameter           | Description  |
|---------------------|--|
| <code>hObj</code>   | Handle to a LISTVIEW widget.                                       |
| <code>Index</code>  | <code>Index</code> of the new row.                                 |
| <code>ppText</code> | Pointer to a string array containing the cell data of the new row. |

#### Return value

0        if function succeed  
1        if an error occurs.

#### Additional information

The `ppText`-array should contain one item for each column. If it contains less items the remaining cells left blank.

If the given index is  $\geq$  the current number of rows, the function `LISTVIEW_AddRow()` will be used to add the new row.

The `Sample` folder contains the example `WIDGET_SortedListview.c` which shows how to use the function.

### 6.2.17.5.1.50 LISTVIEW\_IsRowPartiallyVisible()

#### Description

Returns if a row of the LISTVIEW is partially visible, fully visible or not visible at all.

#### Prototype

```
int LISTVIEW_IsRowPartiallyVisible(LISTVIEW_Handle hObj,  
                                   unsigned Index);
```

#### Parameters

| Parameter             | Description                                |
|-----------------------|--|
| <a href="#">hObj</a>  | Handle to a LISTVIEW widget                |
| <a href="#">Index</a> | Zero-based index of the row to be checked. |

#### Return value

- 1 Error.
- 0 Row is not visible at all.
- 1 Row is partially visible.
- 2 Row is fully visible.

### 6.2.17.5.1.51 LISTVIEW\_OwnerDraw()

#### Description

Default function for managing drawing operations of one cell.

#### Prototype

```
int LISTVIEW_OwnerDraw(const WIDGET_ITEM_DRAW_INFO * pDrawItemInfo);
```

#### Parameters

| Parameter                  | Description  |
|----------------------------|--|
| <code>pDrawItemInfo</code> | Pointer to a <code>WIDGET_ITEM_DRAW_INFO</code> structure. |

#### Return value

Depends on the command in the `Cmd` element of the `WIDGET_ITEM_DRAW_INFO` structure pointed by `pDrawItemInfo`.

#### Additional information

This function is useful if `LISTVIEW_SetOwnerDraw()` is used. It can be used to retrieve the original size of a data item and/or to draw the text of a data item and should be called for all commands which are not managed by the application defined owner draw function.

The following commands are managed by the default function:

- `WIDGET_ITEM_GET_XSIZE`
- `WIDGET_ITEM_GET_YSIZE`
- `WIDGET_ITEM_DRAW`
- `WIDGET_DRAW_BACKGROUND`



### 6.2.17.5.1.52 LISTVIEW\_RowIsDisabled()

#### Description

Returns if a row has been disabled.

#### Prototype

```
unsigned LISTVIEW_RowIsDisabled(LISTVIEW_Handle hObj,  
                                unsigned Row);
```

#### Parameters

| Parameter         | Description                                |
|-------------------|--|
| <code>hObj</code> | Handle to a LISTVIEW widget.               |
| <code>Row</code>  | Zero-based index of the row to be checked. |

#### Return value

- 0 `Row` is not disabled.
- 1 `Row` is disabled.

#### Additional information

Rows of a LISTVIEW widget can be disabled using `LISTVIEW_DisableRow()` and enabled with `LISTVIEW_EnableRow()`.

### 6.2.17.5.1.53 LISTVIEW\_SetAutoScrollH()

#### Description

Enables/disables the automatic use of a horizontal scroll bar.

#### Prototype

```
void LISTVIEW_SetAutoScrollH(LISTVIEW_Handle hObj,
                             int State);
```

#### Parameters

| Parameter             | Description                  |
|-----------------------|------------------------------|
| <a href="#">hObj</a>  | Handle to a LISTVIEW widget. |
| <a href="#">State</a> | See table below.             |

| Permitted values for parameter <a href="#">OnOff</a> |   |
|--|---|
| 0  | Disable automatic use of a horizontal scroll bar. |
| 1  | Enable automatic use of a horizontal scroll bar.  |

#### Additional information

If enabled the LISTVIEW checks if all columns fit into the widgets area. If not a horizontal scroll bar will be added.

### 6.2.17.5.1.54 LISTVIEW\_SetAutoScrollV()

#### Description

Enables/disables the automatic use of a vertical scroll bar.

#### Prototype

```
void LISTVIEW_SetAutoScrollV(LISTVIEW_Handle hObj,
                             int State);
```

#### Parameters

| Parameter             | Description                  |
|-----------------------|------------------------------|
| <a href="#">hObj</a>  | Handle to a LISTVIEW widget. |
| <a href="#">State</a> | See table below.             |

| Permitted values for parameter <a href="#">OnOff</a> |   |
|--|---|
| 0  | Disable automatic use of a vertical scroll bar. |
| 1  | Enable automatic use of a vertical scroll bar.  |

#### Additional information

If enabled the LISTVIEW checks if all rows fit into the widgets area. If not a vertical scroll bar will be added.

### 6.2.17.5.1.55 LISTVIEW\_SetBkColor()

#### Description

Sets the background color of the given LISTVIEW widget.

#### Prototype

```
void LISTVIEW_SetBkColor(LISTVIEW_Handle hObj,
                        unsigned int    Index,
                        GUI_COLOR       Color);
```

#### Parameters

| Parameter             | Description   |
|-----------------------|---|
| <a href="#">hObj</a>  | Handle to a LISTVIEW widget.  |
| <a href="#">Index</a> | <a href="#">Index</a> for background color. See <i>LISTVIEW color indexes</i> on page 1673 for a full list of permitted values. |
| <a href="#">Color</a> | <a href="#">Color</a> to be set.  |

#### Additional information

To set the background color for a single cell the function `LISTVIEW_SetItemBkColor()` should be used. The `Sample` folder contains the example `WIDGET_SortedListview.c` which shows how to use the function.

### 6.2.17.5.1.56 LISTVIEW\_SetColumnWidth()

#### Description

Sets the width of the given column.

#### Prototype

```
void LISTVIEW_SetColumnWidth(LISTVIEW_Handle hObj,  
                             unsigned int   Index,  
                             int            Width);
```

#### Parameters

| Parameter             | Description                  |
|-----------------------|------------------------------|
| <a href="#">hObj</a>  | Handle to a LISTVIEW widget. |
| <a href="#">Index</a> | Number of column             |
| <a href="#">Width</a> | New width                    |

### 6.2.17.5.1.57 LISTVIEW\_SetCompareFunc()

#### Description

Sets the compare function for the given column. A compare function needs to be set if the LISTVIEW widget should be sorted by the given column.

#### Prototype

```
void LISTVIEW_SetCompareFunc
    (LISTVIEW_Handle hObj,
     unsigned        Column,
     int             (*fpCompare)(const void * p0 , const void * p1 ));
```

#### Parameters

| Parameter              | Description   |
|------------------------|---|
| <code>hObj</code>      | Handle to a LISTVIEW widget.  |
| <code>Column</code>    | Index of the desired column for which the compare function should be set. |
| <code>fpCompare</code> | Function pointer to compare function.                                     |

#### Additional information

If the sorting feature of the listview widget is used, the widget uses a compare function to decide if the content of one cell is greater, equal or less than the content of the other cell.

Per default no compare function is set for the LISTVIEW columns. For each column which should be used for sorting, a compare function needs to be set. The cells of the LISTVIEW widget contain text. But sometimes the text represents data of other types like dates, integers or others. So different compare functions are required for sorting. emWin provides 2 compare functions:

- `LISTVIEW_CompareText()`      Function can be used for comparing cells containing text.
- `LISTVIEW_CompareDec()`      Function can be used for comparing cells which text, where the content represents integer values.

The compare function should return a value  $>0$ , if the content of the second cell is greater than the content of the first cell and  $<0$ , if the content of the second cell is less than the content of the first cell or 0 if equal.

Also user defined compare functions can be used. The prototype of a application-defined function should be defined as follows:

#### Prototype

```
int APPLICATION_Compare(const void * p0,
                       const void * p1);
```

| Parameter       | Description  |
|-----------------|--|
| <code>p0</code> | Pointer to NULL terminated string data of the first cell.  |
| <code>p1</code> | Pointer to NULL terminated string data of the second cell. |

#### Example

```
int APPLICATION_Compare(const void * p0, const void * p1) {
    return strcmp((const char *)p1, (const char *)p0);
}
void SetAppCompareFunc(WM_HWIN hListView, int Column) {
    LISTVIEW_SetCompareFunc(hListView, Column, APPLICATION_Compare);
}
```

The `Sample` folder contains the example `WIDGET_SortedListview.c` which shows how to use the function.

### 6.2.17.5.1.58 LISTVIEW\_SetDefaultBkColor()

#### Description

Sets the default background color for new LISTVIEW widgets.

#### Prototype

```
GUI_COLOR LISTVIEW_SetDefaultBkColor(unsigned Index,  
                                     GUI_COLOR Color);
```

#### Parameters

| Parameter             | Description  |
|-----------------------|--|
| <a href="#">Index</a> | <a href="#">Index</a> of default background color. See <i>LISTVIEW color indexes</i> on page 1673 for a full list of permitted values. |
| <a href="#">Color</a> | <a href="#">Color</a> to be set as default   |

#### Return value

Previous default background color.



### 6.2.17.5.1.59 LISTVIEW\_SetDefaultFont()

#### Description

Sets the default font for new LISTVIEW widgets.

#### Prototype

```
GUI_FONT *LISTVIEW_SetDefaultFont(const GUI_FONT * pFont);
```

#### Parameters

| Parameter          | Description                                    |
|--------------------|--|
| <code>pFont</code> | Pointer to font used for new LISTVIEW widgets. |

#### Return value

Pointer to the previous default font.

### 6.2.17.5.1.60 LISTVIEW\_SetDefaultGridColor()

#### Description

Sets the default color of the grid lines for new LISTVIEW widgets.

#### Prototype

```
GUI_COLOR LISTVIEW_SetDefaultGridColor(GUI_COLOR Color);
```

#### Parameters

| Parameter | Description        |
|-----------|--------------------|
| Color     | New default value. |

#### Return value

Previous default grid color.

### 6.2.17.5.1.61 LISTVIEW\_SetDefaultScrollStepH()

#### Description

Sets the default scrolling distance for horizontal scrolling.

#### Prototype

```
int LISTVIEW_SetDefaultScrollStepH(int Dist);
```

#### Parameters

| Parameter         | Description        |
|-------------------|--------------------|
| <code>Dist</code> | New default value. |

#### Return value

Previous default scrolling distance.

### 6.2.17.5.1.62 LISTVIEW\_SetDefaultTextColor()

#### Description

Sets the default text color for new LISTVIEW widgets.

#### Prototype

```
GUI_COLOR LISTVIEW_SetDefaultTextColor(unsigned Index,  
                                       GUI_COLOR Color);
```

#### Parameters

| Parameter             | Description  |
|-----------------------|--|
| <a href="#">Index</a> | <a href="#">Index</a> of default text color. See <i>LISTVIEW color indexes</i> on page 1673 for a full list of permitted values. |
| <a href="#">Color</a> | <a href="#">Color</a> to be set as default.  |

#### Return value

Previous default text color.

### 6.2.17.5.1.63 LISTVIEW\_SetFixed()

#### Description

Fixes the given number of columns at their horizontal positions.

#### Prototype

```
unsigned LISTVIEW_SetFixed(LISTVIEW_Handle hObj,  
                           unsigned Fixed);
```

#### Parameters

| Parameter          | Description  |
|--------------------|--|
| <code>hObj</code>  | Handle to a LISTVIEW widget.                                 |
| <code>Fixed</code> | Number of columns to be fixed at their horizontal positions. |

#### Return value

Old number of fixed columns.

#### Additional information

Using this function makes sense if one or more columns should remain at their horizontal positions during scrolling operations.

### 6.2.17.5.1.64 LISTVIEW\_SetFont()

#### Description

Sets the font of the LISTVIEW widget.

#### Prototype

```
void LISTVIEW_SetFont(      LISTVIEW_Handle  hObj,  
                          const GUI_FONT    * pFont);
```

#### Parameters

| Parameter          | Description                  |
|--------------------|------------------------------|
| <code>hObj</code>  | Handle to a LISTVIEW widget. |
| <code>pFont</code> | Pointer to the font.         |

### 6.2.17.5.1.65 LISTVIEW\_SetGridVis()

#### Description

Sets the visibility flag of the grid lines. When creating a LISTVIEW the grid lines are disabled per default.

#### Prototype

```
int LISTVIEW_SetGridVis(LISTVIEW_Handle hObj,  
                        int Show);
```

#### Parameters

| Parameter            | Description                            |
|----------------------|--|
| <a href="#">hObj</a> | Handle to a LISTVIEW widget.           |
| <a href="#">Show</a> | Sets the visibility of the grid lines. |

| Permitted values for parameter <a href="#">Show</a> |              |
|---|--------------|
| 0   | Not visible. |
| 1   | Visible      |

#### Return value

Previous value of the visibility flag.

### 6.2.17.5.1.66 LISTVIEW\_SetHeaderHeight()

#### Description

Sets the height of the attached HEADER widget.

#### Prototype

```
void LISTVIEW_SetHeaderHeight(LISTVIEW_Handle hObj,  
                             unsigned HeaderHeight);
```

#### Parameters

| Parameter            | Description                                     |
|----------------------|---|
| <a href="#">hObj</a> | Handle to a LISTVIEW widget.                    |
| <a href="#">Show</a> | Height of the attached HEADER widget to be set. |

#### Additional information

Setting the height to 0 causes the HEADER widget not to be displayed.



### 6.2.17.5.1.67 LISTVIEW\_SetItemBitmap()

| Before   |          |          | After    |          |          |
|----------|----------|----------|----------|----------|----------|
| Column 1 | Column 2 | Column 3 | Column 1 | Column 2 | Column 3 |
| Cell 1   | Cell 2   | Cell 3   | Cell 1   | Cell 2   | Cell 3   |
| Cell 4   | Cell 5   | Cell 6   | Cell 4   | Cell 5   | Cell 6   |
| Cell 7   | Cell 8   | Cell 9   | Cell 7   | Cell 8   | Cell 9   |

#### Description

Sets a bitmap as background of the given cell.

#### Prototype

```
void LISTVIEW_SetItemBitmap(    LISTVIEW_Handle  hObj,
                               unsigned      Column,
                               unsigned      Row,
                               int           xOff,
                               int           yOff,
                               const GUI_BITMAP * pBitmap);
```

#### Parameters

| Parameter               | Description  |
|-------------------------|--|
| <a href="#">hObj</a>    | Handle to a LISTVIEW widget.                             |
| <a href="#">Column</a>  | Number of column.  |
| <a href="#">Row</a>     | Number of row.   |
| <a href="#">xOff</a>    | Offset for the leftmost pixel of the bitmap to be drawn. |
| <a href="#">yOff</a>    | Offset for the topmost pixel of the bitmap to be drawn.  |
| <a href="#">pBitmap</a> | Pointer to the bitmap.                                   |

### 6.2.17.5.1.68 LISTVIEW\_SetItemBkColor()

| Before   |          |          |          | After    |          |          |          |
|----------|----------|----------|----------|----------|----------|----------|----------|
| Col 0    | Col 1    | Col 2    | Col 3    | Col 0    | Col 1    | Col 2    | Col 3    |
| Item 0/0 | Item 1/0 | Item 2/0 | Item 3/0 | Item 0/0 | Item 1/0 | Item 2/0 | Item 3/0 |
| Item 0/1 | Item 1/1 | Item 2/1 | Item 3/1 | Item 0/1 | Item 1/1 | Item 2/1 | Item 3/1 |
| Item 0/2 | Item 1/2 | Item 2/2 | Item 3/2 | Item 0/2 | Item 1/2 | Item 2/2 | Item 3/2 |
| Item 0/3 | Item 1/3 | Item 2/3 | Item 3/3 | Item 0/3 | Item 1/3 | Item 2/3 | Item 3/3 |
|          |          |          |          |          |          |          |          |
|          |          |          |          |          |          |          |          |

#### Description

Sets the background color of the given cell.

#### Prototype

```
void LISTVIEW_SetItemBkColor(LISTVIEW_Handle hObj,
                             unsigned Column,
                             unsigned Row,
                             unsigned Index,
                             GUI_COLOR Color);
```

#### Parameters

| Parameter           | Description   |
|---------------------|---|
| <code>hObj</code>   | Handle to a LISTVIEW widget   |
| <code>Column</code> | Number of columns.  |
| <code>Row</code>    | Number of rows.   |
| <code>Index</code>  | <code>Index</code> of background color. See <i>LISTVIEW color indexes</i> on page 1673 for a full list of permitted values. |
| <code>Color</code>  | <code>Color</code> to be used.  |

#### Additional information

This function overwrites the default background color for the given cell set by `LISTVIEW_SetBkColor()`.

### 6.2.17.5.1.69 LISTVIEW\_SetItemText()

#### Description

Sets the text of one cell of the LISTVIEW widget specified by row and column.

#### Prototype

```
void LISTVIEW_SetItemText(    LISTVIEW_Handle  hObj,
                             unsigned          Column,
                             unsigned          Row,
                             const char       * pText);
```

#### Parameters

| Parameter           | Description                             |
|---------------------|---|
| <code>hObj</code>   | Handle to a LISTVIEW widget             |
| <code>Column</code> | Number of column.                       |
| <code>Row</code>    | Number of row.                          |
| <code>s</code>      | Text to be displayed in the table cell. |

### 6.2.17.5.1.70 LISTVIEW\_SetItemTextColor()

| Before   |          |          |          | After    |          |          |          |
|----------|----------|----------|----------|----------|----------|----------|----------|
| Col 0    | Col 1    | Col 2    | Col 3    | Col 0    | Col 1    | Col 2    | Col 3    |
| Item 0/0 | Item 1/0 | Item 2/0 | Item 3/0 | Item 0/0 | Item 1/0 | Item 2/0 | Item 3/0 |
| Item 0/1 | Item 1/1 | Item 2/1 | Item 3/1 | Item 0/1 | Item 1/1 | Item 2/1 | Item 3/1 |
| Item 0/2 | Item 1/2 | Item 2/2 | Item 3/2 | Item 0/2 | Item 1/2 | Item 2/2 | Item 3/2 |
| Item 0/3 | Item 1/3 | Item 2/3 | Item 3/3 | Item 0/3 | Item 1/3 | Item 2/3 | Item 3/3 |
|          |          |          |          |          |          |          |          |
|          |          |          |          |          |          |          |          |

#### Description

Sets the text color of the given cell.

#### Prototype

```
void LISTVIEW_SetItemTextColor(LISTVIEW_Handle hObj,
                               unsigned        Column,
                               unsigned        Row,
                               unsigned        Index,
                               GUI_COLOR      Color);
```

#### Parameters

| Parameter           | Description   |
|---------------------|---|
| <code>hObj</code>   | Handle to a LISTVIEW widget   |
| <code>Column</code> | Number of column.   |
| <code>Row</code>    | Number of row.  |
| <code>Index</code>  | <code>Index</code> of text color. See <i>LISTVIEW color indexes</i> on page 1673 for a full list of permitted values. |
| <code>Color</code>  | <code>Color</code> to be used.  |

#### Additional information

This function overwrites the default text color for the given cell set by `LISTVIEW_SetTextColor()`.

### 6.2.17.5.1.71 LISTVIEW\_SetItemTextSorted()

#### Description

Sets the text of the given item in a sorted LISTVIEW widget.

#### Prototype

```
void LISTVIEW_SetItemTextSorted(    LISTVIEW_Handle  hObj,
                                   unsigned             Column,
                                   unsigned             Row,
                                   const char           * pText);
```

#### Parameters

| Parameter           | Description                                |
|---------------------|--|
| <code>hObj</code>   | Handle to a LISTVIEW widget                |
| <code>Column</code> | Number of column.                          |
| <code>Row</code>    | Number of row.                             |
| <code>pText</code>  | Pointer to the given NULL terminated text. |

### 6.2.17.5.1.72 LISTVIEW\_SetLBorder()

| Before   |          |          | After    |          |          |
|----------|----------|----------|----------|----------|----------|
| Column 0 | Column 1 | Column 2 | Column 0 | Column 1 | Column 2 |
| Item 0/0 | Item 1/0 | Item 2/0 | Item 0/0 | Item 1/0 | Item 2/0 |
| Item 0/1 | Item 1/1 | Item 2/1 | Item 0/1 | Item 1/1 | Item 2/1 |
| Item 0/2 | Item 1/2 | Item 2/2 | Item 0/2 | Item 1/2 | Item 2/2 |
| Item 0/3 | Item 1/3 | Item 2/3 | Item 0/3 | Item 1/3 | Item 2/3 |

#### Description

Sets the number of pixels used for the left border within each cell of the LISTVIEW widget.

#### Prototype

```
void LISTVIEW_SetLBorder(LISTVIEW_Handle hObj,
                        unsigned        BorderSize);
```

#### Parameters

| Parameter               | Description                  |
|-------------------------|------------------------------|
| <code>hObj</code>       | Handle to a LISTVIEW widget  |
| <code>BorderSize</code> | Number of pixels to be used. |

#### Additional information

Using this function has no effect to the HEADER widget used by the LISTVIEW widget.

### 6.2.17.5.1.73 LISTVIEW\_SetOwnerDraw()

#### Description

Sets an application defined owner draw function for the widget which is responsible for drawing a cell.

#### Prototype

```
void LISTVIEW_SetOwnerDraw(LISTVIEW_Handle hObj,
                           WIDGET_DRAW_ITEM_FUNC * pfOwnerDraw);
```

#### Parameters

| Parameter                | Description                     |
|--------------------------|---------------------------------|
| <code>hObj</code>        | Handle to a LISTVIEW widget     |
| <code>pfOwnerDraw</code> | Pointer to owner draw function. |

#### Supported commands

- WIDGET\_ITEM\_GET\_XSIZE
- WIDGET\_ITEM\_GET\_YSIZE
- WIDGET\_ITEM\_DRAW
- WIDGET\_ITEM\_DRAW\_BACKGROUND

#### Additional information

This function sets a pointer to an application defined function which will be called by the widget when a cell has to be drawn or when the x or y size of a item is needed. It gives you the possibility to draw anything as data item, not just plain text. `pfDrawItem` is a pointer to an application-defined function of type `WIDGET_DRAW_ITEM_FUNC` which is explained at the beginning of the chapter. Also, please refer to `LISTVIEW_OwnerDraw()`.

### 6.2.17.5.1.74 LISTVIEW\_SetRBorder()

| Before   |          |          | After    |          |          |
|----------|----------|----------|----------|----------|----------|
| Column 0 | Column 1 | Column 2 | Column 0 | Column 1 | Column 2 |
| Item 0/0 | Item 1/0 | Item 2/0 | Item 0/0 | Item 1/0 | Item 2/0 |
| Item 0/1 | Item 1/1 | Item 2/1 | Item 0/1 | Item 1/1 | Item 2/1 |
| Item 0/2 | Item 1/2 | Item 2/2 | Item 0/2 | Item 1/2 | Item 2/2 |
| Item 0/3 | Item 1/3 | Item 2/3 | Item 0/3 | Item 1/3 | Item 2/3 |

#### Description

Sets the number of pixels used for the right border within each cell of the LISTVIEW widget.

#### Prototype

```
void LISTVIEW_SetRBorder(LISTVIEW_Handle hObj,
                        unsigned         BorderSize);
```

#### Parameters

| Parameter               | Description                  |
|-------------------------|------------------------------|
| <code>hObj</code>       | Handle to a LISTVIEW widget  |
| <code>BorderSize</code> | Number of pixels to be used. |

#### Additional information

Using this function has no effect to the header widget used by the listview.



### 6.2.17.5.1.75 LISTVIEW\_SetRowHeight()

#### Description

Sets a constant row height.

#### Prototype

```
unsigned LISTVIEW_SetRowHeight(LISTVIEW_Handle hObj,  
                               unsigned RowHeight);
```

#### Parameters

| Parameter              | Description  |
|------------------------|--|
| <code>hObj</code>      | Handle to a LISTVIEW widget  |
| <code>RowHeight</code> | Constant row height to set. In case <code>RowHeight = 0</code> , the height of the current font is used instead. |

#### Return value

Previous value of the row height set by this function.

#### Additional information

Per default the height of the rows depends on the height of the used font.

### 6.2.17.5.1.76 LISTVIEW\_SetScrollPos()

#### Description

Scrolls the LISTVIEW to a given column and row. The specified cell will appear in the upper-left corner of the widget.

#### Prototype

```
void LISTVIEW_SetScrollPos(LISTVIEW_Handle hObj,  
                           unsigned Col,  
                           unsigned Row);
```

#### Parameters

| Parameter         | Description                 |
|-------------------|-----------------------------|
| <code>hObj</code> | Handle to a LISTVIEW widget |
| <code>Col</code>  | Column to scroll to.        |
| <code>Row</code>  | Row to scroll to.           |

### 6.2.17.5.1.77 LISTVIEW\_SetScrollStepH()

#### Description

Sets a distance in pixels for horizontal scrolling. This distance is applied when using arrow keys or clicking the left or right arrows on the scrollbar.

Setting the distance to 0 will enable column-wise scrolling.

#### Prototype

```
int LISTVIEW_SetScrollStepH(LISTVIEW_Handle hObj,  
                             int Dist);
```

#### Parameters

| Parameter         | Description  |
|-------------------|--|
| <code>hObj</code> | Handle to a LISTVIEW widget  |
| <code>Dist</code> | > 0: Distance in px for horizontal scrolling.<br>= 0: Column-wise scrolling. |

#### Return value

≠ -1    Old value.  
= -1    Invalid LISTVIEW handle or invalid `Dist` value.

### 6.2.17.5.1.78 LISTVIEW\_SetSel()

#### Description

Sets the selected row of a specified LISTVIEW widget.

#### Prototype

```
void LISTVIEW_SetSel(LISTVIEW_Handle hObj,  
                    int NewSel);
```

#### Parameters

| Parameter         | Description                 |
|-------------------|-----------------------------|
| <code>hObj</code> | Handle to a LISTVIEW widget |
| <code>Sel</code>  | Row to be selected.         |

#### Additional information

Pass -1 as parameter `Sel` to select no row.

### 6.2.17.5.1.79 LISTVIEW\_SetSelCol()

#### Description

Sets the selected column of the given LISTVIEW widget. Makes sense in combination with LISTVIEW\_EnableCellSelect().

#### Prototype

```
void LISTVIEW_SetSelCol(LISTVIEW_Handle hObj,  
                        int NewCol);
```

#### Parameters

| Parameter              | Description                 |
|------------------------|-----------------------------|
| <a href="#">hObj</a>   | Handle to a LISTVIEW widget |
| <a href="#">NewCol</a> | Column to be selected.      |

### 6.2.17.5.1.80 LISTVIEW\_SetSelUnsorted()

#### Description

Sets the index of the currently selected row in unsorted state.

#### Prototype

```
void LISTVIEW_SetSelUnsorted(LISTVIEW_Handle hObj,  
                             int Sel);
```

#### Parameters

| Parameter            | Description                                   |
|----------------------|---|
| <a href="#">hObj</a> | Handle to a LISTVIEW widget                   |
| <a href="#">Sel</a>  | Zero-based selection index in unsorted state. |

#### Additional information

This function sets the actually index of the selected row, whereas the function `LISTVIEW_SetSel()` sets the index of the sorted row. The actual (unsorted) row index should be used in function calls as row index.

The `Sample` folder contains the example `WIDGET_SortedListview.c` which shows how to use the function.

### 6.2.17.5.1.81 LISTVIEW\_SetSort()

| Before  |       |         |  | After   |       |         |  |
|---------|-------|---------|--|---------|-------|---------|--|
| Name    | Code  | Balance |  | Name    | Code  | Balance |  |
| Name 12 | OEJUV | -233    |  | Name 56 | KASVW | 1944    |  |
| Name 24 | OEFXZ | 97      |  | Name 39 | ENZKY | -2918   |  |
| Name 30 | PSFAD | 3745    |  | Name 30 | PSFAD | 3745    |  |
| Name 29 | FXTLS | -2296   |  | Name 29 | FXTLS | -2296   |  |
| Name 39 | ENZKY | -2918   |  | Name 24 | OEFXZ | 97      |  |
| Name 56 | KASVW | 1944    |  | Name 12 | OEJUV | -233    |  |
|         |       |         |  |         |       |         |  |

#### Description

This function sets the column to be sorted by and the sorting order.

#### Prototype

```
unsigned LISTVIEW_SetSort(LISTVIEW_Handle hObj,
                          unsigned        Column,
                          unsigned        Reverse);
```

#### Parameters

| Parameter            | Description  |
|----------------------|--|
| <code>hObj</code>    | Handle to a LISTVIEW widget  |
| <code>Column</code>  | <code>Column</code> to be sorted by.   |
| <code>Reverse</code> | 0 for normal sorting order (greatest element at the top), 1 for reverse order. |

#### Return value

0 if function was successfully  
1 if not.

#### Additional information

Before calling this function a compare function needs to be set for the desired column. For details about how to set a compare function, refer to `LISTVIEW_SetCompareFunc()`. The `Sample` folder contains the example `WIDGET_SortedListview.c` which shows how to use the function.

### 6.2.17.5.1.82 LISTVIEW\_SetTextAlign()

#### Description

Sets the alignment for the given column.

#### Prototype

```
void LISTVIEW_SetTextAlign(LISTVIEW_Handle hObj,  
                           unsigned int   Index,  
                           int           Align);
```

#### Parameters

| Parameter          | Description   |
|--------------------|---|
| <code>hObj</code>  | Handle to a LISTVIEW widget   |
| <code>Index</code> | Number of column  |
| <code>Align</code> | Text alignment mode to set. List of flags can be found under <i>Text alignment flags</i> on page 252. |



### 6.2.17.5.1.83 LISTVIEW\_SetTextColor()

#### Description

Sets the text color of the given LISTVIEW widget.

#### Prototype

```
void LISTVIEW_SetTextColor(LISTVIEW_Handle hObj,  
                           unsigned int   Index,  
                           GUI_COLOR     Color);
```

#### Parameters

| Parameter             | Description   |
|-----------------------|---|
| <a href="#">hObj</a>  | Handle to a LISTVIEW widget   |
| <a href="#">Index</a> | <a href="#">Index</a> for text color. See <i>LISTVIEW color indexes</i> on page 1673 for a full list of permitted values. |
| <a href="#">Color</a> | <a href="#">Color</a> to be set.  |

#### 6.2.17.5.1.84 LISTVIEW\_SetUserData()

##### Description

Prototype explained at the beginning of the chapter as `<WIDGET>_SetUserData()` on page 995.

### 6.2.17.5.1.85 LISTVIEW\_SetUserDataRow()

#### Description

Sets the user data of the given row.

#### Prototype

```
void LISTVIEW_SetUserDataRow(LISTVIEW_Handle hObj,
                             unsigned       Row,
                             U32           UserData);
```

#### Parameters

| Parameter                | Description   |
|--------------------------|---|
| <a href="#">hObj</a>     | Handle to a LISTVIEW widget                               |
| <a href="#">Row</a>      | <a href="#">Row</a> for which the user data should be set |
| <a href="#">UserData</a> | Value to be associated with the row.                      |

#### Additional information

Sets the 32-bit value associated with the row. Each row has a corresponding 32-bit value intended for use by the application.

### 6.2.17.5.1.86 LISTVIEW\_SetWrapMode()

#### Description

Sets the wrapping mode which should be used for the cells of the given LISTVIEW widget.

#### Prototype

```
void LISTVIEW_SetWrapMode(LISTVIEW_Handle hObj,  
                           GUI_WRAPMODE  WrapMode);
```

#### Parameters

| Parameter                | Description                 |
|--------------------------|-----------------------------|
| <a href="#">hObj</a>     | Handle to a LISTVIEW widget |
| <a href="#">WrapMode</a> | See table below.            |

## 6.2.17.5.2 Defines

### 6.2.17.5.2.1 LISTVIEW color indexes

#### Description

Color indexes to be used by the LISTVIEW widget.

#### Definition

```
#define LISTVIEW_CI_UNSEL      0
#define LISTVIEW_CI_SEL       1
#define LISTVIEW_CI_SELFOCUS  2
#define LISTVIEW_CI_DISABLED  3
```

#### Symbols

| Definition                           | Description                      |
|--------------------------------------|----------------------------------|
| <a href="#">LISTVIEW_CI_UNSEL</a>    | Unselected element.              |
| <a href="#">LISTVIEW_CI_SEL</a>      | Selected element, without focus. |
| <a href="#">LISTVIEW_CI_SELFOCUS</a> | Selected element, with focus.    |
| <a href="#">LISTVIEW_CI_DISABLED</a> | Disabled element.                |

## 6.2.17.6 Example

The `Sample` folder contains the following example which shows how the widget can be used:



- `WIDGET_ListView.c`

Note that several other examples also make use of this widget and may also be helpful to get familiar with the widget.

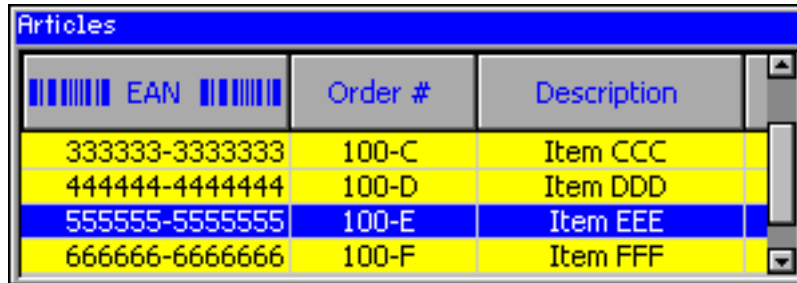
### Screenshot of `WIDGET_ListView.c`



The screenshot shows a ListView widget titled "Articles" containing a table with the following data:

|  EAN  | Order # | Description |
|---|---------|-------------|
| 333333-333333   | 100-C   | Item CCC    |
| 444444-444444   | 100-D   | Item DDD    |
| 555555-555555   | 100-E   | Item EEE    |
| 666666-666666   | 100-F   | Item FFF    |

## 6.2.18 MENU: Menu widget

The MENU widget can be used to create several kinds of MENUs. Each MENU item represents an application command or a submenu. MENUs can be shown horizontally and/or vertically. Menu items can be grouped using separators. Separators are supported for horizontal and vertical MENUs. Selecting a MENU item sends a WM\_MENU message to the owner of the MENU or opens a submenu. If mouse support is enabled the MENU widget reacts on moving the mouse over the items of a MENU widget. The shipment of emWin contains an application example which shows how to use the MENU widget. It can be found under Sample\Application\Reversi.c. The table below shows the appearance of a horizontal MENU widget with a vertical submenu:

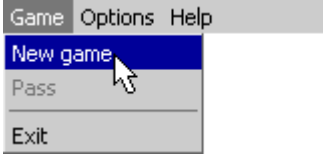
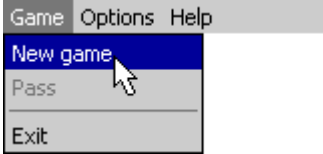
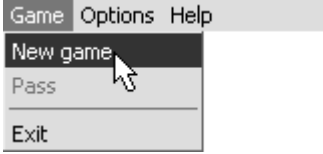
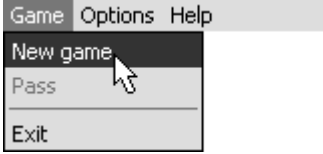
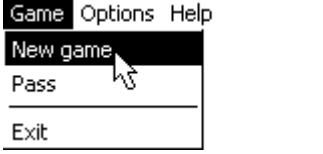
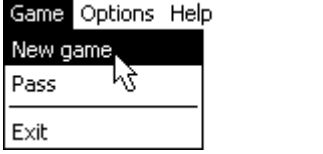
| Description                            | Menu using<br>WIDGET_Effect_3D1L   | Menu using<br>WIDGET_Effect_Simple   |
|--|--|--|
| Color display<br>(8666 mode)           |   |   |
| Monochrome display<br>(16 gray scales) |   |   |
| Black/white display                    |  |  |

**Note**

All MENU-related routines are located in the file(s) MENU\*.c, MENU.h.  
All identifiers are prefixed MENU.

**Skining...**

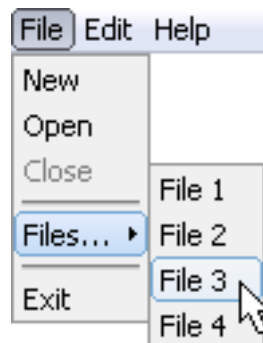

...is available for this widget. The screenshot above shows the widget using the default skin. Details can be found in the chapter *Skining* on page 2509.

## 6.2.18.1 Menu messages

To inform its owner about selecting an item or opening a submenu the MENU widget sends a message of type WM\_MENU to its owner.

### 6.2.18.1.1 WM\_MENU

#### Description

This message is sent to inform the owner of a MENU about selecting an item or opening a submenu. Disabled MENU items will not send this message.

#### Data

The Data.p pointer of the message points to a MENU\_MSG\_DATA structure.

#### Example

The following example shows how to react on a WM\_MENU message:

```
void Callback(WM_MESSAGE * pMsg) {
    MENU_MSG_DATA * pData;
    WM_HWIN hWin = pMsg->hWin;
    switch (pMsg->MsgId) {
    case WM_MENU:
        pData = (MENU_MSG_DATA *)pMsg->Data.p;
        switch (pData->MsgType) {
        case MENU_ON_ITEMACTIVATE:
            _UpdateStatusBar(pData->ItemId);
            break;
        case MENU_ON_INITMENU:
            _OnInitMenu();
            break;
        case MENU_ON_ITEMSELECT:
            switch (pData->ItemId) {
            case ID_MENU_ITEM0:
                ... /* React on selection of menu item 0 */
                break;
            case ID_MENU_ITEM1:
                ... /* React on selection of menu item 1 */
                break;
            case ...
                ...
            }
            break;
        }
        break;
    default:
        MENU_Callback(pMsg);
    }
}
```

## 6.2.18.2 Configuration options

| Type | Macro                 | Default       | Description  |
|------|-----------------------|---------------|--|
| N    | MENU_BKCOLOR0_DEFAULT | GUI_LIGHTGRAY | Background color for enabled and unselected items. |
| N    | MENU_BKCOLOR1_DEFAULT | 0x980000      | Background color for enabled and selected items.   |
| N    | MENU_BKCOLOR2_DEFAULT | GUI_LIGHTGRAY | Background color for disabled items.               |
| N    | MENU_BKCOLOR3_DEFAULT | 0x980000      | Background color for disabled and selected items.  |



| Type | Macro                      | Default            | Description                                      |
|------|----------------------------|--------------------|--|
| N    | MENU_BKCOLOR4_DEFAULT      | 0x7C7C7C           | Background color for active submenu items.       |
| N    | MENU_BORDER_BOTTOM_DEFAULT | 2                  | Border between item text and item bottom.        |
| N    | MENU_BORDER_LEFT_DEFAULT   | 4                  | Border between item text and left edge of item.  |
| N    | MENU_BORDER_RIGHT_DEFAULT  | 4                  | Border between item text and right edge of item. |
| N    | MENU_BORDER_TOP_DEFAULT    | 2                  | Border between item text and item top.           |
| S    | MENU_EFFECT_DEFAULT        | WIDGET_Effect_3D1L | Default effect.                                  |
| S    | MENU_FONT_DEFAULT          | GUI_Font13_1       | Font used.                                       |
| N    | MENU_TEXTCOLOR0_DEFAULT    | GUI_BLACK          | Text color for enabled and unselected items.     |
| N    | MENU_TEXTCOLOR1_DEFAULT    | GUI_WHITE          | Text color for enabled and selected items.       |
| N    | MENU_TEXTCOLOR2_DEFAULT    | 0x7C7C7C           | Text color for disabled items.                   |
| N    | MENU_TEXTCOLOR3_DEFAULT    | GUI_LIGHTGRAY      | Text color for disabled and selected items.      |
| N    | MENU_TEXTCOLOR4_DEFAULT    | GUI_WHITE          | Text color for active submenu items.             |

### 6.2.18.3 Keyboard reaction

The widget reacts to the following keys if it has the input focus:

| Key            | Reaction  |
|----------------|---|
| GUI_KEY_RIGHT  | <ul style="list-style-type: none"> <li>• If the MENU is horizontal, the selection moves one item to the right.</li> <li>• If the MENU is vertical and the current item is a submenu, the submenu opens and the input focus moves to the submenu.</li> <li>• If the MENU is vertical and the current item is not a submenu and the top level MENU is horizontal, the next item of the top level MENU opens and the input focus moves to it.</li> </ul> |
| GUI_KEY_LEFT   | <ul style="list-style-type: none"> <li>• If the MENU is horizontal the selection moves one item to the left.</li> <li>• If the MENU is vertical and the MENU is not the top level MENU, the current MENU closes and the focus moves to the previous MENU. If the previous MENU is horizontal the previous submenu of it opens and the focus moves to the previous submenu.</li> </ul>   |
| GUI_KEY_DOWN   | <ul style="list-style-type: none"> <li>• If the MENU is horizontal and the current MENU item is a submenu this submenu opens.</li> <li>• If the MENU is vertical, the selection moves to the next item.</li> </ul>  |
| GUI_KEY_UP     | <ul style="list-style-type: none"> <li>• If the MENU is vertical, the selection moves to the previous item.</li> </ul>  |
| GUI_KEY_ESCAPE | <ul style="list-style-type: none"> <li>• If the MENU is not the top level MENU the current MENU will be closed and the focus moves to the previous MENU.</li> <li>• If the MENU is the top level MENU, the current MENU item becomes unselected.</li> </ul>   |

| Key           | Reaction   |
|---------------|--|
| GUI_KEY_ENTER | <ul style="list-style-type: none"> <li>If the current MENU item is a submenu, the submenu opens and the focus moves to the submenu.</li> <li>If the current MENU item is not a submenu, all submenus of the top level MENU closes and a MENU_ON_ITEMSELECT message will be sent to the owner of the MENU.</li> </ul> |

## 6.2.18.4 MENU API

The table below lists the available emWin MENU-related routines in alphabetical order. Detailed descriptions of the routines follow.

### Functions

| Routine                                  | Description   |
|--|---|
| <code>MENU_AddItem()</code>              | Adds an item to an existing MENU widget.  |
| <code>MENU_Attach()</code>               | Attaches the given MENU widget at the given position with the given size to a specified WINDOW. |
| <code>MENU_CreateEx()</code>             | Creates a MENU widget.  |
| <code>MENU_CreateIndirect()</code>       | Creates a MENU widget from a resource table entry.  |
| <code>MENU_CreateUser()</code>           | Creates a MENU widget using extra bytes as user data.   |
| <code>MENU_DeleteItem()</code>           | Deletes a given MENU item from a MENU widget.   |
| <code>MENU_DisableItem()</code>          | Disables the given MENU item.   |
| <code>MENU_EnableItem()</code>           | Enables the given MENU item.  |
| <code>MENU_GetBkColor()</code>           | Returns the background color of the widget.   |
| <code>MENU_GetDefaultBkColor()</code>    | Returns the default background color used to draw new MENU items.                               |
| <code>MENU_GetDefaultBorderSize()</code> | Returns the default border size used for new MENU widgets.                                      |
| <code>MENU_GetDefaultEffect()</code>     | Returns the default effect for new MENU widgets.  |
| <code>MENU_GetDefaultFont()</code>       | Returns a pointer to the default font used to display the MENU item text of new MENU widgets.   |
| <code>MENU_GetDefaultTextColor()</code>  | Returns the default text color for new MENU widgets.  |
| <code>MENU_GetFont()</code>              | Returns the font of the widget.   |
| <code>MENU_GetItem()</code>              | Retrieves information about the given MENU item.  |
| <code>MENU_GetItemText()</code>          | Returns the text of the given MENU item.  |
| <code>MENU_GetNumItems()</code>          | Returns the number of items of the given MENU widget.   |
| <code>MENU_GetOwner()</code>             | Returns the owner WINDOW of the given MENU widget.  |
| <code>MENU_GetTextColor()</code>         | Returns the text color of the widget.   |
| <code>MENU_GetUserData()</code>          | Retrieves the data set with <code>MENU_SetUserData()</code> .                                   |
| <code>MENU_InsertItem()</code>           | Inserts a MENU item at the given position.  |
| <code>MENU_Popup()</code>                | Opens the given MENU at the given position.   |
| <code>MENU_SetBkColor()</code>           | Sets the background color of the given MENU widget.   |
| <code>MENU_SetBorderSize()</code>        | Sets the border size of the given MENU widget.  |

| Routine                                  | Description  |
|--|--|
| <code>MENU_SetDefaultBkColor()</code>    | Sets the default background color used to draw new MENU items.                                     |
| <code>MENU_SetDefaultBorderSize()</code> | Sets the default border size used for new MENU widgets.  |
| <code>MENU_SetDefaultEffect()</code>     | Sets the default effect for new MENU widgets.  |
| <code>MENU_SetDefaultFont()</code>       | Sets the pointer to the default font used to display the MENU item text of new MENU widgets.       |
| <code>MENU_SetDefaultTextColor()</code>  | Sets the default text color for new MENU widgets.  |
| <code>MENU_SetFont()</code>              | Sets the pointer to the font used to display the item text of the MENU widget.                     |
| <code>MENU_SetItem()</code>              | Sets the item information for the given MENU item.   |
| <code>MENU_SetOwner()</code>             | Sets the owner WINDOW of the MENU widget that will be informed with <code>WM_MENU</code> messages. |
| <code>MENU_SetSel()</code>               | Sets the selected item of the given MENU widget.   |
| <code>MENU_SetTextColor()</code>         | Sets the text color of the given MENU widget.  |
| <code>MENU_SetUserData()</code>          | Sets the extra data of a MENU widget.  |

### Data structures

| Structure                   | Description   |
|-----------------------------|---|
| <code>MENU_ITEM_DATA</code> | This structure serves as a container to set or retrieve information about MENU items.                     |
| <code>MENU_MSG_DATA</code>  | This structure is used in conjunction with the <code>WM_MENU</code> message, specific to the MENU widget. |

### Defines

| Group of defines                 | Description  |
|----------------------------------|--|
| <code>MENU border indexes</code> | Border indexes used by functions to set the border properties of a MENU widget.                            |
| <code>MENU color indexes</code>  | Color indexes used by the MENU widget.   |
| <code>MENU create flags</code>   | Create flags used by <code>MENU_CreateEx()</code> .  |
| <code>MENU item flags</code>     | Flags used by the <code>MENU_ITEM_DATA</code> structure.   |
| <code>MENU message types</code>  | Types of messages sent via the <code>MENU_MSG_DATA</code> structure with the <code>WM_MENU</code> message. |

## 6.2.18.4.1 Functions

### 6.2.18.4.1.1 MENU\_AddItem()

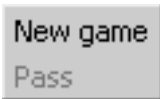
| Before  | After   |
|---|---|
|  |  |

#### Description

This function adds a new item to the end of the given MENU widget.

#### Prototype

```
void MENU_AddItem(    MENU_Handle    hObj,
                    const MENU_ITEM_DATA * pItemData);
```

#### Parameters

| Parameter              | Description   |
|------------------------|---|
| <code>hObj</code>      | Handle of LISTWHEEL widget.   |
| <code>pItemData</code> | Pointer to a MENU_ITEM_DATA structure containing the information of the new item. |

#### Additional information

If using a MENU widget with several submenus the Id of the MENU items should be unique. Different submenus should not contain MENU items with the same IDs. When adding items to a MENU widget and no fixed sizes are used the size of the MENU will be adapted. Refer to *MENU\_ITEM\_DATA* on page 1716.

### 6.2.18.4.1.2 MENU\_Attach()

#### Description

Attaches the given MENU widget at the given position with the given size to a specified WINDOW.

#### Prototype

```
void MENU_Attach(MENU_Handle hObj,
                 WM_HWIN    hDestWin,
                 int         x,
                 int         y,
                 int         xSize,
                 int         ySize,
                 int         Flags);
```

#### Parameters

| Parameter             | Description  |
|-----------------------|--|
| <code>hObj</code>     | Handle of MENU widget.   |
| <code>hDestWin</code> | Handle to the WINDOW to which the MENU widget should be attached.              |
| <code>x</code>        | X position in window coordinates of the MENU widget.                           |
| <code>y</code>        | Y position in window coordinates of the MENU widget.                           |
| <code>ySize</code>    | Fixed Y size of the MENU. For details, refer to <code>MENU_CreateEx()</code> . |
| <code>xSize</code>    | Fixed X size of the MENU. For details, refer to <code>MENU_CreateEx()</code> . |
| <code>Flags</code>    | Reserved for future use  |

#### Additional information

After creating a MENU widget this function can be used to attach the MENU widget to an existing window.

### 6.2.18.4.1.3 MENU\_CreateEx()

#### Description

Creates a MENU widget of a specified size at a specified location.

#### Prototype

```
MENU_Handle MENU_CreateEx(int    x0,
                          int    y0,
                          int    xSize,
                          int    ySize,
                          WM_HWIN hParent,
                          int    WinFlags,
                          int    ExFlags,
                          int    Id);
```

#### Parameters

| Parameter             | Description   |
|-----------------------|---|
| <code>x0</code>       | Leftmost pixel of the widget (in parent coordinates).   |
| <code>y0</code>       | Topmost pixel of the widget (in parent coordinates).  |
| <code>xSize</code>    | Fixed horizontal size of the widget (in pixels). 0 if MENU should handle the <code>xSize</code> .   |
| <code>ySize</code>    | Fixed vertical size of the widget (in pixels). 0 if MENU should handle the <code>ySize</code> .   |
| <code>hParent</code>  | Handle of parent window. If 0, the new widget will be a child of the desktop (top-level window). In some cases it can be useful to create the MENU widget in 'unattached' state and attach it later to an existing window. For this case <code>WM_UNATTACHED</code> can be used as parameter. |
| <code>WinFlags</code> | Window create flags. Typically <code>WM_CF_SHOW</code> in order to make the widget visible immediately (refer to <i>Window create flags</i> on page 977 for a list of available parameter values).  |
| <code>ExFlags</code>  | See <i>MENU create flags</i> on page 1720.  |
| <code>Id</code>       | Window ID of the widget.  |

#### Return value

Handle of the created MENU widget; 0 if the function fails.

#### Additional information

The parameters `xSize` and/or `ySize` specifies if a fixed width and/or height should be used for the MENU widget.

If these parameters are > 0, fixed sizes should be used. If for example the MENU should be attached as a horizontal MENU to the top of a WINDOW it can be necessary to use a fixed X size which covers the whole top of the window. In this case the parameter `xSize` can be used to set a fixed X size of the MENU. When attaching or deleting items of a MENU with a fixed size the size of the widget does not change. If the values are 0, the MENU handles its size itself. That means the size of the MENU depends on the size of the current MENU items of a MENU widget. If items are added or removed the size of the widget will be adapted.

#### 6.2.18.4.1.4 MENU\_CreateIndirect()

##### Description

The prototype of this function is explained at the beginning of this chapter. Details can be found in the description of the function `<WIDGET>_CreateIndirect()` on page 992. The element `Para` of the according `GUI_WIDGET_CREATE_INFO` structure is not used. The element `Flags` is used according to the parameter `ExFlags` of the function `MENU_CreateEx()`.

#### 6.2.18.4.1.5 MENU\_CreateUser()

##### Description

Prototype explained at the beginning of the chapter as `<WIDGET>_CreateUser()` on page 993. For a detailed description of the parameters the function `MENU_CreateEx()` can be referred to.



### 6.2.18.4.1.6 MENU\_DeleteItem()

| Before  | After   |
|---|---|
|  |  |

#### Description

Deletes a given MENU item from a MENU widget.

#### Prototype

```
void MENU_DeleteItem(MENU_Handle hObj,
                    U16          ItemId);
```



#### Parameters

| Parameter           | Description                        |
|---------------------|------------------------------------|
| <code>hObj</code>   | Handle of MENU widget.             |
| <code>ItemId</code> | Id of the MENU item to be deleted. |

#### Additional information

If the item does not exist the function returns immediately. When deleting items from a MENU widget and no fixed sizes are used the window size will be adapted.

### 6.2.18.4.1.7 MENU\_DisableItem()

| Before  | After   |
|---|---|
|  |  |

#### Description

Disables the given MENU item.

#### Prototype

```
void MENU_DisableItem(MENU_Handle hObj,
                     U16          ItemId);
```

#### Parameters

| Parameter           | Description                         |
|---------------------|-------------------------------------|
| <code>hObj</code>   | Handle of MENU widget.              |
| <code>ItemId</code> | Id of the MENU item to be disabled. |

#### Additional information

If a disabled MENU item is selected, the MENU widget does not send the `WM_MENU` message to the owner. A disabled submenu item can not be opened.

### 6.2.18.4.1.8 MENU\_EnableItem()

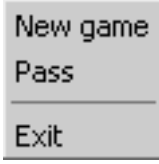
| Before  | After   |
|---|---|
|  |  |

#### Description

Enables the given MENU item.

#### Prototype

```
void MENU_EnableItem(MENU_Handle hObj,
                    U16          ItemId);
```

#### Parameters

| Parameter           | Description                        |
|---------------------|------------------------------------|
| <code>hObj</code>   | Handle of MENU widget.             |
| <code>ItemId</code> | Id of the MENU item to be enabled. |

#### Additional information

For details, refer to `MENU_DisableItem()`.

### 6.2.18.4.1.9 MENU\_GetBkColor()

#### Description

Returns the background color of the widget.

#### Prototype

```
GUI_COLOR MENU_GetBkColor(MENU_Handle hObj,  
                           unsigned    ColorIndex);
```

#### Parameters

| Parameter             | Description   |
|-----------------------|---|
| <a href="#">hObj</a>  | Handle of MENU widget.  |
| <a href="#">Index</a> | See <i>MENU color indexes</i> on page 1719 for a full list of permitted values. |

#### Return value

The background color of the given widget.

#### 6.2.18.4.1.10 MENU\_GetDefaultBkColor()

##### Description

Returns the default background color used to draw new MENU items.

##### Prototype

```
GUI_COLOR MENU_GetDefaultBkColor(unsigned ColorIndex);
```

##### Parameters

| Parameter               | Description   |
|-------------------------|---|
| <code>ColorIndex</code> | See <i>MENU color indexes</i> on page 1719 for a full list of permitted values. |

##### Return value

Default background color used to draw new MENU items.

##### Additional information

For details, refer to `MENU_SetBkColor()`.

### 6.2.18.4.1.11 MENU\_GetDefaultBorderSize()

#### Description

Returns the default border size used for new MENU widgets.

#### Prototype

```
U8 MENU_GetDefaultBorderSize(unsigned BorderIndex);
```

#### Parameters

| Parameter                   | Description  |
|-----------------------------|--|
| <a href="#">BorderIndex</a> | See <i>MENU border indexes</i> on page 1718 for a full list of permitted values. |

#### Return value

Default border size used for new MENU widgets.

#### Additional information

For details, refer to `MENU_SetBorderSize()`.

#### 6.2.18.4.1.12 MENU\_GetDefaultEffect()

##### Description

Returns the default effect for new MENU widgets.

##### Prototype

```
WIDGET_EFFECT *MENU_GetDefaultEffect(void);
```

##### Return value

The result of the function is a pointer to a WIDGET\_EFFECT structure.

##### Additional information

For more information, refer to WIDGET\_SetDefaultEffect().

### 6.2.18.4.1.13 MENU\_GetDefaultFont()

#### Description

Returns a pointer to the default font used to display the MENU item text of new MENU widgets.

#### Prototype

```
GUI_FONT *MENU_GetDefaultFont(void);
```

#### Return value

Pointer to the default font used to display the MENU item text of new MENU widgets.



#### 6.2.18.4.1.14 MENU\_GetDefaultTextColor()

##### Description

Returns the default text color for new MENU widgets.

##### Prototype

```
GUI_COLOR MENU_GetDefaultTextColor(unsigned ColorIndex);
```

##### Parameters

| Parameter               | Description   |
|-------------------------|---|
| <code>ColorIndex</code> | See <i>MENU color indexes</i> on page 1719 for a full list of permitted values. |

##### Return value

Default text color for new MENU widgets.

##### Additional information

For details, refer to `MENU_SetDefaultTextColor()`.

### 6.2.18.4.1.15 MENU\_GetFont()

#### Description

Returns the font of the widget.

#### Prototype

```
GUI_FONT *MENU_GetFont(MENU_Handle hObj);
```

#### Parameters

| Parameter            | Description            |
|----------------------|------------------------|
| <a href="#">hObj</a> | Handle of MENU widget. |

#### Return value

Pointer to the font of the given widget.

### 6.2.18.4.1.16 MENU\_GetItem()

#### Description

Retrieves information about the given MENU item.

#### Prototype

```
void MENU_GetItem(MENU_Handle    hObj,
                  U16            ItemId,
                  MENU_ITEM_DATA * pItemData);
```

#### Parameters

| Parameter              | Description   |
|------------------------|---|
| <code>hObj</code>      | Handle of MENU widget.  |
| <code>ItemId</code>    | Id of the requested MENU item.                                      |
| <code>pItemData</code> | Pointer to a MENU_ITEM_DATA structure to be filled by the function. |

#### Additional information

If using a MENU widget with several submenus the handle of the widget needs to be the handle of the menu/submenu containing the requested item or the handle of a higher menu/submenu.

The function sets the element `pText` of the MENU\_ITEM\_DATA structure to 0. To retrieve the MENU item text the function `MENU_GetItemText()` should be used. Refer to the beginning of the MENU chapter for details about the MENU\_ITEM\_DATA data structure.

### 6.2.18.4.1.17 MENU\_GetItemText()

#### Description

Returns the text of the given MENU item.

#### Prototype

```
void MENU_GetItemText(MENU_Handle  hObj,  
                     U16          ItemId,  
                     char          * pBuffer,  
                     unsigned      BufferSize);
```

#### Parameters

| Parameter                  | Description                              |
|----------------------------|--|
| <a href="#">hObj</a>       | Handle of MENU widget.                   |
| <a href="#">ItemId</a>     | Id of the requested MENU item.           |
| <a href="#">pBuffer</a>    | Buffer to be filled by the function.     |
| <a href="#">BufferSize</a> | Maximum number of bytes to be retrieved. |

#### 6.2.18.4.1.18 MENU\_GetNumItems()

##### Description

Returns the number of items of the given MENU widget.

##### Prototype

```
unsigned MENU_GetNumItems(MENU_Handle hObj);
```

##### Parameters

| Parameter            | Description            |
|----------------------|------------------------|
| <a href="#">hObj</a> | Handle of MENU widget. |

##### Return value

Number of items of the given MENU widget.

### 6.2.18.4.1.19 MENU\_GetOwner()

#### Description

Returns the owner WINDOW of the given MENU widget.

#### Prototype

```
WM_HWIN MENU_GetOwner(MENU_Handle hObj);
```

#### Parameters

| Parameter            | Description            |
|----------------------|------------------------|
| <a href="#">hObj</a> | Handle of MENU widget. |

#### Return value

Owner WINDOW of the given MENU widget.

#### 6.2.18.4.1.20 MENU\_GetTextColor()

##### Description

Returns the text color of the widget.

##### Prototype

```
GUI_COLOR MENU_GetTextColor(MENU_Handle hObj,  
                             unsigned    ColorIndex);
```

##### Parameters

| Parameter             | Description   |
|-----------------------|---|
| <a href="#">hObj</a>  | Handle of MENU widget.  |
| <a href="#">Index</a> | See <i>MENU color indexes</i> on page 1719 for a full list of permitted values. |

##### Return value

The text color of the given widget.

#### 6.2.18.4.1.21 MENU\_GetUserData()

##### **Description**

Prototype explained at the beginning of the chapter as `<WIDGET>_GetUserData()` on page 994.

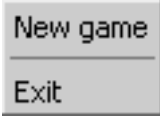
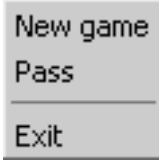

### 6.2.18.4.1.22 MENU\_InsertItem()

| Before  | After   |
|---|---|
|  |  |

#### Description

Inserts a MENU item at the given position.

#### Prototype

```
void MENU_InsertItem(    MENU_Handle    hObj,
                       U16                ItemId,
                       const MENU_ITEM_DATA * pItemData);
```

#### Parameters

| Parameter              | Description   |
|------------------------|---|
| <code>hObj</code>      | Handle of MENU widget.  |
| <code>ItemId</code>    | Id of the MENU item the new item should be inserted before.                       |
| <code>pItemData</code> | Pointer to a MENU_ITEM_DATA structure containing the information of the new item. |

### 6.2.18.4.1.23 MENU\_Popup()

#### Description

Opens the given MENU at the given position. After selecting a MENU item or after touching the display outside the MENU the popup MENU will be closed.

#### Prototype

```
void MENU_Popup(MENU_Handle hObj,
                WM_HWIN    hDestWin,
                int         x,
                int         y,
                int         xSize,
                int         ySize,
                int         Flags);
```

#### Parameters

| Parameter             | Description  |
|-----------------------|--|
| <code>hObj</code>     | Handle of MENU widget.   |
| <code>hDestWin</code> | Handle to the window to which the MENU should be attached.                     |
| <code>x</code>        | X position in window coordinates of the MENU widget.                           |
| <code>y</code>        | Y position in window coordinates of the MENU widget.                           |
| <code>xSize</code>    | Fixed X size of the MENU. For details, refer to <code>MENU_CreateEx()</code> . |
| <code>ySize</code>    | Fixed Y size of the MENU. For details, refer to <code>MENU_CreateEx()</code> . |
| <code>Flags</code>    | Reserved for future use  |

#### Additional information

After selecting a MENU item or after touching the display outside the popup MENU the MENU will be closed. Note that the MENU will not be deleted automatically. The `Sample` folder contains the example `WIDGET_PopupMenu.c` which shows how to use the function.

#### 6.2.18.4.1.24 MENU\_SetBkColor()

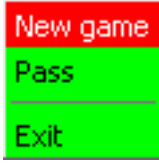
| Before  | After   |
|---|---|
|  |  |

#### Description

Sets the background color of the given MENU widget.

#### Prototype

```
void MENU_SetBkColor(MENU_Handle hObj,
                    unsigned   ColorIndex,
                    GUI_COLOR   Color);
```

#### Parameters

| Parameter               | Description   |
|-------------------------|---|
| <code>hObj</code>       | Handle of MENU widget.  |
| <code>ColorIndex</code> | See <i>MENU color indexes</i> on page 1719 for a full list of permitted values. |
| <code>Color</code>      | <code>Color</code> to be used.  |

### 6.2.18.4.1.25 MENU\_SetBorderSize()



The following code is executed between the screenshots above:

```
MENU_SetBorderSize(hMenuGame, MENU_BI_LEFT, 20);
```



The following code is executed between the screenshots above:

```
MENU_SetBorderSize(hMenu, MENU_BI_LEFT, 10);
MENU_SetBorderSize(hMenu, MENU_BI_RIGHT, 10);
```

## Description

Sets the border size of the given MENU widget.

## Prototype

```
void MENU_SetBorderSize(MENU_Handle hObj,
                        unsigned      BorderIndex,
                        U8            BorderSize);
```

## Parameters

| Parameter                   | Description  |
|-----------------------------|--|
| <a href="#">hObj</a>        | Handle of MENU widget.   |
| <a href="#">BorderIndex</a> | See <i>MENU border indexes</i> on page 1718 for a full list of permitted values. |
| <a href="#">BorderSize</a>  | Size to be used.   |

#### 6.2.18.4.1.26 MENU\_SetDefaultBkColor()

##### Description

Sets the default background color used to draw new MENU items.

##### Prototype

```
void MENU_SetDefaultBkColor(unsigned ColorIndex,  
                             GUI_COLOR Color);
```

##### Parameters

| Parameter               | Description   |
|-------------------------|---|
| <code>ColorIndex</code> | See <i>MENU color indexes</i> on page 1719 for a full list of permitted values. |
| <code>Color</code>      | <code>Color</code> to be used.  |

##### Additional information

For details, refer to `MENU_SetBkColor()`.

### 6.2.18.4.1.27 MENU\_SetDefaultBorderSize()

#### Description

Sets the default border size used for new MENU widgets.

#### Prototype

```
void MENU_SetDefaultBorderSize(unsigned BorderIndex,  
                               U8      BorderSize);
```

#### Parameters

| Parameter                   | Description  |
|-----------------------------|--|
| <a href="#">BorderIndex</a> | See <i>MENU border indexes</i> on page 1718 for a full list of permitted values. |
| <a href="#">BorderSize</a>  | Border size to be used.  |

#### Additional information

For details, refer to `MENU_SetBorderSize()`.

#### 6.2.18.4.1.28 MENU\_SetDefaultEffect()

##### Description

Sets the default effect for new MENU widgets.

##### Prototype

```
void MENU_SetDefaultEffect(const WIDGET_EFFECT * pEffect);
```

##### Parameters

| Parameter            | Description                           |
|----------------------|---------------------------------------|
| <code>pEffect</code> | Pointer to a WIDGET_EFFECT structure. |

##### Additional information

For more information, refer to `WIDGET_SetDefaultEffect()`.

#### 6.2.18.4.1.29 MENU\_SetDefaultFont()

##### Description

Sets the pointer to the default font used to display the MENU item text of new MENU widgets.

##### Prototype

```
void MENU_SetDefaultFont(const GUI_FONT * pFont);
```

##### Parameters

| Parameter          | Description  |
|--------------------|--|
| <code>pFont</code> | Pointer to the <code>GUI_FONT</code> structure to be used. |

##### Additional information

For details, refer to `MENU_SetFont()`.



### 6.2.18.4.1.30 MENU\_SetDefaultTextColor()

#### Description

Sets the default text color for new MENU widgets.

#### Prototype

```
void MENU_SetDefaultTextColor(unsigned ColorIndex,  
                             GUI_COLOR Color);
```



#### Parameters

| Parameter               | Description   |
|-------------------------|---|
| <code>ColorIndex</code> | See <i>MENU color indexes</i> on page 1719 for a full list of permitted values. |
| <code>Color</code>      | <code>Color</code> to be used   |

#### Additional information

For details, refer to `MENU_SetTextColor()`.

### 6.2.18.4.1.31 MENU\_SetFont()

| Before  | After  |
|---|--|
|  |  |

#### Description

Sets the pointer to the font used to display the item text of the MENU widget.

#### Prototype

```
void MENU_SetFont(      MENU_Handle  hObj,
                      const GUI_FONT * pFont);
```

#### Parameters

| Parameter          | Description  |
|--------------------|--|
| <code>hObj</code>  | Handle of MENU widget.                                     |
| <code>pFont</code> | Pointer to the <code>GUI_FONT</code> structure to be used. |

### 6.2.18.4.1.32 MENU\_SetItem()

| Before  | After  |
|---|--|
|  |  |

#### Description

Sets the item information for the given MENU item.

#### Prototype

```
void MENU_SetItem(    MENU_Handle    hObj,
                    U16             ItemId,
                    const MENU_ITEM_DATA * pItemData);
```

#### Parameters

| Parameter              | Description   |
|------------------------|---|
| <code>hObj</code>      | Handle of MENU widget.  |
| <code>ItemId</code>    | Id of the MENU item to be changed.                                    |
| <code>pItemData</code> | Pointer to a MENU_ITEM_DATA structure containing the new information. |

### 6.2.18.4.1.33 MENU\_SetOwner()

#### Description

Sets the owner WINDOW of the MENU widget that will be informed with WM\_MENU messages.

#### Prototype

```
void MENU_SetOwner(MENU_Handle hObj,  
                  WM_HWIN      hOwner);
```

#### Parameters

| Parameter           | Description  |
|---------------------|--|
| <code>hObj</code>   | Handle of MENU widget.   |
| <code>hOwner</code> | Handle of the owner WINDOW which should receive the WM_MENU messages of the MENU widget. |

#### Additional information

If no owner is set the parent WINDOW of the MENU widget will receive WM\_MENU messages. In case the WM\_MENU messages are not intended to be sent to the parent WINDOW, this function can be used to set another recipient for the messages.

### 6.2.18.4.1.34 MENU\_SetSel()

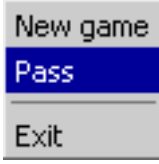
| Before   | After  |
|--|--|
|  <p>A screenshot of a menu with three items: 'New game', 'Pass', and 'Exit'. The 'New game' item is highlighted with a blue background.</p> |  <p>A screenshot of a menu with three items: 'New game', 'Pass', and 'Exit'. The 'Pass' item is highlighted with a blue background.</p> |

#### Description

Sets the selected item of the given MENU widget.

#### Prototype

```
int MENU_SetSel(MENU_Handle hObj,
               int Sel);
```

#### Parameters

| Parameter         | Description                                   |
|-------------------|---|
| <code>hObj</code> | Handle of MENU widget.                        |
| <code>Sel</code>  | Zero-based index of MENU item to be selected. |



#### Return value

The function returns the zero based index of the previous selected MENU item.

#### Additional information

A value <0 for parameter `Sel` deselects the MENU items.

### 6.2.18.4.1.35 MENU\_SetTextColor()

| Before  | After   |
|---|---|
|  |  |

#### Description

Sets the text color of the given MENU widget.

#### Prototype

```
void MENU_SetTextColor(MENU_Handle hObj,
                      unsigned   ColorIndex,
                      GUI_COLOR   Color);
```

#### Parameters

| Parameter               | Description   |
|-------------------------|---|
| <code>hObj</code>       | Handle of MENU widget.  |
| <code>ColorIndex</code> | See <i>MENU color indexes</i> on page 1719 for a full list of permitted values. |
| <code>Color</code>      | <code>Color</code> to be used.  |

#### 6.2.18.4.1.36 MENU\_SetUserData()

##### Description

Prototype explained at the beginning of the chapter as `<WIDGET>_SetUserData()` on page 995.

## 6.2.18.4.2 Data structures

### 6.2.18.4.2.1 MENU\_ITEM\_DATA

#### Description

This structure serves as a container to set or retrieve information about MENU items.

#### Type definition

```
typedef struct {
    const char * pText;
    U16          Id;
    U16          Flags;
    MENU_Handle  hSubmenu;
} MENU_ITEM_DATA;
```

#### Structure members

| Member                   | Description   |
|--------------------------|---|
| <a href="#">pText</a>    | MENU item text.   |
| <a href="#">Id</a>       | <a href="#">Id</a> of the MENU item.  |
| <a href="#">Flags</a>    | See <i>MENU item flags</i> on page 1721.  |
| <a href="#">hSubmenu</a> | If the item represents a submenu this element contains the handle of the submenu. |



### 6.2.18.4.2.2 MENU\_MSG\_DATA

#### Description

This structure is used in conjunction with the WM\_MENU message, specific to the MENU widget. The `Data.p` pointer of the message points to a MENU\_MSG\_DATA structure.

#### Type definition

```
typedef struct {  
    U16  MsgType;  
    U16  ItemId;  
} MENU_MSG_DATA;
```

#### Structure members

| Member                  | Description                                 |
|-------------------------|---|
| <a href="#">MsgType</a> | See <i>MENU message types</i> on page 1722. |
| <a href="#">ItemId</a>  | Id of MENU item.                            |

### 6.2.18.4.3 Defines

#### 6.2.18.4.3.1 MENU border indexes

##### Description

Border indexes used by functions to set the border properties of a MENU widget.

##### Definition

```
#define MENU_BI_LEFT      0
#define MENU_BI_RIGHT    1
#define MENU_BI_TOP      2
#define MENU_BI_BOTTOM   3
```

##### Symbols

| Definition                     | Description                                      |
|--------------------------------|--|
| <a href="#">MENU_BI_LEFT</a>   | Border between item text and left edge of item.  |
| <a href="#">MENU_BI_RIGHT</a>  | Border between item text and right edge of item. |
| <a href="#">MENU_BI_TOP</a>    | Border between item text and item top.           |
| <a href="#">MENU_BI_BOTTOM</a> | Border between item text and item bottom.        |

### 6.2.18.4.3.2 MENU color indexes

#### Description

Color indexes used by the MENU widget.

#### Definition

```
#define MENU_CI_ENABLED          0
#define MENU_CI_SELECTED        1
#define MENU_CI_DISABLED        2
#define MENU_CI_DISABLED_SEL    3
#define MENU_CI_ACTIVE_SUBMENU  4
```

#### Symbols

| Definition                              | Description                                   |
|---|---|
| <a href="#">MENU_CI_ENABLED</a>         | Color of enabled and not selected MENU items. |
| <a href="#">MENU_CI_SELECTED</a>        | Color of enabled and selected MENU items.     |
| <a href="#">MENU_CI_DISABLED</a>        | Color of disabled MENU items.                 |
| <a href="#">MENU_CI_DISABLED_SEL</a>    | Color of disabled and selected MENU items.    |
| <a href="#">MENU_CI_ACTIVE_SUB-MENU</a> | Color of active submenu items.                |

### 6.2.18.4.3.3 MENU create flags

#### Description

Create flags used when creating a MENU widget. These flags are used for the [ExFlags](#) parameter of `MENU_CreateEx()`.

#### Definition

```
#define MENU_CF_HORIZONTAL    (0 << 0)
#define MENU_CF_VERTICAL     (1 << 0)
```

#### Symbols

| Definition                         | Description                |
|------------------------------------|----------------------------|
| <a href="#">MENU_CF_HORIZONTAL</a> | Creates a horizontal MENU. |
| <a href="#">MENU_CF_VERTICAL</a>   | Creates a vertical MENU.   |

#### 6.2.18.4.3.4 MENU item flags

##### Description

Flags used by the `MENU_ITEM_DATA` structure.

##### Definition

```
#define MENU_IF_DISABLED      (1 << 0)
#define MENU_IF_SEPARATOR    (1 << 1)
```

##### Symbols

| Definition                     | Description                         |
|--------------------------------|-------------------------------------|
| <code>MENU_IF_DISABLED</code>  | Indicates that item is disabled.    |
| <code>MENU_IF_SEPARATOR</code> | Indicates that item is a separator. |

### 6.2.18.4.3.5 MENU message types

#### Description

Types of messages sent with the `MsgType` parameter of the `MENU_MSG_DATA` structure. A pointer to this structure is sent via the `Data.p` pointer of a `WM_MENU` message.

#### Definition

```
#define MENU_ON_ITEMSELECT      0
#define MENU_ON_INITMENU      1
#define MENU_ON_ITEMACTIVATE   6
#define MENU_ON_ITEMPRESSED    7
```

#### Symbols

| Definition                        | Description  |
|-----------------------------------|--|
| <code>MENU_ON_ITEMSELECT</code>   | This message is sent to the owner of a MENU immediately after a MENU item is selected. The <code>ItemId</code> element of the <code>MENU_MSG_DATA</code> structure contains the Id of the pressed MENU item. |
| <code>MENU_ON_INITMENU</code>     | This message is sent to the owner of MENU immediately before the MENU opens. This enables the application to modify the MENU before it is shown.   |
| <code>MENU_ON_ITEMACTIVATE</code> | The owner window of a MENU will receive this message after a MENU item has been highlighted. The message is not sent after highlighting a submenu.   |
| <code>MENU_ON_ITEMPRESSED</code>  | After pressing a MENU item this message will be sent to the owner window of the widget. It will be sent also for disabled MENU items.  |

## 6.2.18.5 Example

The `sample` folder contains the sample `WIDGET_Menu.c` which shows how the widget can be used. Note that several other examples also make use of this widget and may also be helpful to get familiar with the widget.

### Screenshot of `WIDGET_Menu.c`

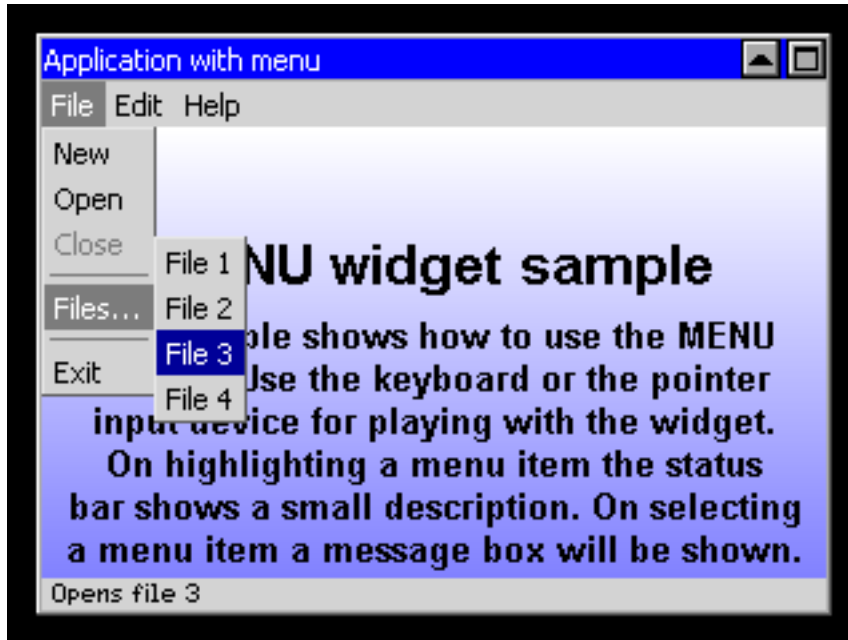



## 6.2.19 MULTIEDIT: Multi line text widget

The MULTIEDIT widget enables you to edit text with multiple lines. You can use it as a simple text editor or to display static text. The widget supports scrolling with and without scroll bars.

### Note

All MULTIEDIT-related routines are in the file(s) MULTIEDIT\*.c, MULTIEDIT.h. All identifiers are prefixed MULTIEDIT.

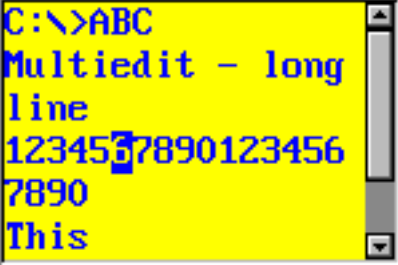
The table below shows the appearance of the MULTIEDIT widget:

| Description   | Frame window   |
|---|--|
| Edit mode,<br>automatic horizontal scroll bar,<br>non wrapping mode,<br>insert mode   |    |
| Edit mode,<br>automatic vertical scroll bar,<br>word wrapping mode,<br>overwrite mode |   |
| Read only mode,<br>word wrapping mode   |  |

### 6.2.19.1 Configuration options

| Type | Macro                           | Default      | Description                      |
|------|---------------------------------|--------------|----------------------------------|
| S    | MULTIEDIT_FONT_DEFAULT          | GUI_Font13_1 | Font used.                       |
| N    | MULTIEDIT_BKCOLOR0_DEFAULT      | GUI_WHITE    | Background color.                |
| N    | MULTIEDIT_BKCOLOR1_DEFAULT      | 0xC0C0C0     | Background color read only mode. |
| N    | MULTIEDIT_TEXTCOLOR0_DEFAULT    | GUI_BLACK    | Text color.                      |
| N    | MULTIEDIT_TEXTCOLOR1_DEFAULT    | GUI_BLACK    | Text color read only mode.       |
| N    | MULTIEDIT_CURSORCOLORBK_DEFAULT | GUI_BLACK    | Background cursor color.         |
| N    | MULTIEDIT_CURSORCOLORFG_DEFAULT | GUI_WHITE    | Foreground cursor color.         |



| Type | Macro                     | Default                              | Description                                     |
|------|---------------------------|--------------------------------------|---|
| N    | MULTIEDIT_ALIGN_DEFAULT   | GUI_TA_LEFT<br>  GUI_TA_V-<br>CENTER | Foreground cursor color.                        |
| N    | MULTIEDIT_HBORDER_DEFAULT | 1                                    | Horizontal border between widget edge and text. |

## 6.2.19.2 Predefined IDs

The following symbols define IDs which may be used to make MULTIEDIT widgets distinguishable from creation.

```
#define GUI_ID_MULTIEDIT0    0x190
#define GUI_ID_MULTIEDIT1    0x191
#define GUI_ID_MULTIEDIT2    0x192
#define GUI_ID_MULTIEDIT3    0x193
#define GUI_ID_MULTIEDIT4    0x194
#define GUI_ID_MULTIEDIT5    0x195
#define GUI_ID_MULTIEDIT6    0x196
#define GUI_ID_MULTIEDIT7    0x197
#define GUI_ID_MULTIEDIT8    0x198
#define GUI_ID_MULTIEDIT9    0x199
```

## 6.2.19.3 Notification codes

The following events are sent from the widget to its parent window as part of a WM\_NOTIFY\_PARENT message:

| Message                        | Description   |
|--------------------------------|---|
| WM_NOTIFICATION_CLICKED        | Widget has been clicked.  |
| WM_NOTIFICATION_RELEASED       | Widget has been released.   |
| WM_NOTIFICATION_MOVED_OUT      | Widget has been clicked and pointer has been moved out of the widget without releasing. |
| WM_NOTIFICATION_SCROLL_CHANGED | The scroll position of the optional scroll bar has been changed.                        |
| WM_NOTIFICATION_VALUE_CHANGED  | The text of the widget has been changed.  |

## 6.2.19.4 Keyboard reaction

The widget reacts to the following keys if it has the input focus:

| Key               | Reaction   |
|-------------------|--|
| GUI_KEY_UP        | Moves the cursor one line up.  |
| GUI_KEY_DOWN      | Moves the cursor one line down.  |
| GUI_KEY_RIGHT     | Moves the cursor one character to the right.   |
| GUI_KEY_LEFT      | Moves the cursor one character to the left.  |
| GUI_KEY_END       | Moves the cursor to the end of the current row.  |
| GUI_KEY_HOME      | Moves the cursor to the begin of the current row.  |
| GUI_KEY_BACKSPACE | If the widget works in read/write mode this key deletes the character before the cursor.   |
| GUI_KEY_DELETE    | If the widget works in read/write mode this key deletes the character below the cursor.  |
| GUI_KEY_INSERT    | Toggles between insert and overwrite mode.   |
| GUI_KEY_ENTER     | If the widget works in read/write mode this key inserts a new line (\n) at the current position. If the widget works in read only mode the cursor will be moved to the beginning of the next line. |
| GUI_KEY_PGUP      | Scrolls the MULTIEDIT page wise up.  |
| GUI_KEY_PGDOWN    | Scrolls the MULTIEDIT page wise down.  |

## 6.2.19.5 MULTIEDIT API

The table below lists the available emWin MULTIEDIT-related routines in alphabetical order. Detailed descriptions of the routines follow.

### Functions

| Routine  | Description  |
|--|--|
| <code>MULTIEDIT_AddKey()</code>                | Adds user input to a specified MULTIEDIT widget.                                     |
| <code>MULTIEDIT_AddText()</code>               | Adds the given text at the current cursor position.                                  |
| <code>MULTIEDIT_Create()</code>                | Creates a MULTIEDIT widget. (Obsolete)   |
| <code>MULTIEDIT_CreateEx()</code>              | Creates a MULTIEDIT widget.  |
| <code>MULTIEDIT_CreateIndirect()</code>        | Creates a MULTIEDIT widget from a resource table entry.                              |
| <code>MULTIEDIT_CreateUser()</code>            | Creates a MULTIEDIT widget using extra bytes as user data.                           |
| <code>MULTIEDIT_EnableBlink()</code>           | Enables/disables a blinking cursor.  |
| <code>MULTIEDIT_EnableMotion()</code>          | Enables motion scrolling for the MULTIEDIT widget.                                   |
| <code>MULTIEDIT_GetBkColor()</code>            | Returns the background color of the widget.  |
| <code>MULTIEDIT_GetCursorCharPos()</code>      | Returns the number of the character at the cursor position.                          |
| <code>MULTIEDIT_GetCursorPixelPos()</code>     | Returns the pixel position of the cursor in window coordinates.                      |
| <code>MULTIEDIT_GetDefaultAlign()</code>       | Returns the default text alignment of new MULTIEDIT widgets.                         |
| <code>MULTIEDIT_GetDefaultBkColor()</code>     | Returns the default background color for new MULTIEDIT widgets.                      |
| <code>MULTIEDIT_GetDefaultCursorColor()</code> | Returns the default foreground or background cursor color for new MULTIEDIT widgets. |
| <code>MULTIEDIT_GetDefaultFont()</code>        | Returns the default font for new MULTIEDIT widgets.                                  |
| <code>MULTIEDIT_GetDefaultHBorder()</code>     | Returns the default horizontal border for new MULTIEDIT widgets.                     |
| <code>MULTIEDIT_GetDefaultTextColor()</code>   | Returns the default text color for new MULTIEDIT widgets.                            |
| <code>MULTIEDIT_GetFont()</code>               | Returns the font of the widget.  |
| <code>MULTIEDIT_GetNumChars()</code>           | Returns the number of characters of the MULTIEDIT widget.                            |
| <code>MULTIEDIT_GetPrompt()</code>             | Returns the current prompt text.   |
| <code>MULTIEDIT_GetText()</code>               | Returns the current text.  |
| <code>MULTIEDIT_GetTextColor()</code>          | Returns the text color of the widget.  |
| <code>MULTIEDIT_GetTextFromLine()</code>       | Returns the text of a given line from a given start character.                       |
| <code>MULTIEDIT_GetTextFromPos()</code>        | Returns the text from a start and end point.   |
| <code>MULTIEDIT_GetTextSize()</code>           | Returns the buffer size used to store the current text (and prompt).                 |
| <code>MULTIEDIT_GetUserData()</code>           | Retrieves the data set with <code>MULTIEDIT_SetUserData()</code> .                   |

| Routine  | Description  |
|--|--|
| <code>MULTIEDIT_SetAutoScrollH()</code>        | Enables/disables the automatic use of a horizontal scroll bar.   |
| <code>MULTIEDIT_SetAutoScrollV()</code>        | Enables/disables the automatic use of a vertical scroll bar.   |
| <code>MULTIEDIT_SetBkColor()</code>            | Sets the background color of the given MULTIEDIT widget.   |
| <code>MULTIEDIT_SetBufferSize()</code>         | Sets the maximum number of bytes used by text and prompt.  |
| <code>MULTIEDIT_SetCursorCharPos()</code>      | This function sets the cursor to the given position where x is the character in a line and y is line.                    |
| <code>MULTIEDIT_SetCursorColor()</code>        | Sets the background or foreground cursor color of the given MULTIEDIT widget.  |
| <code>MULTIEDIT_SetCursorOffset()</code>       | Sets the cursor position to the given character.   |
| <code>MULTIEDIT_SetCursorPixelPos()</code>     | This function sets the cursor to the given position, where x and y are the coordinates in pixels relative to the widget. |
| <code>MULTIEDIT_SetDefaultAlign()</code>       | Sets the default text alignment for new MULTIEDIT widgets.   |
| <code>MULTIEDIT_SetDefaultBkColor()</code>     | Sets the default background color for new MULTIEDIT widgets.   |
| <code>MULTIEDIT_SetDefaultCursorColor()</code> | Sets the default cursor color for new MULTIEDIT widgets.   |
| <code>MULTIEDIT_SetDefaultFont()</code>        | Sets the default font for new MULTIEDIT widgets.   |
| <code>MULTIEDIT_SetDefaultHBorder()</code>     | Sets the default horizontal border for new MULTIEDIT widgets.  |
| <code>MULTIEDIT_SetDefaultTextColor()</code>   | Sets the default text color for new MULTIEDIT widgets.   |
| <code>MULTIEDIT_SetFocusable()</code>          | Sets the focusability of the given MULTIEDIT widget.   |
| <code>MULTIEDIT_SetFont()</code>               | Sets the font.   |
| <code>MULTIEDIT_SetHBorder()</code>            | Sets the size of the horizontal border.  |
| <code>MULTIEDIT_SetInsertMode()</code>         | Enables/disables the insert mode.  |
| <code>MULTIEDIT_SetInvertCursor()</code>       | Enables/disables the inversion mode of cursor.   |
| <code>MULTIEDIT_SetMaxNumChars()</code>        | Sets the maximum number of characters used by text and prompt.   |
| <code>MULTIEDIT_SetPasswordMode()</code>       | Enables/disables the password mode.  |
| <code>MULTIEDIT_SetPrompt()</code>             | Sets the prompt text.  |
| <code>MULTIEDIT_SetReadOnly()</code>           | Enables/disables the read only mode.   |
| <code>MULTIEDIT_SetText()</code>               | Sets the text.   |
| <code>MULTIEDIT_SetTextAlign()</code>          | Sets the text alignment.   |
| <code>MULTIEDIT_SetTextColor()</code>          | Sets the text color.   |
| <code>MULTIEDIT_SetUserData()</code>           | Sets the extra data of a MULTIEDIT widget.   |
| <code>MULTIEDIT_SetWrapChar()</code>           |  |
| <code>MULTIEDIT_SetWrapNone()</code>           | Enables the non wrapping mode.   |
| <code>MULTIEDIT_SetWrapWord()</code>           | Enables the word wrapping mode.  |
| <code>MULTIEDIT_ShowCursor()</code>            | This function enables or disables the cursor of the MULTIEDIT widget.  |

## Defines

| Group of defines                            | Description  |
|---|--|
| <code>MULTIEDIT color indexes</code>        | Color indexes used by the MULTIEDIT widget.              |
| <code>MULTIEDIT cursor color indexes</code> | Cursor color indexes used by the MULTIEDIT widget.       |
| <code>MULTIEDIT create flags</code>         | Create flags used by <code>MULTIEDIT_CreateEx()</code> . |

## 6.2.19.5.1 Functions

### 6.2.19.5.1.1 MULTIEDIT\_AddKey()

#### Description

Adds user input to a specified MULTIEDIT widget.

#### Prototype

```
int MULTIEDIT_AddKey(MULTIEDIT_HANDLE hObj,  
                    U16 Key);
```

#### Parameters

| Parameter            | Description                 |
|----------------------|-----------------------------|
| <a href="#">hObj</a> | Handle of MULTIEDIT widget. |
| <a href="#">Key</a>  | Character to be added.      |

#### Return value

1 if [Key](#) has been consumed.  
0 if [Key](#) was not handled.

#### Additional information

The specified character is added to the user input of the MULTIEDIT widget. If the maximum count of characters has been reached, another character will not be added.

### 6.2.19.5.1.2 MULTIEDIT\_AddText()

#### Description

Adds the given text at the current cursor position.

#### Prototype

```
int MULTIEDIT_AddText(      MULTIEDIT_HANDLE  hObj,  
                          const char        * s);
```

#### Parameters

| Parameter         | Description                                    |
|-------------------|--|
| <code>hObj</code> | Handle of MULTIEDIT widget.                    |
| <code>s</code>    | Pointer to a NULL terminated text to be added. |

#### Additional information

If the number of characters exceeds the limit set with the function `MULTIEDIT_SetMaxNumChars()` the function will add only the characters of the text which fit into the widget respecting the limit.

If the the function `MULTIEDIT_SetMaxNumChars()` has not been called the `MULTIEDIT` widget increases its buffer automatically to hold the complete text.

### 6.2.19.5.1.3 MULTIEDIT\_Create()

#### Note

This function is **deprecated**, `MULTIEDIT_CreateEx()` should be used instead.

#### Description

Creates a `MULTIEDIT` widget of a specified size at a specified location.

#### Prototype

```
MULTIEDIT_HANDLE MULTIEDIT_Create(
    int         x0,
    int         y0,
    int         xSize,
    int         ySize,
    WM_HWIN    hParent,
    int         Id,
    int         Flags,
    int         ExFlags,
    const char * pText,
    int         MaxLen);
```

#### Parameters

| Parameter            | Description  |
|----------------------|--|
| <code>x0</code>      | Leftmost pixel of the <code>MULTIEDIT</code> widget (in parent coordinates).   |
| <code>y0</code>      | Topmost pixel of the <code>MULTIEDIT</code> widget (in parent coordinates).  |
| <code>xSize</code>   | Horizontal size of the <code>MULTIEDIT</code> widget (in pixels).  |
| <code>ySize</code>   | Vertical size of the <code>MULTIEDIT</code> widget (in pixels).  |
| <code>hParent</code> | Parent window of the <code>MULTIEDIT</code> widget.  |
| <code>Id</code>      | ID of the <code>MULTIEDIT</code> widget.   |
| <code>Flags</code>   | Window create flags. Typically <code>WM_CF_SHOW</code> in order to make the widget visible immediately (refer to <i>Window create flags</i> on page 977 in the chapter <i>The Window Manager (WM)</i> on page 798 for a list of available parameter values). |
| <code>ExFlags</code> | See <i>MULTIEDIT create flags</i> on page 1789.  |
| <code>pText</code>   | Text to be used.   |
| <code>MaxLen</code>  | Maximum number of bytes for text and prompt.   |
| <code>s</code>       | Pointer to a <code>NULL</code> terminated text to be added.  |

#### Return value

Handle of the created `MULTIEDIT` widget; 0 if the function fails.



### 6.2.19.5.1.4 MULTIEDIT\_CreateEx()

#### Description

Creates a MULTIEDIT widget of a specified size at a specified location.

#### Prototype

```
MULTIEDIT_HANDLE MULTIEDIT_CreateEx(
    int         x0,
    int         y0,
    int         xSize,
    int         ySize,
    WM_HWIN    hParent,
    int         WinFlags,
    int         ExFlags,
    int         Id,
    int         BufferSize,
    const char  * pText);
```

#### Parameters

| Parameter               | Description  |
|-------------------------|--|
| <code>x0</code>         | Leftmost pixel of the widget (in parent coordinates).  |
| <code>y0</code>         | Topmost pixel of the widget (in parent coordinates).   |
| <code>xSize</code>      | Horizontal size of the widget (in pixels).   |
| <code>ySize</code>      | Vertical size of the widget (in pixels).   |
| <code>hParent</code>    | Handle of parent window. If 0, the new MULTIEDIT widget will be a child of the desktop (top-level window).   |
| <code>WinFlags</code>   | Window create flags. Typically <code>WM_CF_SHOW</code> in order to make the widget visible immediately (refer to <i>Window create flags</i> on page 977 for a list of available parameter values). |
| <code>ExFlags</code>    | See <i>MULTIEDIT create flags</i> on page 1789.  |
| <code>Id</code>         | Window ID of the widget.   |
| <code>BufferSize</code> | Initial text buffer size of the widget. Use <code>MULTIEDIT_SetMaxNumChars()</code> to set the maximum number of characters.   |
| <code>pText</code>      | Text to be used.   |

#### Return value

Handle of the created MULTIEDIT widget; 0 if the function fails.

#### Additional information

If the text set for the MULTIEDIT widget exceeds the number of bytes allocated at creation (`BufferSize`) the widget increases the buffer automatically. To avoid this the user can call `MULTIEDIT_SetMaxNumChars()`.

### 6.2.19.5.1.5 MULTIEDIT\_CreateIndirect()

#### Description

The prototype of this function is explained at the beginning of this chapter. Details can be found in the description of the function `<WIDGET>_CreateIndirect()` on page 992. The element `Para` of the according `GUI_WIDGET_CREATE_INFO` structure is used according to the parameter `BufferSize` of the function `MULTIEDIT_CreateEx()`. The element `Flags` is used according to the parameter `ExFlags` of the function `MULTIEDIT_CreateEx()`.

### 6.2.19.5.1.6 MULTIEDIT\_CreateUser()

#### Description

Prototype explained at the beginning of the chapter as `<WIDGET>_CreateUser()` on page 993. For a detailed description of the parameters the function `MULTIEDIT_CreateEx()` can be referred to.

### 6.2.19.5.1.7 MULTIEDIT\_EnableBlink()

#### Description

Enables/disables a blinking cursor.

#### Prototype

```
void MULTIEDIT_EnableBlink(MULTIEDIT_HANDLE hObj,  
                           int              Period,  
                           int              OnOff);
```

#### Parameters

| Parameter           | Description                             |
|---------------------|---|
| <code>hObj</code>   | Handle of MULTIEDIT widget.             |
| <code>Period</code> | Blinking period                         |
| <code>OnOff</code>  | 1 enables blinking, 0 disables blinking |

#### Additional information

This function calls `GUI_X_GetTime()`.

### 6.2.19.5.1.8 MULTIEDIT\_EnableMotion()

#### Description

Enables motion scrolling for the MULTIEDIT widget.

#### Prototype

```
void MULTIEDIT_EnableMotion(MULTIEDIT_HANDLE hObj,
                           int Flags);
```

#### Parameters

| Parameter             | Description                 |
|-----------------------|-----------------------------|
| <a href="#">hObj</a>  | Handle of MULTIEDIT widget. |
| <a href="#">Flags</a> | See table below.            |

| Permitted values for parameter <a href="#">Flags</a> |                                    |
|--|------------------------------------|
| 0  | Disables motion support.           |
| MULTIEDIT_CF_MOTION_H                                | Enables horizontal motion support. |
| MULTIEDIT_CF_MOTION_V                                | Enables vertical motion support.   |

#### Additional information

If motion support isn't enabled for the window manager, it will be activated automatically.

Note that motion support cannot be used in conjunction with scrollbars. This means that enabling motion support on one axis will remove a scrollbar attached to the same axis.

### 6.2.19.5.1.9 MULTIEDIT\_GetBkColor()

#### Description

Returns the background color of the widget.

#### Prototype

```
GUI_COLOR MULTIEDIT_GetBkColor(MULTIEDIT_HANDLE hObj,  
                               unsigned          Index);
```

#### Parameters

| Parameter             | Description  |
|-----------------------|--|
| <a href="#">hObj</a>  | Handle of MULTIEDIT widget.  |
| <a href="#">Index</a> | See <i>MULTIEDIT color indexes</i> on page 1787 for a full list of permitted values. |

#### Additional information

This function calls `GUI_X_GetTime()`.

### 6.2.19.5.1.10 MULTIEDIT\_GetCursorCharPos()

#### Description

Returns the number of the character at the cursor position.

#### Prototype

```
int MULTIEDIT_GetCursorCharPos(MULTIEDIT_HANDLE hObj);
```

#### Parameters

| Parameter            | Description                 |
|----------------------|-----------------------------|
| <a href="#">hObj</a> | Handle of MULTIEDIT widget. |

#### Return value

Number of the character at the cursor position.

#### Additional information

The widget returns the character position if it has the focus or not. This means the cursor position is also returned, if the cursor is currently not visible in the widget.

### 6.2.19.5.1.11 MULTIEDIT\_GetCursorPixelPos()

#### Description

Returns the pixel position of the cursor in window coordinates.

#### Prototype

```
void MULTIEDIT_GetCursorPixelPos(MULTIEDIT_HANDLE hObj,
                                int * pxPos,
                                int * pyPos);
```

#### Parameters

| Parameter          | Description   |
|--------------------|---|
| <code>hObj</code>  | Handle of MULTIEDIT widget.   |
| <code>pxPos</code> | Pointer to integer variable for the X-position in window coordinates. |
| <code>pyPos</code> | Pointer to integer variable for the Y-position in window coordinates. |

#### Additional information

The widget returns the pixel position if it has the focus or not. This means the cursor position is also returned, if the cursor is currently not visible in the widget.



### 6.2.19.5.1.12 MULTIEDIT\_GetDefaultAlign()

#### Description

Returns the default text alignment of new MULTIEDIT widgets.

#### Prototype

```
int MULTIEDIT_GetDefaultAlign(void);
```

#### Return value

Default text alignment of new MULTIEDIT widgets.

### 6.2.19.5.1.13 MULTIEDIT\_GetDefaultBkColor()

#### Description

Returns the default background color for new MULTIEDIT widgets.

#### Prototype

```
GUI_COLOR MULTIEDIT_GetDefaultBkColor(unsigned Index);
```

#### Parameters

| Parameter             | Description  |
|-----------------------|--|
| <a href="#">Index</a> | See <i>MULTIEDIT color indexes</i> on page 1787 for a full list of permitted values. |

#### Return value

Default background color for new MULTIEDIT widgets.

#### 6.2.19.5.1.14 MULTIEDIT\_GetDefaultCursorColor()

##### Description

Returns the default foreground or background cursor color for new MULTIEDIT widgets.

##### Prototype

```
GUI_COLOR MULTIEDIT_GetDefaultCursorColor(unsigned Index);
```

##### Parameters

| Parameter             | Description   |
|-----------------------|---|
| <a href="#">Index</a> | See <i>MULTIEDIT cursor color indexes</i> on page 1788 for a full list of permitted values. |

##### Return value

Default foreground or background cursor color for new MULTIEDIT widgets.

### 6.2.19.5.1.15 MULTIEDIT\_GetDefaultFont()

#### Description

Returns the default font for new MULTIEDIT widgets.

#### Prototype

```
GUI_FONT *MULTIEDIT_GetDefaultFont(void);
```

#### Return value

Default font for new MULTIEDIT widgets.

### 6.2.19.5.1.16 MULTIEDIT\_GetDefaultHBorder()

#### Description

Returns the default horizontal border for new MULTIEDIT widgets.

#### Prototype

```
unsigned MULTIEDIT_GetDefaultHBorder(void);
```

#### Return value

Default horizontal border for new MULTIEDIT widgets.

### 6.2.19.5.1.17 MULTIEDIT\_GetDefaultTextColor()

#### Description

Returns the default text color for new MULTIEDIT widgets.

#### Prototype

```
GUI_COLOR MULTIEDIT_GetDefaultTextColor(unsigned Index);
```

#### Parameters

| Parameter             | Description  |
|-----------------------|--|
| <a href="#">Index</a> | See <i>MULTIEDIT color indexes</i> on page 1787 for a full list of permitted values. |

#### Return value

Default text color for new MULTIEDIT widgets.

### 6.2.19.5.1.18 MULTIEDIT\_GetFont()

#### Description

Returns the font of the widget.

#### Prototype

```
GUI_FONT *MULTIEDIT_GetFont(MULTIEDIT_HANDLE hObj);
```

#### Parameters

| Parameter            | Description                 |
|----------------------|-----------------------------|
| <a href="#">hObj</a> | Handle of MULTIEDIT widget. |

#### Return value

Pointer to the font of the given widget.

### 6.2.19.5.1.19 MULTIEDIT\_GetNumChars()

#### Description

Returns the number of characters of the MULTIEDIT widget.

#### Prototype

```
int MULTIEDIT_GetNumChars(MULTIEDIT_HANDLE hObj);
```

#### Parameters

| Parameter            | Description                 |
|----------------------|-----------------------------|
| <a href="#">hObj</a> | Handle of MULTIEDIT widget. |

#### Return value

Number of characters present in the specified MULTIEDIT widget.



### 6.2.19.5.1.20 MULTIEDIT\_GetPrompt()

#### Description

Returns the current prompt text.

#### Prototype

```
void MULTIEDIT_GetPrompt (MULTIEDIT_HANDLE hObj,  
                          char * sDest,  
                          int MaxLen);
```

#### Parameters

| Parameter              | Description   |
|------------------------|---|
| <a href="#">hObj</a>   | Handle of MULTIEDIT widget.                                     |
| <a href="#">sDest</a>  | Buffer for the prompt text to be returned.                      |
| <a href="#">MaxLen</a> | Maximum number of bytes to be copied to <a href="#">sDest</a> . |

#### Additional information

The function copies the current prompt text to the buffer given by [sDest](#). The maximum number of bytes copied to the buffer is given by [MaxLen](#).

### 6.2.19.5.1.21 MULTIEDIT\_GetText()

#### Description

Returns the current text.

#### Prototype

```
void MULTIEDIT_GetText (MULTIEDIT_HANDLE  hObj ,  
                        char                * sDest ,  
                        int                 MaxLen );
```

#### Parameters

| Parameter              | Description   |
|------------------------|---|
| <a href="#">hObj</a>   | Handle of MULTIEDIT widget.                                     |
| <a href="#">sDest</a>  | Buffer for the text to be returned.                             |
| <a href="#">MaxLen</a> | Maximum number of bytes to be copied to <a href="#">sDest</a> . |

#### Additional information

The function copies the current text to the buffer given by [sDest](#). The maximum number of bytes copied to the buffer is given by [MaxLen](#).

### 6.2.19.5.1.22 MULTIEDIT\_GetTextColor()

#### Description

Returns the text color of the widget.

#### Prototype

```
GUI_COLOR MULTIEDIT_GetTextColor(MULTIEDIT_HANDLE hObj,  
                                unsigned          Index);
```

#### Parameters

| Parameter             | Description  |
|-----------------------|--|
| <a href="#">hObj</a>  | Handle of MULTIEDIT widget.  |
| <a href="#">Index</a> | See <i>MULTIEDIT color indexes</i> on page 1787 for a full list of permitted values. |

#### Return value

The text color of the given widget.

### 6.2.19.5.1.23 MULTIEDIT\_GetTextFromLine()

#### Description

Returns the text of a given line from a given start character.

#### Prototype

```
int MULTIEDIT_GetTextFromLine(MULTIEDIT_HANDLE hObj,
                              char * sDest,
                              int MaxLen,
                              unsigned CharPos,
                              unsigned Line);
```

#### Parameters

| Parameter            | Description   |
|----------------------|---|
| <code>hObj</code>    | Handle of MULTIEDIT widget.   |
| <code>sDest</code>   | Pointer to buffer.  |
| <code>MaxLen</code>  | Size of buffer.   |
| <code>CharPos</code> | Zero-based character position from which the text should be copied. |
| <code>Line</code>    | Zero-based line number.   |

#### Return value

Number of bytes copied.

#### Additional information

`Line` numbers are ambiguous when using any type of wrap mode, therefore a new line is considered after a line feed character.

The text from the line is returned without any carriage return nor line feed characters at the end.

#### Example

```
hWin = MULTIEDIT_CreateEx(10, 10, 200, 200, WM_HBKWIN, WM_CF_SHOW, 0, GUI_ID_MULTIEDIT0, 256,
                        "Line 0.\nLine 1.\nLine 2.\nLine 3.\nLine 4.");
MULTIEDIT_GetTextFromLine(hWin, acBuffer, sizeof(acBuffer), 0, 2); // "Line 2."
MULTIEDIT_GetTextFromLine(hWin, acBuffer, sizeof(acBuffer), 1, 4); // "ine 4."
```

### 6.2.19.5.1.24 MULTIEDIT\_GetTextFromPos()

#### Description

Returns the text from a start and end point. The start and end points are each specified by line number and character number, both being zero-based.

#### Prototype

```
int MULTIEDIT_GetTextFromPos(MULTIEDIT_HANDLE hObj,
                             char * sDest,
                             int MaxLen,
                             int CharStart,
                             int LineStart,
                             int CharEnd,
                             int LineEnd);
```

#### Parameters

| Parameter              | Description   |
|------------------------|---|
| <code>hObj</code>      | Handle of MULTIEDIT widget.   |
| <code>sDest</code>     | Pointer to buffer.  |
| <code>MaxLen</code>    | Size of buffer.   |
| <code>CharStart</code> | Zero-based start character in the start line.                                     |
| <code>LineStart</code> | Zero-based start line.  |
| <code>CharEnd</code>   | Zero-based end character in the end line. -1 equals to the last char of the line. |
| <code>LineEnd</code>   | Zero-based end line. -1 equals to the last line.                                  |

#### Return value

Number of bytes copied. -1 on error.

#### Additional information

Line numbers are ambiguous when using any type of wrap mode, therefore a new line is considered after a line feed character.

When one of the four parameters `CharStart`, `LineStart`, `CharEnd` or `LineEnd` is invalid (e.g. when the entered char/line position is too high), the function either skips to the next line or returns an error.

#### Example

```
hWin = MULTIEDIT_CreateEx(10, 10, 200, 200, WM_HBKWIN, WM_CF_SHOW, 0, GUI_ID_MULTIEDIT0, 256,
                        "Line 0.\nLine 1.\nLine 2.\nLine 3.\nLine 4.");

MULTIEDIT_GetTextFromPos(hWin, acBuffer, sizeof(acBuffer), 3, 1, 0, 3);
// "e 1.\nLine 2.\n"

MULTIEDIT_GetTextFromPos(hWin, acBuffer, sizeof(acBuffer), 0, 0, -1, 3);
// "Line 0.\nLine 1.\nLine 2.\nLine 3."

MULTIEDIT_GetTextFromPos(hWin, acBuffer, sizeof(acBuffer), 0, 0, 0, -1);
// "Line 0.\nLine 1.\nLine 2.\nLine 3.\n"
```

### 6.2.19.5.1.25 MULTIEDIT\_GetTextSize()

#### Description

Returns the buffer size used to store the current text (and prompt).

#### Prototype

```
int MULTIEDIT_GetTextSize(MULTIEDIT_HANDLE hObj);
```

#### Parameters

| Parameter            | Description                 |
|----------------------|-----------------------------|
| <a href="#">hObj</a> | Handle of MULTIEDIT widget. |

#### Return value

Buffer size used to store the current text (and prompt).

### 6.2.19.5.1.26 MULTIEDIT\_GetUserData()

#### Description

Prototype explained at the beginning of the chapter as `<WIDGET>_GetUserData()` on page 994.

### 6.2.19.5.1.27 MULTIEDIT\_SetAutoScrollH()

#### Description

Enables/disables the automatic use of a horizontal scroll bar.

#### Prototype

```
void MULTIEDIT_SetAutoScrollH(MULTIEDIT_HANDLE hObj,  
                              int OnOff);
```

#### Parameters

| Parameter          | Description   |
|--------------------|---|
| <code>hObj</code>  | Handle of MULTIEDIT widget.   |
| <code>OnOff</code> | 1 for enabling automatic use of a horizontal scroll bar, 0 for disabling. |

#### Additional information

Enabling the use of a automatic horizontal scroll bar only makes sense with the non wrapping mode explained later in this chapter. If enabled the MULTIEDIT widget checks if the width of the non wrapped text fits into the client area. If not a horizontal scroll bar will be attached to the window.

Note that enabling scrollbars will disable motion support for the widget.



### 6.2.19.5.1.28 MULTIEDIT\_SetAutoScrollV()

#### Description

Enables/disables the automatic use of a vertical scroll bar.

#### Prototype

```
void MULTIEDIT_SetAutoScrollV(MULTIEDIT_HANDLE hObj,  
                              int OnOff);
```

#### Parameters

| Parameter          | Description   |
|--------------------|---|
| <code>hObj</code>  | Handle of MULTIEDIT widget.   |
| <code>OnOff</code> | 1 for enabling automatic use of a vertical scroll bar, 0 for disabling. |

#### Additional information

If enabled the MULTIEDIT widget checks if the height of the text fits into the client area. If not a vertical scroll bar will be attached to the window.

Note that enabling scrollbars will disable motion support for the widget.

### 6.2.19.5.1.29 MULTIEDIT\_SetBkColor()

#### Description

Sets the background color of the given MULTIEDIT widget.

#### Prototype

```
void MULTIEDIT_SetBkColor(MULTIEDIT_HANDLE hObj,  
                          unsigned Index,  
                          GUI_COLOR color);
```

#### Parameters

| Parameter             | Description  |
|-----------------------|--|
| <a href="#">hObj</a>  | Handle of MULTIEDIT widget.  |
| <a href="#">Index</a> | See <i>MULTIEDIT color indexes</i> on page 1787 for a full list of permitted values. |
| <a href="#">Color</a> | Background color to be used.   |

### 6.2.19.5.1.30 MULTIEDIT\_SetBufferSize()

#### Description

Sets the maximum number of bytes used by text and prompt.

#### Prototype

```
void MULTIEDIT_SetBufferSize(MULTIEDIT_HANDLE hObj,  
                             int BufferSize);
```

#### Parameters

| Parameter               | Description                 |
|-------------------------|-----------------------------|
| <code>hObj</code>       | Handle of MULTIEDIT widget. |
| <code>BufferSize</code> | Maximum number of bytes.    |

#### Additional information

The function clears the current content of the MULTIEDIT widget and allocates the given number of bytes for the text and for the prompt.

### 6.2.19.5.1.31 MULTIEDIT\_SetCursorCharPos()

#### Description

This function sets the cursor to the given position where **x** is the character in a line and **y** is line. 0, 0 is the very first character. 0, 1 would be the the first character of the second line and so on.

#### Prototype

```
void MULTIEDIT_SetCursorCharPos(MULTIEDIT_HANDLE hObj,  
                                int x,  
                                int y);
```

#### Parameters

| Parameter   | Description                         |
|-------------|-------------------------------------|
| <b>hObj</b> | Handle of MULTIEDIT widget.         |
| <b>x</b>    | X - Character position of the line. |
| <b>y</b>    | Y - Index of line.                  |

### 6.2.19.5.1.32 MULTIEDIT\_SetCursorColor()

#### Description

Sets the background or foreground cursor color of the given MULTIEDIT widget.

#### Prototype

```
void MULTIEDIT_SetCursorColor(MULTIEDIT_HANDLE hObj,
                             unsigned          Index,
                             GUI_COLOR        color);
```

#### Parameters

| Parameter             | Description   |
|-----------------------|---|
| <a href="#">hObj</a>  | Handle of MULTIEDIT widget.   |
| <a href="#">Index</a> | See <i>LISTBOX cursor color indexes</i> on page <a href="#">1762</a> for a full list of permitted values. |
| <a href="#">Color</a> | <a href="#">Color</a> to be used.   |

#### Additional information

These colors are taken into account only if the inversion mode of the cursor is disabled.

### 6.2.19.5.1.33 MULTIEDIT\_SetCursorOffset()

#### Description

Sets the cursor position to the given character.

#### Prototype

```
void MULTIEDIT_SetCursorOffset(MULTIEDIT_HANDLE hObj,  
                               int Offset);
```

#### Parameters

| Parameter           | Description                 |
|---------------------|-----------------------------|
| <code>hObj</code>   | Handle of MULTIEDIT widget. |
| <code>Offset</code> | New cursor position.        |

#### Additional information

The number of characters used for the prompt has to be added to the parameter `Offset`. If a prompt is used the value for parameter `Offset` should not be smaller than the number of characters used for the prompt.

### 6.2.19.5.1.34 MULTIEDIT\_SetCursorPixelPos()

#### Description

This function sets the cursor to the given position, where x and y are the coordinates in pixels relative to the widget.

#### Prototype

```
void MULTIEDIT_SetCursorPixelPos(MULTIEDIT_HANDLE hObj,  
                                int x,  
                                int y);
```

#### Parameters

| Parameter            | Description                 |
|----------------------|-----------------------------|
| <a href="#">hObj</a> | Handle of MULTIEDIT widget. |
| <a href="#">xPos</a> | X position in pixels.       |
| <a href="#">yPos</a> | Y position in pixels.       |

### 6.2.19.5.1.35 MULTIEDIT\_SetDefaultAlign()

#### Description

Sets the default text alignment for new MULTIEDIT widgets.

#### Prototype

```
void MULTIEDIT_SetDefaultAlign(int Align);
```

#### Parameters

| Parameter             | Description  |
|-----------------------|--|
| <a href="#">Align</a> | See <i>Text alignment flags</i> on page 252. <b>Only horizontal left and right alignment flags are applicable!</b> |



### 6.2.19.5.1.36 MULTIEDIT\_SetDefaultBkColor()

#### Description

Sets the default background color for new MULTIEDIT widgets.

#### Prototype

```
void MULTIEDIT_SetDefaultBkColor(GUI_COLOR Color,  
                                unsigned Index);
```

#### Parameters

| Parameter | Description  |
|-----------|--|
| Color     | Color to be used.  |
| Index     | See <i>MULTIEDIT color indexes</i> on page 1787 for a full list of permitted values. |

### 6.2.19.5.1.37 MULTIEDIT\_SetDefaultCursorColor()

#### Description

Sets the default cursor color for new MULTIEDIT widgets.

#### Prototype

```
void MULTIEDIT_SetDefaultCursorColor(GUI_COLOR Color,  
                                     unsigned Index);
```

#### Parameters

| Parameter | Description  |
|-----------|--|
| Color     | Color to be used.  |
| Index     | See <i>MULTIEDIT color indexes</i> on page 1787 for a full list of permitted values. |

### 6.2.19.5.1.38 MULTIEDIT\_SetDefaultFont()

#### Description

Sets the default font for new MULTIEDIT widgets.

#### Prototype

```
void MULTIEDIT_SetDefaultFont(const GUI_FONT * pFont);
```

#### Parameters

| Parameter          | Description                                 |
|--------------------|---|
| <code>pFont</code> | Pointer to a GUI_FONT structure to be used. |

### 6.2.19.5.1.39 MULTIEDIT\_SetDefaultHBorder()

#### Description

Sets the default horizontal border for new MULTIEDIT widgets.

#### Prototype

```
void MULTIEDIT_SetDefaultHBorder(unsigned HBorder);
```

#### Parameters

| Parameter | Description                       |
|-----------|-----------------------------------|
| HBorder   | New horizontal border to be used. |

#### 6.2.19.5.1.40 MULTIEDIT\_SetDefaultTextColor()

##### Description

Sets the default text color for new MULTIEDIT widgets.

##### Prototype

```
void MULTIEDIT_SetDefaultTextColor(GUI_COLOR Color,  
                                   unsigned Index);
```

##### Parameters

| Parameter | Description  |
|-----------|--|
| Color     | Color to be used.  |
| Index     | See <i>MULTIEDIT color indexes</i> on page 1787 for a full list of permitted values. |

#### 6.2.19.5.1.41 MULTIEDIT\_SetFocusable()

##### Description

Sets the focusability of the given MULTIEDIT widget.

##### Prototype

```
void MULTIEDIT_SetFocusable(MULTIEDIT_HANDLE hObj,  
                             int State);
```

##### Parameters

| Parameter          | Description                                   |
|--------------------|---|
| <code>hObj</code>  | Handle of MULTIEDIT widget.                   |
| <code>OnOff</code> | 1 for enabling focusability, 0 for disabling. |

##### Additional information

The text can not be aligned to the center if the widget is focusable. To change text alignment, the function `MULTIEDIT_SetTextAlign()` can be used.

#### 6.2.19.5.1.42 MULTIEDIT\_SetFont()

##### Description

Sets the font used to display the text and the prompt.

##### Prototype

```
void MULTIEDIT_SetFont(      MULTIEDIT_HANDLE  hObj,  
                           const GUI_FONT     * pFont);
```

##### Parameters

| Parameter          | Description                 |
|--------------------|-----------------------------|
| <code>hObj</code>  | Handle of MULTIEDIT widget. |
| <code>pFont</code> | Pointer to font to be used. |

### 6.2.19.5.1.43 MULTIEDIT\_SetHBorder()

#### Description

Sets the size of the border between the text and the widget in horizontal direction.

#### Prototype

```
void MULTIEDIT_SetHBorder(MULTIEDIT_HANDLE hObj,  
                          unsigned         HBorder);
```

#### Parameters

| Parameter               | Description                   |
|-------------------------|-------------------------------|
| <a href="#">hObj</a>    | Handle of MULTIEDIT widget.   |
| <a href="#">HBorder</a> | Size of the border in pixels. |



#### 6.2.19.5.1.44 MULTIEDIT\_SetInsertMode()

##### Description

Enables/disables the insert mode. The default behaviour is overwrite mode.

##### Prototype

```
void MULTIEDIT_SetInsertMode(MULTIEDIT_HANDLE hObj,  
                             int OnOff);
```

##### Parameters

| Parameter          | Description                                  |
|--------------------|--|
| <code>hObj</code>  | Handle of MULTIEDIT widget.                  |
| <code>OnOff</code> | 1 for enabling insert mode, 0 for disabling. |

### 6.2.19.5.1.45 MULTIEDIT\_SetInvertCursor()

#### Description

Enables/disables the inversion mode of cursor. The default behaviour is invert mode.

#### Prototype

```
void MULTIEDIT_SetInvertCursor(MULTIEDIT_HANDLE hObj,  
                               int OnOff);
```

#### Parameters

| Parameter             | Description                                  |
|-----------------------|--|
| <a href="#">hObj</a>  | Handle of MULTIEDIT widget.                  |
| <a href="#">OnOff</a> | 1 for enabling invert mode, 0 for disabling. |

#### Additional information

Cursor colors need to be set.

### 6.2.19.5.1.46 MULTIEDIT\_SetMaxNumChars()

#### Description

Sets the maximum number of characters used by text and prompt.

#### Prototype

```
void MULTIEDIT_SetMaxNumChars (MULTIEDIT_HANDLE hObj,  
                               unsigned          MaxNumChars);
```

#### Parameters

| Parameter                   | Description                     |
|-----------------------------|---------------------------------|
| <a href="#">hObj</a>        | Handle of the MULTIEDIT widget. |
| <a href="#">MaxNumChars</a> | Maximum number of characters.   |

### 6.2.19.5.1.47 MULTIEDIT\_SetPasswordMode()

#### Description

Enables/disables the password mode.

#### Prototype

```
void MULTIEDIT_SetPasswordMode(MULTIEDIT_HANDLE hObj,  
                               int OnOff);
```

#### Parameters

| Parameter          | Description                                    |
|--------------------|--|
| <code>hObj</code>  | Handle of the MULTIEDIT widget.                |
| <code>OnOff</code> | 1 for enabling password mode, 0 for disabling. |

#### Additional information

The password mode enables you to conceal the user input.

### 6.2.19.5.1.48 MULTIEDIT\_SetPrompt()

#### Description

Sets the prompt text.

#### Prototype

```
void MULTIEDIT_SetPrompt(      MULTIEDIT_HANDLE  hObj,  
                             const char         * pPrompt);
```

#### Parameters

| Parameter            | Description                     |
|----------------------|---------------------------------|
| <code>hObj</code>    | Handle of the MULTIEDIT widget. |
| <code>sPrompt</code> | Pointer to the new prompt text. |

#### Additional information

The prompt text is displayed first. The cursor can not be moved into the prompt.

### 6.2.19.5.1.49 MULTIEDIT\_SetReadOnly()

#### Description

Enables/disables the read only mode.

#### Prototype

```
void MULTIEDIT_SetReadOnly(MULTIEDIT_HANDLE hObj,  
                           int OnOff);
```

#### Parameters

| Parameter          | Description                                     |
|--------------------|---|
| <code>hObj</code>  | Handle of the MULTIEDIT widget.                 |
| <code>OnOff</code> | 1 for enabling read-only mode, 0 for disabling. |

#### Additional information

If the read only mode has been set the widget does not change the text. Only the cursor will be moved.

### 6.2.19.5.1.50 MULTIEDIT\_SetText()

#### Description

Sets the text to be handled by the MULTIEDIT widget.

#### Prototype

```
void MULTIEDIT_SetText(      MULTIEDIT_HANDLE  hObj,  
                           const char        * pNew);
```

#### Parameters

| Parameter         | Description  |
|-------------------|--|
| <code>hObj</code> | Handle of the MULTIEDIT widget.                            |
| <code>pNew</code> | Pointer to the text to be handled by the MULTIEDIT widget. |

#### Additional information

The function copies the given text to the buffer allocated when creating the widget. The current text can be retrieved by `MULTIEDIT_GetText()`.

### 6.2.19.5.1.51 MULTIEDIT\_SetTextAlign()

#### Description

Sets the text alignment for the given MULTIEDIT widget.

#### Prototype

```
void MULTIEDIT_SetTextAlign(MULTIEDIT_HANDLE hObj,  
                           int Align);
```

#### Parameters

| Parameter          | Description  |
|--------------------|--|
| <code>hObj</code>  | Handle of the MULTIEDIT widget.  |
| <code>Align</code> | See <i>Text alignment flags</i> on page 252. <b>Only horizontal left and right alignment flags are applicable!</b> |

#### Additional information

The text can not be horizontally centered if the widget is focusable. To change focusability of the widget, the function `MULTIEDIT_SetFocusable()` can be used.



### 6.2.19.5.1.52 MULTIEDIT\_SetTextColor()

#### Description

Sets the text color.

#### Prototype

```
void MULTIEDIT_SetTextColor(MULTIEDIT_HANDLE hObj,  
                           unsigned Index,  
                           GUI_COLOR color);
```

#### Parameters

| Parameter             | Description  |
|-----------------------|--|
| <a href="#">hObj</a>  | Handle of the MULTIEDIT widget.  |
| <a href="#">Index</a> | See <i>MULTIEDIT color indexes</i> on page 1787 for a full list of permitted values. |
| <a href="#">Color</a> | Text color to be used.   |

### 6.2.19.5.1.53 MULTIEDIT\_SetUserData()

#### Description

Prototype explained at the beginning of the chapter as `<WIDGET>_SetUserData()` on page 995.

#### 6.2.19.5.1.54 MULTIEDIT\_SetWrapChar()

##### Prototype

```
void MULTIEDIT_SetWrapChar(MULTIEDIT_HANDLE hObj);
```

### 6.2.19.5.1.55 MULTIEDIT\_SetWrapNone()

#### Description

Enables the non wrapping mode.

#### Prototype

```
void MULTIEDIT_SetWrapNone (MULTIEDIT_HANDLE hObj) ;
```

#### Parameters

| Parameter            | Description                 |
|----------------------|-----------------------------|
| <a href="#">hObj</a> | Handle of MULTIEDIT widget. |

#### Additional information

'Non wrapping' means line wrapping would be done only at new lines. If the horizontal size of the text exceeds the size of the client area the text will be scrolled.

### 6.2.19.5.1.56 MULTIEDIT\_SetWrapWord()

#### Description

Enables the word wrapping mode.

#### Prototype

```
void MULTIEDIT_SetWrapWord(MULTIEDIT_HANDLE hObj);
```

#### Parameters

| Parameter            | Description                 |
|----------------------|-----------------------------|
| <a href="#">hObj</a> | Handle of MULTIEDIT widget. |

#### Additional information

If the word wrapping mode has been set the text at the end of a line will be wrapped at the beginning of the last word (if possible).

### 6.2.19.5.1.57 MULTIEDIT\_ShowCursor()

#### Description

This function enables or disables the cursor of the MULTIEDIT widget.

#### Prototype

```
int MULTIEDIT_ShowCursor(MULTIEDIT_HANDLE hObj,  
                        unsigned OnOff);
```

#### Parameters

| Parameter          | Description                  |
|--------------------|------------------------------|
| <code>hObj</code>  | Handle of MULTIEDIT widget.  |
| <code>OnOff</code> | 0 hide cursor, 1 show cursor |

#### Return value

This function returns the previous state of the cursor.

## 6.2.19.5.2 Defines

### 6.2.19.5.2.1 MULTIEDIT color indexes

#### Description

Color indexes used by the MULTIEDIT widget.

#### Definition

```
#define MULTIEDIT_CI_EDIT      0
#define MULTIEDIT_CI_READONLY 1
```

#### Symbols

| Definition                            | Description              |
|---------------------------------------|--------------------------|
| <a href="#">MULTIEDIT_CI_EDIT</a>     | Color in edit mode.      |
| <a href="#">MULTIEDIT_CI_READONLY</a> | Color in read-only mode. |

### 6.2.19.5.2.2 MULTIEDIT cursor color indexes

#### Description

Color indexes used for the cursor of the MULTIEDIT widget.

#### Definition

```
#define MULTIEDIT_CI_CURSOR_BK    2
#define MULTIEDIT_CI_CURSOR_FG    3
```

#### Symbols

| Definition                             | Description                 |
|--|-----------------------------|
| <a href="#">MULTIEDIT_CI_CURSOR_BK</a> | Background color for cursor |
| <a href="#">MULTIEDIT_CI_CURSOR_FG</a> | Foreground color for cursor |



### 6.2.19.5.2.3 MULTIEDIT create flags

#### Description

Create flags that define the behavior of the FRAMEWIN widget. These flags are OR-combinable and can be specified upon creation of the widget via the `ExFlags` parameter of `MULTIEDIT_CreateEx()`.

#### Definition

```
#define MULTIEDIT_CF_READONLY          (1 << 0)
#define MULTIEDIT_CF_INSERT           (1 << 2)
#define MULTIEDIT_CF_AUTOSCROLLBAR_V  (1 << 3)
#define MULTIEDIT_CF_AUTOSCROLLBAR_H  (1 << 4)
#define MULTIEDIT_CF_PASSWORD         (1 << 5)
#define MULTIEDIT_CF_SHOWCURSOR       (1 << 6)
#define MULTIEDIT_CF_MOTION_H         (1 << 7)
#define MULTIEDIT_CF_MOTION_V         (1 << 8)
```

#### Symbols

| Definition                                | Description                               |
|---|---|
| <code>MULTIEDIT_CF_READONLY</code>        | Enables read only mode.                   |
| <code>MULTIEDIT_CF_INSERT</code>          | Enables insert mode.                      |
| <code>MULTIEDIT_CF_AUTOSCROLLBAR_V</code> | Automatic use of a vertical scroll bar.   |
| <code>MULTIEDIT_CF_AUTOSCROLLBAR_H</code> | Automatic use of a horizontal scroll bar. |
| <code>MULTIEDIT_CF_PASSWORD</code>        | Enables password mode.                    |
| <code>MULTIEDIT_CF_SHOWCURSOR</code>      | Shows the cursor.                         |
| <code>MULTIEDIT_CF_MOTION_H</code>        | Enables motion support on X-axis.         |
| <code>MULTIEDIT_CF_MOTION_V</code>        | Enables motion support on Y-axis.         |

## 6.2.19.6 Example

The `Sample` folder contains the following example which shows how the widget can be used:

- `WIDGET_MultiEdit.c`

Note that several other examples also make use of this widget and may also be helpful to get familiar with it.

### Screenshot of `WIDGET_Multiedit.c`

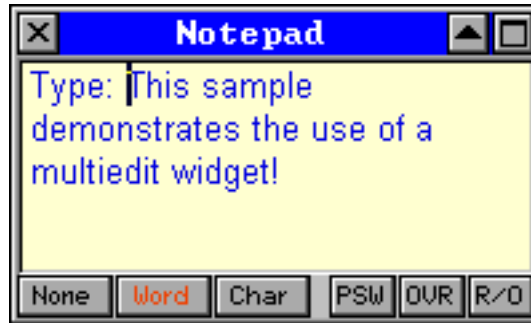

## 6.2.20 MULTIPAGE: Multiple page widget

A MULTIPAGE widget is analogous to the dividers in a notebook or the labels in a file cabinet. By using a MULTIPAGE widget, an application can define multiple pages for the same area of a window or dialog box. Each page consists of a certain type of information or a group of widgets that the application displays when the user selects the corresponding page. To select a page the tab of the page has to be clicked. If not all tabs can be displayed, the MULTIPAGE widget automatically shows a small scroll bar at the edge to scroll the pages. The `Sample` folder contains the file `WIDGET_Multipage.c` which shows how to create and use the MULTIPAGE widget.

### Note

All MULTIPAGE-related routines are located in the file(s) `MULTIPAGE*.c`, `MULTIPAGE.h`. All identifiers are prefixed `MULTIPAGE`.

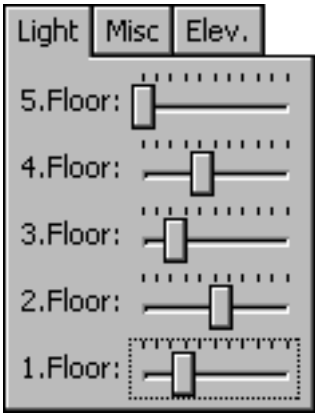
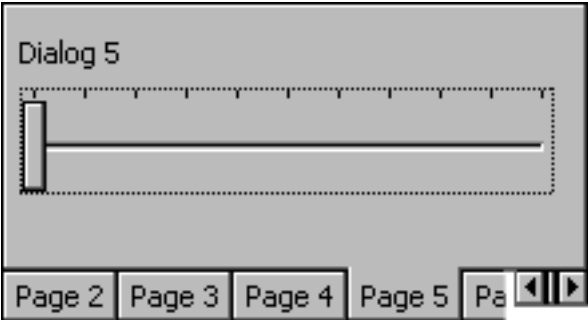
| Description   | MULTIPAGE widget   |
|---|--|
| <p>MULTIPAGE widget with 3 pages, alignment top/left.</p>     |   |
| <p>MULTIPAGE widget with 6 pages, alignment bottom/right.</p> |  |

### Skining...

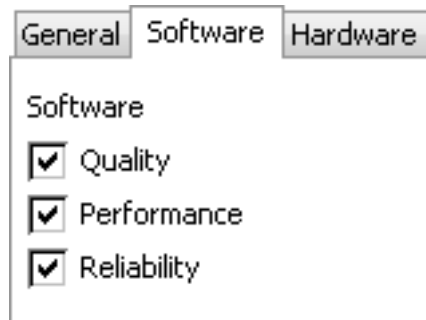

...is available for this widget. The screenshot above shows the widget using the default skin. Details can be found in the chapter *Skining* on page 2509.

## Structure of MULTIPAGE widget

A MULTIPAGE widget with n pages consists of n+2 windows:

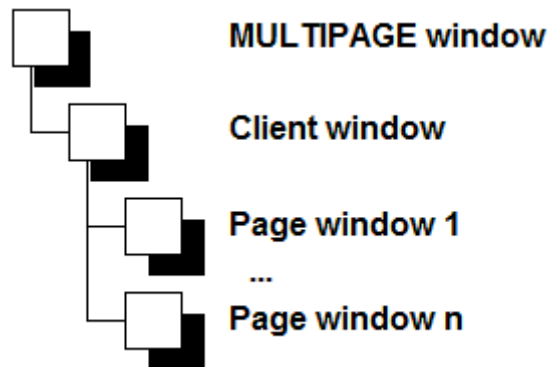

- 1 MULTIPAGE window
- 1 Client window
- n Page windows

The page windows will be added to the client window of the widget. The diagram at the right side shows the structure of the widget.

### 6.2.20.1 Configuration options

| Type | Macro                        | Default                                       | Description  |
|------|------------------------------|---|--|
| N    | MULTIPAGE_ALIGN_DEFAULT      | MULTIPAGE_ALIGN_LEFT<br>  MULTIPAGE_ALIGN_TOP | Default alignment.                                   |
| N    | MULTIPAGE_BKCOLOR0_DEFAULT   | 0xD0D0D0                                      | Default background color of pages in disabled state. |
| N    | MULTIPAGE_BKCOLOR1_DEFAULT   | 0xC0C0C0                                      | Default background color of pages in enabled state.  |
| S    | MULTIPAGE_FONT_DEFAULT       | &GUI_Font13_1                                 | Default font used by the widget.                     |
| N    | MULTIPAGE_TEXTCOLOR0_DEFAULT | 0x808080                                      | Default text color of pages in disabled state.       |
| N    | MULTIPAGE_TEXTCOLOR1_DEFAULT | 0x000000                                      | Default text color of pages in enabled state.        |

### 6.2.20.2 Predefined IDs

The following symbols define IDs which may be used to make MULTIPAGE widgets distinguishable from creation.

```
#define GUI_ID_MULTIPAGE0    0x230
#define GUI_ID_MULTIPAGE1    0x231
#define GUI_ID_MULTIPAGE2    0x232
#define GUI_ID_MULTIPAGE3    0x233
#define GUI_ID_MULTIPAGE4    0x234
#define GUI_ID_MULTIPAGE5    0x235
#define GUI_ID_MULTIPAGE6    0x236
#define GUI_ID_MULTIPAGE7    0x237
#define GUI_ID_MULTIPAGE8    0x238
#define GUI_ID_MULTIPAGE9    0x239
```

### 6.2.20.3 Notification codes

The following events are sent from the widget to its parent window as part of a WM\_NOTIFY\_PARENT message:

| Message                       | Description   |
|-------------------------------|---|
| WM_NOTIFICATION_CLICKED       | Widget has been clicked.  |
| WM_NOTIFICATION_RELEASED      | Widget has been released.   |
| WM_NOTIFICATION_MOVED_OUT     | Widget has been clicked and pointer has been moved out of the widget without releasing. |
| WM_NOTIFICATION_VALUE_CHANGED | The text of the widget has been changed.  |

### 6.2.20.4 Keyboard reaction

The widget reacts to the following keys if it has the input focus:

| Key            | Reaction                       |
|----------------|--------------------------------|
| GUI_KEY_PGUP   | Switches to the next page.     |
| GUI_KEY_PGDOWN | Switches to the previous page. |

### 6.2.20.5 MULTIPAGE API

The table below lists the available emWin MULTIPAGE-related routines in alphabetical order. Detailed descriptions of the routines follow.

#### Functions

| Routine                                    | Description  |
|--|--|
| <code>MULTIPAGE_AddEmptyPage()</code>      | Adds a page to a MULTIPAGE widget without the requirement to attach a window.                |
| <code>MULTIPAGE_AddPage()</code>           | Adds a page to a MULTIPAGE widget.   |
| <code>MULTIPAGE_AttachWindow()</code>      | Attaches a window to a certain page of the MULTIPAGE widget.                                 |
| <code>MULTIPAGE_CreateEx()</code>          | Creates a MULTIPAGE widget.  |
| <code>MULTIPAGE_CreateIndirect()</code>    | Creates a MULTIPAGE widget from a resource table entry.                                      |
| <code>MULTIPAGE_CreateUser()</code>        | Creates a MULTIPAGE widget using extra bytes as user data.                                   |
| <code>MULTIPAGE_DeletePage()</code>        | Deletes a page from a MULTIPAGE widget.  |
| <code>MULTIPAGE_DisablePage()</code>       | Disables a page from a MULTIPAGE widget.   |
| <code>MULTIPAGE_EnablePage()</code>        | Enables a page from a MULTIPAGE widget.  |
| <code>MULTIPAGE_EnableScrollbar()</code>   | Configures the given MULTIPAGE widget to make use of an automatic scroll bar.                |
| <code>MULTIPAGE_GetBkColor()</code>        | Returns the background color.  |
| <code>MULTIPAGE_GetDefaultAlign()</code>   | Returns the default tab alignment for new MULTIPAGE widgets.                                 |
| <code>MULTIPAGE_GetDefaultBkColor()</code> | Returns the default background color for new MULTIPAGE widgets.                              |
| <code>MULTIPAGE_GetDefaultFont()</code>    | Returns a pointer to the font used to display the text in the tabs of new MULTIPAGE widgets. |

| Routine  | Description   |
|--|---|
| <code>MULTIPAGE_GetDefaultTextColor()</code>   | Returns the default text color used to display the text in the tabs of new MULTIPAGE widgets. |
| <code>MULTIPAGE_GetFont()</code>               | Returns the font of the widget.   |
| <code>MULTIPAGE_GetNumTabs()</code>            | Returns the number of all tabs in a MULTIPAGE widget.   |
| <code>MULTIPAGE_GetPageText()</code>           | Returns the text of the given page.   |
| <code>MULTIPAGE_GetSelection()</code>          | Returns the current selection.  |
| <code>MULTIPAGE_GetTabHeight()</code>          | Returns the height for all tabs.  |
| <code>MULTIPAGE_GetTabWidth()</code>           | Returns the width for the given tab.  |
| <code>MULTIPAGE_GetTextColor()</code>          | Returns the text color of the widget.   |
| <code>MULTIPAGE_GetUserData()</code>           | Retrieves the data set with <code>MULTIPAGE_SetUserData()</code> .                            |
| <code>MULTIPAGE_GetWindow()</code>             | Returns the handle of the window displayed in the given page.                                 |
| <code>MULTIPAGE_IsPageEnabled()</code>         | Returns if the given page of a MULTIEDIT widget is enabled or not.                            |
| <code>MULTIPAGE_SelectPage()</code>            | Sets the currently selected page of a MULTIPAGE widget.                                       |
| <code>MULTIPAGE_SetAlign()</code>              | Sets the alignment for the tabs.  |
| <code>MULTIPAGE_SetBitmap()</code>             | Sets a bitmap to be displayed on the given tab.   |
| <code>MULTIPAGE_SetBitmapEx()</code>           | Sets a bitmap to be displayed at the specified position on the given tab.                     |
| <code>MULTIPAGE_SetBkColor()</code>            | Sets the background color of the given MULTIPAGE widget.                                      |
| <code>MULTIPAGE_SetDefaultAlign()</code>       | Sets the default tab alignment for new MULTIPAGE widgets.                                     |
| <code>MULTIPAGE_SetDefaultBkColor()</code>     | Sets the default background color used for new MULTIPAGE widgets.                             |
| <code>MULTIPAGE_SetDefaultBorderSizeX()</code> | Sets the default border size on the x-axis.   |
| <code>MULTIPAGE_SetDefaultBorderSizeY()</code> | Sets the default border size on the y-axis.   |
| <code>MULTIPAGE_SetDefaultFont()</code>        | Sets the default font used by new MULTIPAGE widgets.  |
| <code>MULTIPAGE_SetDefaultTextColor()</code>   | Sets the default text color used by new MULTIPAGE widgets.                                    |
| <code>MULTIPAGE_SetFont()</code>               | Selects the font for the widget.  |
| <code>MULTIPAGE_SetRotation()</code>           | Sets the rotation mode of the given widget.   |
| <code>MULTIPAGE_SetTabHeight()</code>          | Sets the height for all tabs.   |
| <code>MULTIPAGE_SetTabWidth()</code>           | Sets the width for the given tab.   |
| <code>MULTIPAGE_SetText()</code>               | Sets the text displayed in the tab of a given page.   |
| <code>MULTIPAGE_SetTextAlign()</code>          | Sets the text alignment for the given MULTIPAGE widget.                                       |
| <code>MULTIPAGE_SetTextColor()</code>          | Sets the text color.  |
| <code>MULTIPAGE_SetUserData()</code>           | Sets the extra data of a MULTIPAGE widget.  |

## Defines

| Group of defines                          | Description   |
|---|---|
| <a href="#">MULTIPAGE alignment flags</a> | Alignment flags used by <code>MULTIPAGE_SetAlign()</code> . |
| <a href="#">MULTIPAGE bitmap indexes</a>  | Bitmap indexes used by the MULTIPAGE widget.                |
| <a href="#">MULTIPAGE color indexes</a>   | Color indexes used by the MULTIPAGE widget.                 |
| <a href="#">MULTIPAGE create flags</a>    | Create flags used by the MULTIPAGE widget.                  |

## 6.2.20.5.1 Functions

### 6.2.20.5.1.1 MULTIPAGE\_AddEmptyPage()

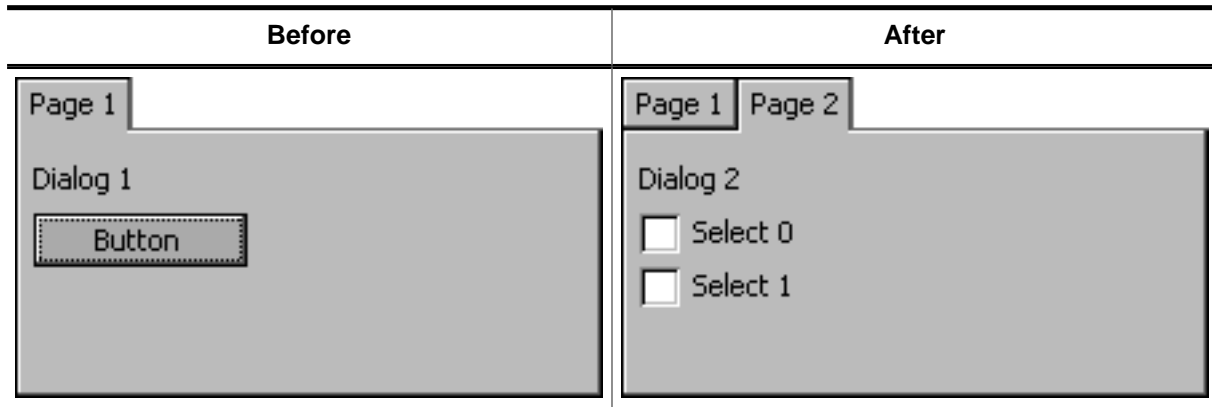

#### Description

Adds a new page to a given MULTIPAGE widget.

#### Prototype

```
void MULTIPAGE_AddEmptyPage(    MULTIPAGE_Handle  hObj,
                               WM_HWIN                  hWin,
                               const char                  * pText);
```

#### Parameters

| Parameter          | Description   |
|--------------------|---|
| <code>hObj</code>  | Handle of MULTIPAGE widget.                             |
| <code>hWin</code>  | Handle of window to be shown in the given page.         |
| <code>pText</code> | Pointer to text to be displayed in the tab of the page. |

#### Additional information

It is recommended, that all windows added to a MULTIPAGE widget handle the complete client area of the MULTIPAGE widget when processing the WM\_PAINT message. If no window has to be added, `hWin` can be specified with 0.



### 6.2.20.5.1.2 MULTIPAGE\_AddPage()

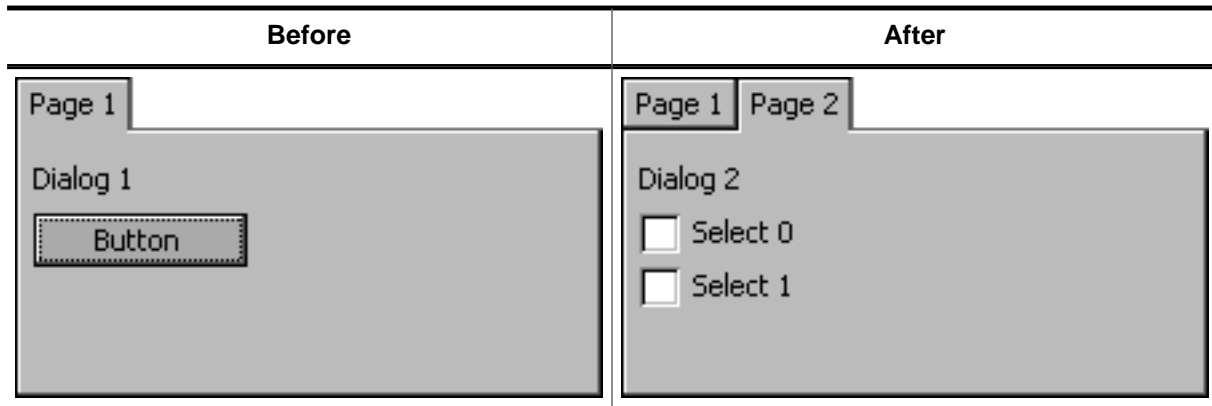

#### Description

Adds a new page to a given MULTIPAGE widget.

#### Prototype

```
void MULTIPAGE_AddPage(    MULTIPAGE_Handle  hObj,
                          WM_HWIN                hWin,
                          const char                * pText);
```

#### Parameters

| Parameter          | Description   |
|--------------------|---|
| <code>hObj</code>  | Handle of MULTIPAGE widget.                             |
| <code>hWin</code>  | Handle of window to be shown in the given page.         |
| <code>pText</code> | Pointer to text to be displayed in the tab of the page. |

#### Additional information

It is recommended, that all windows added to a MULTIPAGE widget handle the complete client area of the MULTIPAGE widget when processing the `WM_PAINT` message.

### 6.2.20.5.1.3 MULTIPAGE\_AttachWindow()

#### Description

Attaches a window to a certain page of the MULTIPAGE widget.

#### Prototype

```
WM_HWIN MULTIPAGE_AttachWindow(MULTIPAGE_Handle hObj,  
                                unsigned          Index,  
                                WM_HWIN          hWin);
```

#### Parameters

| Parameter             | Description  |
|-----------------------|--|
| <a href="#">hObj</a>  | Handle of MULTIPAGE widget.                                      |
| <a href="#">Index</a> | <a href="#">Index</a> of the page the window has to be added to. |
| <a href="#">pText</a> | Pointer to text to be displayed in the tab of the page.          |

#### Additional information

It is recommended, that all windows added to a MULTIPAGE widget handle the complete client area of the MULTIPAGE widget when processing the `WM_PAINT` message.

### 6.2.20.5.1.4 MULTIPAGE\_CreateEx()

#### Description

Creates a MULTIPAGE widget of a specified size at a specified position.

#### Prototype

```
MULTIPAGE_Handle MULTIPAGE_CreateEx(int    x0,
                                     int    y0,
                                     int    xSize,
                                     int    ySize,
                                     WM_HWIN hParent,
                                     int    WinFlags,
                                     int    ExFlags,
                                     int    Id);
```

#### Parameters

| Parameter             | Description  |
|-----------------------|--|
| <code>x0</code>       | X-position of the MULTIPAGE widget (in parent coordinates).  |
| <code>y0</code>       | Y-position of the MULTIPAGE widget (in parent coordinates).  |
| <code>xSize</code>    | Horizontal size of the MULTIPAGE widget (in pixels).   |
| <code>ySize</code>    | Vertical size of the MULTIPAGE widget (in pixels).   |
| <code>hParent</code>  | Handle of parent window. If 0, the new widget will be a child of the desktop (top-level window).   |
| <code>WinFlags</code> | Window create flags. Typically <code>WM_CF_SHOW</code> in order to make the widget visible immediately (refer to <i>Window create flags</i> on page 977 for a list of available parameter values). |
| <code>ExFlags</code>  | Not used yet, reserved for future use.   |
| <code>Id</code>       | Window ID of the MULTIPAGE widget.   |

#### Return value

Handle of the new MULTIPAGE widget.

#### Additional information

The size of the tabs depends on the size of the font used for the MULTIPAGE widget.

### 6.2.20.5.1.5 MULTIPAGE\_CreateIndirect()

#### Description

The prototype of this function is explained at the beginning of this chapter. Details can be found in the description of the function `<WIDGET>_CreateIndirect()` on page 992. The element `Para` of the according `GUI_WIDGET_CREATE_INFO` structure is not used. The element `Flags` is used according to the parameter `ExFlags` of the function `MULTIPAGE_CreateEx()`.

### 6.2.20.5.1.6 MULTIPAGE\_CreateUser()

#### Description

Prototype explained at the beginning of the chapter as `<WIDGET>_CreateUser()` on page 993. For a detailed description of the parameters the function `MULTIPAGE_CreateEx()` can be referred to.

### 6.2.20.5.1.7 MULTIPAGE\_DeletePage()

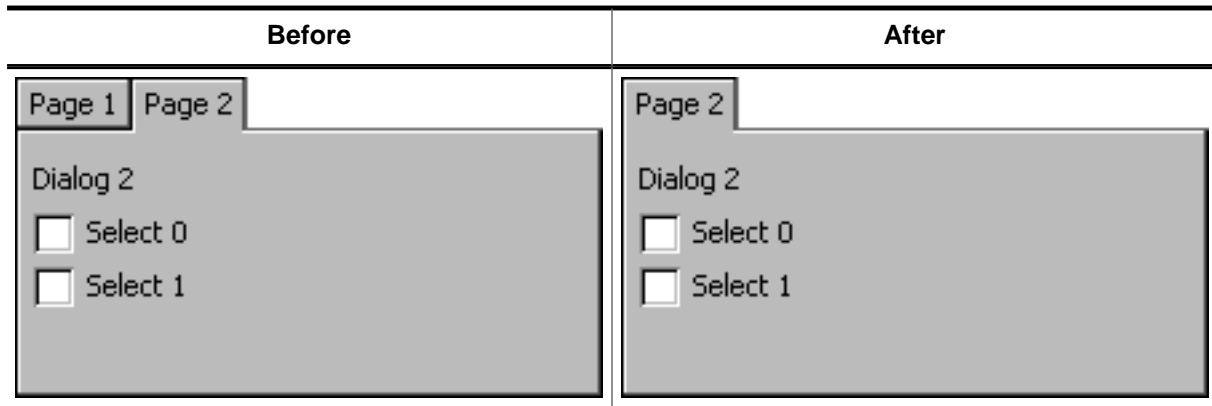

#### Description

Removes a page from a MULTIPAGE widget and optional deletes the window.

#### Prototype

```
void MULTIPAGE_DeletePage(MULTIPAGE_Handle hObj,
                          unsigned Index,
                          int Delete);
```

#### Parameters

| Parameter           | Description   |
|---------------------|---|
| <code>hObj</code>   | Handle of MULTIPAGE widget.   |
| <code>Index</code>  | Zero based index of the page to be removed from the MULTIPAGE widget. |
| <code>Delete</code> | If >0 the window attached to the page will be deleted.                |

### 6.2.20.5.1.8 MULTIPAGE\_DisablePage()

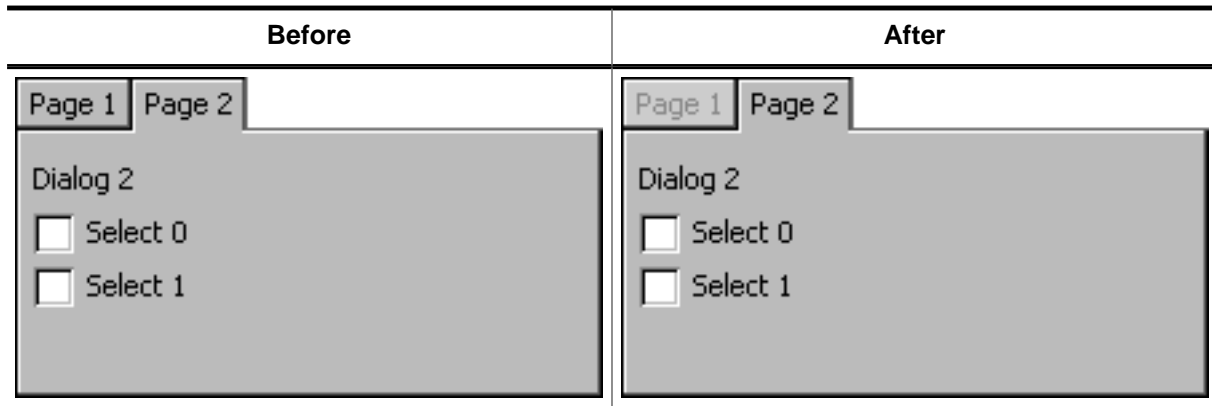

#### Description

Disables a page from a MULTIPAGE widget.

#### Prototype

```
void MULTIPAGE_DisablePage(MULTIPAGE_Handle hObj,
                           unsigned Index);
```

#### Parameters

| Parameter          | Description                                  |
|--------------------|--|
| <code>hObj</code>  | Handle of MULTIPAGE widget.                  |
| <code>Index</code> | Zero based index of the page to be disabled. |

#### Additional information

A disabled page of a window can not be selected by clicking the tab of the page. The default state of MULTIEDIT pages is 'enabled'.

### 6.2.20.5.1.9 MULTIPAGE\_EnablePage()

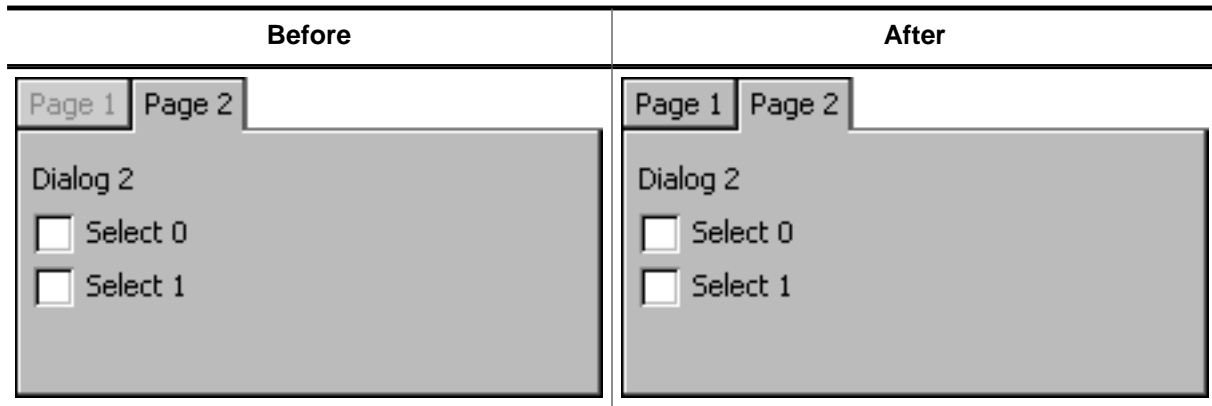

#### Description

Enables a page of a MULTIPAGE widget.

#### Prototype

```
void MULTIPAGE_EnablePage(MULTIPAGE_Handle hObj,
                          unsigned Index);
```

#### Parameters

| Parameter         | Description                 |
|-------------------|-----------------------------|
| <code>hObj</code> | Handle of MULTIPAGE widget. |

#### Additional information

The default state of MULTIEDIT pages is 'enabled'.



### 6.2.20.5.1.10 MULTIPAGE\_EnableScrollbar()

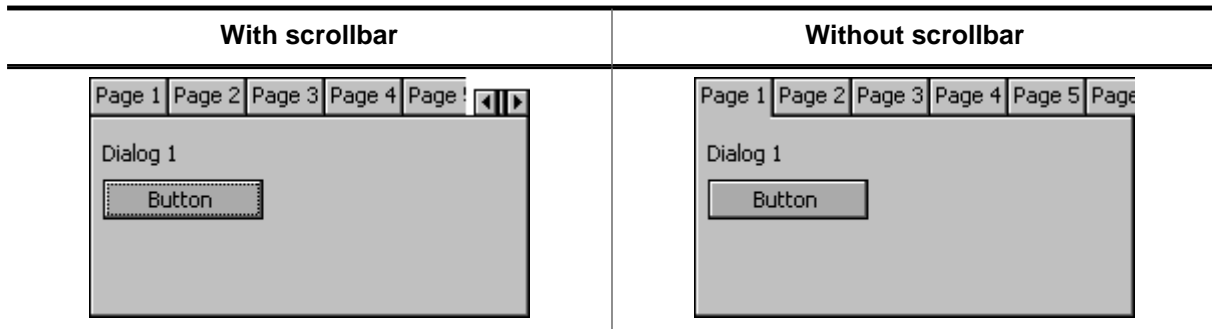

#### Description

Configures the given MULTIPAGE widget to make use of an automatic scroll bar.

#### Prototype

```
void MULTIPAGE_EnableScrollbar(MULTIPAGE_Handle hObj,
                               unsigned         OnOff);
```

#### Parameters

| Parameter          | Description   |
|--------------------|---|
| <code>hObj</code>  | Handle of MULTIPAGE widget.   |
| <code>OnOff</code> | 1 = Enable automatic scroll bar.<br>0 = Disable automatic scroll bar. |

#### Additional information

Calling this function takes effect only before the first page has been added to the widget. The automatic scroll bar is enabled by default.

### 6.2.20.5.1.11 MULTIPAGE\_GetBkColor()

#### Description

Returns the background color of the widget.

#### Prototype

```
GUI_COLOR MULTIPAGE_GetBkColor(MULTIPAGE_Handle hObj,  
                                unsigned Index);
```

#### Parameters

| Parameter             | Description  |
|-----------------------|--|
| <a href="#">hObj</a>  | Handle of MULTIPAGE widget.  |
| <a href="#">Index</a> | See <i>MULTIPAGE color indexes</i> on page 1842 for a full list of permitted values. |

#### Return value

The background color of the given widget.

### 6.2.20.5.1.12 MULTIPAGE\_GetDefaultAlign()

#### Description

Returns the default tab alignment for new MULTIPAGE widgets.

#### Prototype

```
unsigned MULTIPAGE_GetDefaultAlign(void);
```

#### Return value

Default tab alignment for new MULTIPAGE widgets.

#### Additional information

The following table shows the alignment values returned by this function:

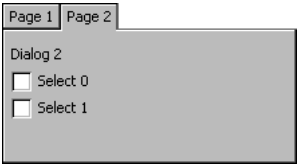
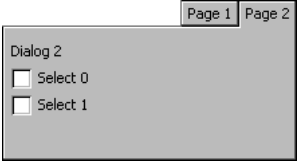
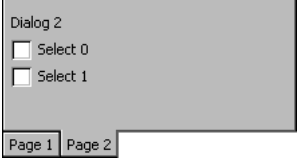
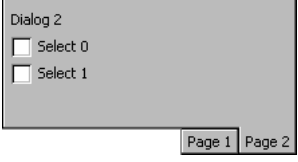
| Alignment                                      | Appearance of MULTIPAGE widget  |
|--|---|
| MULTIPAGE_ALIGN_LEFT   MULTIPAGE_ALIGN_TOP     |    |
| MULTIPAGE_ALIGN_RIGHT   MULTIPAGE_ALIGN_TOP    |   |
| MULTIPAGE_ALIGN_LEFT   MULTIPAGE_ALIGN_BOTTOM  |  |
| MULTIPAGE_ALIGN_RIGHT   MULTIPAGE_ALIGN_BOTTOM |  |

### 6.2.20.5.1.13 MULTIPAGE\_GetDefaultBkColor()

#### Description

Returns the default background color for new MULTIPAGE widgets.

#### Prototype

```
GUI_COLOR MULTIPAGE_GetDefaultBkColor(unsigned Index);
```

#### Parameters

| Parameter             | Description  |
|-----------------------|--|
| <a href="#">Index</a> | See <i>MULTIPAGE color indexes</i> on page 1842 for a full list of permitted values. |

#### Return value

Default background color for new MULTIPAGE widgets.

#### 6.2.20.5.1.14 MULTIPAGE\_GetDefaultFont()

##### Description

Returns a pointer to the font used to display the text in the tabs of new MULTIPAGE widgets.

##### Prototype

```
GUI_FONT *MULTIPAGE_GetDefaultFont(void);
```

##### Return value

Pointer to the font used to display the text in the tabs of new MULTIPAGE widgets.

### 6.2.20.5.1.15 MULTIPAGE\_GetDefaultTextColor()

#### Description

Returns the default text color used to display the text in the tabs of new MULTIPAGE widgets.

#### Prototype

```
GUI_COLOR MULTIPAGE_GetDefaultTextColor(unsigned Index);
```

#### Parameters

| Parameter             | Description  |
|-----------------------|--|
| <a href="#">Index</a> | See <i>MULTIPAGE color indexes</i> on page 1842 for a full list of permitted values. |

#### Return value

Default text color used to display the text in the tabs of new MULTIPAGE widgets.

### 6.2.20.5.1.16 MULTIPAGE\_GetFont()

#### Description

Returns the font of the widget.

#### Prototype

```
GUI_FONT *MULTIPAGE_GetFont(MULTIPAGE_Handle hObj);
```

#### Parameters

| Parameter            | Description                 |
|----------------------|-----------------------------|
| <a href="#">hObj</a> | Handle of MULTIPAGE widget. |

#### Return value

A pointer to the font of the given widget.

### 6.2.20.5.1.17 MULTIPAGE\_GetNumTabs()

#### Description

Returns the number of all tabs in a MULTIPAGE widget.

#### Prototype

```
int MULTIPAGE_GetNumTabs(MULTIPAGE_Handle hObj);
```

#### Parameters

| Parameter            | Description                 |
|----------------------|-----------------------------|
| <a href="#">hObj</a> | Handle of MULTIPAGE widget. |

#### Return value

Number of all tabs in a MULTIPAGE widget.



### 6.2.20.5.1.18 MULTIPAGE\_GetPageText()

#### Description

Returns the text of the given page.

#### Prototype

```
int MULTIPAGE_GetPageText (MULTIPAGE_Handle hObj,  
                           unsigned Index,  
                           char * pBuffer,  
                           int MaxLen);
```

#### Parameters

| Parameter               | Description   |
|-------------------------|---|
| <a href="#">hObj</a>    | Handle of MULTIPAGE widget.                             |
| <a href="#">Index</a>   | <a href="#">Index</a> of the page.                      |
| <a href="#">pBuffer</a> | User defined buffer which is filled with the page text. |
| <a href="#">MaxLen</a>  | Maximum length of the text to be copied.                |

#### Return value

Length of the copied text.

### 6.2.20.5.1.19 MULTIPAGE\_GetSelection()

#### Description

Returns the zero based index of the currently selected page of a MULTIPAGE widget.

#### Prototype

```
int MULTIPAGE_GetSelection(MULTIPAGE_Handle hObj);
```

#### Parameters

| Parameter            | Description                 |
|----------------------|-----------------------------|
| <a href="#">hObj</a> | Handle of MULTIPAGE widget. |

#### Return value

Zero-based index of the currently selected page of a MULTIPAGE widget.

### 6.2.20.5.1.20 MULTIPAGE\_GetTabHeight()

#### Description

Returns the height for all tabs.

#### Prototype

```
int MULTIPAGE_GetTabHeight(MULTIPAGE_Handle hObj);
```

#### Parameters

| Parameter            | Description                 |
|----------------------|-----------------------------|
| <a href="#">hObj</a> | Handle of MULTIPAGE widget. |

#### Return value

Height for all tabs in a MULTIPAGE widget.

### 6.2.20.5.1.21 MULTIPAGE\_GetTabWidth()

#### Description

Returns the width for the given tab.

#### Prototype

```
int MULTIPAGE_GetTabWidth(MULTIPAGE_Handle hObj,  
                          int Index);
```

#### Parameters

| Parameter             | Description                       |
|-----------------------|-----------------------------------|
| <a href="#">hObj</a>  | Handle of MULTIPAGE widget.       |
| <a href="#">Index</a> | <a href="#">Index</a> of the tab. |

#### Return value

Width of a specific tab in a MULTIPAGE widget.

### 6.2.20.5.1.22 MULTIPAGE\_GetTextColor()

#### Description

Returns the text color of the widget.

#### Prototype

```
GUI_COLOR MULTIPAGE_GetTextColor(MULTIPAGE_Handle hObj,  
                                unsigned          Index);
```

#### Parameters

| Parameter             | Description  |
|-----------------------|--|
| <a href="#">hObj</a>  | Handle of MULTIPAGE widget.  |
| <a href="#">Index</a> | See <i>MULTIPAGE color indexes</i> on page 1842 for a full list of permitted values. |

#### Return value

The text color of the given widget.

### 6.2.20.5.1.23 MULTIPAGE\_GetUserData()

#### Description

Prototype explained at the beginning of the chapter as `<WIDGET>_GetUserData()` on page 994.

### 6.2.20.5.1.24 MULTIPAGE\_GetWindow()

#### Description

Returns the handle of the window displayed in the given page.

#### Prototype

```
WM_HWIN MULTIPAGE_GetWindow(MULTIPAGE_Handle hObj,  
                             unsigned Index);
```

#### Parameters

| Parameter             | Description                 |
|-----------------------|-----------------------------|
| <a href="#">hObj</a>  | Handle of MULTIPAGE widget. |
| <a href="#">Index</a> | Zero-based index of page.   |

#### Return value

Handle of the window displayed in the given page.

### 6.2.20.5.1.25 MULTIPAGE\_IsPageEnabled()

#### Description

Returns if the given page of a MULTIEDIT widget is enabled or not.

#### Prototype

```
int MULTIPAGE_IsPageEnabled(MULTIPAGE_Handle hObj,  
                           unsigned Index);
```

#### Parameters

| Parameter             | Description                         |
|-----------------------|-------------------------------------|
| <a href="#">hObj</a>  | Handle of MULTIPAGE widget.         |
| <a href="#">Index</a> | Zero-based index of requested page. |

#### Return value

- 1 if the given page is enabled.
- 0 if the given page is disabled.



### 6.2.20.5.1.26 MULTIPAGE\_SelectPage()

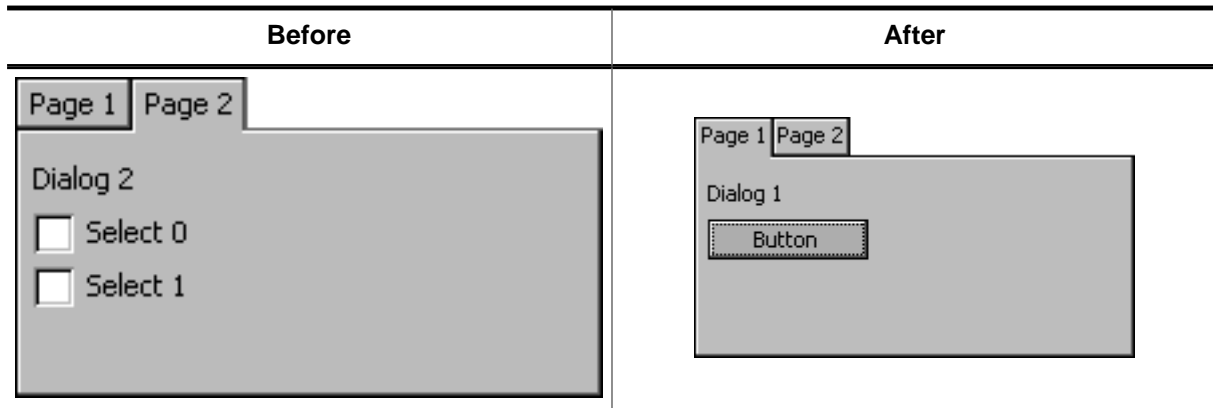

#### Description

Sets the currently selected page of a MULTIPAGE widget.

#### Prototype

```
void MULTIPAGE_SelectPage(MULTIPAGE_Handle hObj,
                          unsigned         Index);
```

#### Parameters

| Parameter          | Description                              |
|--------------------|--|
| <code>hObj</code>  | Handle of MULTIPAGE widget.              |
| <code>Index</code> | Zero-based index of page to be selected. |

### 6.2.20.5.1.27 MULTIPAGE\_SetAlign()

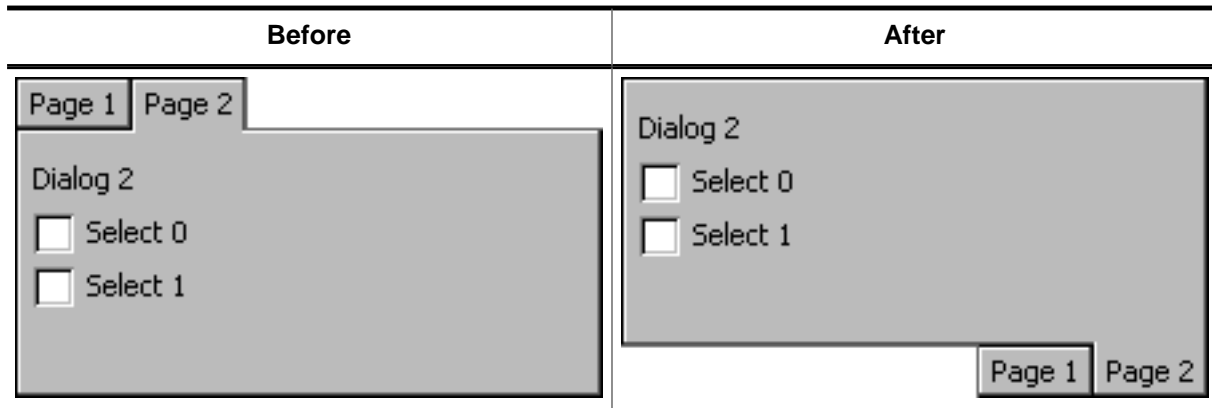

#### Description

Sets the tab alignment for the given MULTIPAGE widget.

#### Prototype

```
void MULTIPAGE_SetAlign(MULTIPAGE_Handle hObj,
                        unsigned          Align);
```

#### Parameters

| Parameter          | Description  |
|--------------------|--|
| <code>hObj</code>  | Handle of MULTIPAGE widget.  |
| <code>Align</code> | See <i>MULTIPAGE alignment flags</i> on page 1840 for a full list of permitted values. |

#### Additional information

For more information, refer to `MULTIPAGE_GetDefaultAlign()`.

### 6.2.20.5.1.28 MULTIPAGE\_SetBitmap()

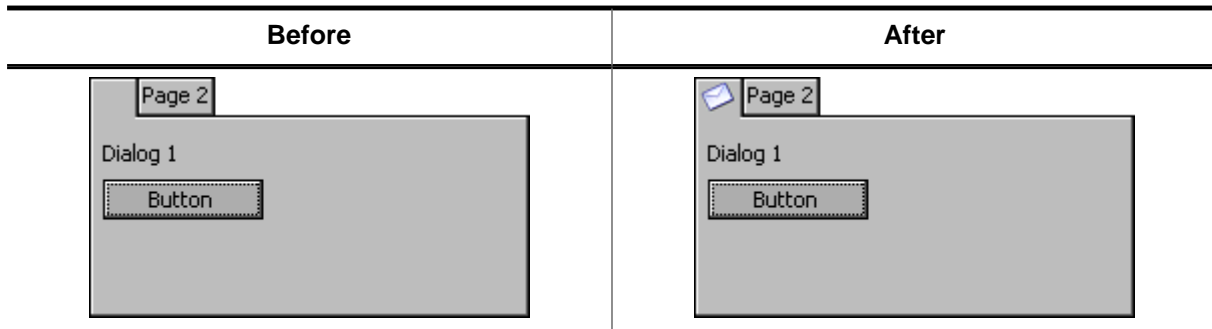

#### Description

Sets a bitmap to be displayed on the given tab. The bitmap is horizontally and vertically aligned to the center of the tab.

#### Prototype

```
int MULTIPAGE_SetBitmap(    MULTIPAGE_Handle  hObj,
                           const GUI_BITMAP  * pBitmap,
                           int               Index,
                           int               State);
```

#### Parameters

| Parameter            | Description  |
|----------------------|--|
| <code>hObj</code>    | Handle of MULTIPAGE widget.  |
| <code>pBitmap</code> | Pointer to the bitmap to be used for the given tab.  |
| <code>Index</code>   | <code>Index</code> of the tab.   |
| <code>State</code>   | <code>State</code> of the tab for which the bitmap has to be used. See <i>MULTIPAGE bitmap indexes</i> on page 1841 for a full list of permitted values. |

#### Return value

0        on success  
1        on error.

### 6.2.20.5.1.29 MULTIPAGE\_SetBitmapEx()

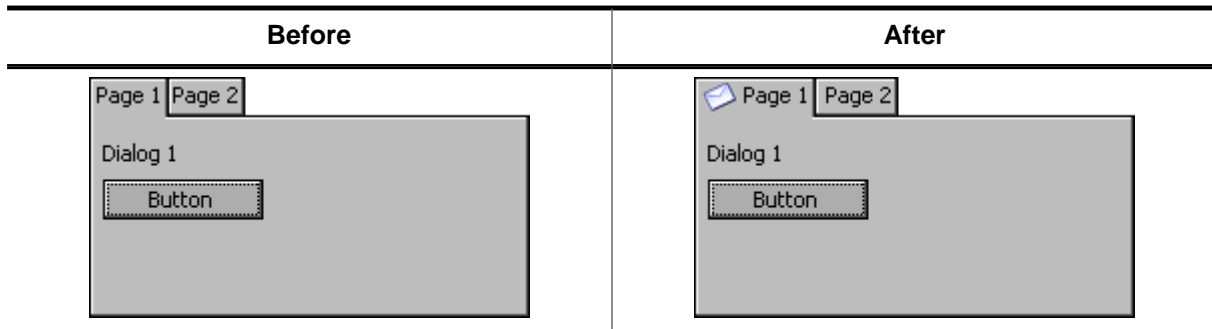

#### Description

Sets a bitmap to be displayed on the given tab adjusting the position from the center to the right, left, top and bottom according to the *x* and *y* values.

#### Prototype

```
int MULTIPAGE_SetBitmapEx(    MULTIPAGE_Handle  hObj,
                             const GUI_BITMAP    * pBitmap,
                             int                 x,
                             int                 y,
                             int                 Index,
                             int                 State);
```

#### Parameters

| Parameter      | Description  |
|----------------|--|
| <i>hObj</i>    | Handle of the MULTIPAGE widget.  |
| <i>pBitmap</i> | Pointer to the bitmap to be used for the given tab.  |
| <i>x</i>       | Adjustment value for the <i>x</i> position of the bitmap. 0 means horizontally centered.   |
| <i>y</i>       | Adjustment value for the <i>y</i> position of the bitmap. 0 means vertically centered.   |
| <i>Index</i>   | <i>Index</i> of the tab.   |
| <i>State</i>   | <i>State</i> of the tab for which the bitmap has to be used. See <i>MULTIPAGE bitmap indexes</i> on page 1841 for a full list of permitted values. |

#### Return value

0        on success  
1        on error.

### 6.2.20.5.1.30 MULTIPAGE\_SetBkColor()

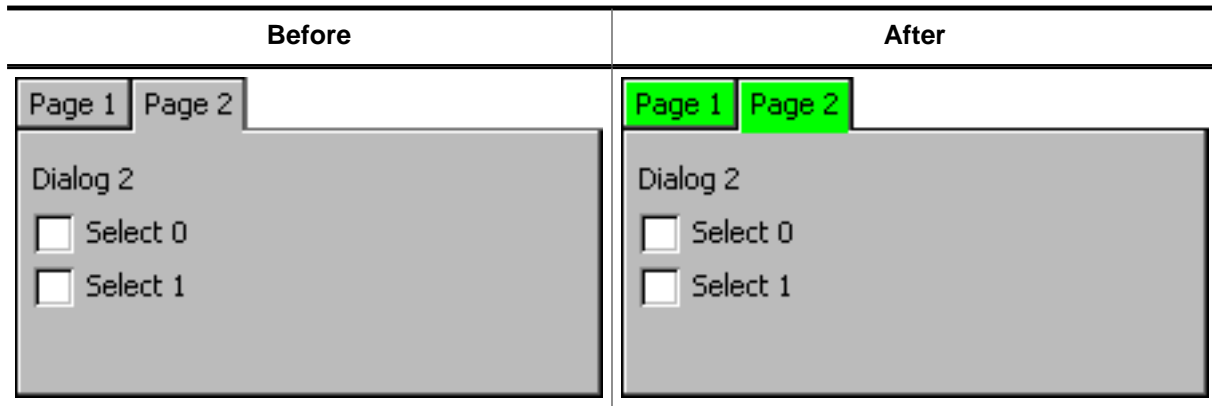

#### Description

Sets the background color of the given MULTIPAGE widget.

#### Prototype

```
void MULTIPAGE_SetBkColor(MULTIPAGE_Handle hObj,
                          GUI_COLOR       Color,
                          unsigned        Index);
```

#### Parameters

| Parameter          | Description  |
|--------------------|--|
| <code>hObj</code>  | Handle of MULTIPAGE widget.  |
| <code>Color</code> | <code>Color</code> to be used.   |
| <code>Index</code> | See <i>MULTIPAGE color indexes</i> on page 1842 for a full list of permitted values. |

#### Additional information

The function only sets the background color for the MULTIPAGE widget. The child windows added to the widget are not affected. That means if the complete client area is drawn by windows added to the widget, only the background color of the tabs changes.

### 6.2.20.5.1.31 MULTIPAGE\_SetDefaultAlign()

#### Description

Sets the default tab alignment for new MULTIPAGE widgets.

#### Prototype

```
void MULTIPAGE_SetDefaultAlign(unsigned Align);
```

#### Parameters

| Parameter             | Description                                   |
|-----------------------|---|
| <a href="#">Align</a> | Tab alignment used for new MULTIPAGE widgets. |

#### Additional information

For more information about the tab alignment, refer to `MULTIPAGE_GetDefaultAlign()` and `MULTIPAGE_SetAlign()`.

### 6.2.20.5.1.32 MULTIPAGE\_SetDefaultBkColor()

#### Description

Sets the default background color used for new MULTIPAGE widgets.

#### Prototype

```
void MULTIPAGE_SetDefaultBkColor(GUI_COLOR Color,  
                                unsigned Index);
```

#### Parameters

| Parameter | Description  |
|-----------|--|
| Color     | Color to be used.  |
| Index     | See <i>MULTIPAGE color indexes</i> on page 1842 for a full list of permitted values. |

### 6.2.20.5.1.33 MULTIPAGE\_SetDefaultBorderSizeX()

#### Description

Sets the default border size on the x-axis.

#### Prototype

```
void MULTIPAGE_SetDefaultBorderSizeX(unsigned Size);
```

#### Parameters

| Parameter | Description             |
|-----------|-------------------------|
| Size      | Border size to be used. |



### 6.2.20.5.1.34 MULTIPAGE\_SetDefaultBorderSizeY()

#### Description

Sets the default border size on the y-axis.

#### Prototype

```
void MULTIPAGE_SetDefaultBorderSizeY(unsigned Size);
```

#### Parameters

| Parameter | Description             |
|-----------|-------------------------|
| Size      | Border size to be used. |

### 6.2.20.5.1.35 MULTIPAGE\_SetDefaultFont()

#### Description

Sets the default font used to display the text in the tabs of new MULTIPAGE widgets.

#### Prototype

```
void MULTIPAGE_SetDefaultFont(const GUI_FONT * pFont);
```

#### Parameters

| Parameter          | Description                               |
|--------------------|---|
| <code>pFont</code> | Pointer to GUI_FONT structure to be used. |

#### Additional information

The horizontal and vertical size of the tabs depends on the size of the used font.

### 6.2.20.5.1.36 MULTIPAGE\_SetDefaultTextColor()

#### Description

Sets the default text color used to display the text in the tabs of new MULTIPAGE widgets.

#### Prototype

```
void MULTIPAGE_SetDefaultTextColor(GUI_COLOR Color,  
                                  unsigned Index);
```

#### Parameters

| Parameter | Description  |
|-----------|--|
| Color     | Color to be used.  |
| Index     | See <i>MULTIPAGE color indexes</i> on page 1842 for a full list of permitted values. |

### 6.2.20.5.1.37 MULTIPAGE\_SetFont()

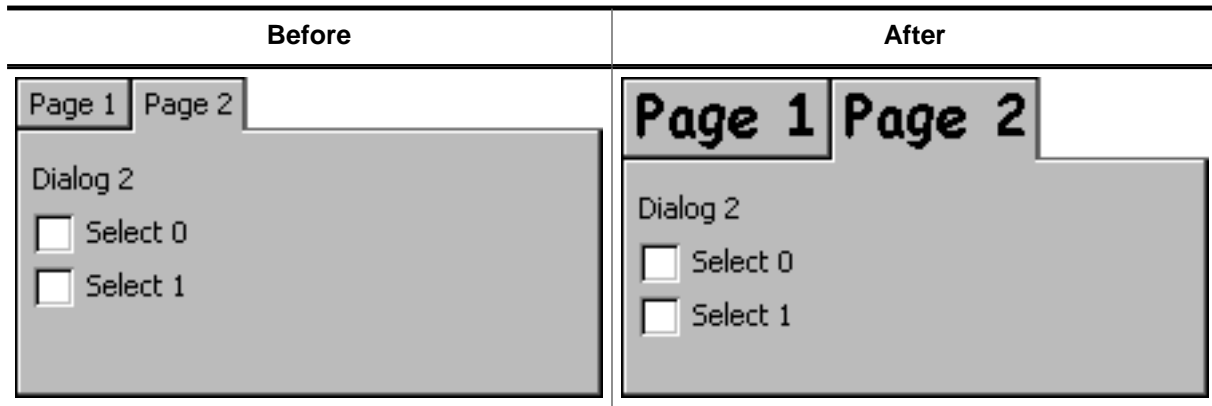

#### Description

Sets the font used to display the text in the tabs of a given MULTIPAGE widget.

#### Prototype

```
void MULTIPAGE_SetFont(      MULTIPAGE_Handle  hObj,
                           const GUI_FONT      * pFont);
```

#### Parameters

| Parameter          | Description   |
|--------------------|---|
| <code>hObj</code>  | Handle of MULTIPAGE widget.   |
| <code>pFont</code> | Pointer to GUI_FONT structure used to display the text in the tabs. |

#### Additional information

The vertical and horizontal size of the tabs depend on the size of the used font and the text shown in the tabs.

### 6.2.20.5.1.38 MULTIPAGE\_SetRotation()

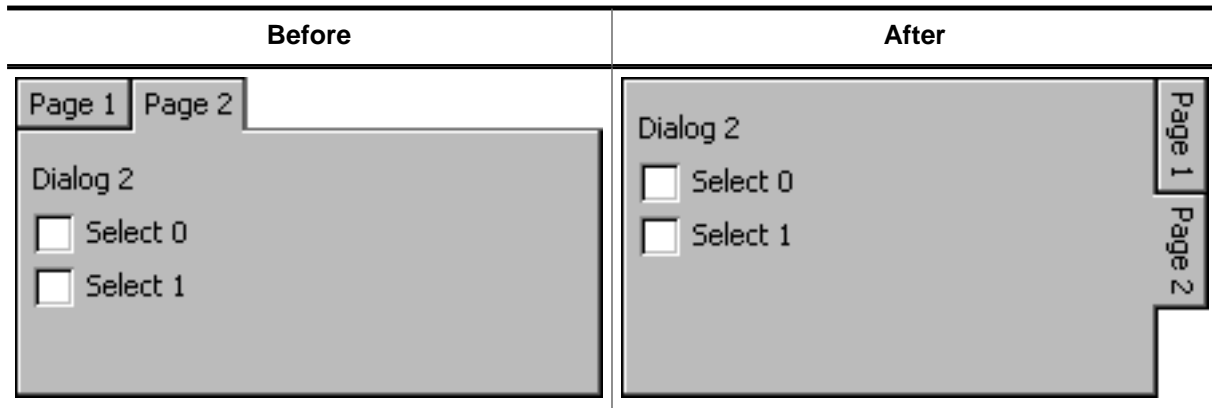

#### Description

Sets the rotation mode of the given widget.

#### Prototype

```
void MULTIPAGE_SetRotation(MULTIPAGE_Handle hObj,
                          unsigned Rotation);
```

#### Parameters

| Parameter             | Description   |
|-----------------------|---|
| <code>hObj</code>     | Handle of MULTIPAGE widget.   |
| <code>Rotation</code> | <code>Rotation</code> mode. See <i>MULTIPAGE create flags</i> on page 1843. |

### 6.2.20.5.1.39 MULTIPAGE\_SetTabHeight()

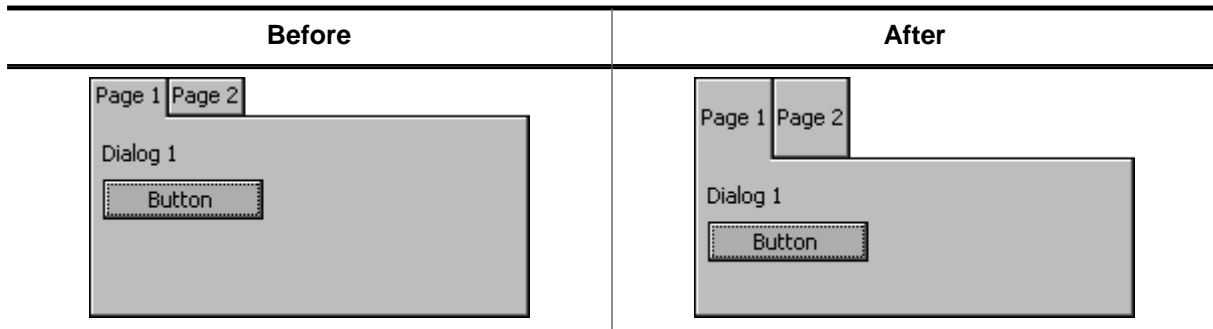

#### Description

Sets the height for all tabs.

#### Prototype

```
void MULTIPAGE_SetTabHeight(MULTIPAGE_Handle hObj,
                           int Height);
```

#### Parameters

| Parameter | Description                 |
|-----------|-----------------------------|
| hObj      | Handle of MULTIPAGE widget. |
| Height    | Height to be set.           |

### 6.2.20.5.1.40 MULTIPAGE\_SetTabWidth()

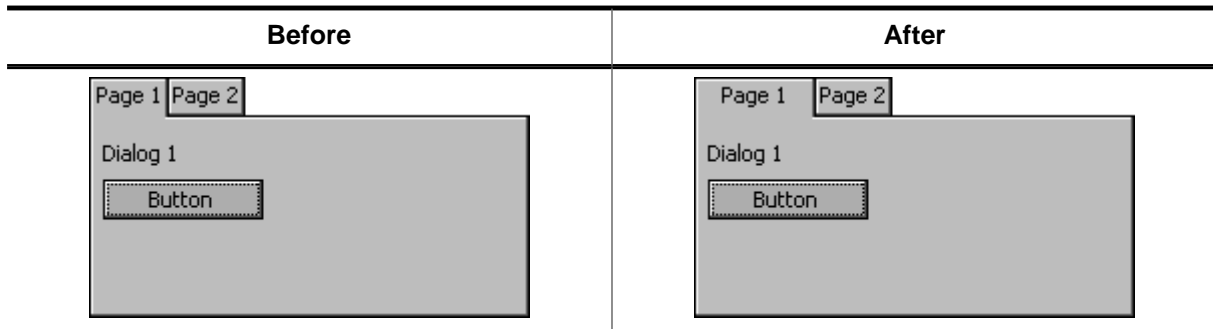

#### Description

Sets the width for the given tab.

#### Prototype

```
void MULTIPAGE_SetTabWidth(MULTIPAGE_Handle hObj,
                           int             Width,
                           int             Index);
```

#### Parameters

| Parameter          | Description                    |
|--------------------|--------------------------------|
| <code>hObj</code>  | Handle of MULTIPAGE widget.    |
| <code>Width</code> | <code>Width</code> to be set.  |
| <code>Index</code> | <code>Index</code> of the tab. |

### 6.2.20.5.1.41 MULTIPAGE\_SetText()

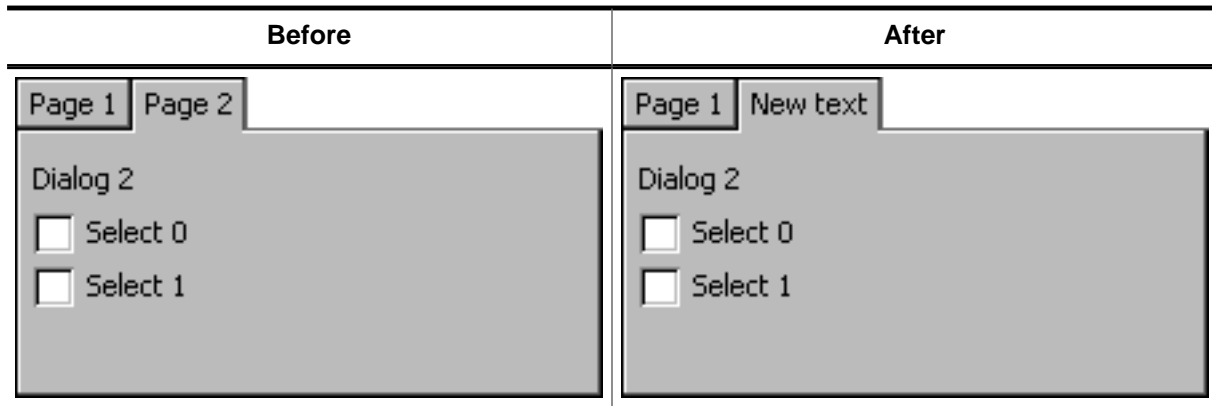

#### Description

Sets the text displayed in the tab of a given page.

#### Prototype

```
void MULTIPAGE_SetText(      MULTIPAGE_Handle  hObj,
                           const char          * s,
                           unsigned           Index);
```

#### Parameters

| Parameter          | Description                          |
|--------------------|--------------------------------------|
| <code>hObj</code>  | Handle of MULTIPAGE widget.          |
| <code>pText</code> | Pointer to the text to be displayed. |
| <code>Index</code> | Zero based index of the page.        |



### 6.2.20.5.1.42 MULTIPAGE\_SetTextAlign()

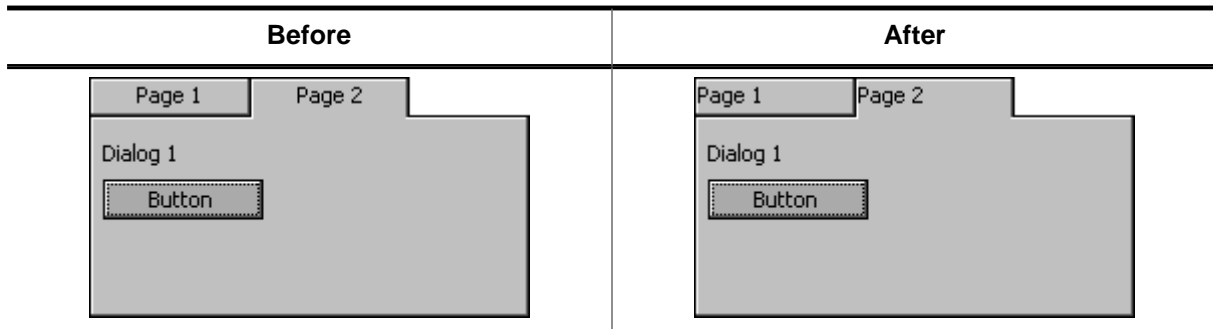

#### Description

Sets the text alignment for the given MULTIPAGE widget.

#### Prototype

```
void MULTIPAGE_SetTextAlign(MULTIPAGE_Handle hObj,
                           unsigned         Align);
```

#### Parameters

| Parameter          | Description                      |
|--------------------|----------------------------------|
| <code>hObj</code>  | Handle of MULTIPAGE widget.      |
| <code>Align</code> | Text alignment. See table below. |

#### Additional information

Setting the text alignment can have a visual impact only in case the tab width was changed. Otherwise the width is set according to the width of the text.

### 6.2.20.5.1.43 MULTIPAGE\_SetTextColor()

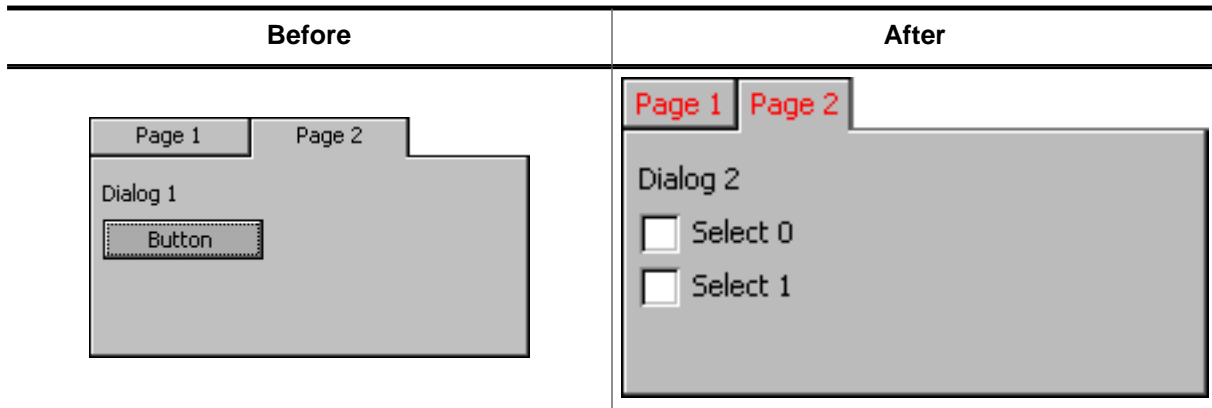

#### Description

Sets the color used to display the text in the tabs of a MULTIPAGE widget.

#### Prototype

```
void MULTIPAGE_SetTextColor(MULTIPAGE_Handle hObj,
                           GUI_COLOR       Color,
                           unsigned        Index);
```

#### Parameters

| Parameter          | Description  |
|--------------------|--|
| <code>hObj</code>  | Handle of MULTIPAGE widget.  |
| <code>Color</code> | <code>Color</code> to be used.   |
| <code>Index</code> | See <i>MULTIPAGE color indexes</i> on page 1842 for a full list of permitted values. |

#### Additional information

Setting the text alignment can have a visual impact only in case the tab width was changed. Otherwise the width is set according to the width of the text.

#### 6.2.20.5.1.44 MULTIPAGE\_SetUserData()

##### Description

Prototype explained at the beginning of the chapter as `<WIDGET>_SetUserData()` on page 995.

## 6.2.20.5.2 Defines

### 6.2.20.5.2.1 MULTIPAGE alignment flags

#### Description

These flags are used by `MULTIPAGE_SetAlign()` and define the tab alignment of a MULTIPAGE widget. Horizontal and vertical flags are OR-combinable.

#### Definition

```
#define MULTIPAGE_ALIGN_LEFT      (0 << 0)
#define MULTIPAGE_ALIGN_RIGHT    (1 << 0)
#define MULTIPAGE_ALIGN_TOP      (0 << 2)
#define MULTIPAGE_ALIGN_BOTTOM  (1 << 2)
```

#### Symbols

| Definition                          | Description                                  |
|-------------------------------------|--|
| <code>MULTIPAGE_ALIGN_LEFT</code>   | Aligns the tabs at the left side.            |
| <code>MULTIPAGE_ALIGN_RIGHT</code>  | Aligns the tabs at the right side.           |
| <code>MULTIPAGE_ALIGN_TOP</code>    | Aligns the tabs at the top of the widget.    |
| <code>MULTIPAGE_ALIGN_BOTTOM</code> | Aligns the tabs at the bottom of the widget. |

### 6.2.20.5.2.2 MULTIPAGE bitmap indexes

#### Description

Bitmap indexes used by the MULTIPAGE widget.

#### Definition

```
#define MULTIPAGE_BI_SELECTED      0
#define MULTIPAGE_BI_UNSELECTED   1
#define MULTIPAGE_BI_DISABLED     2
```

#### Symbols

| Definition                              | Description       |
|---|-------------------|
| <a href="#">MULTIPAGE_BI_SELECTED</a>   | Selected state.   |
| <a href="#">MULTIPAGE_BI_UNSELECTED</a> | Unselected state. |
| <a href="#">MULTIPAGE_BI_DISABLED</a>   | Disabled state.   |

### 6.2.20.5.2.3 MULTIPAGE color indexes

#### Description

Color indexes used by the MULTIPAGE widget.

#### Definition

```
#define MULTIPAGE_CI_DISABLED    0
#define MULTIPAGE_CI_ENABLED    1
```

#### Symbols

| Definition                            | Description               |
|---------------------------------------|---------------------------|
| <a href="#">MULTIPAGE_CI_DISABLED</a> | Color for disabled pages. |
| <a href="#">MULTIPAGE_CI_ENABLED</a>  | Color for enabled pages.  |

#### 6.2.20.5.2.4 MULTIPAGE create flags

##### Description

Create flags used when creating a MULTIPAGE widget or when using the routine `MULTIPAGE_SetRotation()`.

##### Definition

```
#define MULTIPAGE_CF_ROTATE_CW    (1 << 3)
```

##### Symbols

| Definition                          | Description  |
|-------------------------------------|--|
| <code>MULTIPAGE_CF_ROTATE_CW</code> | Arranges the tabs at the vertical side and rotates the tab text by 90 degrees clockwise. |

##### Note

When specifying **0** instead of a flag, the widget is displayed in default horizontal mode.

## 6.2.20.6 Example

The `Sample` folder contains the following example which shows how the widget can be used:

- `WIDGET_Multipage.c`

Note that several other examples also make use of this widget and may also be helpful to get familiar with the widget.

### Screenshot of `WIDGET_Multipage.c`

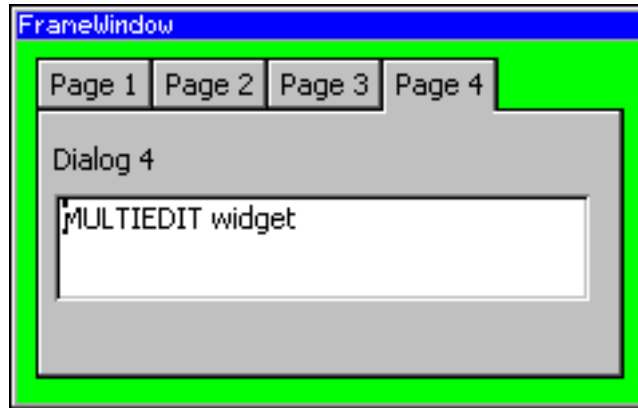



## 6.2.21 PROGBAR: Progress bar widget

PROGBAR widgets are commonly used in applications for visualization; for example, a tank fill-level indicator or an oil-pressure indicator. Example screenshots can be found at the beginning of the chapter and at end of this section.

### Note

All PROGBAR-related routines are in the file(s) `PROGBAR*.c`, `PROGBAR.h`. All identifiers are prefixed `PROGBAR`.

### Skinning...

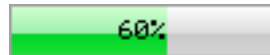

...is available for this widget. The screenshot above shows the widget using the default skin. Details can be found in the chapter *Skinning* on page 2509.

### 6.2.21.1 Configuration options

| Type | Macro                                   | Default                               | Description            |
|------|---|---------------------------------------|------------------------|
| S    | <code>PROGBAR_DEFAULT_FONT</code>       | <code>GUI_DEFAULT_FONT</code>         | Font used.             |
| N    | <code>PROGBAR_DEFAULT_BARCOLOR0</code>  | <code>0x555555</code><br>(dark gray)  | Left bar color.        |
| N    | <code>PROGBAR_DEFAULT_BARCOLOR1</code>  | <code>0xAAAAAA</code><br>(light gray) | Right bar color.       |
| N    | <code>PROGBAR_DEFAULT_TEXTCOLOR0</code> | <code>0xFFFFFFFF</code>               | Text color, left bar.  |
| N    | <code>PROGBAR_DEFAULT_TEXTCOLOR1</code> | <code>0x000000</code>                 | Text color, right bar. |

### 6.2.21.2 Predefined IDs

The following symbols define IDs which may be used to make PROGBAR widgets distinguishable from creation.

```
#define GUI_ID_PROGBAR0    0x210
#define GUI_ID_PROGBAR1    0x211
#define GUI_ID_PROGBAR2    0x212
#define GUI_ID_PROGBAR3    0x213
#define GUI_ID_PROGBAR4    0x214
#define GUI_ID_PROGBAR5    0x215
#define GUI_ID_PROGBAR6    0x216
#define GUI_ID_PROGBAR7    0x217
#define GUI_ID_PROGBAR8    0x218
#define GUI_ID_PROGBAR9    0x219
```

### 6.2.21.3 Notification codes

The following events are sent from a PROGBAR widget to its parent window as part of a `WM_NOTIFY_PARENT` message:

| Message                                    | Description                              |
|--|--|
| <code>WM_NOTIFICATION_VALUE_CHANGED</code> | Value of the PROGBAR widget has changed. |

### 6.2.21.4 Keyboard reaction

The widget can not gain the input focus and does not react on keyboard input.

## 6.2.21.5 PROGBAR API

The table below lists the available emWin PROGBAR-related routines in alphabetical order. Detailed descriptions of the routines follow.

### Functions

| Routine                               | Description  |
|---------------------------------------|--|
| <code>PROGBAR_Create()</code>         | Creates a PROGBAR widget. (Obsolete)                             |
| <code>PROGBAR_CreateAsChild()</code>  | Creates a PROGBAR widget as a child window. (Obsolete)           |
| <code>PROGBAR_CreateEx()</code>       | Creates a PROGBAR widget.  |
| <code>PROGBAR_CreateIndirect()</code> | Creates a PROGBAR widget from resource table entry.              |
| <code>PROGBAR_CreateUser()</code>     | Creates a PROGBAR widget using extra bytes as user data.         |
| <code>PROGBAR_GetBarColor()</code>    | Returns the color(s) of the PROGBAR widget.                      |
| <code>PROGBAR_GetFont()</code>        | Returns the font of the PROGBAR widget.                          |
| <code>PROGBAR_GetMinMax()</code>      | Returns the minimum and maximum values of the PROGBAR.           |
| <code>PROGBAR_GetTextColor()</code>   | Returns the text color(s) of the PROGBAR widget.                 |
| <code>PROGBAR_GetUserData()</code>    | Retrieves the data set with <code>PROGBAR_SetUserData()</code> . |
| <code>PROGBAR_GetValue()</code>       | Returns the current value of the given PROGBAR widget.           |
| <code>PROGBAR_SetBarColor()</code>    | Sets the color(s) of the PROGBAR widget.                         |
| <code>PROGBAR_SetFont()</code>        | Select the font for the text.                                    |
| <code>PROGBAR_SetMinMax()</code>      | Set the minimum and maximum values used for the bar.             |
| <code>PROGBAR_SetText()</code>        | Sets the text displayed inside the PROGBAR widget.               |
| <code>PROGBAR_SetTextAlign()</code>   | Sets the text alignment.   |
| <code>PROGBAR_SetTextColor()</code>   | Sets the text color of the PROGBAR widget.                       |
| <code>PROGBAR_SetTextPos()</code>     | Sets the text position in pixels.                                |
| <code>PROGBAR_SetUserData()</code>    | Sets the extra data of a PROGBAR widget.                         |
| <code>PROGBAR_SetValue()</code>       | Sets the value of the PROGBAR widget.                            |

### Defines

| Group of defines                  | Description                              |
|-----------------------------------|--|
| <code>PROGBAR create flags</code> | Create flags used by the PROGBAR widget. |

## 6.2.21.5.1 Functions

### 6.2.21.5.1.1 PROGBAR\_Create()

#### Note

This function is **deprecated**, `PROGBAR_CreateEx()` should be used instead.

#### Description

Creates a PROGBAR widget of a specified size at a specified location.

#### Prototype

```
PROGBAR_Handle PROGBAR_Create(int x0,
                              int y0,
                              int xSize,
                              int ySize,
                              int Flags);
```

#### Parameters

| Parameter          | Description  |
|--------------------|--|
| <code>x0</code>    | Leftmost pixel of the PROGBAR widget (in parent coordinates).  |
| <code>y0</code>    | Topmost pixel of the PROGBAR widget (in parent coordinates).   |
| <code>xSize</code> | Horizontal size of the PROGBAR widget (in pixels).   |
| <code>ySize</code> | Vertical size of the PROGBAR widget (in pixels).   |
| <code>Flags</code> | Window create flags. Typically <code>WM_CF_SHOW</code> in order to make the widget visible immediately (refer to <i>Window create flags</i> on page 977 for a list of available parameter values). |

#### Return value

Handle of the created PROGBAR widget; 0 if the function fails.

### 6.2.21.5.1.2 PROGBAR\_CreateAsChild()

#### Note

This function is **deprecated**, `PROGBAR_CreateEx()` should be used instead.

#### Description

Creates a PROGBAR widget as a child window.

#### Prototype

```
PROGBAR_Handle PROGBAR_CreateAsChild(int    x0,
                                       int    y0,
                                       int    xSize,
                                       int    ySize,
                                       WM_HWIN hParent,
                                       int    Id,
                                       int    Flags);
```

#### Parameters

| Parameter            | Description   |
|----------------------|---|
| <code>x0</code>      | X-position of the PROGBAR widget relative to the parent window.   |
| <code>y0</code>      | Y-position of the PROGBAR widget relative to the parent window.   |
| <code>xSize</code>   | Horizontal size of the PROGBAR widget (in pixels).                |
| <code>ySize</code>   | Vertical size of the PROGBAR widget (in pixels).                  |
| <code>hParent</code> | Handle of parent window.  |
| <code>Id</code>      | ID to be returned.  |
| <code>Flags</code>   | Window create flags (see <i>Window create flags</i> on page 977). |

#### Return value

Handle of the created PROGBAR widget; 0 if the function fails.

### 6.2.21.5.1.3 PROGBAR\_CreateEx()

#### Description

Creates a PROGBAR widget of a specified size at a specified location.

#### Prototype

```
PROGBAR_Handle PROGBAR_CreateEx(int    x0,
                                int    y0,
                                int    xSize,
                                int    ySize,
                                WM_HWIN hParent,
                                int    WinFlags,
                                int    ExFlags,
                                int    Id);
```

#### Parameters

| Parameter             | Description  |
|-----------------------|--|
| <code>x0</code>       | Leftmost pixel of the PROGBAR widget (in parent coordinates).  |
| <code>y0</code>       | Topmost pixel of the PROGBAR widget (in parent coordinates).   |
| <code>xSize</code>    | Horizontal size of the PROGBAR widget (in pixels).   |
| <code>ySize</code>    | Vertical size of the PROGBAR widget (in pixels).   |
| <code>hParent</code>  | Handle of parent window. If 0, the new PROGBAR widget will be a child of the desktop (top-level window).   |
| <code>WinFlags</code> | Window create flags. Typically <code>WM_CF_SHOW</code> in order to make the widget visible immediately (refer to <i>Window create flags</i> on page 977 for a list of available parameter values). |
| <code>ExFlags</code>  | See <i>PROGBAR create flags</i> on page 1867.  |
| <code>Id</code>       | Window ID of the PROGBAR widget.   |

#### Return value

Handle of the created PROGBAR widget; 0 if the function fails.

#### 6.2.21.5.1.4 PROGBAR\_CreateIndirect()

##### Description

The prototype of this function is explained at the beginning of this chapter. Details can be found in the description of the function `<WIDGET>_CreateIndirect()` on page 992. The element `Para` of the according `GUI_WIDGET_CREATE_INFO` structure is not used. The element `Flags` is used according to the parameter `ExFlags` of the function `PROGBAR_CreateEx()`.

### 6.2.21.5.1.5 PROGBAR\_CreateUser()

#### Description

Prototype explained at the beginning of the chapter as `<WIDGET>_CreateUser()` on page 993. For a detailed description of the parameters the function `PROGBAR_CreateEx()` can be referred to.

### 6.2.21.5.1.6 PROGBAR\_GetBarColor()

#### Description

Returns the color(s) of the PROGBAR widget.

#### Prototype

```
GUI_COLOR PROGBAR_GetBarColor(PROGBAR_Handle hObj,
                               unsigned int  Index);
```

#### Parameters

| Parameter             | Description                                      |
|-----------------------|--|
| <a href="#">hObj</a>  | Handle of PROGBAR widget.                        |
| <a href="#">Index</a> | See table below. Other values are not permitted. |

| Permitted values for parameter <a href="#">Index</a> |  |
|--|--|
| 0  | Left/lower portion of the PROGBAR widget.  |
| 1  | Right/upper portion of the PROGBAR widget. |

#### Return value

The color(s) of the PROGBAR widget.



### 6.2.21.5.1.7 PROGBAR\_GetFont()

#### Description

Returns the font of the PROGBAR widget.

#### Prototype

```
GUI_FONT *PROGBAR_GetFont(PROGBAR_Handle hObj);
```

#### Parameters

| Parameter            | Description               |
|----------------------|---------------------------|
| <a href="#">hObj</a> | Handle of PROGBAR widget. |

#### Return value

The font of the PROGBAR widget.

### 6.2.21.5.1.8 PROGBAR\_GetMinMax()

#### Description

Copies the minimum value and maximum value of the given PROGBAR widget to the given integer pointers.

#### Prototype

```
void PROGBAR_GetMinMax(PROGBAR_Handle  hObj,  
                       int             * pMin,  
                       int             * pMax);
```

#### Parameters

| Parameter            | Description   |
|----------------------|---|
| <a href="#">hObj</a> | Handle of PROGBAR widget.                                 |
| <a href="#">pMin</a> | Minimum value (Range: $-16383 < \text{Min} \leq 16383$ ). |
| <a href="#">pMax</a> | Maximum value (Range: $-16383 < \text{Max} \leq 16383$ ). |

### 6.2.21.5.1.9 PROGBAR\_GetTextColor()

#### Description

Returns the text color(s) of the PROGBAR widget.

#### Prototype

```
GUI_COLOR PROGBAR_GetTextColor(PROGBAR_Handle hObj,
                                unsigned int   Index);
```

#### Parameters

| Parameter             | Description                                      |
|-----------------------|--|
| <a href="#">hObj</a>  | Handle of PROGBAR widget.                        |
| <a href="#">Index</a> | See table below. Other values are not permitted. |

| Permitted values for parameter <a href="#">Index</a> |                                  |
|--|----------------------------------|
| 0  | Left/lower portion of the text.  |
| 1  | Right/upper portion of the text. |

#### Return value

The text color(s) of the PROGBAR widget.

### 6.2.21.5.1.10 PROGBAR\_GetUserData()

#### Description

Prototype explained at the beginning of the chapter as `<WIDGET>_GetUserData()` on page 994.

### 6.2.21.5.1.11 PROGBAR\_GetValue()

#### Description

Returns the current value of the given PROGBAR widget.

#### Prototype

```
int PROGBAR_GetValue(PROGBAR_Handle hObj);
```

#### Parameters

| Parameter            | Description               |
|----------------------|---------------------------|
| <a href="#">hObj</a> | Handle of PROGBAR widget. |

#### Return value

Current value of the PROGBAR widget.

### 6.2.21.5.1.12 PROGBAR\_SetBarColor()

#### Description

Sets the color(s) of the PROGBAR widget.

#### Prototype

```
void PROGBAR_SetBarColor(PROGBAR_Handle hObj,
                        unsigned int   Index,
                        GUI_COLOR      color);
```

#### Parameters

| Parameter             | Description                                      |
|-----------------------|--|
| <a href="#">hObj</a>  | Handle of PROGBAR widget.                        |
| <a href="#">Index</a> | See table below. Other values are not permitted. |
| <a href="#">Color</a> | <a href="#">Color</a> to set (24-bit RGB value). |

| Permitted values for parameter <a href="#">Index</a> |  |
|--|--|
| 0  | Left/lower portion of the PROGBAR widget.  |
| 1  | Right/upper portion of the PROGBAR widget. |

### 6.2.21.5.1.13 PROGBAR\_SetFont()

#### Description

Selects the font for the text display inside the PROGBAR widget.

#### Prototype

```
void PROGBAR_SetFont(      PROGBAR_Handle  hObj,
                          const GUI_FONT  * pfont);
```

#### Parameters

| Parameter          | Description                                      |
|--------------------|--|
| <code>hObj</code>  | Handle of PROGBAR widget.                        |
| <code>Index</code> | See table below. Other values are not permitted. |
| <code>Color</code> | <code>Color</code> to set (24-bit RGB value).    |

#### Additional information

If this function is not called, the default font for PROGBAR widgets (the GUI default font) will be used. However, the default font of the PROGBAR widget may be changed in the `GUIConf.h` file. Simply define the default font as follows (example):

```
#define PROGBAR_DEFAULT_FONT &GUI_Font13_ASCII
```

### 6.2.21.5.1.14 PROGBAR\_SetMinMax()

#### Description

Sets the minimum and maximum values used for the PROGBAR widget.

#### Prototype

```
void PROGBAR_SetMinMax(PROGBAR_Handle hObj,  
                        int           Min,  
                        int           Max);
```

#### Parameters

| Parameter            | Description   |
|----------------------|---|
| <a href="#">hObj</a> | Handle of PROGBAR widget.                                 |
| <a href="#">Min</a>  | Minimum value (Range: $-16383 < \text{Min} \leq 16383$ ). |
| <a href="#">Max</a>  | Maximum value (Range: $-16383 < \text{Max} \leq 16383$ ). |

#### Additional information

If this function is not called, the default values of [Min](#) = 0, [Max](#) = 100 will be used.



### 6.2.21.5.1.15 PROGBAR\_SetText()

#### Description

Sets the text displayed inside the PROGBAR widget.

#### Prototype

```
void PROGBAR_SetText(      PROGBAR_Handle  hObj,  
                          const char      * s);
```

#### Parameters

| Parameter         | Description   |
|-------------------|---|
| <code>hObj</code> | Handle of PROGBAR widget.   |
| <code>s</code>    | Text to display. A <code>NULL</code> pointer is permitted; in this case a percentage value will be displayed. |

#### Additional information

If this function is not called, a percentage value will be displayed as the default. If you do not want to display any text at all, you should set an empty string.

### 6.2.21.5.1.16 PROGBAR\_SetTextAlign()

#### Description

Sets the text alignment.

#### Prototype

```
void PROGBAR_SetTextAlign(PROGBAR_Handle hObj,  
                           int           Align);
```

#### Parameters

| Parameter             | Description   |
|-----------------------|---|
| <a href="#">hObj</a>  | Handle of PROGBAR widget.   |
| <a href="#">Align</a> | See <i>Text alignment flags</i> on page 252. <b>Only horizontal flags are applicable!</b> |

#### Additional information

If this function is not called, the default behavior is to display the text centered.

### 6.2.21.5.1.17 PROGBAR\_SetTextColor()

#### Description

Sets the text color of the PROGBAR widget.

#### Prototype

```
void PROGBAR_SetTextColor(PROGBAR_Handle hObj,
                          unsigned int   Index,
                          GUI_COLOR      color);
```

#### Parameters

| Parameter             | Description                                      |
|-----------------------|--|
| <a href="#">hObj</a>  | Handle of PROGBAR widget.                        |
| <a href="#">Index</a> | See table below. Other values are not permitted. |
| <a href="#">Color</a> | <a href="#">Color</a> to set (24-bit RGB value). |

| Permitted values for parameter <a href="#">Index</a> |                            |
|--|----------------------------|
| 0  | Left portion of the text.  |
| 1  | Right portion of the text. |

### 6.2.21.5.1.18 PROGBAR\_SetTextPos()

#### Description

Sets the text position in pixels.

#### Prototype

```
void PROGBAR_SetTextPos(PROGBAR_Handle hObj,  
                        int             XOff,  
                        int             YOff);
```

#### Parameters

| Parameter         | Description   |
|-------------------|---|
| <code>hObj</code> | Handle of PROGBAR widget.   |
| <code>XOff</code> | Number of pixels to move text in horizontal direction. Positive number will move text to the right. |
| <code>YOff</code> | Number of pixels to move text in vertical direction. Positive number will move text down.           |

#### Additional information

The values move the text the specified number of pixels within the widget. Normally, the default of (0,0) should be sufficient.

### 6.2.21.5.1.19 PROGBAR\_SetUserData()

#### Description

Prototype explained at the beginning of the chapter as `<WIDGET>_SetUserData()` on page 995.

### 6.2.21.5.1.20 PROGBAR\_SetValue()

#### Description

Sets the value of the PROGBAR widget.

#### Prototype

```
void PROGBAR_SetValue(PROGBAR_Handle hObj,  
                      int v);
```

#### Parameters

| Parameter         | Description               |
|-------------------|---------------------------|
| <code>hObj</code> | Handle of PROGBAR widget. |
| <code>v</code>    | Value to set.             |

#### Additional information

The bar indicator will be calculated with regard to the max/min values. If a percentage is automatically displayed, the percentage will also be calculated using the given min/max values as follows:

$$p = 100\% * (v - \text{Min}) / (\text{Max} - \text{Min})$$

The default value after creation of the widget is 0.

## 6.2.21.5.2 Defines

### 6.2.21.5.2.1 PROGBAR create flags

#### Description

Create flags used for the PROGBAR widget. These flags are specified when creating the widget with `PROGBAR_CreateEx()`.

#### Definition

```
#define PROGBAR_CF_HORIZONTAL (0 << 0)
#define PROGBAR_CF_VERTICAL (1 << 0)
```

#### Symbols

| Definition                         | Description   |
|------------------------------------|---|
| <code>PROGBAR_CF_VERTICAL</code>   | A vertical PROGBAR widget will be created. Vertical PROGBAR widgets do not show any text. |
| <code>PROGBAR_CF_HORIZONTAL</code> | A horizontal PROGBAR widget will be created (default).                                    |

## 6.2.21.6 Examples

The `Sample` folder contains the following examples which show how the widget can be used:

- `WIDGET_SimpleProgbar.c`
- `WIDGET_Progbar.c`

Note that several other examples also make use of this widget and may also be helpful to get familiar with the widget.

### Screenshot of `WIDGET_SimpleProgbar.c`

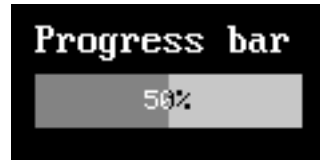

### Screenshot of `WIDGET_Progbar.c`





## 6.2.22 QRCODE: QR code widget

The QRCODE widget is used for displaying QR codes. The widget draws a QR code with the given parameters and also adds a white frame around the code which is necessary for scanning.

### Note

All QRCODE-related routines are located in the file(s) `QRCODE.c`, `QRCODE.h`.



### 6.2.22.1 Configuration options

| Type | Macro                  | Default   | Description                                    |
|------|------------------------|-----------|--|
| N    | QRCODE_COLOR_DEFAULT   | GUI_WHITE | Default color to draw the bright pixels.       |
| N    | QRCODE_BKCOLOR_DEFAULT | GUI_BLACK | Default default color to draw the dark pixels. |

### 6.2.22.2 Predefined IDs

The following symbols define IDs which may be used to make QRCODE widgets distinguishable from creation.

```
#define GUI_ID_QRCODE0    0x350
#define GUI_ID_QRCODE1    0x351
#define GUI_ID_QRCODE2    0x352
#define GUI_ID_QRCODE3    0x353
#define GUI_ID_QRCODE4    0x354
#define GUI_ID_QRCODE5    0x355
#define GUI_ID_QRCODE6    0x356
#define GUI_ID_QRCODE7    0x357
#define GUI_ID_QRCODE8    0x358
#define GUI_ID_QRCODE9    0x359
```

### 6.2.22.3 Keyboard reaction

The widget can not gain the input focus and does not react on keyboard input.

## 6.2.22.4 QR CODE API

The table below lists the available emWin QR CODE-related routines in alphabetical order. Detailed descriptions of the routines follow.

### Functions

| Routine                                  | Description  |
|--|--|
| <a href="#">QR_CODE_CreateIndirect()</a> | Creates a QR CODE widget from a resource table entry.        |
| <a href="#">QR_CODE_CreateUser()</a>     | Creates a QR CODE widget.                                    |
| <a href="#">QR_CODE_SetEccLevel()</a>    | Sets the error correction level of a QR CODE widget.         |
| <a href="#">QR_CODE_SetVersion()</a>     | Sets the version of the QR code.                             |
| <a href="#">QR_CODE_SetPixelSize()</a>   | Sets the size of one pixel in the QR CODE widget.            |
| <a href="#">QR_CODE_SetText()</a>        | Sets the text to be used to draw the QR CODE widget.         |
| <a href="#">QR_CODE_SetWiFiText()</a>    | Sets the text of a QR CODE widget told hold WiFi login data. |

### Defines

| Group of defines                              | Description                                |
|---|--|
| <a href="#">QR_CODE_WiFi_encryption_types</a> | Macros for WiFi password encryption types. |

## 6.2.22.4.1 Functions

### 6.2.22.4.1.1 QRCODE\_CreateIndirect()

#### Description

The prototype of this function is explained at the beginning of this chapter. Details can be found in the description of the function `<WIDGET>_CreateIndirect()` on page 992. The elements `Flags` and `Para` of the resource passed as parameter are not used.

### 6.2.22.4.1.2 QRCODE\_CreateUser()

#### Description

Creates a QRCODE widget.

#### Prototype

```
QRCODE_Handle QRCODE_CreateUser(    int        x0,
                                     int        y0,
                                     int        xSize,
                                     int        ySize,
                                     WM_HWIN   hParent,
                                     U32       WinFlags,
                                     int        ExFlags,
                                     int        Id,
    const char * pText,
                                     int        PixelSize,
                                     int        EccLevel,
                                     int        Version,
                                     int        NumExtraBytes);
```

#### Parameters

| Parameter                  | Description  |
|----------------------------|--|
| <code>x0</code>            | Leftmost pixel of the QRCODE widget (in parent coordinates).   |
| <code>y0</code>            | Topmost pixel of the QRCODE widget (in parent coordinates).  |
| <code>xSize</code>         | Horizontal size of the QRCODE widget (in pixels).  |
| <code>ySize</code>         | Vertical size of the QRCODE widget (in pixels).  |
| <code>hParent</code>       | Parent window of the QRCODE widget.  |
| <code>WinFlags</code>      | Window create flags. Typically <code>WM_CF_SHOW</code> in order to make the widget visible immediately (refer to <i>Window create flags</i> on page 977 for a list of available parameter values).   |
| <code>ExFlags</code>       | Not used yet, reserved for future use.   |
| <code>Id</code>            | ID of the QRCODE widget.   |
| <code>pText</code>         | UTF-8 text to be used for the QR-code.   |
| <code>PixelSize</code>     | Size in pixels of one 'Module'.  |
| <code>EccLevel</code>      | Error correction level to be used. See full list of available values under <i>ECC levels for QR codes</i> on page 423.   |
| <code>NumModules</code>    | Desired size in modules of the QR-code. If set to 0 (recommended) the size will be calculated automatically. Must be between 1 and 40. If it is less than required for the given text with the given <code>EccLevel</code> , the function fails. |
| <code>NumExtraBytes</code> | Number of extra bytes to be allocated.   |

#### Return value

Handle of the QRCODE widget.

### 6.2.22.4.1.3 QRCODE\_SetEccLevel()

#### Description

Sets the error correction level of a QRCODE widget.

#### Prototype

```
void QRCODE_SetEccLevel(QRCODE_Handle hObj,  
                        int EccLevel);
```

#### Parameters

| Parameter             | Description  |
|-----------------------|--|
| <code>hObj</code>     | Handle of QRCODE widget.   |
| <code>EccLevel</code> | Error correction level to be used. See full list of available values under <i>ECC levels for QR codes</i> on page 423. |

#### 6.2.22.4.1.4 QRCODE\_SetVersion()

##### Description

Sets the version of the QR code. The version indicates the size of the total code.

##### Prototype

```
void QRCODE_SetVersion(QRCODE_Handle hObj,  
                       int           Version);
```

##### Parameters

| Parameter            | Description   |
|----------------------|---|
| <code>hObj</code>    | Handle of QRCODE widget.  |
| <code>Version</code> | Should be between 1 and 40. If set to 0, the size will be calculated automatically. |

### 6.2.22.4.1.5 QRCODE\_SetPixelSize()

#### Description

Sets the size of one pixel in the QRCODE widget.

#### Prototype

```
void QRCODE_SetPixelSize(QRCODE_Handle hObj,  
                          int          PixelSize);
```

#### Parameters

| Parameter              | Description                   |
|------------------------|-------------------------------|
| <code>hObj</code>      | Handle of QRCODE widget.      |
| <code>PixelSize</code> | Size of one pixel to be used. |

### 6.2.22.4.1.6 QRCODE\_SetText()

#### Description

Sets the text to be used to draw the QRCODE widget.

#### Prototype

```
void QRCODE_SetText(      QRCODE_Handle  hObj,  
                        const char      * pText);
```

#### Parameters

| Parameter          | Description                     |
|--------------------|---------------------------------|
| <code>hObj</code>  | Handle of QRCODE widget.        |
| <code>pText</code> | Text to be used for the widget. |



### 6.2.22.4.1.7 QRCODE\_SetWiFiText()

#### Description

Sets the text of a QRCODE widget told hold WiFi login data. When scanning the QR code with a smartphone, the phone will try to log into the specified WiFi network.

#### Prototype

```
void QRCODE_SetWiFiText(    QRCODE_Handle  hObj,
                           const char      * pSSID,
                           U8              Encryption,
                           const char      * pPassword,
                           U8              Hidden);
```

#### Parameters

| Parameter                  | Description   |
|----------------------------|---|
| <a href="#">hObj</a>       | Handle of QRCODE widget.                              |
| <a href="#">pSSID</a>      | SSID of the network.                                  |
| <a href="#">Encryption</a> | See <i>QRCODE WiFi encryption types</i> on page 1878. |
| <a href="#">pPassword</a>  | Password of the network.                              |
| <a href="#">Hidden</a>     | 0 if the network is not hidden, 1 if it is hidden.    |

## 6.2.22.4.2 Defines

### 6.2.22.4.2.1 QRCODE WiFi encryption types

#### Description

These macros are to be used for the [Encryption](#) parameter of `QRCODE_SetWiFiText()`.

#### Definition

```
#define QRCODE_WIFI_WPA    0
#define QRCODE_WIFI_WEP    1
```

#### Symbols

| Definition                      | Description                            |
|---------------------------------|--|
| <a href="#">QRCODE_WIFI_WPA</a> | If the WiFi password is WPA encrypted. |
| <a href="#">QRCODE_WIFI_WEP</a> | If the WiFi password is WEP encrypted. |

## 6.2.23 RADIO: Radio button widget

Radio buttons, like check boxes, are used for selecting choices. A dot appears when a RADIO button is turned on or selected. The difference from check boxes is that the user can only select one RADIO button at a time. When a button is selected, the other buttons in the widget are turned off, as shown to the right. One RADIO button widget may contain any number of buttons, which are always arranged vertically.

### Note

All RADIO-related routines are located in the file(s) `RADIO*.c`, `RADIO.h`. All identifiers are prefixed `RADIO`.

The table below shows the classic appearances of a RADIO widget. The default appearance of the widget uses the newer skin, as seen below the table.

|                   | Enabled                                       | Disabled                                      |
|-------------------|---|---|
| <b>Selected</b>   | <input checked="" type="radio"/> Radio button | <input checked="" type="radio"/> Radio button |
| <b>Unselected</b> | <input type="radio"/> Radio button            | <input type="radio"/> Radio button            |

### Skinning...

- Option 1
- Option 2
- Option 3

...is available for this widget. The screenshot above shows the widget using the default skin. Details can be found in the chapter *Skinning* on page 2509.

### 6.2.23.1 Configuration options

| Type | Macro                                  | Default                        | Description   |
|------|--|--------------------------------|---|
| S    | <code>RADIO_IMAGE0_DEFAULT</code>      | (see table above)              | Default outer image used to show a disabled RADIO button.             |
| S    | <code>RADIO_IMAGE1_DEFAULT</code>      | (see table above)              | Default outer image used to show a enabled RADIO button.              |
| S    | <code>RADIO_IMAGE_CHECK_DEFAULT</code> | (see table above)              | Default inner image used to mark the selected item.                   |
| N    | <code>RADIO_FONT_DEFAULT</code>        | <code>&amp;GUI_Font13_1</code> | Default font used to render the text of the RADIO widget.             |
| N    | <code>RADIO_DEFAULT_TEXT_COLOR</code>  | <code>GUI_BLACK</code>         | Default text color of RADIO widget.                                   |
| N    | <code>RADIO_DEFAULT_BKCOLOR</code>     | <code>0xC0C0C0</code>          | Default background color of RADIO buttons if no transparency is used. |
| N    | <code>RADIO_FOCUSCOLOR_DEFAULT</code>  | <code>GUI_BLACK</code>         | Default color for rendering the focus rectangle.                      |

### 6.2.23.2 Predefined IDs

The following symbols define IDs which may be used to make RADIO widgets distinguishable from creation.

```
#define GUI_ID_RADIO0    0x150
#define GUI_ID_RADIO1    0x151
#define GUI_ID_RADIO2    0x152
#define GUI_ID_RADIO3    0x153
#define GUI_ID_RADIO4    0x154
#define GUI_ID_RADIO5    0x155
#define GUI_ID_RADIO6    0x156
#define GUI_ID_RADIO7    0x157
#define GUI_ID_RADIO8    0x158
#define GUI_ID_RADIO9    0x159
```

### 6.2.23.3 Notification codes

The following events are sent from a RADIO widget to its parent window as part of a WM\_NOTIFY\_PARENT message:

| Message                       | Description   |
|-------------------------------|---|
| WM_NOTIFICATION_CLICKED       | RADIO button has been clicked.  |
| WM_NOTIFICATION_RELEASED      | RADIO button has been released.   |
| WM_NOTIFICATION_MOVED_OUT     | RADIO button has been clicked and pointer has been moved out of the button without releasing. |
| WM_NOTIFICATION_VALUE_CHANGED | Value (selection) of the RADIO widget has changed.  |

### 6.2.23.4 Keyboard reaction

The widget reacts to the following keys if it has the input focus:

| Key           | Reaction                       |
|---------------|--------------------------------|
| GUI_KEY_RIGHT | Increments the selection by 1. |
| GUI_KEY_DOWN  | Increments the selection by 1. |
| GUI_KEY_LEFT  | Decrements the selection by 1. |
| GUI_KEY_UP    | Decrements the selection by 1. |

## 6.2.23.5 RADIO API

The table below lists the available emWin RADIO-related routines in alphabetical order. Detailed descriptions of the routines follow.

### Functions

| Routine                                   | Description   |
|---|---|
| <code>RADIO_Create()</code>               | Creates a RADIO widget. (Obsolete)  |
| <code>RADIO_CreateEx()</code>             | Creates a RADIO widget.   |
| <code>RADIO_CreateIndirect()</code>       | Creates a RADIO widget from resource table entry.   |
| <code>RADIO_CreateUser()</code>           | Creates a RADIO widget using extra bytes as user data.                                      |
| <code>RADIO_Dec()</code>                  | Decrements the selection by 1.  |
| <code>RADIO_GetBkColor()</code>           | Returns the background color of the RADIO widget.   |
| <code>RADIO_GetDefaultFont()</code>       | Returns the default font used to display the optional text next to new RADIO buttons.       |
| <code>RADIO_GetDefaultTextColor()</code>  | Returns the default text color used to display the optional text next to new RADIO buttons. |
| <code>RADIO_GetFocusColor()</code>        | Returns the color used to render the focus rectangle of the RADIO button.                   |
| <code>RADIO_GetFont()</code>              | Returns the font set for this widget.   |
| <code>RADIO_GetImage()</code>             | Returns a pointer to the set image of a RADIO.  |
| <code>RADIO_GetNumItems()</code>          | Returns the number of items in a RADIO widget.  |
| <code>RADIO_GetSpacing()</code>           | Returns the vertical spacing between the items.   |
| <code>RADIO_GetText()</code>              | Returns the optional text of the given RADIO widget.  |
| <code>RADIO_GetTextColor()</code>         | Returns the text color of the RADIO widget.   |
| <code>RADIO_GetUserData()</code>          | Retrieves the data set with <code>RADIO_SetUserData()</code> .                              |
| <code>RADIO_GetValue()</code>             | Returns the currently selected button.  |
| <code>RADIO_Inc()</code>                  | Increments the selection by a value of 1.   |
| <code>RADIO_SetBkColor()</code>           | Sets the background color of the RADIO widget.  |
| <code>RADIO_SetDefaultFocusColor()</code> | Sets the default focus rectangle color for new RADIO buttons.                               |
| <code>RADIO_SetDefaultFont()</code>       | Sets the default font used to display the optional text next to new RADIO buttons.          |
| <code>RADIO_SetDefaultImage()</code>      | Sets the images used to draw new RADIO buttons.   |
| <code>RADIO_SetDefaultTextColor()</code>  | Sets the default text color used to display the optional text next to new RADIO buttons.    |
| <code>RADIO_SetFocusColor()</code>        | Sets the color used to render the focus rectangle of the RADIO button.                      |
| <code>RADIO_SetFont()</code>              | Sets the font used to display the optional text next to the RADIO buttons.                  |
| <code>RADIO_SetGroupId()</code>           | Sets the group ID of the RADIO widget.  |
| <code>RADIO_SetImage()</code>             | Sets the images used to draw the RADIO button.  |
| <code>RADIO_SetSpacing()</code>           | Sets the vertical spacing between the items.  |
| <code>RADIO_SetText()</code>              | Sets the text.  |
| <code>RADIO_SetTextColor()</code>         | Sets the text color used to show the optional text beside the RADIO buttons.                |

| <b>Routine</b>                   | <b>Description</b>                     |
|----------------------------------|--|
| <code>RADIO_SetUserData()</code> | Sets the extra data of a RADIO widget. |
| <code>RADIO_SetValue()</code>    | Sets the current button selection.     |

## Defines

| <b>Group of defines</b>           | <b>Description</b>   |
|-----------------------------------|--|
| <code>RADIO bitmap indexes</code> | Bitmap indexes used for setting the bitmaps of a RADIO widget. |

## 6.2.23.5.1 Functions

### 6.2.23.5.1.1 RADIO\_Create()

#### Note

This function is **deprecated**, `RADIO_CreateEx()` should be used instead.

#### Description

Creates a RADIO widget of a specified size at a specified location.

#### Prototype

```
RADIO_Handle RADIO_Create(int    x0,
                          int    y0,
                          int    xSize,
                          int    ySize,
                          WM_HWIN hParent,
                          int    Id,
                          int    Flags,
                          unsigned Para);
```

#### Parameters

| Parameter            | Description  |
|----------------------|--|
| <code>x0</code>      | Leftmost pixel of the RADIO widget (in parent coordinates).  |
| <code>y0</code>      | Topmost pixel of the RADIO widget (in parent coordinates).   |
| <code>xSize</code>   | Horizontal size of the RADIO widget (in pixels).   |
| <code>ySize</code>   | Vertical size of the RADIO widget (in pixels).   |
| <code>hParent</code> | Handle of parent window.   |
| <code>Id</code>      | ID to be returned.   |
| <code>Flags</code>   | Window create flags. Typically <code>WM_CF_SHOW</code> in order to make the widget visible immediately (refer to <i>Window create flags</i> on page 977 for a list of available parameter values). |
| <code>Para</code>    | Number of buttons in the group.  |
| <code>v</code>       | Value to set.  |

#### Return value

Handle of the created RADIO widget; 0 if the function fails.

### 6.2.23.5.1.2 RADIO\_CreateEx()

#### Description

Creates a RADIO widget of a specified size at a specified location.

#### Prototype

```
RADIO_Handle RADIO_CreateEx(int    x0,
                             int    y0,
                             int    xSize,
                             int    ySize,
                             WM_HWIN hParent,
                             int    WinFlags,
                             int    ExFlags,
                             int    Id,
                             int    NumItems,
                             int    Spacing);
```

#### Parameters

| Parameter             | Description  |
|-----------------------|--|
| <code>x0</code>       | Leftmost pixel of the widget (in parent coordinates).  |
| <code>y0</code>       | Topmost pixel of the widget (in parent coordinates).   |
| <code>xSize</code>    | Horizontal size of the widget (in pixels).   |
| <code>ySize</code>    | Vertical size of the widget (in pixels).   |
| <code>hParent</code>  | Handle of parent window. If 0, the new RADIO widget will be a child of the desktop (top-level window).   |
| <code>WinFlags</code> | Window create flags. Typically <code>WM_CF_SHOW</code> in order to make the widget visible immediately (refer to <i>Window create flags</i> on page 977 for a list of available parameter values). |
| <code>ExFlags</code>  | Not used, reserved for future use.   |
| <code>Id</code>       | Window ID of the widget.   |
| <code>NumItems</code> | Number of items contained by the RADIO widget. (default is 2)  |
| <code>Spacing</code>  | Number of vertical pixels used for each item of the RADIO widget.  |

#### Return value

Handle of the created RADIO widget; 0 if the function fails.

#### Additional information

If creating a RADIO widget make sure, that the given `ySize` is enough to show all items. The value should be at least `NumItems * Spacing`. If the given value of `NumItems` is  $\leq 0$  a default value of 2 is used.



### 6.2.23.5.1.3 RADIO\_CreateIndirect()

#### Description

The prototype of this function is explained at the beginning of this chapter. For details the function `<WIDGET>_CreateIndirect()` on page 992 should be referred to. The element Flags of the according `GUI_WIDGET_CREATE_INFO` structure is not used. The following table shows the use of the element `Para`:

| Bits    | Description   |
|---------|---|
| 0 - 7   | Number of items of the RADIO widget. If 0, a default value of 2 items is used.              |
| 8 - 15  | Number of vertical pixels used for each item. If 0 the height of the default image is used. |
| 16 - 23 | Not used, reserved for future use.  |
| 24 - 31 | Not used, reserved for future use.  |

#### 6.2.23.5.1.4 RADIO\_CreateUser()

##### Description

Prototype explained at the beginning of the chapter as `<WIDGET>_CreateUser()` on page 993. For a detailed description of the parameters the function `RADIO_CreateEx()` can be referred to.

### 6.2.23.5.1.5 RADIO\_Dec()

| Before  | After   |
|---|---|
| <input type="radio"/> Red<br><input checked="" type="radio"/> Green<br><input type="radio"/> Blue | <input checked="" type="radio"/> Red<br><input type="radio"/> Green<br><input type="radio"/> Blue |

#### Description

Decrements the selection by 1.

#### Prototype

```
void RADIO_Dec(RADIO_Handle hObj);
```

#### Parameters

| Parameter         | Description             |
|-------------------|-------------------------|
| <code>hObj</code> | Handle of RADIO widget. |

#### Additional information

Note that the numbering of the buttons always starts from the top with a value of 0; therefore, decrementing the selection will actually move the selection one button up.

### 6.2.23.5.1.6 RADIO\_GetBkColor()

#### Description

Returns the background color of the RADIO widget.

#### Prototype

```
GUI_COLOR RADIO_GetBkColor(RADIO_Handle hObj);
```

#### Parameters

| Parameter            | Description             |
|----------------------|-------------------------|
| <a href="#">hObj</a> | Handle of RADIO widget. |

#### Return value

The background color of the widget.

### 6.2.23.5.1.7 RADIO\_GetDefaultFont()

#### Description

Returns the default font used to display the optional text next to new RADIO buttons.

#### Prototype

```
GUI_FONT *RADIO_GetDefaultFont(void);
```

#### Return value

Default font used to display the optional text next to the RADIO buttons.

#### Additional information

For information about how to add text to a RADIO widget, refer to `RADIO_SetText()`.

### 6.2.23.5.1.8 RADIO\_GetDefaultTextColor()

#### Description

Returns the default text color used to display the optional text next to new RADIO buttons.

#### Prototype

```
GUI_COLOR RADIO_GetDefaultTextColor(void);
```

#### Return value

Default text color used to display the optional text next to new RADIO buttons.

#### Additional information

For information about how to add text to a RADIO widget, refer to `RADIO_SetText()`.

### 6.2.23.5.1.9 RADIO\_GetFocusColor()

#### Description

Returns the color used to render the focus rectangle of the RADIO button.

#### Prototype

```
GUI_COLOR RADIO_GetFocusColor(RADIO_Handle hObj);
```

#### Parameters

| Parameter            | Description             |
|----------------------|-------------------------|
| <a href="#">hObj</a> | Handle of RADIO widget. |

#### Return value

The color of the focus rectangle.

### 6.2.23.5.1.10 RADIO\_GetFont()

#### Description

Returns the font set for this widget.

#### Prototype

```
GUI_FONT *RADIO_GetFont(RADIO_Handle hObj);
```

#### Parameters

| Parameter            | Description             |
|----------------------|-------------------------|
| <a href="#">hObj</a> | Handle of RADIO widget. |

#### Return value

A pointer to the font of the widget.



### 6.2.23.5.1.11 RADIO\_GetImage()

#### Description

Returns a pointer to the set image of a RADIO.

#### Prototype

```
GUI_BITMAP *RADIO_GetImage(RADIO_Handle hObj,  
                           unsigned int Index);
```

#### Parameters

| Parameter             | Description   |
|-----------------------|---|
| <a href="#">hObj</a>  | Handle to RADIO widget.   |
| <a href="#">Index</a> | See <i>RADIO bitmap indexes</i> on page 1915 for a full list of permitted values. |

#### Return value

Pointer to a GUI\_BITMAP structure of the set image.

### 6.2.23.5.1.12 RADIO\_GetNumItems()

#### Description

Returns the number of items in a RADIO widget.

#### Prototype

```
int RADIO_GetNumItems(RADIO_Handle hObj);
```

#### Parameters

| Parameter            | Description             |
|----------------------|-------------------------|
| <a href="#">hObj</a> | Handle of RADIO widget. |

#### Return value

Number of items in the RADIO widget.

### 6.2.23.5.1.13 RADIO\_GetSpacing()

#### Description

Returns the vertical spacing between the items.

#### Prototype

```
U16 RADIO_GetSpacing(RADIO_Handle hObj);
```

#### Parameters

| Parameter            | Description             |
|----------------------|-------------------------|
| <a href="#">hObj</a> | Handle of RADIO widget. |

#### Return value

Vertical spacing between the items.

### 6.2.23.5.1.14 RADIO\_GetText()

#### Description

Returns the optional text of the given RADIO widget.

#### Prototype

```
int RADIO_GetText(RADIO_Handle hObj,  
                 unsigned Index,  
                 char * pBuffer,  
                 int MaxLen);
```

#### Parameters

| Parameter               | Description   |
|-------------------------|---|
| <a href="#">hObj</a>    | Handle of RADIO widget.                             |
| <a href="#">Index</a>   | <a href="#">Index</a> of the desired item.          |
| <a href="#">pBuffer</a> | Pointer to buffer to which the text will be copied. |
| <a href="#">MaxLen</a>  | Buffer size in bytes.                               |

#### Return value

Length of the text copied into the buffer.

#### Additional information

If the desired item of the RADIO widget contains no text the function returns 0 and the buffer remains unchanged.

### 6.2.23.5.1.15 RADIO\_GetTextColor()

#### Description

Returns the text color of the RADIO widget.

#### Prototype

```
GUI_COLOR RADIO_GetTextColor(RADIO_Handle hObj);
```

#### Parameters

| Parameter            | Description             |
|----------------------|-------------------------|
| <a href="#">hObj</a> | Handle of RADIO widget. |

#### Return value

The text color of the widget.

### 6.2.23.5.1.16 RADIO\_GetUserData()

#### Description

Prototype explained at the beginning of the chapter as `<WIDGET>_GetUserData()` on page 994.

### 6.2.23.5.1.17 RADIO\_GetValue()

#### Description

Returns the currently selected button.

#### Prototype

```
int RADIO_GetValue(RADIO_Handle hObj);
```

#### Parameters

| Parameter         | Description             |
|-------------------|-------------------------|
| <code>hObj</code> | Handle of RADIO widget. |

#### Return value

The value of the currently selected button. If no button is selected (in case of using a RADIO button group) the return value is -1.

#### Additional information

For information about how to use groups of RADIO buttons, refer to `RADIO_SetGroupId()`.

### 6.2.23.5.1.18 RADIO\_Inc()

| Before  | After   |
|---|---|
| <input checked="" type="radio"/> Red<br><input type="radio"/> Green<br><input type="radio"/> Blue | <input type="radio"/> Red<br><input checked="" type="radio"/> Green<br><input type="radio"/> Blue |

#### Description

Increments the selection by a value of 1.

#### Prototype

```
void RADIO_Inc(RADIO_Handle hObj);
```

#### Parameters

| Parameter         | Description             |
|-------------------|-------------------------|
| <code>hObj</code> | Handle of RADIO widget. |

#### Additional information

Note that the numbering of the buttons always starts from the top with a value of 0; therefore, incrementing the selection will actually move the selection one button down.



### 6.2.23.5.1.19 RADIO\_SetBkColor()

| Before  | After   |
|---|---|
|  |  |

#### Description

Sets the background color of the RADIO widget.

#### Prototype

```
void RADIO_SetBkColor(RADIO_Handle hObj,
                     GUI_COLOR Color);
```

#### Parameters

| Parameter          | Description   |
|--------------------|---|
| <code>hObj</code>  | Handle of RADIO widget.   |
| <code>Color</code> | <code>Color</code> to be used for the background. (range 0x000000 and 0xFFFFFFFF or a valid color define) <code>GUI_INVALID_COLOR</code> to make background transparent |

#### Additional information

The background of this widget can either be filled with any available color or transparent. If a valid RGB color is specified, the background is filled with the color, otherwise the background (typically the content of the parent window) is visible. If the background is transparent, the widget is treated as transparent window, otherwise as non-transparent window. Note that using a background color allows more efficient (faster) rendering. If skinning is active this function should not be used.

### 6.2.23.5.1.20 RADIO\_SetDefaultFocusColor()

#### Description

Sets the default focus rectangle color for new RADIO buttons.

#### Prototype

```
GUI_COLOR RADIO_SetDefaultFocusColor(GUI_COLOR Color);
```

#### Parameters

| Parameter          | Description  |
|--------------------|--|
| <code>hObj</code>  | Handle of RADIO widget.  |
| <code>Color</code> | <code>Color</code> to be used for the background. (range 0x000000 and 0xFFFFFFFF or a valid color define) GUI_INVALID_COLOR to make background transparent |

#### Return value

Previous default focus rectangle color.

#### Additional information

For more information, refer to `RADIO_SetFocusColor()`.

### 6.2.23.5.1.21 RADIO\_SetDefaultFont()

#### Description

Sets the default font used to display the optional text next to new RADIO buttons.

#### Prototype

```
void RADIO_SetDefaultFont(const GUI_FONT * pFont);
```

#### Parameters

| Parameter          | Description   |
|--------------------|---|
| <code>pFont</code> | Pointer to GUI_FONT structure used to show the text of new RADIO widgets. |

#### Additional information

For information about how to add text to a RADIO widget, refer to `RADIO_SetText()`.

### 6.2.23.5.1.22 RADIO\_SetDefaultImage()

#### Description

Sets the images used to draw new RADIO buttons.

#### Prototype

```
void RADIO_SetDefaultImage(const GUI_BITMAP * pBitmap,
                          unsigned int   Index);
```

#### Parameters

| Parameter            | Description   |
|----------------------|---|
| <code>pBitmap</code> | Pointer to the bitmap.  |
| <code>Index</code>   | See <i>RADIO bitmap indexes</i> on page 1915 for a full list of permitted values. |

#### Additional information

Two images are used to display a RADIO button. One image is used to draw the outer frame used to display a unselected RADIO button. In dependence of the current state it will be the bitmap referenced by `RADIO_BI_ACTIVE` (default) or by `RADIO_BI_ACTIVE`. The second image (referenced by `RADIO_BI_CHECK`) is used to mark the currently selected button.

### 6.2.23.5.1.23 RADIO\_SetDefaultTextColor()

#### Description

Sets the default text color used to display the optional text next to new RADIO buttons.

#### Prototype

```
void RADIO_SetDefaultTextColor(GUI_COLOR TextColor);
```



#### Parameters

| Parameter              | Description           |
|------------------------|-----------------------|
| <code>TextColor</code> | New color to be used. |

#### Additional information

For information about how to add text to a RADIO widget, refer to `RADIO_SetText()`.

### 6.2.23.5.1.24 RADIO\_SetFocusColor()

| Before  | After   |
|---|---|
|  |  |

#### Description

Sets the color used to render the focus rectangle of the RADIO button.

#### Prototype

```
GUI_COLOR RADIO_SetFocusColor(RADIO_Handle hObj,
                               GUI_COLOR   Color);
```

#### Parameters

| Parameter          | Description  |
|--------------------|--|
| <code>hObj</code>  | Handle of RADIO widget.                                |
| <code>Color</code> | <code>Color</code> to be used for the focus rectangle. |



#### Return value

Previous color of the focus rectangle.

#### Additional information

The focus rectangle is only visible if the widget has the input focus.

### 6.2.23.5.1.25 RADIO\_SetFont()

| Before  | After   |
|---|---|
|  |  |

#### Description

Sets the font used to display the optional text next to the RADIO buttons.

#### Prototype

```
void RADIO_SetFont(      RADIO_Handle  hObj,
                       const GUI_FONT  * pFont);
```

#### Parameters

| Parameter          | Description   |
|--------------------|---|
| <code>hObj</code>  | Handle of RADIO widget.                                       |
| <code>pFont</code> | Pointer to GUI_FONT structure to be used to display the text. |

#### Additional information

For information about how to add text to a RADIO widget, refer to `RADIO_SetText()`.

### 6.2.23.5.1.26 RADIO\_SetGroupId()



#### Description

Sets the group ID of the RADIO widget.

#### Prototype

```
void RADIO_SetGroupId(RADIO_Handle hObj,
                    U8 NewGroupId);
```

#### Parameters

| Parameter            | Description  |
|----------------------|--|
| <code>hObj</code>    | Handle of RADIO widget.  |
| <code>GroupId</code> | ID of the RADIO button group. Must be between 1 and 255. If the value is 0 the RADIO widget is not assigned to a RADIO button group. |

#### Additional information

This command can be used to create groups of RADIO buttons. The behavior of one group is the same as the behavior of one RADIO button. This makes it possible to create for example 2 RADIO widgets side by side with 3 buttons each and build one group of them.

#### Example

The following example shows how to create a group of 2 RADIO widgets as shown in the screenshot at the beginning of the function description:

```
hRadio_0 = RADIO_CreateEx(10, 10, 60, 0, WM_HBKWIN, WM_CF_SHOW, 0, 1234, 3, 20);
RADIO_SetText(hRadio_0, "Red", 0);
RADIO_SetText(hRadio_0, "Green", 1);
RADIO_SetText(hRadio_0, "Blue", 2);
hRadio_1 = RADIO_CreateEx(65, 10, 60, 0, WM_HBKWIN, WM_CF_SHOW, 0, 1234, 3, 20);
RADIO_SetText(hRadio_1, "Magenta", 0);
RADIO_SetText(hRadio_1, "Cyan", 1);
RADIO_SetText(hRadio_1, "Yellow", 2);
RADIO_SetGroupId(hRadio_0, 1);
RADIO_SetGroupId(hRadio_1, 1);
```



### 6.2.23.5.1.27 RADIO\_SetImage()

#### Description

Sets the images used to draw the RADIO button.

#### Prototype

```
void RADIO_SetImage(      RADIO_Handle  hObj,  
                        const GUI_BITMAP * pBitmap,  
                        unsigned int    Index);
```

#### Parameters

| Parameter               | Description                                   |
|-------------------------|---|
| <a href="#">hObj</a>    | Handle of RADIO widget.                       |
| <a href="#">pBitmap</a> | Pointer to the bitmap.                        |
| <a href="#">Index</a>   | See <i>RADIO bitmap indexes</i> on page 1915. |

#### Additional information

See `RADIO_SetDefaultImage()`.

### 6.2.23.5.1.28 RADIO\_SetSpacing()

#### Description

Sets the vertical spacing between the items.

#### Prototype

```
void RADIO_SetSpacing(RADIO_Handle hObj,  
                     U16          Spacing);
```

#### Parameters

| Parameter               | Description                                      |
|-------------------------|--|
| <a href="#">hObj</a>    | Handle of RADIO widget.                          |
| <a href="#">Spacing</a> | <a href="#">Spacing</a> between items in pixels. |

### 6.2.23.5.1.29 RADIO\_SetText()

#### Description

Sets the optional text shown next to the RADIO buttons.

#### Prototype

```
void RADIO_SetText(      RADIO_Handle  hObj,
                        const char    * s,
                        unsigned      Index);
```

#### Parameters

| Parameter          | Description   |
|--------------------|---|
| <code>hObj</code>  | Handle of RADIO widget.   |
| <code>pText</code> | Pointer to the text to be shown next to the specified RADIO button. |
| <code>Index</code> | Zero based index of the RADIO button.                               |



#### Additional information



If using a RADIO widget without text (old style) the focus rectangle is drawn around the buttons of the widget. If using RADIO button text the focus rectangle is shown around the text of the currently selected RADIO button of the widget.

#### Example

The following example shows how to add the text shown in the screenshot above:

```
RADIO_SetText(hRadio_0, "Red", 0);
RADIO_SetText(hRadio_0, "Green", 1);
RADIO_SetText(hRadio_0, "Blue", 2);
```

### 6.2.23.5.1.30 RADIO\_SetTextColor()

| Before  | After   |
|---|---|
|  |  |

#### Description

Sets the text color used to show the optional text beside the RADIO buttons.

#### Prototype

```
void RADIO_SetTextColor(RADIO_Handle hObj,
                       GUI_COLOR   Color);
```

#### Parameters

| Parameter          | Description                               |
|--------------------|---|
| <code>hObj</code>  | Handle of RADIO widget.                   |
| <code>Color</code> | <code>Color</code> used to show the text. |

#### Additional information

For information about how to add text to a RADIO widget, refer to `RADIO_SetText()`.

### 6.2.23.5.1.31 RADIO\_SetUserData()

#### Description

Prototype explained at the beginning of the chapter as `<WIDGET>_SetUserData()` on page 995.

### 6.2.23.5.1.32 RADIO\_SetValue()

#### Description

Sets the current button selection.

#### Prototype

```
void RADIO_SetValue(RADIO_Handle hObj,  
                   int           v);
```

#### Parameters

| Parameter         | Description             |
|-------------------|-------------------------|
| <code>hObj</code> | Handle of RADIO widget. |
| <code>v</code>    | Value to be set.        |

#### Additional information

The topmost RADIO button in a RADIO widget always has the 0 value, the next button down is always 1, the next is 2, etc.

## 6.2.23.5.2 Defines

### 6.2.23.5.2.1 RADIO bitmap indexes

#### Description

Bitmap indexes used by routines to change the bitmaps of a RADIO widget.

#### Definition

```
#define RADIO_BI_INACTIVE    0
#define RADIO_BI_ACTIVE     1
#define RADIO_BI_CHECK      2
```

#### Symbols

| Definition                        | Description                                       |
|-----------------------------------|---|
| <a href="#">RADIO_BI_INACTIVE</a> | Outer image used to show a disabled RADIO button. |
| <a href="#">RADIO_BI_ACTIVE</a>   | Outer image used to show a enabled RADIO button.  |
| <a href="#">RADIO_BI_CHECK</a>    | Inner image used to mark the selected item.       |

### 6.2.23.6 Examples

The `Sample` folder contains the following example which shows how the widget can be used:

- `DIALOG_Radio.c`

Note that several other examples also make use of this widget and may also be helpful to get familiar with the widget.

#### Screenshot of `DIALOG_Radio.c`

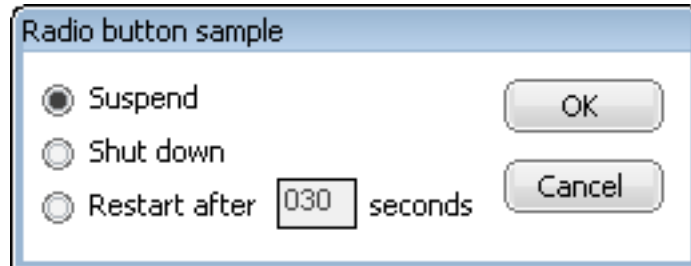



## 6.2.24 ROTARY: Rotary widget

The ROTARY widget is a reworked version of the KNOB widget, therefore they share some similarities. Just as the KNOB, the ROTARY is a widget the user can rotate. From the rotation degree values are determined which can be used within the application.

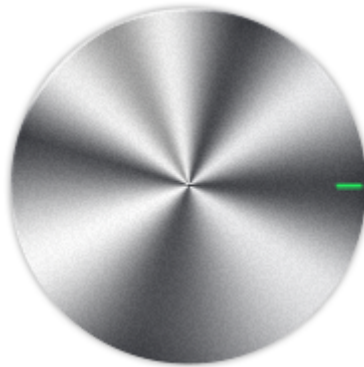

A ROTARY widget consists of a background bitmap and a marker bitmap. Optionally, the marker bitmap can be rotated while the widget is rotating, but the background bitmap does not rotate.

### Note

All ROTARY-related routines are located in the file(s) `ROTARY.c` and `ROTARY.h`. All identifiers are prefixed with `ROTARY`.

### Ticks and tick size

Just as with the KNOB widget, a ROTARY is divided into ticks. A tick describes the smallest range of movement of a ROTARY widget. The smallest size of one tick (tick size = 1) equates to 1/10 of a degree. Therefore it takes 3600 ticks to fulfill one round. The size of one tick can be set with the function `ROTARY_SetTickSize()`.

| Examples |                     |
|----------|---------------------|
| Ticksize | Ticks for one round |
| 60       | 60                  |
| 36       | 100                 |
| 300      | 12                  |

### Memory requirements

While the KNOB widget uses a memory device for the entire background, the ROTARY widget doesn't. This is not necessary since the background of the ROTARY is not rotated. Only the marker of a ROTARY can be rotated. If the user chooses to rotate the marker, the memory usage will be a bit higher, depending on the size of the marker bitmap.

### 6.2.24.1 Configuration options

| Type | Macro                                | Default | Description                               |
|------|--------------------------------------|---------|---|
| N    | <code>ROTARY_PERIOD_DEFAULT</code>   | 1500    | Period in ms it takes the ROTARY to stop. |
| N    | <code>ROTARY_TICKSIZE_DEFAULT</code> | 1       | Size of one tick in 1/10 of degree.       |

### 6.2.24.2 Predefined IDs

The following symbols define IDs which may be used to make ROTARY widgets distinguishable from creation.

```
#define GUI_ID_ROTARY0    0x310
#define GUI_ID_ROTARY1    0x311
#define GUI_ID_ROTARY2    0x312
#define GUI_ID_ROTARY3    0x313
#define GUI_ID_ROTARY4    0x314
#define GUI_ID_ROTARY5    0x315
#define GUI_ID_ROTARY6    0x316
#define GUI_ID_ROTARY7    0x317
#define GUI_ID_ROTARY8    0x318
#define GUI_ID_ROTARY9    0x319
```

### 6.2.24.3 Notification codes

The following events are sent from a ROTARY widget to its parent window as part of a WM\_NOTIFY\_PARENT message:

| Message                        | Description  |
|--------------------------------|--|
| WM_NOTIFICATION_CLICKED        | ROTARY has been clicked.   |
| WM_NOTIFICATION_RELEASED       | ROTARY has been released.  |
| WM_NOTIFICATION_MOTION_STOPPED | Movement of the ROTARY has stopped.  |
| WM_NOTIFICATION_MOVED_OUT      | ROTARY has been clicked and pointer has been moved out of the ROTARY area without releasing. |
| WM_NOTIFICATION_VALUE_CHANGED  | The value of the ROTARY widget has been changed.   |

### 6.2.24.4 Keyboard reaction

The widget reacts to the following keys if it has the input focus. Depending on the arrow key, per press the size of one tick is either added or subtracted to the ROTARY's angle.

| Key           | Reaction                |
|---------------|-------------------------|
| GUI_KEY_RIGHT | The ROTARY rotates CW.  |
| GUI_KEY_LEFT  | The ROTARY rotates CCW. |
| GUI_KEY_DOWN  | The ROTARY rotates CW.  |
| GUI_KEY_UP    | The ROTARY rotates CCW. |

## 6.2.24.5 ROTARY API

| Routine                              | Description   |
|--------------------------------------|---|
| <code>ROTARY_AddAngle()</code>       | Adds an angle to a ROTARY widget.                               |
| <code>ROTARY_AddValue()</code>       | Adds a given value to a ROTARY widget.                          |
| <code>ROTARY_CreateEx()</code>       | Creates a ROTARY widget.  |
| <code>ROTARY_CreateIndirect()</code> | Creates a ROTARY widget from a resource table entry.            |
| <code>ROTARY_CreateUser()</code>     | Creates a ROTARY widget using extra bytes as user data.         |
| <code>ROTARY_GetAngle()</code>       | Returns the current angle of a ROTARY widget.                   |
| <code>ROTARY_GetImageSize()</code>   | Returns the size of the background image.                       |
| <code>ROTARY_GetMarkerSize()</code>  | Returns the size of the marker bitmap.                          |
| <code>ROTARY_GetUserData()</code>    | Retrieves the data set with <code>ROTARY_SetUserData()</code> . |
| <code>ROTARY_GetValue()</code>       | Returns the value of a ROTARY widget.                           |
| <code>ROTARY_SetAngle()</code>       | Sets the current angle of a ROTARY widget.                      |
| <code>ROTARY_SetBitmap()</code>      | Sets the background bitmap of a ROTARY widget.                  |
| <code>ROTARY_SetDoRotate()</code>    | Sets the marker image of a ROTARY widget to be rotated.         |
| <code>ROTARY_SetMarker()</code>      | Sets the marker bitmap of a ROTARY widget.                      |
| <code>ROTARY_SetOffset()</code>      | Sets the offset of a ROTARY widget.                             |
| <code>ROTARY_SetPeriod()</code>      | Sets the period of a ROTARY widget.                             |
| <code>ROTARY_SetRadius()</code>      | Sets the radius of a ROTARY widget.                             |
| <code>ROTARY_SetRange()</code>       | Sets the usable range of a ROTARY widget.                       |
| <code>ROTARY_SetSnap()</code>        | Sets a snap position for a ROTARY widget.                       |
| <code>ROTARY_SetTickSize()</code>    | Sets the tick size of a ROTARY widget.                          |
| <code>ROTARY_SetUserData()</code>    | Sets the extra data of a ROTARY widget.                         |
| <code>ROTARY_SetValue()</code>       | Sets the value of a ROTARY widget.                              |
| <code>ROTARY_SetValueRange()</code>  | Sets the usable range of values of a ROTARY widget.             |

### 6.2.24.5.1 ROTARY\_AddAngle()

#### Description

Adds an angle to a ROTARY widget.

#### Prototype

```
void ROTARY_AddAngle(ROTARY_Handle hObj,  
                    I32           Delta);
```

#### Parameters

| Parameter             | Description                |
|-----------------------|----------------------------|
| <a href="#">hObj</a>  | Handle of a ROTARY widget. |
| <a href="#">Delta</a> | Angle to be added.         |

### 6.2.24.5.2 ROTARY\_AddValue()

#### Description

Adds a given value to a ROTARY widget.

#### Prototype

```
void ROTARY_AddValue(ROTARY_Handle hObj,  
                    I32           Delta);
```

#### Parameters

| Parameter             | Description                |
|-----------------------|----------------------------|
| <a href="#">hObj</a>  | Handle of a ROTARY widget. |
| <a href="#">Delta</a> | Value to be added.         |

### 6.2.24.5.3 ROTARY\_CreateEx()

#### Description

Creates a ROTARY widget.

#### Prototype

```
ROTARY_Handle ROTARY_CreateEx(int    x0,
                              int    y0,
                              int    xSize,
                              int    ySize,
                              WM_HWIN hParent,
                              int    WinFlags,
                              int    Id);
```

#### Parameters

| Parameter             | Description  |
|-----------------------|--|
| <code>x0</code>       | Leftmost pixel of the ROTARY widget (in parent coordinates).   |
| <code>y0</code>       | Topmost pixel of the ROTARY widget (in parent coordinates).  |
| <code>xSize</code>    | Horizontal size of the ROTARY widget (in pixels).  |
| <code>ySize</code>    | Vertical size of the ROTARY widget (in pixels).  |
| <code>hParent</code>  | Parent window of the ROTARY widget.  |
| <code>WinFlags</code> | Window create flags. Typically <code>WM_CF_SHOW</code> in order to make the widget visible immediately (refer to <i>Window create flags</i> on page 977 for a list of available parameter values). |
| <code>Id</code>       | ID of the ROTARY widget.   |

#### Return value

Handle of ROTARY widget.

#### 6.2.24.5.4 ROTARY\_CreateIndirect()

##### Description

Prototype explained at the beginning of the chapter as `<WIDGET>_CreateIndirect()` on page 992. The elements `Flags` and `Para` of the resource passed as parameter are not used.

### 6.2.24.5.5 ROTARY\_CreateUser()

#### Description

Prototype explained at the beginning of the chapter as `<WIDGET>_CreateUser()` on page 993. For a detailed description of the parameters the function `KNOB_CreateEx()` can be referred to.



### 6.2.24.5.6 ROTARY\_GetAngle()

#### Description

Returns the current angle of a ROTARY widget.

#### Prototype

```
I32 ROTARY_GetAngle(ROTARY_Handle hObj);
```

#### Parameters

| Parameter            | Description                |
|----------------------|----------------------------|
| <a href="#">hObj</a> | Handle of a ROTARY widget. |

#### Return value

Angle of the ROTARY widget.

### 6.2.24.5.7 ROTARY\_GetImageSize()

#### Description

Returns the size of the background image.

#### Prototype

```
int ROTARY_GetImageSize(ROTARY_Handle  hObj,  
                        int             * pxSize,  
                        int             * pySize);
```

#### Parameters

| Parameter           | Description                                |
|---------------------|--|
| <code>hObj</code>   | Handle of a ROTARY widget.                 |
| <code>pxSize</code> | Pointer to an integer to store the x-size. |
| <code>pySize</code> | Pointer to an integer to store the y-size. |

#### Return value

- 0        If the routine succeeds.
- 1        If the routine fails.

### 6.2.24.5.8 ROTARY\_GetMarkerSize()

#### Description

Returns the size of the marker bitmap.

#### Prototype

```
int ROTARY_GetMarkerSize(ROTARY_Handle  hObj,  
                        int             * pxSize,  
                        int             * pySize);
```

#### Parameters

| Parameter              | Description                                |
|------------------------|--|
| <a href="#">hObj</a>   | Handle of a ROTARY widget.                 |
| <a href="#">pxSize</a> | Pointer to an integer to store the x-size. |
| <a href="#">pySize</a> | Pointer to an integer to store the y-size. |

#### Return value

- 0        If the routine succeeds.
- 1        If the routine fails.

### 6.2.24.5.9 ROTARY\_GetUserData()

#### Description

Prototype explained at the beginning of the chapter as `<WIDGET>_GetUserData()` on page 994.

### 6.2.24.5.10 ROTARY\_GetValue()

#### Description

Returns the value of a ROTARY widget. This value depends on the set range of the widget.

#### Prototype

```
I32 ROTARY_GetValue(ROTARY_Handle hObj);
```

#### Parameters

| Parameter            | Description                |
|----------------------|----------------------------|
| <a href="#">hObj</a> | Handle of a ROTARY widget. |

#### Return value

Value of the ROTARY widget.

### 6.2.24.5.11 ROTARY\_SetAngle()

#### Description

Sets the current angle of a ROTARY widget. The angle has to be within the valid range.

#### Prototype

```
void ROTARY_SetAngle(ROTARY_Handle hObj,  
                    I32 Pos);
```

#### Parameters

| Parameter            | Description                |
|----------------------|----------------------------|
| <a href="#">hObj</a> | Handle of a ROTARY widget. |
| <a href="#">Pos</a>  | Angle to be added.         |

### 6.2.24.5.12 ROTARY\_SetBitmap()

#### Description

Sets the background bitmap of a ROTARY widget. This bitmap won't be rotated.

#### Prototype

```
void ROTARY_SetBitmap(    ROTARY_Handle  hObj,  
                        const GUI_BITMAP * pBitmap);
```

#### Parameters

| Parameter            | Description                |
|----------------------|----------------------------|
| <code>hObj</code>    | Handle of a ROTARY widget. |
| <code>pBitmap</code> | Pointer to a bitmap.       |

### 6.2.24.5.13 ROTARY\_SetDoRotate()

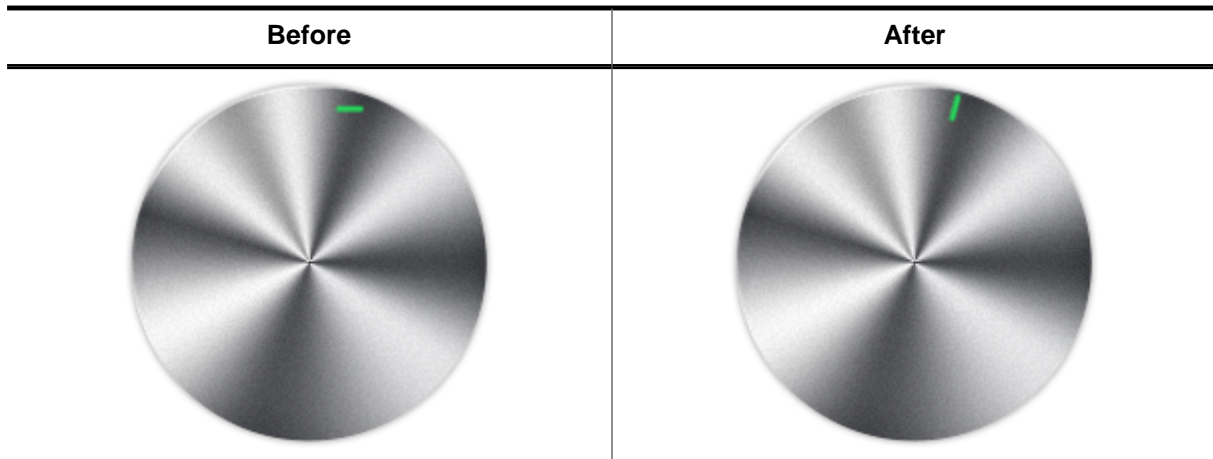

#### Description

Sets the marker image of a ROTARY widget to be rotated.

#### Prototype

```
void ROTARY_SetDoRotate(ROTARY_Handle hObj,
                       U8             DoRotate);
```

#### Parameters

| Parameter | Description                             |
|-----------|---|
| hObj      | Handle of a ROTARY widget.              |
| DoRotate  | If the marker bitmap should be rotated. |



### 6.2.24.5.14 ROTARY\_SetMarker()

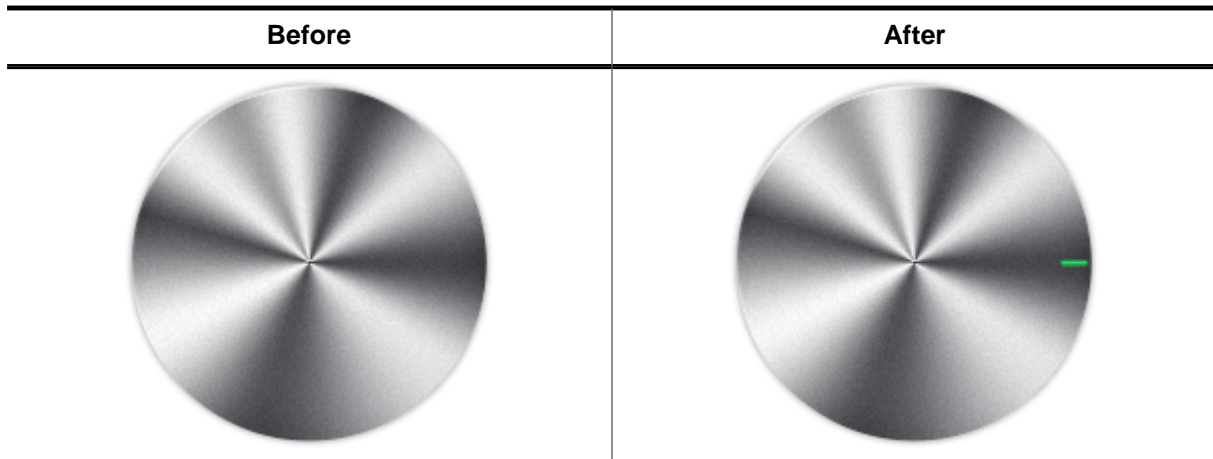

#### Description

Sets the marker bitmap of a ROTARY widget.

#### Prototype

```
void ROTARY_SetMarker(    ROTARY_Handle  hObj,
                        const GUI_BITMAP * pBitmap,
                        int          Radius,
                        I32          Offset,
                        U8           DoRotate);
```

#### Parameters

| Parameter                | Description  |
|--------------------------|--|
| <a href="#">hObj</a>     | Handle of a ROTARY widget.                             |
| <a href="#">pBitmap</a>  | Pointer to a bitmap to be set as marker.               |
| <a href="#">Radius</a>   | Mid-point difference between widget and marker bitmap. |
| <a href="#">Offset</a>   | Angle offset for drawing marker.                       |
| <a href="#">DoRotate</a> | If the marker bitmap should be rotated.                |

### 6.2.24.5.15 ROTARY\_SetOffset()

#### Description

Sets the offset of a ROTARY widget.

#### Prototype

```
void ROTARY_SetOffset(ROTARY_Handle hObj,  
                     int Offset);
```

#### Parameters

| Parameter           | Description                    |
|---------------------|--------------------------------|
| <code>hObj</code>   | Handle of a ROTARY widget.     |
| <code>Offset</code> | <code>Offset</code> to be set. |

### 6.2.24.5.16 ROTARY\_SetPeriod()

#### Description

Sets the period of a ROTARY widget. This period determines when the rotation of the widget stops.

#### Prototype

```
void ROTARY_SetPeriod(ROTARY_Handle hObj,  
                     I32           Period);
```

#### Parameters

| Parameter           | Description                    |
|---------------------|--------------------------------|
| <code>hObj</code>   | Handle of a ROTARY widget.     |
| <code>Period</code> | <code>Period</code> to be set. |

#### Additional information

The default period is 1500ms. The maximum value for the period is 46340ms.

### 6.2.24.5.17 ROTARY\_SetRadius()

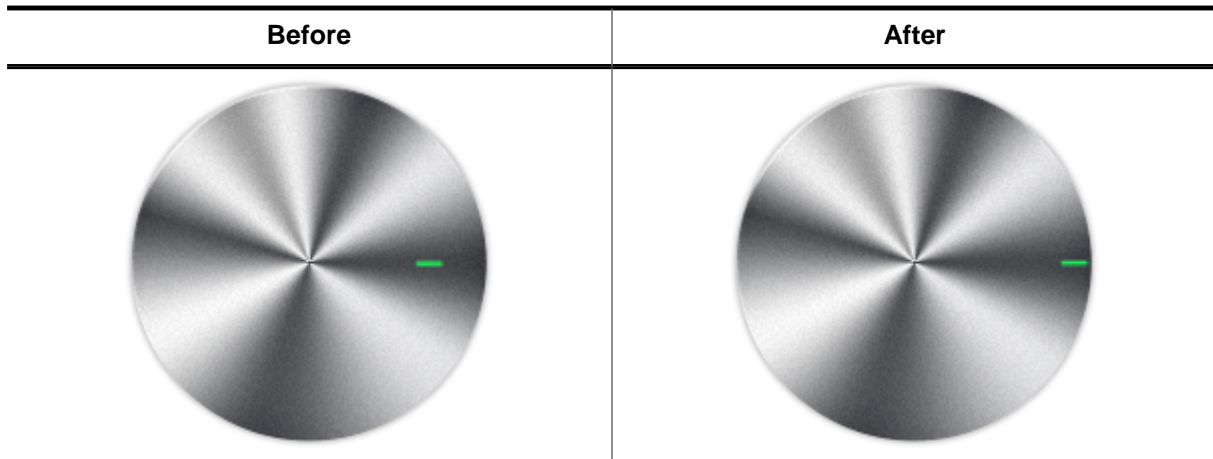

#### Description

Sets the radius of a ROTARY widget.

#### Prototype

```
void ROTARY_SetRadius(ROTARY_Handle hObj,  
                     int           Radius);
```

#### Parameters

| Parameter              | Description                                  |
|------------------------|--|
| <a href="#">hObj</a>   | Handle of a ROTARY widget.                   |
| <a href="#">Radius</a> | <a href="#">Radius</a> of the ROTARY widget. |

### 6.2.24.5.18 ROTARY\_SetRange()

#### Description

Sets the usable range of a ROTARY widget.

#### Prototype

```
void ROTARY_SetRange(ROTARY_Handle hObj,  
                    U32           AngPositive,  
                    U32           AngNegative);
```

#### Parameters

| Parameter                   | Description                |
|-----------------------------|----------------------------|
| <a href="#">hObj</a>        | Handle of a ROTARY widget. |
| <a href="#">AngPositive</a> | Starting angle.            |
| <a href="#">AngNegative</a> | Ending angle.              |

### 6.2.24.5.19 ROTARY\_SetSnap()

#### Description

Sets a snap position for a ROTARY widget. A snap position is a position measured in ticks where the widget automatically stops rotating.

#### Prototype

```
void ROTARY_SetSnap(ROTARY_Handle hObj,  
                   I32           Snap);
```

#### Parameters

| Parameter            | Description                              |
|----------------------|--|
| <a href="#">hObj</a> | Handle of a ROTARY widget.               |
| <a href="#">Snap</a> | <a href="#">Snap</a> position to be set. |

#### Additional information

The default value is 0. If set to 0, there is no snap position.

### 6.2.24.5.20 ROTARY\_SetTickSize()

#### Description

Sets the tick size of a ROTARY widget. The tick size is measured in 10th of degrees.

#### Prototype

```
void ROTARY_SetTickSize(ROTARY_Handle hObj,  
                        I32           TickSize);
```

#### Parameters

| Parameter             | Description                     |
|-----------------------|---------------------------------|
| <code>hObj</code>     | Handle of a ROTARY widget.      |
| <code>TickSize</code> | Tick size of the ROTARY widget. |

#### Additional information

This routine has to be called before any other ROTARY related routines, except any ROTARY\_Create...() routines of course.

### 6.2.24.5.21 ROTARY\_SetUserData()

#### Description

Prototype explained at the beginning of the chapter as `<WIDGET>_SetUserData()` on page 995.



### 6.2.24.5.22 ROTARY\_SetValue()

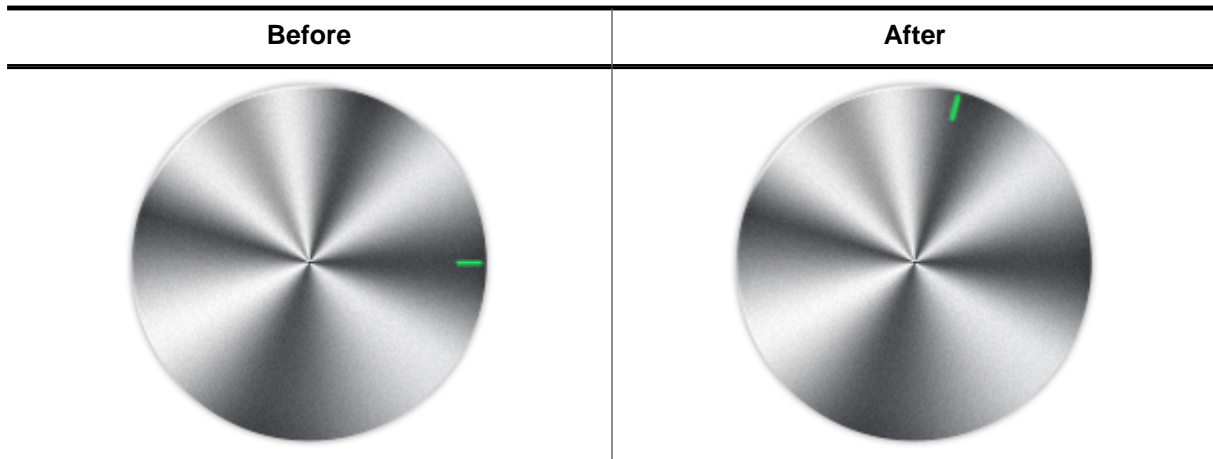

#### Description

Sets the value of a ROTARY widget.

#### Prototype

```
void ROTARY_SetValue(ROTARY_Handle hObj,
                    I32 Value);
```

#### Parameters

| Parameter | Description                |
|-----------|----------------------------|
| hObj      | Handle of a ROTARY widget. |
| Value     | Value to be added.         |

#### Additional information

The angle depends on the range set with `ROTARY_SetRange()` and `ROTARY_SetValueRange()`.

### 6.2.24.5.23 ROTARY\_SetValueRange()

#### Description

Sets the usable range of values of a ROTARY widget.

#### Prototype

```
int ROTARY_SetValueRange(ROTARY_Handle hObj,  
                        I32           Min,  
                        I32           Max);
```

#### Parameters

| Parameter            | Description                |
|----------------------|----------------------------|
| <a href="#">hObj</a> | Handle of a ROTARY widget. |
| <a href="#">Min</a>  | Minimum value.             |
| <a href="#">Max</a>  | Maximum value.             |

#### Return value

- 0 If the routine succeeds.
- 1 If the routine fails.

## 6.2.25 SCROLLER: Scroll widget

The SCROLLER widget is a newer version of the SCROLLBAR with more modern UI.

SCROLLERS are used to indicate the scrolling position in a window with scrollable content. This especially makes sense if motion scrolling is enabled. Also, they can optionally be used to scroll through the window the SCROLLER is attached to.

A SCROLLER is typically attached to an existing window or widget, as shown below:

| Name  | First Name | Ext.  | Title                | Email                           |
|-------|------------|-------|----------------------|---------------------------------|
| erson | Leslie     | x4065 | Sales Rep            | lthompson@classicmodelcars.com  |
| li    | Julie      | x2173 | Sales Rep            | jfirrelli@classicmodelcars.com  |
| erson | Steve      | x4334 | Sales Rep            | spatterson@classicmodelcars.com |
| g     | Foon Yue   | x2248 | Sales Rep            | ftseng@classicmodelcars.com     |
| hy    | Diane      | x5800 | President            | dmurphy@classicmodelcars.com    |
| erson | Mary       | x4611 | VP Sales             | mpatterson@classicmodelcars.com |
| li    | Jeff       | x9273 | VP Marketing         | jfirrelli@classicmodelcars.com  |
| erson | William    | x4871 | Sales Manager (APAC) | wpatterson@classicmodelcars.com |
| ur    | Gerard     | x5408 | Sale Manager (EMEA)  | gbondur@classicmodelcars.com    |
|       | Anthony    | x5428 | Sales Manager (NA)   | abow@classicmodelcars.com       |
| ings  | Leslie     | x3291 | Sales Rep            | ljennings@classicmodelcars.com  |
| erson | Leslie     | x4065 | Sales Rep            | lthompson@classicmodelcars.com  |
| li    | Julie      | x2173 | Sales Rep            | jfirrelli@classicmodelcars.com  |
| erson | Steve      | x4334 | Sales Rep            | spatterson@classicmodelcars.com |
| g     | Foon Yue   | x2248 | Sales Rep            | ftseng@classicmodelcars.com     |
| hy    | Diane      | x5800 | President            | dmurphy@classicmodelcars.com    |
| erson | Mary       | x4611 | VP Sales             | mpatterson@classicmodelcars.com |
| li    | Jeff       | x9273 | VP Marketing         | jfirrelli@classicmodelcars.com  |
| erson | William    | x4871 | Sales Manager (APAC) | wpatterson@classicmodelcars.com |
| ur    | Gerard     | x5408 | Sale Manager (EMEA)  | gbondur@classicmodelcars.com    |



SCROLLERS may be created horizontally or vertically.

SCROLLERS can be attached to certain emWin widgets that have scrollable content and attaching to custom widgets is also possible, as described further below.

### Note

All SCROLLER-related routines are located in the file(s) `SCROLLER*.c`, `SCROLLER.h`. All identifiers are prefixed `SCROLLER`.

### 6.2.25.1 Structure of the SCROLLER widget

The following diagram shows the detailed structure and look of the SCROLLER widget:

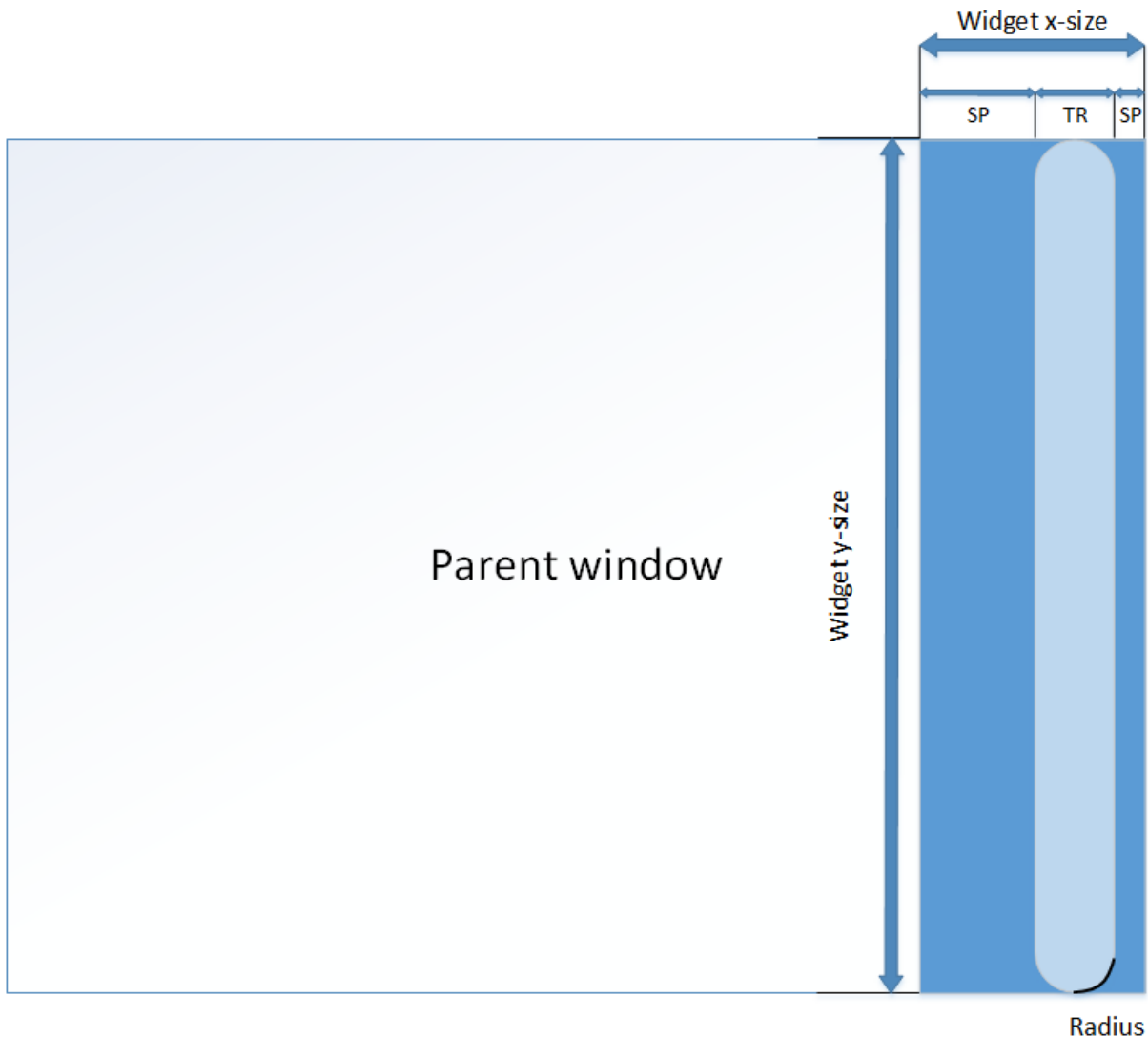

| Details       | Description  |
|---------------|--|
| SP            | Spacing, can be set with <code>SCROLLER_SetSpacing()</code> .  |
| TR            | Width of thumb rectangle, can be set with <code>SCROLLER_SetSize()</code> .  |
| Widget x-size | The SCROLLER widget's x-size is the result of <code>SP + TR</code> .   |
| Widget y-size | The SCROLLER widget's y-size is the y-size of the parent window's content rectangle. The content rectangle can be retrieved using <code>WM_GetContentRectEx()</code> . |
| Radius        | The radius of the thumb rectangle, can be set with <code>SCROLLER_SetRadius()</code> .   |
| Parent window | Parent window the SCROLLER is attached to.   |

#### Horizontal SCROLLERS

The above diagram is analog for horizontal SCROLLERS, except that

- TR is the height of the thumb rectangle instead.
- How the widget's x-size and y-size are defined is inverted.

## 6.2.25.2 Configuration options

| Type | Macro                                | Default                              | Description   |
|------|--------------------------------------|--------------------------------------|---|
| N    | SCROLLER_COLOR_ACTIVE_DEFAULT        | GUI_MAKE_COLOR(0x50606060)           | Color of the SCROLLER in its active state.  |
| N    | SCROLLER_COLOR_INACTIVE_DEFAULT      | GUI_MAKE_COLOR(0x50AAAAAA)           | Color of the SCROLLER in its inactive state.  |
| N    | SCROLLER_BKCOLOR_ACTIVE_DEFAULT      | GUI_TRANSPARENT                      | Background color of the SCROLLER in its active state.   |
| N    | SCROLLER_BKCOLOR_INACTIVE_DEFAULT    | GUI_TRANSPARENT                      | Background color of the SCROLLER in its inactive state.   |
| N    | SCROLLER_RADIUS_DEFAULT              | 3                                    | Radius of the rounded rectangle.  |
| N    | SCROLLER_SIZE_DEFAULT                | 6                                    | <b>Horizontal SCROLLER:</b> Height of the thumb rectangle.<br><b>Vertical SCROLLER:</b> Width of the thumb rectangle.                 |
| N    | SCROLLER_SPACING_DEFAULT             | 24                                   | Spacing to be added to be SCROLLER widget area.   |
| N    | SCROLLER_FADE_IN_PERIOD_DEFAULT      | 200                                  | Period for fading in, from inactive to active state.  |
| N    | SCROLLER_FADE_OUT_PERIOD_DEFAULT     | 200                                  | Period for fading out, from active to inactive state.   |
| N    | SCROLLER_INACTIVE_PERIOD_DEFAULT     | 200                                  | Timer period for when the SCROLLER should become inactive after it stopped moving or has been released.                               |
| N    | SCROLLER_ANIM_PERIOD_DEFAULT         | 150                                  | Duration of scrolling animation.  |
| N    | SCROLLER_ANIM_EASE_FADE_DEFAULT      | ANIM_ACCELDECEL                      | Animation ease to be used for the fading animation.   |
| N    | SCROLLER_ANIM_EASE_SCROLL_DEFAULT    | ANIM_ACCELDECEL                      | Animation ease to be used for the scrolling animation.  |
| N    | SCROLLER_ALIGNMENT_WIDGETPOS_DEFAULT | (GUI_ALIGN_RIGHT   GUI_ALIGN_BOTTOM) | Alignment of the SCROLLER within the parent widget.   |
| N    | SCROLLER_ALIGNMENT_THUMB_DEFAULT     | (GUI_ALIGN_RIGHT   GUI_ALIGN_BOTTOM) | Alignment of the thumb rectangle within the SCROLLER window.  |
| N    | SCROLLER_ALIGNMENT_OFFSET_DEFAULT    | -3                                   | Offset to SCROLLER_ALIGNMENT_THUMB_DEFAULT.   |
| N    | SCROLLER_THUMB_SIZE_MIN_DEFAULT      | 10                                   | <b>Horizontal SCROLLER:</b> Minimum width of the thumb rectangle.<br><b>Vertical SCROLLER:</b> Minimum height of the thumb rectangle. |

## 6.2.25.3 Predefined IDs

The following symbols define IDs which may be used to make SCROLLER widgets distinguishable from creation.

```
#define GUI_ID_SCROLLER0    0x380
#define GUI_ID_SCROLLER1    0x381
#define GUI_ID_SCROLLER2    0x382
#define GUI_ID_SCROLLER3    0x383
#define GUI_ID_SCROLLER4    0x384
```

```
#define GUI_ID_SCROLLER5    0x385
#define GUI_ID_SCROLLER6    0x386
#define GUI_ID_SCROLLER7    0x387
#define GUI_ID_SCROLLER8    0x388
#define GUI_ID_SCROLLER9    0x389
```

When a SCROLLER is attached to another window, the following IDs are used, based on whether the SCROLLER is vertical or horizontal.

```
#define GUI_ID_VSCROLLER    0xFFE
#define GUI_ID_HSCROLLER    0xFFF
```

### 6.2.25.4 Notification codes

The following events are sent from a SCROLLER widget to its parent window as part of a WM\_NOTIFY\_PARENT message:

| Message                        | Description   |
|--------------------------------|---|
| WM_NOTIFICATION_CLICKED        | SCROLLER has been clicked.  |
| WM_NOTIFICATION_RELEASED       | SCROLLER has been released.   |
| WM_NOTIFICATION_SCROLLER_ADDED | SCROLLER has just been added (attached) to an existing window. The window is notified so that it can initialize the SCROLLER. |
| WM_NOTIFICATION_VALUE_CHANGED  | Value of SCROLLER has been changed.   |

### 6.2.25.5 Widget behavior

#### Widget states

The SCROLLER is in active state during scrolling and in inactive state when it is not being moved. Both states have their own color.

Most interactions that alter the scrolling position of the SCROLLER's parent widget set the SCROLLERs state to active to indicate the scrolling movement. This can be one of the following movements:

- Motion swiping
- Scrolling by touching the SCROLLER widget itself
- Scrolling by key movements

When the SCROLLER has entered the active state by touch or motion scrolling, it will stay in the active state as long as the touch is not released.

#### Inactive timer

When the touch has been released or movement has stopped, after a given delay the SCROLLER will fade back into the inactive state. This delay can be set with SCROLLER\_SetPeriod() and the period index SCROLLER\_PI\_INACTIVE.

#### Fading

The widget can fade between the active and inactive state. This can be enabled or disabled with SCROLLER\_EnableFade(), or by passing the flag SCROLLER\_CF\_FADING when creating the widget. The fading period can be set using SCROLLER\_SetPeriod() with the period index SCROLLER\_PI\_FADE.

#### Touch input

If touch input is not enabled, the SCROLLER simply acts as an indicator widget that displays the current scroll state. Any touch input gets sent to the below parent widget.

Alternatively, touch can be activated which allows for quick scrolling through the parent's content. Touch can be enabled or disabled by calling SCROLLER\_EnableTouch() or by passing the flag SCROLLER\_CF\_TOUCH when creating the SCROLLER.

When touch is enabled and the user touches outside the thumb rectangle, the thumb and scroll state will be animated to the given position in a given amount of time. The time for this scrolling animation can be set with `SCROLLER_SetPeriod()` and the period index `SCROLLER_PI_ANIM_SCROLL`.

The thumb rectangle can also be clicked and dragged to a new position.

### Automatic resizing

If a vertical and horizontal `SCROLLER` are added to a widget and both have touch input active, one `SCROLLER` will be resized so that there are no conflicts between the two touch areas. This is explained in more detail under `SCROLLER_EnableAutoResize()`.

## 6.2.25.6 Attaching SCROLLERS to widgets

The `SCROLLER` can be attached to all widgets, that provide native motion support. This is typically indicated when the given widget has a routine `<WIDGET>_EnableMotion()`. `SCROLLERS` can be attached to the following widgets:

- `DROPDOWN`
- `LISTBOX`
- `LISTVIEW`
- `MULTIEDIT`
- `SWIPELIST`

### Attaching a SCROLLER

A `SCROLLER` can be attached to any of the above mentioned widgets using `SCROLLER_CreateAttached()`.

```
hListview = LISTVIEW_CreateEx(0, 0, LCD_GetXSize(), LCD_GetYSize(), WM_HBKWIN,
                             WM_CF_SHOW, 0, GUI_ID_LISTVIEW0);
LISTVIEW_EnableMotion(hListview, LISTVIEW_CF_MOTION_V);
hScroller = SCROLLER_CreateAttached(hListview, SCROLLER_CF_VERTICAL |
                                     SCROLLER_CF_FADING |
                                     SCROLLER_CF_TOUCH);
```

### Overwritten callbacks

When a custom callback is used for one of the above mentioned widgets, it should be made sure that the custom callback calls the widget's default callback for all messages that are not handled by the custom callback, as well as all unhandled `WM_NOTIFY_PARENT` notifications.

## 6.2.25.7 Attaching SCROLLERS to custom widgets

Before a SCROLLER widget can be attached to a custom widget or window, there are a few steps necessary. These steps are listed below.

### Widget requirements

The widget should store the scrolling information (for horizontal and/or vertical scrolling, as desired) in memory. The widget's content should obviously move based on this scrolling value.

For this, the structure `WM_SCROLL_STATE` can be used. All values should be in pixels. The structure contains the three required values to save the scrolling position:

- **v:** Current scrolling position in pixels.
- **NumItems:** Total number of pixels that can be scrolled through. E.g. for a scrollable list, this would be the height of the entire scrolling area in pixels, from top to bottom. If for example a list had ten items each with a height of 20px, then `NumItems` would be 200.
- **PageSize:** The size in pixels of one page. One page is the area that is visible at once, without scrolling.

### Widget interfacing

Now, a structure of the type `SCROLLER_INTERFACE_API` has to be filled. This structure contains four functions required for the interfacing between the SCROLLER and the custom parent widget:

- **pfUpdateScrollPos():** The scroll state was changed by the parent and the new state is set to the SCROLLER.
- **pfValueChanged():** The SCROLLER changed the scroll state and the new state is set to the parent.
- **pfScrollerAdded():** Called when the SCROLLER is added to the parent widget, can be used to set SCROLLER or window properties.
- **pfGetContentRect():** Returns the content rectangle which is the scrollable area within the parent widget. The SCROLLER's size and position are derived from the content rectangle.

### pfUpdateScrollPos()

The function `pfUpdateScrollPos` should set the current scroll state that is saved in the parent widget to the SCROLLER widget. This can be done like this:

```

/*****
 *
 *     _UpdateScrollPos
 */
static void _UpdateScrollPos(WM_HWIN hParent, SCROLLER_Handle hScroller) {
    WM_SCROLL_STATE State;

    //
    // Retrieve scroll state from parent widget...
    //
    PARENT_GetScrollState(hParent, &State);
    //
    // Set the scroll state to SCROLLER
    //
    SCROLLER_SetScrollState(hScroller, &State);
}

```



## pfValueChanged()

The function `pfValueChanged` is called when the SCROLLER sends a `WM_NOTIFICATION_VALUE_CHANGED` notification to its parent widget. The parameter `pNewState` contains the new scroll state. The function should set this scroll state to the parent widget. Optionally, the scroll state can be manipulated, before it is set.

```

/*****
 *
 *      _OnValueChanged
 */
static void _OnValueChanged(WM_HWIN hParent, SCROLLER_Handle hScroller, WM_SCROLL_STATE * pNewState) {
    GUI_USE_PARA(hScroller);
    //
    // Set new scroll state to parent and redraw parent.
    //
    PARENT_SetScrollState(pNewState);
    WM_InvalidateWindow(hParent);
}

```

## pfScrollerAdded()

The function `pfScrollerAdded()` gets called right after the SCROLLER has been created and attached to the parent widget. In this function, the parent window should check if the size of the content actually justifies the use of SCROLLERS. If e.g. a list is too short to scroll through, the SCROLLER can be hidden at this point. Below is an example implementation.

```

/*****
 *
 *      _OnScrollerAdded
 */
static void _OnScrollerAdded(WM_HWIN hParent, SCROLLER_Handle hScroller) {
    WM_HWIN hScroller;
    U8      IsRequired;
    int     ListSize;
    int     ySize;

    ySize      = WM_GetYSize(hParent);
    ListSize   = PARENT_GetListSize(hParent);
    IsRequired = (ListSize > ySize) ? 1 : 0;
    if (IsRequired) {
        WM_ShowWindow(hScroller);
    } else {
        WM_HideWindow(hScroller);
    }
}

```

## pfGetContentRect()

The function `pfGetContentRect()` gets called when the parent window receives a `WM_GET_CONTENT_RECT` message. In this function, the parent window should return its content rectangle in client coordinates. The attached SCROLLER's position and size will be derived from the content rectangle.

```

/*****
 *
 *      _GetContentRect
 */
static void _GetContentRect(WM_HWIN hParent, GUI_RECT * pRect) {
    //
    // Reduce client rectangle by 20px on all vertices.
    //
    WM_GetClientRectEx(hParent, pRect);
    GUI_AddRect(pRect, pRect, -20);
}

```

If the content rectangle should be the same as the window's client rectangle, the entry in `SCROLLER_INTERFACE_API` can be left as `NULL`, so that the `WM_GET_CONTENT_RECT` message will be handled by `WM_DefaultProc()`.

### Add the message handler to the parent widget's callback

Now, the message handler `SCROLLER_ParentMsgHandler()` has to be added to the parent window's callback. It has to be made sure of that the following messages are passed to this handler **after** they have been processed by the parent window's callback, but **before** they are being passed to `WM_DefaultProc()`.

- `WM_MOTION` message
- `WM_NOTIFY_PARENT` message with the notifications `WM_NOTIFICATION_VALUE_CHANGED` and `WM_NOTIFICATION_SCROLLER_ADDED`.
- `WM_GET_CONTENT_RECT`

This can be ensured by a callback structure like shown below. If `SCROLLER_ParentMsgHandler()` does not handle the given message, the routine will return 1.

```

/*****
*
*      _cb
*/
static void _cb(WM_MESSAGE * pMsg) {
    switch (pMsg->MsgId) {
        //
        // Handle messages.
        // No 'return' statements in the messages WM_MOTION, WM_NOTIFY_PARENT
        // and WM_GET_CONTENT_RECT before SCROLLER_ParentMsgHandler() is called.
        //
        ...
    }
    //
    // Send messages also to the SCROLLER's message handler.
    //
    if (SCROLLER_ParentMsgHandler(pMsg)) {
        WM_DefaultProc(pMsg);
    }
}

```

### Overlap (optional)

If the parent window has motion support active and uses an overlapping value for swiping, two things have to be observed:

- The overlap value has to be set to the `Overlap` element of the `WM_MOTION_INFO` structure sent with the `WM_MOTION` message to the parent window.
- During swiping, the parent window has to set its pixelbased scroll state according to the overlap value. This means for example, if the overlapping area is entered at the top, e.g. by 10 px, then the scroll state should be set to -10. And vice versa, if the overlapping area at the bottom is entered, the overlapped distance is added to the scroll state.

### Manually set the active state (optional)

In some cases it can make sense if the parent widget also manually controls the `SCROLLER`'s active state. This can e.g. be desirable when the parent widget's scroll state can be changed by key inputs and the `SCROLLER` should change its visual state during this event.

To do so, the routine `SCROLLER_SetState()` can be used to manually set the desired state.

## Attach SCROLLER to custom widget

After all these steps have been executed properly, the given widget supports the use of SCROLLER widgets. Now, a SCROLLER widget can be attached to the window and the interface API can be set.

```
static const SCROLLER_INTERFACE_API _InterfaceAPI = {
    _UpdateScrollPos,    // pfUpdateScrollPos
    _OnScrollerAdded,   // pfScrollerAdded
    _OnValueChanged,   // pfValueChanged
    _GetContentRect,    // pfGetContentRect
};

WM_HWIN hParent;
WM_HWIN hScroller;

hScroller = SCROLLER_CreateAttached(hParent, SCROLLER_CF_VERTICAL);
SCROLLER_SetInterfaceAPI(hScroller, &_InterfaceAPI);
```

## 6.2.25.8 SCROLLER API

The table below lists the available emWin SCROLLER-related routines in alphabetical order. Detailed descriptions of the routines follow.

### Functions

| Routine  | Description   |
|--|---|
| <code>SCROLLER_AttachToWindow()</code>         | Attaches the given SCROLLER to a new parent window.   |
| <code>SCROLLER_CreateAttached()</code>         | Creates a scroll bar which is attached to an existing window.   |
| <code>SCROLLER_CreateIndirect()</code>         | Creates a SCROLLER widget from a resource table entry.  |
| <code>SCROLLER_CreateUser()</code>             | Creates a SCROLLER widget of a specified size at a specified location and allocates a given number of additional bytes. |
| <code>SCROLLER_EnableAutoResize()</code>       | Enables or disables automatic resizing of SCROLLER widgets.   |
| <code>SCROLLER_EnableFade()</code>             | Enables or disables fading mode for the SCROLLER widget.  |
| <code>SCROLLER_EnableTouch()</code>            | Enables or disables touch input for the SCROLLER widget.  |
| <code>SCROLLER_GetAlign()</code>               | Returns the given alignment set to the SCROLLER widget.   |
| <code>SCROLLER_GetAlignOffset()</code>         | Returns the alignment offset set to the SCROLLER rectangle.   |
| <code>SCROLLER_GetAnimEase()</code>            | Returns the animation ease for a given animation of the SCROLLER.   |
| <code>SCROLLER_GetBkColor()</code>             | Returns the background color of the SCROLLER widget.  |
| <code>SCROLLER_GetColor()</code>               | Returns the given color of the SCROLLER widget.   |
| <code>SCROLLER_GetDefaultAlign()</code>        | Returns the given default alignment for SCROLLER widgets.   |
| <code>SCROLLER_GetDefaultAlignOffset()</code>  | Returns the default alignment offset for newly created SCROLLER widgets.  |
| <code>SCROLLER_GetDefaultAnimEase()</code>     | Returns the default animation ease for a given animation for SCROLLER widgets.  |
| <code>SCROLLER_GetDefaultBkColor()</code>      | Returns the default background color of the SCROLLER widget.  |
| <code>SCROLLER_GetDefaultColor()</code>        | Returns the given default color for SCROLLER widgets.   |
| <code>SCROLLER_GetDefaultPeriod()</code>       | Returns the given default period for SCROLLER widgets.  |
| <code>SCROLLER_GetDefaultRadius()</code>       | Returns the default radius used for SCROLLER widgets.   |
| <code>SCROLLER_GetDefaultThumbSizeMin()</code> | Returns the default minimum thumb size used for SCROLLER widgets.   |
| <code>SCROLLER_GetDefaultSize()</code>         | Returns the default width/height used for the SCROLLER rectangle.   |
| <code>SCROLLER_GetDefaultSpacing()</code>      | Returns the default spacing used for newly created SCROLLER widgets.  |

| Routine                                       | Description  |
|---|--|
| <code>SCROLLER_GetPeriod()</code>             | Returns the given period of the SCROLLER widget.   |
| <code>SCROLLER_GetRadius()</code>             | Returns the radius of the SCROLLER widget.   |
| <code>SCROLLER_GetScrollState()</code>        | Retrieves the current scroll state of the SCROLLER.  |
| <code>SCROLLER_GetSize()</code>               | Returns the thickness of the SCROLLER thumb rectangle.   |
| <code>SCROLLER_GetSpacing()</code>            | Returns the spacing of the SCROLLER widget.  |
| <code>SCROLLER_GetThumbRect()</code>          | Returns the current thumb rectangle in coordinates relative to the SCROLLER.                                       |
| <code>SCROLLER_GetThumbSizeMin()</code>       | Returns the minimum thumb size of the SCROLLER widget.   |
| <code>SCROLLER_GetUserData()</code>           | Retrieves the extra data of a SCROLLER widget.   |
| <code>SCROLLER_OwnerDraw()</code>             | Default function for managing drawing operations of the SCROLLER widget.   |
| <code>SCROLLER_ParentMsgHandler()</code>      | Message handler called from the callback of the SCROLLER's parent widget.  |
| <code>SCROLLER_PreventIntersect()</code>      | Automatically limits the movement area both SCROLLERS if a widget has a vertical and horizontal SCROLLER attached. |
| <code>SCROLLER_DeleteFromWindow</code>        | Automatically limits the movement area both SCROLLERS if a widget has a vertical and horizontal SCROLLER attached. |
| <code>SCROLLER_SetAlign()</code>              | Sets the given alignment of the SCROLLER.  |
| <code>SCROLLER_SetAlignOffset()</code>        | Sets the alignment offset to the SCROLLER rectangle in pixels.   |
| <code>SCROLLER_SetAnimEase()</code>           | Sets the animation ease for a given animation of the SCROLLER.   |
| <code>SCROLLER_SetBkColor()</code>            | Sets the background color of the SCROLLER widget.  |
| <code>SCROLLER_SetColor()</code>              | Sets the given color to the SCROLLER widget.   |
| <code>SCROLLER_SetDefaultAlign()</code>       | Set the given default alignment for newly created SCROLLER widgets.  |
| <code>SCROLLER_SetDefaultAlignOffset()</code> | Set the default alignment offset for newly created SCROLLER widgets.   |
| <code>SCROLLER_SetDefaultAnimEase()</code>    | Sets the default animation ease for a given animation for SCROLLER widgets.  |
| <code>SCROLLER_SetDefaultBkColor()</code>     | Sets the default background color of the SCROLLER widget.  |
| <code>SCROLLER_SetDefaultColor()</code>       | Sets the given default color for newly created SCROLLER widgets.   |
| <code>SCROLLER_SetDefaultPeriod()</code>      | Sets the given default period for newly created SCROLLER widgets.  |
| <code>SCROLLER_SetDefaultRadius()</code>      | Sets the default radius for newly created SCROLLER widgets.  |

| Routine  | Description   |
|--|---|
| <code>SCROLLER_SetDefaultThumbSizeMin()</code> | Sets the default minimum thumb size for newly created SCROLLER widgets.   |
| <code>SCROLLER_SetDefaultSize()</code>         | Sets the default width/height of the SCROLLER rectangle.  |
| <code>SCROLLER_SetDefaultSpacing()</code>      | Sets the default spacing used for newly created SCROLLER widgets.   |
| <code>SCROLLER_SetInterfaceAPI()</code>        | Sets the function pointers for the interface between the parent widget and the SCROLLER.                          |
| <code>SCROLLER_SetOwnerDraw()</code>           | Sets an application defined owner draw function for the widget which is responsible for drawing the SCROLLER bar. |
| <code>SCROLLER_SetPeriod()</code>              | Sets the given color to the SCROLLER widget.  |
| <code>SCROLLER_SetRadius()</code>              | Sets the radius of the SCROLLER widget.   |
| <code>SCROLLER_SetScrollState()</code>         | Sets the scroll state of the SCROLLER.  |
| <code>SCROLLER_SetSize()</code>                | Sets the thickness of the SCROLLER thumb rectangle.   |
| <code>SCROLLER_SetSpacing()</code>             | Sets the spacing for the SCROLLER widget.   |
| <code>SCROLLER_SetState()</code>               | Manually sets the state of the SCROLLER to active or inactive.  |
| <code>SCROLLER_SetThumbSizeMin()</code>        | Sets the minimum thumb size for the SCROLLER widget.  |
| <code>SCROLLER_SetUserData()</code>            | Sets the extra data of a SCROLLER widget.   |

## Data structures

| Structure                           | Description   |
|-------------------------------------|---|
| <code>SCROLLER_INTERFACE_API</code> | Interface API between the SCROLLER and its parent widget. |

## Defines

| Group of defines                        | Description  |
|---|--|
| <code>SCROLLER alignment indexes</code> | Alignment indexes for SCROLLER widgets.                          |
| <code>SCROLLER animation indexes</code> | Animation indexes used for <code>SCROLLER_SetAnimEase()</code> . |
| <code>SCROLLER color indexes</code>     | Color indexes for SCROLLER widgets.                              |
| <code>SCROLLER create flags</code>      | Create flags for SCROLLER widgets.                               |
| <code>SCROLLER period indexes</code>    | Period indexes for SCROLLER widgets.                             |

## 6.2.25.8.1 Functions

### 6.2.25.8.1.1 SCROLLER\_AttachToWindow()

#### Description

Attaches the given SCROLLER to a new parent window. The SCROLLER is resized according to new parent window.

#### Prototype

```
void SCROLLER_AttachToWindow(SCROLLER_Handle hObj,  
                             WM_HWIN       hNewParent);
```

#### Parameters

| Parameter               | Description                  |
|-------------------------|------------------------------|
| <code>hObj</code>       | Handle of SCROLLER widget.   |
| <code>hNewParent</code> | Handle of new parent window. |

#### Additional information

The new parent window will receive a `WM_NOTIFY_PARENT` message with `WM_NOTIFICATION_SCROLLER_ADDED` as the notification ID.

### 6.2.25.8.1.2 SCROLLER\_CreateAttached()

#### Description

Creates a scroll bar which is attached to an existing window.

#### Prototype

```
SCROLLER_Handle SCROLLER_CreateAttached(WM_HWIN hParent,
                                         int      ExFlags);
```

#### Parameters

| Parameter            | Description  |
|----------------------|--|
| <code>hParent</code> | Handle of parent window.   |
| <code>ExFlags</code> | Special creation flags. Permitted values are listed under <code>SCROLLER_CreateEx()</code> . |

#### Return value

- = 0      Creation of the SCROLLER failed e.g. because the parent widget already has a SCROLLER with the same orientation attached.
- ≠ 0     Handle of the created SCROLLER widget.

#### Additional information

An attached SCROLLER widget is essentially a child window which will position itself on the parent window and operate accordingly.

Vertically attached SCROLLER widgets will be automatically placed on the right side of the parent window; horizontal SCROLLER widgets on the bottom. Since no more than one horizontal and one vertical SCROLLER widget can be attached to a parent window, no ID needs to be passed as parameter. The following fixed ID's will automatically be assigned when an attached SCROLLER widget is created:

- `GUI_ID_HSCROLLER` for a horizontal SCROLLER widget
- `GUI_ID_VSCROLLER` for a vertical SCROLLER widget



### 6.2.25.8.1.3 SCROLLER\_CreateIndirect()

#### Description

Prototype explained at the beginning of the chapter as `<WIDGET>_CreateIndirect()` on page 992.

### 6.2.25.8.1.4 SCROLLER\_CreateUser()

#### Description

Creates a SCROLLER widget of a specified size at a specified location and allocates a given number of additional bytes.

#### Prototype

```
SCROLLER_Handle SCROLLER_CreateUser(int    x0,
                                     int    y0,
                                     int    xSize,
                                     int    ySize,
                                     WM_HWIN hParent,
                                     int    WinFlags,
                                     int    ExFlags,
                                     int    Id,
                                     int    NumExtraBytes);
```

#### Parameters

| Parameter             | Description  |
|-----------------------|--|
| <code>x0</code>       | Leftmost pixel of the widget (in parent coordinates).  |
| <code>y0</code>       | Topmost pixel of the widget (in parent coordinates).   |
| <code>xSize</code>    | Horizontal size of the widget (in pixels).   |
| <code>ySize</code>    | Vertical size of the widget (in pixels).   |
| <code>hParent</code>  | Handle of parent window. If 0, the new SCROLLER widget will be a child of the desktop (top-level window).  |
| <code>WinFlags</code> | Window create flags. Typically <code>WM_CF_SHOW</code> in order to make the widget visible immediately (refer to <i>Window create flags</i> on page 977 for a list of available parameter values). |
| <code>ExFlags</code>  | OR-combination of special creation flags. See <i>SCROLLER create flags</i> on page 2018 for a list of permitted values.  |
| <code>Id</code>       | Window ID of the widget.   |

#### Return value

- = 0      Creation of the SCROLLER failed e.g. because the parent widget already has a SCROLLER with the same orientation attached.
- ≠ 0     Handle of the created SCROLLER widget.

### 6.2.25.8.1.5 SCROLLER\_EnableAutoResize()

#### Description

Enables or disables automatic resizing of SCROLLER widgets.

Automatic resizing will come into effect if the two touch areas of a horizontal and vertical SCROLLER would collide. The two touch areas would only collide if the following is true:

- There is a vertical and horizontal SCROLLER attached to the parent widget.
- Both SCROLLERS are visible and have touch input enabled.

According to the given paramters, automatic resizing can be enabled or disabled and the desired SCROLLER to be resized can be set.

#### Prototype

```
void SCROLLER_EnableAutoResize(int EnableAutoResize,
                                int Vertical);
```

#### Parameters

| Parameter        | Description   |
|------------------|---|
| EnableAutoResize | 1 for enabling, 0 for disabling.  |
| Vertical         | 1 if vertical SCROLLER should be reduced in size, 0 if horizontal SCROLLER should be reduced in size. |

#### Additional information

Automatic resizing is enabled by default. The default is that horizontal SCROLLERS will be reduced in size.

#### Example

The example below demonstrates how SCROLLERS are resized if auto resizing is enabled. The client area of the vertical SCROLLER is marked green while the horizontal SCROLLER is marked red.

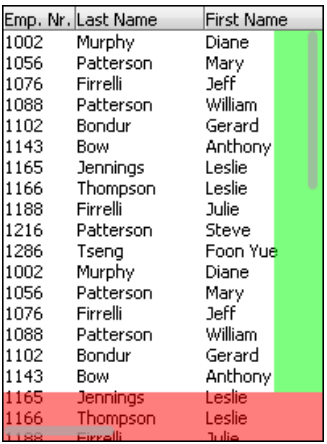
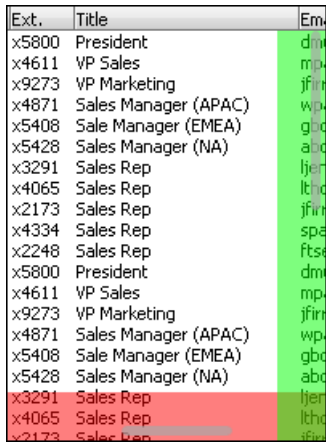
| Auto resize enabled for horizontal SCROLLER   | Auto resize enabled for vertical SCROLLER   | Auto resize disabled  |
|---|---|---|
|  |  |  |
| <pre>SCROLLER_EnableAutoResize(1, 0);</pre>   | <pre>SCROLLER_EnableAutoResize(1, 1);</pre>   | <pre>SCROLLER_EnableAutoResize(0, 0);</pre>   |
| The horizontal SCROLLER is reduced in size in favor of the vertical SCROLLER.       | The vertical SCROLLER is reduced in size in favor of the horizontal SCROLLER.       | Both SCROLLERS are not resized and the widgets overlap.                               |

### 6.2.25.8.1.6 SCROLLER\_EnableFade()

#### Description

Enables or disables fading mode for the SCROLLER widget.

#### Prototype

```
void SCROLLER_EnableFade(SCROLLER_Handle hObj,  
                          U8 OnOff);
```

#### Parameters

| Parameter          | Description                      |
|--------------------|----------------------------------|
| <code>hObj</code>  | SCROLLER handle.                 |
| <code>OnOff</code> | 1 for enabling, 0 for disabling. |

### 6.2.25.8.1.7 SCROLLER\_EnableTouch()

#### Description

Enables or disables touch input for the SCROLLER widget.

#### Prototype

```
void SCROLLER_EnableTouch(SCROLLER_Handle hObj,  
                           U8 OnOff);
```

#### Parameters

| Parameter          | Description                      |
|--------------------|----------------------------------|
| <code>hObj</code>  | SCROLLER handle.                 |
| <code>OnOff</code> | 1 for enabling, 0 for disabling. |

### 6.2.25.8.1.8 SCROLLER\_GetAlign()

#### Description

Returns the given alignment set to the SCROLLER widget.

#### Prototype

```
U8 SCROLLER_GetAlign(SCROLLER_Handle hObj,  
                     unsigned int   AlignIndex);
```

#### Parameters

| Parameter                  | Description   |
|----------------------------|---|
| <a href="#">hObj</a>       | SCROLLER handle.  |
| <a href="#">AlignIndex</a> | See <i>SCROLLER alignment indexes</i> on page 2015 for a full list of permitted values. |

#### Return value

≠ 0    Alignment set to SCROLLER widget.  
= 0    Error.

### 6.2.25.8.1.9 SCROLLER\_GetAlignOffset()

#### Description

Returns the alignment offset set to the SCROLLER rectangle.

#### Prototype

```
int SCROLLER_GetAlignOffset(SCROLLER_Handle hObj);
```

#### Parameters

| Parameter            | Description      |
|----------------------|------------------|
| <a href="#">hObj</a> | SCROLLER handle. |

#### Return value

Alignment offset of the SCROLLER rectangle in pixels.

### 6.2.25.8.1.10 SCROLLER\_GetAnimEase()

#### Description

Returns the animation ease for a given animation of the SCROLLER. More detailed information about animation ease can be read in the chapter "Animations" under *Position calculation* on page 615.

#### Prototype

```
GUI_ANIM_GETPOS_FUNC SCROLLER_GetAnimEase(SCROLLER_Handle hObj,  
                                           unsigned int   AnimIndex);
```

#### Parameters

| Parameter                 | Description   |
|---------------------------|---|
| <a href="#">hObj</a>      | Handle to a SCROLLER widget.                        |
| <a href="#">AnimIndex</a> | See <i>SCROLLER animation indexes</i> on page 2016. |

#### Return value

= NULL    Invalid parameters.  
≠ NULL    Pointer to position calculation function.



### 6.2.25.8.1.11 SCROLLER\_GetBkColor()

#### Description

Returns the background color of the SCROLLER widget.

#### Prototype

```
GUI_COLOR SCROLLER_GetBkColor(SCROLLER_Handle hObj,  
                               unsigned int   ColorIndex);
```

#### Parameters

| Parameter                  | Description   |
|----------------------------|---|
| <a href="#">hObj</a>       | Handle to a SCROLLER widget.  |
| <a href="#">ColorIndex</a> | See <i>SCROLLER color indexes</i> on page 2017 for a full list of permitted values. |

#### Return value

Returns the given background color of the SCROLLER widget.

### 6.2.25.8.1.12 SCROLLER\_GetColor()

#### Description

Returns the given color of the SCROLLER widget.

#### Prototype

```
GUI_COLOR SCROLLER_GetColor(SCROLLER_Handle hObj,  
                             unsigned int   ColorIndex);
```

#### Parameters

| Parameter                  | Description   |
|----------------------------|---|
| <a href="#">hObj</a>       | SCROLLER handle.  |
| <a href="#">ColorIndex</a> | See <i>SCROLLER color indexes</i> on page 2017 for a full list of permitted values. |

#### Return value

Given color set to the SCROLLER widget.

### 6.2.25.8.1.13 SCROLLER\_GetDefaultAlign()

#### Description

Returns the given default alignment for SCROLLER widgets.

#### Prototype

```
U8 SCROLLER_GetDefaultAlign(unsigned int AlignIndex);
```

#### Parameters

| Parameter                  | Description   |
|----------------------------|---|
| <a href="#">AlignIndex</a> | See <i>SCROLLER alignment indexes</i> on page 2015 for a full list of permitted values. |

#### Return value

≠ 0     The given default alignment for SCROLLER widgets.  
= 0     Error.

#### 6.2.25.8.1.14 SCROLLER\_GetDefaultAlignOffset()

##### Description

Returns the default alignment offset for newly created SCROLLER widgets.

##### Prototype

```
int SCROLLER_GetDefaultAlignOffset(void);
```

##### Return value

Default alignment offset.

### 6.2.25.8.1.15 SCROLLER\_GetDefaultAnimEase()

#### Description

Returns the default animation ease for a given animation for SCROLLER widgets.

#### Prototype

```
GUI_ANIM_GETPOS_FUNC SCROLLER_GetDefaultAnimEase(unsigned int AnimIndex);
```

#### Parameters

| Parameter                 | Description   |
|---------------------------|---|
| <a href="#">AnimIndex</a> | See <i>SCROLLER animation indexes</i> on page 2016. |

#### Return value

- = NULL Invalid parameters.
- ≠ NULL Pointer to position calculation function.

### 6.2.25.8.1.16 SCROLLER\_GetDefaultBkColor()

#### Description

Returns the default background color of the SCROLLER widget.

#### Prototype

```
GUI_COLOR SCROLLER_GetDefaultBkColor(unsigned int ColorIndex);
```

#### Parameters

| Parameter               | Description   |
|-------------------------|---|
| <code>ColorIndex</code> | See <i>SCROLLER color indexes</i> on page 2017 for a full list of permitted values. |

#### Return value

≠ GUI\_INVALID\_COLOR      Default background color.  
= GUI\_INVALID\_COLOR      Error.

### 6.2.25.8.1.17 SCROLLER\_GetDefaultColor()

#### Description

Returns the given default color for SCROLLER widgets.

#### Prototype

```
GUI_COLOR SCROLLER_GetDefaultColor(unsigned int ColorIndex);
```

#### Parameters

| Parameter               | Description   |
|-------------------------|---|
| <code>ColorIndex</code> | See <i>SCROLLER color indexes</i> on page 2017 for a full list of permitted values. |

#### Return value

≠ GUI\_INVALID\_COLOR      The given default color for SCROLLER widgets.  
= GUI\_INVALID\_COLOR      Error.

### 6.2.25.8.1.18 SCROLLER\_GetDefaultPeriod()

#### Description

Returns the given default period for SCROLLER widgets.

#### Prototype

```
int SCROLLER_GetDefaultPeriod(unsigned int PeriodIndex);
```

#### Parameters

| Parameter                   | Description  |
|-----------------------------|--|
| <a href="#">PeriodIndex</a> | See <i>SCROLLER period indexes</i> on page 2019 for a full list of permitted values. |

#### Return value

≠ -1 The given default period for SCROLLER widgets.  
= -1 Error.



### 6.2.25.8.1.19 SCROLLER\_GetDefaultRadius()

#### Description

Returns the default radius used for SCROLLER widgets.

#### Prototype

```
int SCROLLER_GetDefaultRadius(void);
```

#### Return value

Default radius for SCROLLER widgets.

### 6.2.25.8.1.20 SCROLLER\_GetDefaultThumbSizeMin()

#### Description

Returns the default minimum thumb size used for SCROLLER widgets.

#### Prototype

```
int SCROLLER_GetDefaultThumbSizeMin(void);
```

#### Return value

Default minimum thumb size used for SCROLLER widgets.

### 6.2.25.8.1.21 SCROLLER\_GetDefaultSize()

#### Description

Returns the default width/height used for the SCROLLER rectangle. This depends on whether the widget is vertical or horizontal.

#### Prototype

```
int SCROLLER_GetDefaultSize(void);
```

#### Return value

- Default width for the SCROLLER rectangle (if the widget is vertical).
- Default height for the SCROLLER rectangle (if the widget is horizontal).

### 6.2.25.8.1.22 SCROLLER\_GetDefaultSpacing()

#### Description

Returns the default spacing used for newly created SCROLLER widgets.

The spacing and thumb size are added to determine the overall height (if the SCROLLER is horizontal) or the overall width (if the SCROLLER is vertical) and therefore the touch area of the widget.

#### Prototype

```
int SCROLLER_GetDefaultSpacing(void);
```

#### Return value

Default spacing used for SCROLLER widgets.

### 6.2.25.8.1.23 SCROLLER\_GetPeriod()

#### Description

Returns the given period of the SCROLLER widget.

#### Prototype

```
int SCROLLER_GetPeriod(SCROLLER_Handle hObj,  
                       unsigned int   PeriodIndex);
```

#### Parameters

| Parameter                   | Description  |
|-----------------------------|--|
| <a href="#">hObj</a>        | SCROLLER handle.   |
| <a href="#">PeriodIndex</a> | See <i>SCROLLER period indexes</i> on page 2019 for a full list of permitted values. |

#### Return value

≠ -1    The given period in ms of the SCROLLER widget.  
= -1    Error.

### 6.2.25.8.1.24 SCROLLER\_GetRadius()

#### Description

Returns the radius of the SCROLLER widget.

#### Prototype

```
int SCROLLER_GetRadius(SCROLLER_Handle hObj);
```

#### Parameters

| Parameter            | Description      |
|----------------------|------------------|
| <a href="#">hObj</a> | SCROLLER handle. |

#### Return value

≠ -1     Radius of the SCROLLER widget.  
= -1     Error.

### 6.2.25.8.1.25 SCROLLER\_GetScrollState()

#### Description

Retrieves the current scroll state of the SCROLLER.

#### Prototype

```
void SCROLLER_GetScrollState(SCROLLER_Handle hObj,  
                             WM_SCROLL_STATE * pState);
```

#### Parameters

| Parameter           | Description                        |
|---------------------|------------------------------------|
| <code>hObj</code>   | Handle to a SCROLLER widget.       |
| <code>pState</code> | <code>out</code> New scroll state. |

### 6.2.25.8.1.26 SCROLLER\_GetSize()

#### Description

Returns the thickness of the SCROLLER thumb rectangle. Size refers to the width of the SCROLLER rectangle if the widget is vertical or height of the rectangle if the widget is horizontal.

#### Prototype

```
int SCROLLER_GetSize(SCROLLER_Handle hObj);
```

#### Parameters

| Parameter         | Description      |
|-------------------|------------------|
| <code>hObj</code> | SCROLLER handle. |

#### Return value

≠ -1    Size of the SCROLLER widget.  
= -1    Error.



### 6.2.25.8.1.27 SCROLLER\_GetSpacing()

#### Description

Returns the spacing of the SCROLLER widget.

The spacing and thumb size are added to determine the overall height (if the SCROLLER is horizontal) or the overall width (if the SCROLLER is vertical) and therefore the touch area of the widget.

#### Prototype

```
int SCROLLER_GetSpacing(SCROLLER_Handle hObj);
```

#### Parameters

| Parameter         | Description                  |
|-------------------|------------------------------|
| <code>hObj</code> | Handle to a SCROLLER widget. |

#### Return value

= -1     Error.  
≠ -1     Spacing of the SCROLLER.

### 6.2.25.8.1.28 SCROLLER\_GetThumbRect()

#### Description

Returns the current thumb rectangle in coordinates relative to the SCROLLER.

#### Prototype

```
void SCROLLER_GetThumbRect(SCROLLER_Handle hObj,  
                           GUI_RECT * pRect);
```

#### Parameters

| Parameter          | Description                                       |
|--------------------|---|
| <code>hObj</code>  | Handle to a SCROLLER widget.                      |
| <code>pRect</code> | <code>out</code> Pointer to a GUI_RECT structure. |

### 6.2.25.8.1.29 SCROLLER\_GetThumbSizeMin()

#### Description

Returns the minimum thumb size of the SCROLLER widget. Thumb size refers to the SCROLLER rectangle length if the widget is horizontal and the rectangle height if the widget is vertical.

#### Prototype

```
int SCROLLER_GetThumbSizeMin(SCROLLER_Handle hObj);
```

#### Parameters

| Parameter         | Description      |
|-------------------|------------------|
| <code>hObj</code> | SCROLLER handle. |

#### Return value

≠ -1 Minimum thumb size of the SCROLLER widget.  
= -1 Error.

### 6.2.25.8.1.30 SCROLLER\_GetUserData()

#### Description

Prototype explained at the beginning of the chapter as `<WIDGET>_GetUserData()` on page 994.

### 6.2.25.8.1.31 SCROLLER\_OwnerDraw()

#### Description

Default function for managing drawing operations of the SCROLLER widget.

#### Prototype

```
int SCROLLER_OwnerDraw(const WIDGET_ITEM_DRAW_INFO * pDrawItemInfo);
```

#### Parameters

| Parameter                  | Description  |
|----------------------------|--|
| <code>pDrawItemInfo</code> | <b>in</b> Pointer to a <code>WIDGET_ITEM_DRAW_INFO</code> structure. |

#### Return value

Depends on the command in the `Cmd` element of the `WIDGET_ITEM_DRAW_INFO` structure pointed to by `pDrawItemInfo`.

#### Additional information

This function is useful if `SCROLLER_SetOwnerDraw()` is used. It can be used to draw the thumb and background of the widget manually.

The following commands are managed by the default function (in the order of calling):

- `WIDGET_ITEM_DRAW_BACKGROUND`: Draws the background of the widget area.
- `WIDGET_ITEM_DRAW`: Draws the thumb.

#### WIDGET\_ITEM\_DRAW\_BACKGROUND

The following elements of the `WIDGET_ITEM_DRAW_INFO` structure are usable:

| Element                | Description   |
|------------------------|---|
| <code>hWin</code>      | Handle of SCROLLER widget.  |
| <code>x0</code>        | x0 of the background rectangle.   |
| <code>y0</code>        | y0 of the background rectangle.   |
| <code>x1</code>        | x1 of the background rectangle.   |
| <code>y1</code>        | y1 of the background rectangle.   |
| <code>ItemIndex</code> | -1 during fading animation, or color index which is listed under <i>SCROLLER color indexes</i> on page 2017.  |
| <code>P</code>         | Only if <code>ItemIndex = -1</code> (during fade animation): Pointer to an <code>I16</code> which contains the current animation position. This value ranges from 0 to <code>GUI_ANIM_RANGE</code> , while 0 equals the inactive state and <code>GUI_ANIM_RANGE</code> equals the active state. |

#### WIDGET\_ITEM\_DRAW

The following elements of the `WIDGET_ITEM_DRAW_INFO` structure are usable:

| Element                | Description  |
|------------------------|--|
| <code>hWin</code>      | Handle of SCROLLER widget.   |
| <code>x0</code>        | x0 of the thumb rectangle.*  |
| <code>y0</code>        | y0 of the thumb rectangle.*  |
| <code>x1</code>        | x1 of the thumb rectangle.*  |
| <code>y1</code>        | y1 of the thumb rectangle.*  |
| <code>ItemIndex</code> | -1 during fading animation, or color index which is listed under <i>SCROLLER color indexes</i> on page 2017. |

| Element | Description  |
|---------|--|
| P       | Only if ItemIndex = -1 (during fade animation): Pointer to an I16 which contains the current animation position. This value ranges from 0 to GUI_ANIM_RANGE, while 0 equals the inactive state and GUI_ANIM_RANGE equals the active state. |

\* High resolution coordinates. In order to convert them to pixel coordinates, scale down by 4. To retrieve the thumb rectangle in pixel coordinates, the function `SCROLLER_GetThumbRect()` can also be used.

### 6.2.25.8.1.32 SCROLLER\_ParentMsgHandler()

#### Description

Message handler called from the callback of the SCROLLER's parent widget.

**Note:** This function is only to be called when custom widgets or windows should support SCROLLER widgets.

#### Prototype

```
int SCROLLER_ParentMsgHandler(WM_MESSAGE * pMsg);
```

#### Parameters

| Parameter         | Description                                      |
|-------------------|--|
| <code>pMsg</code> | <code>in</code> Pointer to WM_MESSAGE structure. |

#### Return value

- 0 Message was handled.
- 1 Message was not handled.

#### Additional information

This routine handles the following messages:

- WM\_MOTION
- WM\_NOTIFY\_PARENT (WM\_NOTIFICATION\_SCROLLER\_ADDED and WM\_NOTIFICATION\_VALUE\_CHANGED).
- WM\_GET\_CONTENT\_RECT

**Important:** This message handler needs to be called **after** the parent widget's callback has handled the above messages. Also make sure that WM\_DefaultProc() does not handle the messages first.

### 6.2.25.8.1.33 SCROLLER\_PreventIntersect()

#### Description

Automatically limits the movement area both SCROLLERS if a widget has a vertical and horizontal SCROLLER attached. This will prevent over crossing of two SCROLLERS. This limit only comes into effect if both SCROLLER widgets are overlapping.

#### Prototype



```
void SCROLLER_PreventIntersect(int Enable);
```

#### Parameters

| Parameter              | Description                      |
|------------------------|----------------------------------|
| <a href="#">Enable</a> | 1 for enabling, 0 for disabling. |

#### Example

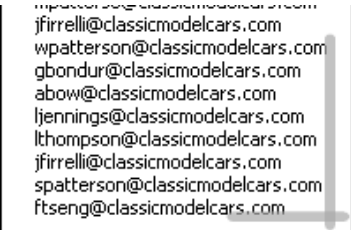
The example below demonstrates how the SCROLLERS are automatically prevented from crossing over each other.

| Disabled   | Enabled (default)   |
|--|---|
|  |  |



### 6.2.25.8.1.34 SCROLLER\_SetAlign()

#### Description

Sets the given alignment of the SCROLLER.

#### Prototype

```
void SCROLLER_SetAlign(SCROLLER_Handle hObj,  
                       unsigned int   AlignIndex,  
                       U8              Align);
```

#### Parameters

| Parameter                  | Description   |
|----------------------------|---|
| <a href="#">hObj</a>       | SCROLLER handle.  |
| <a href="#">AlignIndex</a> | See <i>SCROLLER alignment indexes</i> on page 2015 for a full list of permitted values. |
| <a href="#">Align</a>      | New alignment.  |

### 6.2.25.8.1.35 SCROLLER\_SetAlignOffset()

#### Description

Sets the alignment offset to the SCROLLER rectangle in pixels.

#### Prototype

```
void SCROLLER_SetAlignOffset(SCROLLER_Handle hObj,  
                             int Offset);
```

#### Parameters

| Parameter           | Description                |
|---------------------|----------------------------|
| <code>hObj</code>   | SCROLLER handle.           |
| <code>Offset</code> | Alignment offset in pixels |

### 6.2.25.8.1.36 SCROLLER\_SetAnimEase()

#### Description

Sets the animation ease for a given animation of the SCROLLER. More detailed information about animation ease can be read in the chapter "Animations" under *Position calculation* on page 615.

#### Prototype

```
void SCROLLER_SetAnimEase(SCROLLER_Handle hObj,  
                           unsigned int    AnimIndex,  
                           GUI_ANIM_GETPOS_FUNC pfEase);
```

#### Parameters

| Parameter                 | Description   |
|---------------------------|---|
| <a href="#">hObj</a>      | Handle to a SCROLLER widget.                        |
| <a href="#">AnimIndex</a> | See <i>SCROLLER animation indexes</i> on page 2016. |
| <a href="#">pfEase</a>    | Pointer to position calculation function.           |

### 6.2.25.8.1.37 SCROLLER\_SetBkColor()

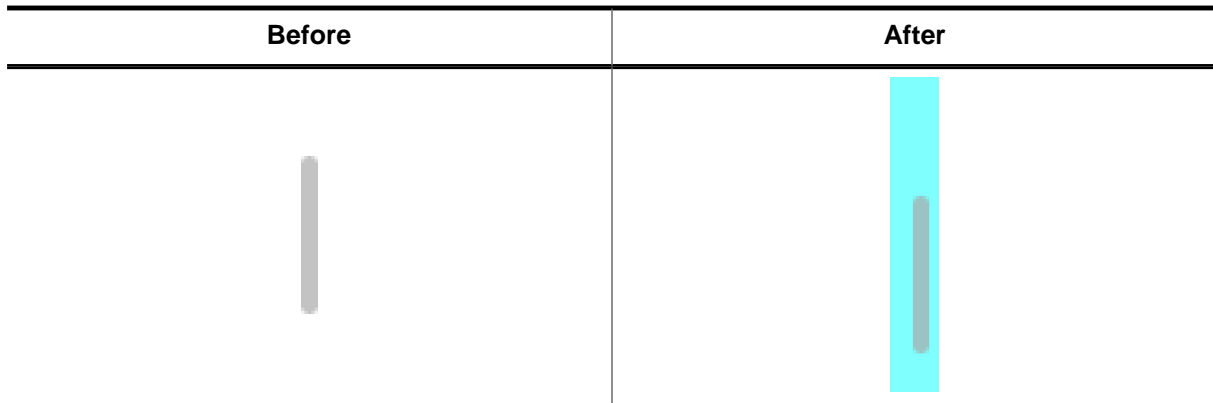

#### Description

Sets the background color of the SCROLLER widget.



#### Prototype

```
void SCROLLER_SetBkColor(SCROLLER_Handle hObj,
                        unsigned int      ColorIndex,
                        GUI_COLOR        BkColor);
```

#### Parameters

| Parameter               | Description   |
|-------------------------|---|
| <code>hObj</code>       | Handle to a SCROLLER widget.  |
| <code>ColorIndex</code> | See <i>SCROLLER color indexes</i> on page 2017 for a full list of permitted values. |
| <code>BkColor</code>    | New background color.   |

### 6.2.25.8.1.38 SCROLLER\_SetColor()

| Before  | After   |
|---|---|
|  |  |

#### Description

Sets the given color to the SCROLLER widget.

#### Prototype

```
void SCROLLER_SetColor(SCROLLER_Handle hObj,
                       unsigned int   ColorIndex,
                       GUI_COLOR      Color);
```

#### Parameters

| Parameter               | Description   |
|-------------------------|---|
| <code>hObj</code>       | SCROLLER handle.  |
| <code>ColorIndex</code> | See <i>SCROLLER color indexes</i> on page 2017 for a full list of permitted values. |
| <code>Color</code>      | New color.  |

### 6.2.25.8.1.39 SCROLLER\_SetDefaultAlign()

#### Description

Set the given default alignment for newly created SCROLLER widgets.

#### Prototype

```
void SCROLLER_SetDefaultAlign(unsigned int AlignIndex,  
                               U8          Align);
```

#### Parameters

| Parameter                  | Description   |
|----------------------------|---|
| <a href="#">AlignIndex</a> | See <i>SCROLLER alignment indexes</i> on page 2015 for a full list of permitted values. |
| <a href="#">Align</a>      | New alignment.  |

#### 6.2.25.8.1.40 SCROLLER\_SetDefaultAlignOffset()

##### Description

Set the default alignment offset for newly created SCROLLER widgets.

##### Prototype

```
void SCROLLER_SetDefaultAlignOffset(int Offset);
```

##### Parameters

| Parameter           | Description           |
|---------------------|-----------------------|
| <code>Offset</code> | New alignment offset. |

#### 6.2.25.8.1.41 SCROLLER\_SetDefaultAnimEase()

##### Description

Sets the default animation ease for a given animation for SCROLLER widgets.

##### Prototype

```
void SCROLLER_SetDefaultAnimEase(unsigned int AnimIndex,  
GUI_ANIM_GETPOS_FUNC pfEase);
```

##### Parameters

| Parameter                 | Description   |
|---------------------------|---|
| <a href="#">AnimIndex</a> | See <i>SCROLLER animation indexes</i> on page 2016. |
| <a href="#">pfEase</a>    | <b>in</b> Pointer to position calculation function. |



#### 6.2.25.8.1.42 SCROLLER\_SetDefaultBkColor()

##### Description

Sets the default background color of the SCROLLER widget.

##### Prototype

```
void SCROLLER_SetDefaultBkColor(unsigned int ColorIndex,  
                                GUI_COLOR   BkColor);
```

##### Parameters

| Parameter                  | Description   |
|----------------------------|---|
| <a href="#">ColorIndex</a> | See <i>SCROLLER color indexes</i> on page 2017 for a full list of permitted values. |
| <a href="#">BkColor</a>    | New default background color.   |

### 6.2.25.8.1.43 SCROLLER\_SetDefaultColor()

#### Description

Sets the given default color for newly created SCROLLER widgets.

#### Prototype

```
void SCROLLER_SetDefaultColor(unsigned int ColorIndex,  
                             GUI_COLOR   Color);
```

#### Parameters

| Parameter               | Description   |
|-------------------------|---|
| <code>ColorIndex</code> | See <i>SCROLLER color indexes</i> on page 2017 for a full list of permitted values. |
| <code>Color</code>      | New color.  |

#### 6.2.25.8.1.44 SCROLLER\_SetDefaultPeriod()

##### Description

Sets the given default period for newly created SCROLLER widgets.

##### Prototype

```
void SCROLLER_SetDefaultPeriod(unsigned int PeriodIndex,  
                               int          Period);
```

##### Parameters

| Parameter                   | Description  |
|-----------------------------|--|
| <a href="#">PeriodIndex</a> | See <i>SCROLLER period indexes</i> on page 2019 for a full list of permitted values. |
| <a href="#">Period</a>      | New period. Must be $\geq 0$ .   |

#### 6.2.25.8.1.45 SCROLLER\_SetDefaultRadius()

##### Description

Sets the default radius for newly created SCROLLER widgets.

##### Prototype

```
void SCROLLER_SetDefaultRadius(int Radius);
```

##### Parameters

| Parameter | Description  |
|-----------|--|
| Radius    | New radius to be used for the SCROLLER rectangle. Must be $\geq 0$ . |

#### 6.2.25.8.1.46 SCROLLER\_SetDefaultThumbSizeMin()

##### Description

Sets the default minimum thumb size for newly created SCROLLER widgets.

##### Prototype

```
void SCROLLER_SetDefaultThumbSizeMin(int ThumbSize);
```

##### Parameters

| Parameter              | Description  |
|------------------------|--|
| <code>ThumbSize</code> | Minimum thumb size used for SCROLLER widgets. Must be $\geq 1$ . |

### 6.2.25.8.1.47 SCROLLER\_SetDefaultSize()

#### Description

Sets the default width/height of the SCROLLER rectangle. This depends on whether the widget is vertical or horizontal.

#### Prototype

```
void SCROLLER_SetDefaultSize(int Size);
```

#### Parameters

| Parameter         | Description  |
|-------------------|--|
| <code>Size</code> | Default width/height used for SCROLLER widgets. Must be $\geq 1$ . |

### 6.2.25.8.1.48 SCROLLER\_SetDefaultSpacing()

#### Description

Sets the default spacing used for newly created SCROLLER widgets.

The spacing and thumb size are added to determine the overall height (if the SCROLLER is horizontal) or the overall width (if the SCROLLER is vertical) and therefore the touch area of the widget.

#### Prototype

```
void SCROLLER_SetDefaultSpacing(int Spacing);
```

#### Parameters

| Parameter               | Description   |
|-------------------------|---|
| <a href="#">Spacing</a> | New spacing used for SCROLLER widgets. Must be $\geq 0$ . |

### 6.2.25.8.1.49 SCROLLER\_SetInterfaceAPI()

#### Description

Sets the function pointers for the interface between the parent widget and the SCROLLER.

**Note:** This function is only necessary for attaching SCROLLER widgets to custom widgets or windows.

#### Prototype

```
void SCROLLER_SetInterfaceAPI(      SCROLLER_Handle      hObj,  
                                   const SCROLLER_INTERFACE_API * pAPI);
```

#### Parameters

| Parameter         | Description   |
|-------------------|---|
| <code>hObj</code> | Handle to a SCROLLER widget.  |
| <code>pAPI</code> | <b>in</b> Pointer to a SCROLLER_INTERFACE_API structure. The structure pointed to has to stay persistent in memory! |



### 6.2.25.8.1.50 SCROLLER\_SetOwnerDraw()

#### Description

Sets an application defined owner draw function for the widget which is responsible for drawing the SCROLLER bar.

#### Prototype

```
void SCROLLER_SetOwnerDraw(SCROLLER_Handle hObj,  
                           WIDGET_DRAW_ITEM_FUNC * pfOwnerDraw);
```

#### Parameters

| Parameter                | Description                     |
|--------------------------|---------------------------------|
| <code>hObj</code>        | Handle to a SCROLLER widget.    |
| <code>pfOwnerDraw</code> | Pointer to owner draw function. |

#### Additional information

This function sets a pointer to an application defined function which will be called by the widget when a cell has to be drawn or when the x or y size of a item is needed. It gives you the possibility to draw anything as data item, not just plain text. `pfDrawItem` is a pointer to an application-defined function of type `WIDGET_DRAW_ITEM_FUNC` which is explained at the beginning of the chapter. Also, please refer to `SCROLLER_OwnerDraw()`.

### 6.2.25.8.1.51 SCROLLER\_SetPeriod()

#### Description

Sets the given color to the SCROLLER widget.



#### Prototype

```
void SCROLLER_SetPeriod(SCROLLER_Handle hObj,  
                        unsigned int   PeriodIndex,  
                        int            Period);
```

#### Parameters

| Parameter                | Description  |
|--------------------------|--|
| <code>hObj</code>        | SCROLLER handle.   |
| <code>PeriodIndex</code> | See <i>SCROLLER period indexes</i> on page 2019 for a full list of permitted values.                     |
| <code>Period</code>      | New period in ms, must be $\geq 0$ . A period of 0 will prevent the use of the given animation or timer. |

### 6.2.25.8.1.52 SCROLLER\_SetRadius()

| Before  | After   |
|---|---|
|  |  |

#### Description

Sets the radius of the SCROLLER widget.

#### Prototype

```
void SCROLLER_SetRadius(SCROLLER_Handle hObj,
                        int Radius);
```

#### Parameters

| Parameter              | Description                    |
|------------------------|--------------------------------|
| <a href="#">hObj</a>   | SCROLLER handle.               |
| <a href="#">Radius</a> | New radius. Must be $\geq 0$ . |

#### Additional information

If the radius is too large that no rounded rectangle with the given rectangle height/width can be drawn, the rectangle is drawn without rounded corners instead.

### 6.2.25.8.1.53 SCROLLER\_SetScrollState()

#### Description

Sets the scroll state of the SCROLLER.

#### Prototype

```
void SCROLLER_SetScrollState(SCROLLER_Handle hObj,  
                             WM_SCROLL_STATE * pState);
```

#### Parameters

| Parameter           | Description                                       |
|---------------------|---|
| <code>hObj</code>   | Handle to a SCROLLER widget.                      |
| <code>pState</code> | <b>in</b> Pointer to a WM_SCROLL_STATE structure. |

### 6.2.25.8.1.54 SCROLLER\_SetSize()

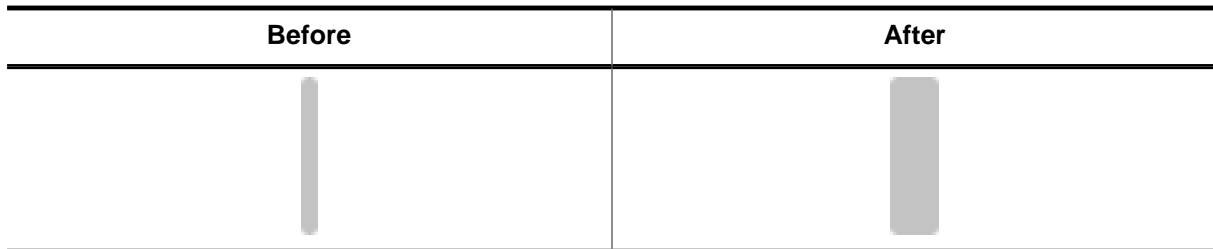

#### Description

Sets the thickness of the SCROLLER thumb rectangle.

**Vertical SCROLLERS:** Width of the thumb rectangle.

**Horizontal SCROLLERS:** Height of the thumb rectangle.

#### Prototype

```
void SCROLLER_SetSize(SCROLLER_Handle hObj,
                      int              Size);
```

#### Parameters

| Parameter | Description                  |
|-----------|------------------------------|
| hObj      | SCROLLER handle.             |
| Size      | New size. Must be $\geq 0$ . |

#### Additional information

A new widget size will be set automatically. The widget size is calculated as shown below:

- **Vertical SCROLLERS:** Widget xSize = size + spacing
- **Horizontal SCROLLERS:** Widget ySize = size + spacing

### 6.2.25.8.1.55 SCROLLER\_SetSpacing()

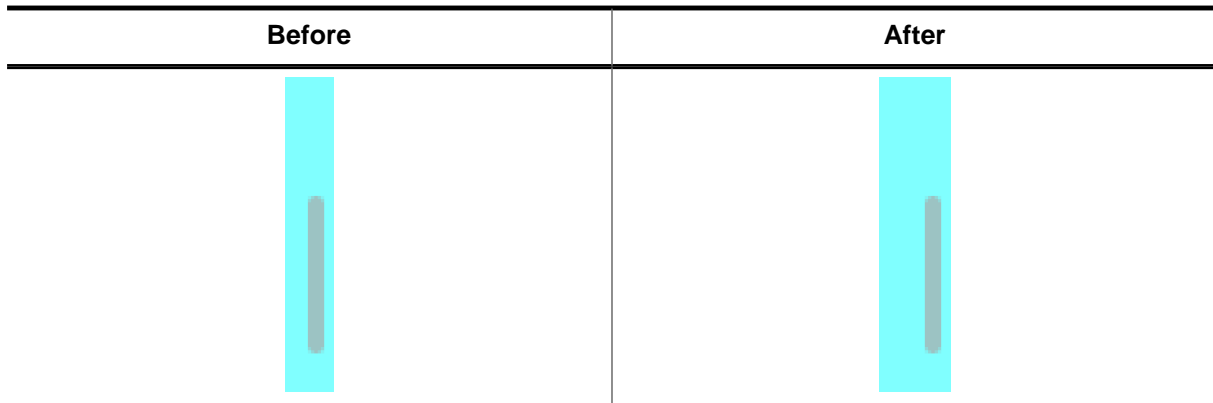

#### Description

Sets the spacing for the SCROLLER widget. The spacing is the empty part of the SCROLLER widget area that is not part of the thumb rectangle.

#### Prototype

```
void SCROLLER_SetSpacing(SCROLLER_Handle hObj,
                        int Spacing);
```

#### Parameters

| Parameter            | Description   |
|----------------------|---|
| <code>hObj</code>    | Handle to a SCROLLER widget.                        |
| <code>Spacing</code> | New spacing for SCROLLER widget. Must be $\geq 0$ . |

#### Additional information

A new widget size will be set automatically. The widget size is calculated as shown below:

- **Vertical SCROLLERS:** Widget `xSize` = size + spacing
- **Horizontal SCROLLERS:** Widget `ySize` = size + spacing

### 6.2.25.8.1.56 SCROLLER\_SetState()

#### Description

Manually sets the state of the SCROLLER to active or inactive.

When setting the state to active, the inactive timer will be started automatically. The timer will not be started if the parameter `NoTimer` is set to 1.

#### Prototype

```
void SCROLLER_SetState(SCROLLER_Handle hObj,
                       U8               Active,
                       U8               NoTimer);
```

#### Parameters

| Parameter            | Description  |
|----------------------|--|
| <code>hObj</code>    | SCROLLER handle.   |
| <code>Active</code>  | 1 for active, 0 for inactive.  |
| <code>NoTimer</code> | If 1 and <code>Active</code> = 1, the inactive timer will not be started. The SCROLLER would then stay in the active state until normal interaction will start the inactive timer again (e.g. moving the SCROLLER by touch and releasing touch). |

#### Additional information

This routine's main purpose is to be used when SCROLLERS are attached to custom widgets. The routine can be used to manually set the appearance of the SCROLLER to active, when e.g. the parent's scroll state was changed by key inputs, or some other input that is not normal touch input.

### 6.2.25.8.1.57 SCROLLER\_SetThumbSizeMin()

#### Description

Sets the minimum thumb size for the SCROLLER widget. Thumb size refers to the SCROLLER rectangle length if the widget is horizontal and the rectangle height if the widget is vertical.

#### Prototype

```
void SCROLLER_SetThumbSizeMin(SCROLLER_Handle hObj,  
                               int ThumbSize);
```

#### Parameters

| Parameter              | Description   |
|------------------------|---|
| <code>hObj</code>      | SCROLLER handle.  |
| <code>ThumbSize</code> | New minimum thumb size of the SCROLLER widget. Must be $\geq 1$ . |



### 6.2.25.8.1.58 SCROLLER\_SetUserData()

#### Description

Prototype explained at the beginning of the chapter as `<WIDGET>_SetUserData()` on page 995.

## 6.2.25.8.2 Data structures

### 6.2.25.8.2.1 SCROLLER\_INTERFACE\_API

#### Description

Interface API between the SCROLLER and its parent widget.

This structure is only needed when attaching SCROLLERS to custom widgets or windows.

See also the function `SCROLLER_SetInterfaceAPI()`.

#### Type definition

```
typedef struct {
    void (* pfUpdateScrollPos)(WM_HWIN hParent, SCROLLER_Handle hScroller);
    void (* pfScrollerAdded) (WM_HWIN hParent, SCROLLER_Handle hScroller);
    void (* pfValueChanged) (WM_HWIN hParent, SCROLLER_Handle hScroller, WM_SCROLL_STATE * pNewState);
    void (* pfGetContentRect) (WM_HWIN hParent, GUI_RECT * pRect);
} SCROLLER_INTERFACE_API;
```

#### Structure members

| Member                         | Description   |
|--------------------------------|---|
| <code>pfUpdateScrollPos</code> | Routine for setting the scroll state of the parent widget to the SCROLLER.  |
| <code>pfScrollerAdded</code>   | Routine that is called when the parent receives the <code>WM_NOTIFY_PARENT</code> message with a <code>WM_NOTIFICATION_SCROLLER_ADDED</code> notification.  |
| <code>pfValueChanged</code>    | Routine that is called when the parent receives the <code>WM_NOTIFY_PARENT</code> message with a <code>WM_NOTIFICATION_VALUE_CHANGED</code> notification sent by SCROLLER widgets. This routine sets the new scroll state of the SCROLLER to the parent widget. |
| <code>pfGetContentRect</code>  | Routine for retrieving the content rectangle of the parent, called when parent receives a <code>WM_GET_CONTENT_RECT</code> message.   |

### 6.2.25.8.3 Defines

#### 6.2.25.8.3.1 SCROLLER alignment indexes

##### Description

Alignment indexes for SCROLLER widgets.

##### Definition

```
#define SCROLLER_AI_WIDGETPOS    0
#define SCROLLER_AI_THUMB       1
```

##### Symbols

| Definition                            | Description  |
|---------------------------------------|--|
| <a href="#">SCROLLER_AI_WIDGETPOS</a> | The alignment of the SCROLLER widget within its parent widget (left or right, bottom or top).  |
| <a href="#">SCROLLER_AI_THUMB</a>     | The alignment of the thumb rectangle within the SCROLLER widget.<br>Allowed values for vertical SCROLLERS:<br>GUI_ALIGN_LEFT, GUI_ALIGN_HCENTER, GUI_ALIGN_RIGHT<br>Allowed values for horizontal SCROLLERS:<br>GUI_ALIGN_TOP, GUI_ALIGN_VCENTER, GUI_ALIGN_BOTTOM |

### 6.2.25.8.3.2 SCROLLER animation indexes

#### Description

Animation indexes used for `SCROLLER_SetAnimEase()`.

#### Definition

```
#define SCROLLER_ANIM_FADE      0
#define SCROLLER_ANIM_SCROLL   1
```

#### Symbols

| Definition                           | Description  |
|--------------------------------------|--|
| <a href="#">SCROLLER_ANIM_FADE</a>   | Animation for fading between the active and inactive state.  |
| <a href="#">SCROLLER_ANIM_SCROLL</a> | Animation for animating the scroll state when the SCROLLER was clicked outside of the thumb rectangle. |

### 6.2.25.8.3.3 SCROLLER color indexes

#### Description

Color indexes for SCROLLER widgets.

#### Definition

```
#define SCROLLER_CI_ACTIVE      0
#define SCROLLER_CI_INACTIVE   1
```

#### Symbols

| Definition                           | Description   |
|--------------------------------------|---|
| <a href="#">SCROLLER_CI_ACTIVE</a>   | Color for active state (when the scroller is moving or receives touch input). |
| <a href="#">SCROLLER_CI_INACTIVE</a> | Color for inactive state.   |

### 6.2.25.8.3.4 SCROLLER create flags

#### Description

Create flags for SCROLLER widgets.

#### Definition

```
#define SCROLLER_CF_FADING      (1 << 0)
#define SCROLLER_CF_TOUCH      (1 << 1)
#define SCROLLER_CF_VERTICAL    (1 << 3)
#define SCROLLER_CF_HORIZONTAL (0 << 3)
```

#### Symbols

| Definition                             | Description   |
|--|---|
| <a href="#">SCROLLER_CF_FADING</a>     | Enables automatic fading between the active and inactive state of the SCROLLER. |
| <a href="#">SCROLLER_CF_TOUCH</a>      | Enables touch input for the SCROLLER.   |
| <a href="#">SCROLLER_CF_VERTICAL</a>   | Creates a vertical SCROLLER.  |
| <a href="#">SCROLLER_CF_HORIZONTAL</a> | Creates a horizontal SCROLLER.  |

### 6.2.25.8.3.5 SCROLLER period indexes

#### Description

Period indexes for SCROLLER widgets.

#### Definition

```
#define SCROLLER_PI_FADE_IN      0
#define SCROLLER_PI_FADE_OUT    1
#define SCROLLER_PI_INACTIVE    2
#define SCROLLER_PI_ANIM_SCROLL 3
```

#### Symbols

| Definition                              | Description   |
|---|---|
| <a href="#">SCROLLER_PI_FADE_IN</a>     | The length in ms for fading in, from inactive to active color.                              |
| <a href="#">SCROLLER_PI_FADE_OUT</a>    | The length in ms for fading out, from active color to inactive color.                       |
| <a href="#">SCROLLER_PI_INACTIVE</a>    | Period it takes from releasing the widget until the fade operation is started.              |
| <a href="#">SCROLLER_PI_ANIM_SCROLL</a> | Period for animating the changing of the scroll state when the SCROLLER was moved by touch. |

## 6.2.26 SLIDER: Slider widget

SLIDER widgets are commonly used for modifying values through the use of a slider bar. The widget consists of a slider bar and tick marks beside the bar. These tick marks can be used to snap the slider bar while dragging it. For details about how to use the tick marks for snapping refer to the function `SLIDER_SetRange()`.

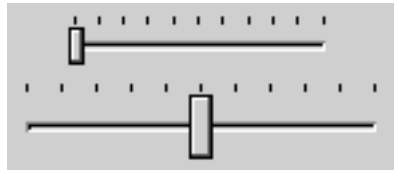

### Note

All SLIDER-related routines are located in the file(s) `SLIDER*.c`, `SLIDER.h`. All identifiers are prefixed `SLIDER`.

### Skinning...



...is available for this widget. The screenshot above shows the widget using the default skin. Details can be found in the chapter *Skinning* on page 2509.

### 6.2.26.1 Configuration options

| Type | Macro                                  | Default                | Description                                      |
|------|--|------------------------|--|
| N    | <code>SLIDER_BKCOLOR0_DEFAULT</code>   | <code>0xc0c0c0</code>  | Background color.                                |
| N    | <code>SLIDER_COLOR0_DEFAULT</code>     | <code>0xc0c0c0</code>  | Slider (thumb) color.                            |
| N    | <code>SLIDER_FOCUSCOLOR_DEFAULT</code> | <code>GUI_BLACK</code> | Default color for rendering the focus rectangle. |

### 6.2.26.2 Predefined IDs

The following symbols define IDs which may be used to make SLIDER widgets distinguishable from creation.

```
#define GUI_ID_SLIDER0    0x130
#define GUI_ID_SLIDER1    0x131
#define GUI_ID_SLIDER2    0x132
#define GUI_ID_SLIDER3    0x133
#define GUI_ID_SLIDER4    0x134
#define GUI_ID_SLIDER5    0x135
#define GUI_ID_SLIDER6    0x136
#define GUI_ID_SLIDER7    0x137
#define GUI_ID_SLIDER8    0x138
#define GUI_ID_SLIDER9    0x139
```



### 6.2.26.3 Notification codes

The following events are sent from a SLIDER widget to its parent window as part of a WM\_NOTIFY\_PARENT message:

| Message                       | Description   |
|-------------------------------|---|
| WM_NOTIFICATION_CLICKED       | SLIDER widget has been clicked.                             |
| WM_NOTIFICATION_RELEASED      | SLIDER widget has been released.                            |
| WM_NOTIFICATION_VALUE_CHANGED | Value of the SLIDER widget has changed by moving the thumb. |

#### 6.2.26.3.1 Keyboard reaction

The widget reacts to the following keys if it has the input focus:

| Key           | Description  |
|---------------|--|
| GUI_KEY_RIGHT | Increments the current value of the SLIDER widget by one item. |
| GUI_KEY_LEFT  | Decrements the current value of the SLIDER widget by one item. |

### 6.2.26.4 SLIDER API

The table below lists the available emWin SLIDER-related routines in alphabetical order. Detailed descriptions of the routines follow.

#### Functions

| Routine                                       | Description   |
|---|---|
| <a href="#">SLIDER_Create()</a>               | Creates a SLIDER widget. (Obsolete)                                     |
| <a href="#">SLIDER_CreateEx()</a>             | Creates a SLIDER widget.  |
| <a href="#">SLIDER_CreateIndirect()</a>       | Creates a SLIDER widget from resource table entry.                      |
| <a href="#">SLIDER_CreateUser()</a>           | Creates a SLIDER widget using extra bytes as user data.                 |
| <a href="#">SLIDER_Dec()</a>                  | Decrements the value of the SLIDER widget.                              |
| <a href="#">SLIDER_EnableFocusRect()</a>      | Enables or disables the focus rectangle.                                |
| <a href="#">SLIDER_GetBkColor()</a>           | Returns the background color of the SLIDER widget.                      |
| <a href="#">SLIDER_GetFocusColor()</a>        | Return the color focus rectangle of the SLIDER widget.                  |
| <a href="#">SLIDER_GetRange()</a>             | The function returns the range of the given SLIDER widget.              |
| <a href="#">SLIDER_GetUserData()</a>          | Returns the data set with <a href="#">SLIDER_SetUserData()</a> .        |
| <a href="#">SLIDER_GetValue()</a>             | Returns the current value of the SLIDER widget.                         |
| <a href="#">SLIDER_Inc()</a>                  | Increments the value of the SLIDER widget.                              |
| <a href="#">SLIDER_SetBkColor()</a>           | Sets the background color of the SLIDER widget.                         |
| <a href="#">SLIDER_SetDefaultFocusColor()</a> | Sets the default focus rectangle color for new SLIDER widgets.          |
| <a href="#">SLIDER_SetFocusColor()</a>        | Sets the color used to render the focus rectangle of the SLIDER widget. |
| <a href="#">SLIDER_SetInvertDir()</a>         | This function inverts the slider.                                       |

| <b>Routine</b>                    | <b>Description</b>                                  |
|-----------------------------------|---|
| <code>SLIDER_SetNumTicks()</code> | Sets the number of tick marks of the SLIDER widget. |
| <code>SLIDER_SetRange()</code>    | Sets the range of the SLIDER widget.                |
| <code>SLIDER_SetUserData()</code> | Sets the extra data of a SLIDER widget.             |
| <code>SLIDER_SetValue()</code>    | Sets the current value of the SLIDER widget.        |
| <code>SLIDER_SetWidth()</code>    | Sets the width of the SLIDER widget.                |

## Defines

| <b>Group of defines</b>          | <b>Description</b>              |
|----------------------------------|---------------------------------|
| <code>SLIDER create flags</code> | Create flags for SLIDER widget. |

## 6.2.26.4.1 Functions

### 6.2.26.4.1.1 SLIDER\_Create()

#### Note

This function is **deprecated**, `SLIDER_CreateEx()` should be used instead.

#### Description

Creates a SLIDER widget of a specified size at a specified location.

#### Prototype

```
SLIDER_Handle SLIDER_Create(int    x0,
                             int    y0,
                             int    xSize,
                             int    ySize,
                             WM_HWIN hParent,
                             int    Id,
                             int    WinFlags,
                             int    SpecialFlags);
```

#### Parameters

| Parameter                 | Description  |
|---------------------------|--|
| <code>x0</code>           | Leftmost pixel of the slider (in parent coordinates).  |
| <code>y0</code>           | Topmost pixel of the slider (in parent coordinates).   |
| <code>xSize</code>        | Horizontal size of the slider (in pixels).   |
| <code>ySize</code>        | Vertical size of the slider (in pixels).   |
| <code>hParent</code>      | Handle of the parent window.   |
| <code>Id</code>           | <code>Id</code> to be returned   |
| <code>WinFlags</code>     | Window create flags. Typically <code>WM_CF_SHOW</code> in order to make the widget visible immediately (refer to <i>Window create flags</i> on page 977 for a list of available parameter values). |
| <code>SpecialFlags</code> | Special creation flag (see indirect creation flag under <i>SLIDER_CreateIndirect</i> on page 2025).  |

#### Return value

Handle of the created SLIDER widget; 0 if the function fails.

### 6.2.26.4.1.2 SLIDER\_CreateEx()

#### Description

Creates a SLIDER widget of a specified size at a specified location.

#### Prototype

```
SLIDER_Handle SLIDER_CreateEx(int    x0,
                               int    y0,
                               int    xSize,
                               int    ySize,
                               WM_HWIN hParent,
                               int    WinFlags,
                               int    ExFlags,
                               int    Id);
```

#### Parameters

| Parameter             | Description  |
|-----------------------|--|
| <code>x0</code>       | Leftmost pixel of the widget (in parent coordinates).  |
| <code>y0</code>       | Topmost pixel of the widget (in parent coordinates).   |
| <code>xSize</code>    | Horizontal size of the widget (in pixels).   |
| <code>ySize</code>    | Vertical size of the widget (in pixels).   |
| <code>hParent</code>  | Handle of the parent window. If 0, the new SLIDER widget will be a child of the desktop (top-level window).  |
| <code>WinFlags</code> | Window create flags. Typically <code>WM_CF_SHOW</code> in order to make the widget visible immediately (refer to <i>Window create flags</i> on page 977 for a list of available parameter values). |
| <code>ExFlags</code>  | See <i>SLIDER create flags</i> on page 2044.   |
| <code>Id</code>       | Window ID of the widget.   |

#### Return value

Handle of the created SLIDER widget; 0 if the function fails.

### 6.2.26.4.1.3 SLIDER\_CreateIndirect()

#### Description

The prototype of this function is explained at the beginning of this chapter. Details can be found in the description of the function `<WIDGET>_CreateIndirect()` on page 992. The element `Para` of the according `GUI_WIDGET_CREATE_INFO` structure is not used. The element `Flags` is used according to the parameter `ExFlags` of the function `SLIDER_CreateEx()`.

#### 6.2.26.4.1.4 SLIDER\_CreateUser()

##### Description

Prototype explained at the beginning of the chapter as `<WIDGET>_CreateUser()` on page 993. For a detailed description of the parameters the function `SLIDER_CreateEx()` can be referred to.

### 6.2.26.4.1.5 SLIDER\_Dec()

#### Description

Decrements the current value of the SLIDER widget by one item.

#### Prototype

```
void SLIDER_Dec(SLIDER_Handle hObj);
```

#### Parameters

| Parameter         | Description              |
|-------------------|--------------------------|
| <code>hObj</code> | Handle of SLIDER widget. |

### 6.2.26.4.1.6 SLIDER\_EnableFocusRect()

#### Description

This function enables or disables the rectangle shown when a slider has the focus.

#### Prototype

```
void SLIDER_EnableFocusRect (SLIDER_Handle hObj,  
                             int           OnOff);
```

#### Parameters

| Parameter          | Description                                 |
|--------------------|---|
| <code>hObj</code>  | Handle of SLIDER widget.                    |
| <code>OnOff</code> | Enables (1) or disables (0) the focus rect. |



### 6.2.26.4.1.7 SLIDER\_GetBkColor()

#### Description

Returns the background color of the SLIDER widget.

#### Prototype

```
GUI_COLOR SLIDER_GetBkColor(SLIDER_Handle hObj);
```

#### Parameters

| Parameter            | Description              |
|----------------------|--------------------------|
| <a href="#">hObj</a> | Handle of SLIDER widget. |

#### Return value

The background color of the SLIDER widget.

### 6.2.26.4.1.8 SLIDER\_GetFocusColor()

#### Description

Return the color focus rectangle of the SLIDER widget.

#### Prototype

```
GUI_COLOR SLIDER_GetFocusColor(SLIDER_Handle hObj);
```

#### Parameters

| Parameter            | Description              |
|----------------------|--------------------------|
| <a href="#">hObj</a> | Handle of SLIDER widget. |

#### Return value

The color of the focus rectangle of the SLIDER widget.

### 6.2.26.4.1.9 SLIDER\_GetRange()

#### Description

The function returns the range of the given SLIDER widget.

#### Prototype

```
void SLIDER_GetRange(SLIDER_Handle hObj,  
                    int * pMin,  
                    int * pMax);
```

#### Parameters

| Parameter            | Description   |
|----------------------|---|
| <a href="#">hObj</a> | Handle of SLIDER widget.  |
| <a href="#">pMin</a> | Pointer to an int to be used to return the min-value. Should not be NULL. |
| <a href="#">pMax</a> | Pointer to an int to be used to return the max-value. Should not be NULL. |

#### 6.2.26.4.1.10 SLIDER\_GetUserData()

##### Description

Prototype explained at the beginning of the chapter as `<WIDGET>_GetUserData()` on page 994.

#### 6.2.26.4.1.11 SLIDER\_GetValue()

##### Description

Returns the current value of the SLIDER widget.

##### Prototype

```
int SLIDER_GetValue(SLIDER_Handle hObj);
```

##### Parameters

| Parameter            | Description              |
|----------------------|--------------------------|
| <a href="#">hObj</a> | Handle of SLIDER widget. |

##### Return value

The current value of the SLIDER widget.

### 6.2.26.4.1.12 SLIDER\_Inc()

#### Description

Increments the current value of the SLIDER widget by one item.

#### Prototype

```
void SLIDER_Inc(SLIDER_Handle hObj);
```

#### Parameters

| Parameter            | Description              |
|----------------------|--------------------------|
| <a href="#">hObj</a> | Handle of SLIDER widget. |

### 6.2.26.4.1.13 SLIDER\_SetBkColor()

#### Description

Sets the background color of the SLIDER widget.

#### Prototype

```
void SLIDER_SetBkColor(SLIDER_Handle hObj,
                      GUI_COLOR      Color);
```

#### Parameters

| Parameter          | Description   |
|--------------------|---|
| <code>hObj</code>  | Handle of SLIDER widget.  |
| <code>Color</code> | <code>Color</code> to be used for the background. (range 0x000000 and 0xFFFFFFFF or a valid color define) GUI_INVALID_COLOR to make background transparent. |

#### Additional information

The background of this widget can either be filled with any available color or transparent. If a valid RGB color is specified, the background is filled with the color, otherwise the background (typically the content of the parent window) is visible. If the background is transparent, the widget is treated as transparent window, otherwise as non-transparent window. Note that using a background color allows more efficient (faster) rendering.

This widget is per default a transparent window. The appearance of a transparent windows background depends on the appearance of the parent window. When a transparent window needs to be redrawn first the background will be drawn by sending a WM\_PAINT message to the parent window.

If using this function with a valid color the status of the window will be changed from transparent to non transparent and if the window needs to be redrawn the background will be filled with the given color.

If GUI\_INVALID\_COLOR is passed to the function the status will be changed from non transparent to transparent.

#### 6.2.26.4.1.14 SLIDER\_SetDefaultFocusColor()

##### Description

Sets the default focus rectangle color for new SLIDER widgets.

##### Prototype

```
GUI_COLOR SLIDER_SetDefaultFocusColor(GUI_COLOR Color);
```

##### Parameters

| Parameter | Description                                   |
|-----------|---|
| Color     | Default color to be used for new slider bars. |

##### Return value

Previous default focus rectangle color.

##### Additional information

For more information, refer to *SLIDER\_SetFocusColor* on page 2037.



### 6.2.26.4.1.15 SLIDER\_SetFocusColor()

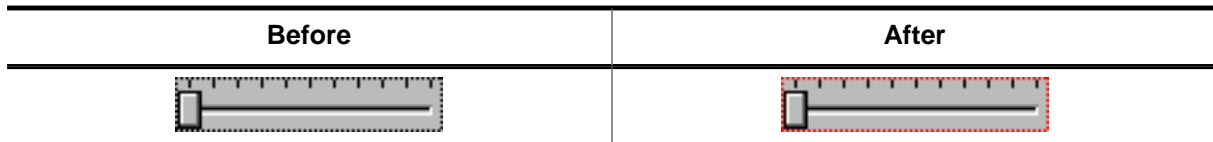

#### Description

Sets the color used to render the focus rectangle of the SLIDER widget.

#### Prototype

```
GUI_COLOR SLIDER_SetFocusColor(SLIDER_Handle hObj,
                               GUI_COLOR    Color);
```

#### Parameters

| Parameter          | Description  |
|--------------------|--|
| <code>hObj</code>  | Handle of SLIDER widget.                               |
| <code>Color</code> | <code>Color</code> to be used for the focus rectangle. |

#### Return value

Previous color of the focus rectangle.

#### Additional information

The focus rectangle is only visible if the widget has the input focus.

#### 6.2.26.4.1.16 SLIDER\_SetInvertDir()

##### Description

This function inverts the slider.

##### Prototype

```
void SLIDER_SetInvertDir(SLIDER_Handle hObj,  
                        int OnOff);
```

##### Parameters

| Parameter          | Description   |
|--------------------|---|
| <code>hObj</code>  | Handle of SLIDER widget.  |
| <code>OnOff</code> | Enables (1) or disables (0) the inversion of the slider widget. |

### 6.2.26.4.1.17 SLIDER\_SetNumTicks()

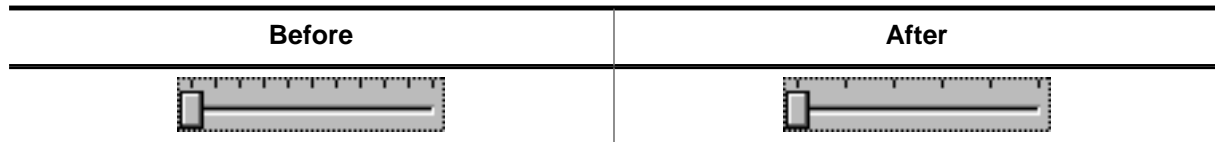

#### Description

Sets the number of tick marks of the SLIDER widget.

#### Prototype

```
void SLIDER_SetNumTicks(SLIDER_Handle hObj,
                        int NumTicks);
```

#### Parameters

| Parameter | Description                 |
|-----------|-----------------------------|
| hObj      | Handle of SLIDER widget.    |
| NumTicks  | Number of tick marks drawn. |

#### Additional information

After creating a SLIDER widget the default number of tick marks is 10. The tick marks have no effect to snap the slider bar while dragging it.

### 6.2.26.4.1.18 SLIDER\_SetRange()

#### Description

Sets the range of the SLIDER widget.

#### Prototype

```
void SLIDER_SetRange(SLIDER_Handle hObj,  
                    int           Min,  
                    int           Max);
```

#### Parameters

| Parameter         | Description              |
|-------------------|--------------------------|
| <code>hObj</code> | Handle of SLIDER widget. |
| <code>Min</code>  | Minimum value.           |
| <code>Max</code>  | Maximum value.           |

#### Additional information

After creating a SLIDER widget the default range is set to 0 - 100.

#### Examples

If a value should be modified in the range of 0 - 2499 set the range as follows:

```
SLIDER_SetRange(hSlider, 0, 2499);
```

If a value should be modified in the range of 100 - 499 set the range as follows:

```
SLIDER_SetRange(hSlider, 100, 499);
```

If a value should be modified in the range of 0 to 5000 and the slider bar should change the value in steps of 250 set the range and the tick marks as follows. The result returned by `SLIDER_GetValue()` should be multiplied with 250:

```
SLIDER_SetRange(hSlider, 0, 20);  
SLIDER_SetNumTicks(hSlider, 21);
```

#### 6.2.26.4.1.19 SLIDER\_SetUserData()

##### Description

Prototype explained at the beginning of the chapter as `<WIDGET>_SetUserData()` on page 995.

#### 6.2.26.4.1.20 SLIDER\_SetValue()

##### Description

Sets the current value of the SLIDER widget.

##### Prototype

```
void SLIDER_SetValue(SLIDER_Handle hObj,  
                    int v);
```

##### Parameters

| Parameter         | Description              |
|-------------------|--------------------------|
| <code>hObj</code> | Handle of SLIDER widget. |
| <code>v</code>    | Value to be set.         |

#### 6.2.26.4.1.21 SLIDER\_SetWidth()



### Description

Sets the width of the SLIDER widget.

### Prototype

```
void SLIDER_SetWidth(SLIDER_Handle hObj,  
                    int Width);
```

### Parameters

| Parameter          | Description                   |
|--------------------|-------------------------------|
| <code>hObj</code>  | Handle of SLIDER widget.      |
| <code>Width</code> | <code>Width</code> to be set. |

## 6.2.26.4.2 Defines

### 6.2.26.4.2.1 SLIDER create flags

#### Description

Create flags for SLIDER widgets which define the rotation of a SLIDER.

#### Definition

```
#define SLIDER_CF_HORIZONTAL    (0)
#define SLIDER_CF_VERTICAL     (1 << 3)
```

#### Symbols

| Definition                           | Description                            |
|--------------------------------------|--|
| <a href="#">SLIDER_CF_HORIZONTAL</a> | Creates a horizontal slider (default). |
| <a href="#">SLIDER_CF_VERTICAL</a>   | Creates a vertical slider.             |



## 6.2.26.5 Example

The `Sample` folder contains the following example which shows how the widget can be used:

- `DIALOG_SliderColor.c`

Note that several other examples also make use of this widget and may also be helpful to get familiar with the widget.

### Screenshot of `DIALOG_SliderColor.c`

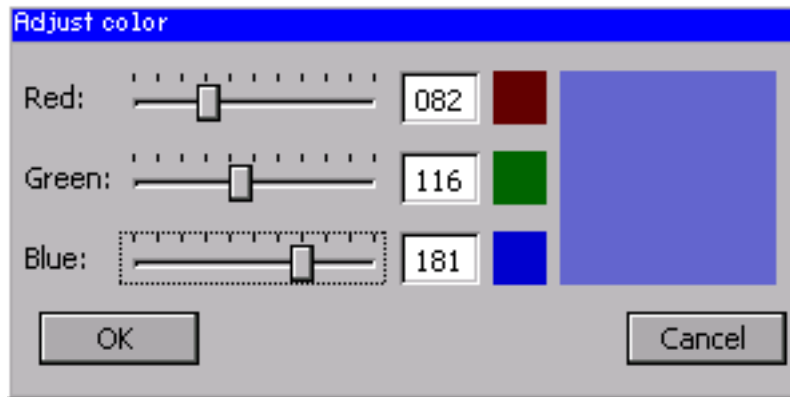

## 6.2.27 SPINBOX: Spinning box widget

SPINBOX widgets are used to manage values which need to be adjustable in a fast but still precise manner. A SPINBOX consists of 2 buttons and an embedded EDIT widget.

### Note

All SPINBOX-related routines are located in the file(s) `SPINBOX*.c` and `SPINBOX.h`. All identifiers are prefixed `SPINBOX`.

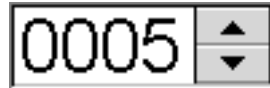

Skining...

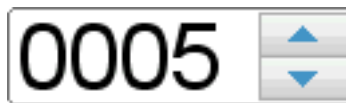

...is available for this widget. The screenshot above shows the widget using the default skin. Details can be found in the chapter *Skining* on page 2509.

### 6.2.27.1 Configuration options

| Type | Macro                           | Default       | Description                                      |
|------|---------------------------------|---------------|--|
| N    | SPINBOX_DEFAULT_BUTTON_BKCOLOR0 | 0xAAAAAA      | Background color for the button state disabled.  |
| N    | SPINBOX_DEFAULT_BUTTON_BKCOLOR1 | GUI_WHITE     | Background color for the button state pressed.   |
| N    | SPINBOX_DEFAULT_BUTTON_BKCOLOR2 | GUI_LIGHTGRAY | Background color for the button state unpressed. |
| N    | SPINBOX_DEFAULT_BUTTON_UCOLOR0  | GUI_GRAY_C8   | Background color for the button state disabled.  |
| N    | SPINBOX_DEFAULT_BUTTON_UCOLOR1  | GUI_WHITE     | Background color for the button state pressed.   |
| N    | SPINBOX_DEFAULT_BUTTON_UCOLOR2  | GUI_LIGHTGRAY | Background color for the button state unpressed. |
| N    | SPINBOX_DEFAULT_BUTTON_LCOLOR0  | 0x505050      | Background color for the button state disabled.  |
| N    | SPINBOX_DEFAULT_BUTTON_LCOLOR1  | GUI_GRAY      | Background color for the button state pressed.   |
| N    | SPINBOX_DEFAULT_BUTTON_LCOLOR2  | GUI_LIGHTGRAY | Background color for the button state unpressed. |
| N    | SPINBOX_DEFAULT_BUTTON_OCOLOR0  | 0x3F3F3F      | Background color for the button state disabled.  |
| N    | SPINBOX_DEFAULT_BUTTON_OCOLOR1  | GUI_BLACK     | Background color for the button state pressed.   |
| N    | SPINBOX_DEFAULT_BUTTON_OCOLOR2  | GUI_DARKGRAY  | Background color for the button state unpressed. |
| N    | SPINBOX_DEFAULT_BKCOLOR0        | 0xC0C0C0      | Background color for the edit state disabled.    |
| N    | SPINBOX_DEFAULT_BKCOLOR1        | GUI_WHITE     | Background color for the edit state enabled.     |

| Type | Macro                           | Default            | Description   |
|------|---------------------------------|--------------------|---|
| N    | SPINBOX_DEFAULT_TEXTCOLOR0      | 0x3F3F3F           | Background color for the edit state disabled.   |
| N    | SPINBOX_DEFAULT_TEXTCOLOR1      | GUI_BLACK          | Background color for the edit state enabled.  |
| N    | SPINBOX_DEFAULT_TRIANGLE_COLOR0 | GUI_GRAY_3F        | Background color for the button state disabled.   |
| N    | SPINBOX_DEFAULT_TRIANGLE_COLOR1 | GUI_BLACK          | Background color for the button state pressed.  |
| N    | SPINBOX_DEFAULT_TRIANGLE_COLOR2 | GUI_DARKGRAY       | Background color for the button state unpressed.  |
| N    | SPINBOX_DEFAULT_MIN             | 0                  | Minimum value.  |
| N    | SPINBOX_DEFAULT_MAX             | 100                | Maximum value.  |
| N    | SPINBOX_DEFAULT_STEP            | 1                  | Value will be increased/decreased by this amount when a button is clicked.  |
| N    | SPINBOX_DEFAULT_BUTTON_SIZE     | 0                  | X-Size of the buttons.  |
| N    | SPINBOX_DEFAULT_EDGE            | SPINBOX_EDGE_RIGHT | Determines the position of the buttons. See table below.  |
| N    | SPINBOX_TIMER_PERIOD_START      | 400                | Once a button is pressed for this amount of time, a timer is created to increase/decrease the value continuously. |
| N    | SPINBOX_TIMER_PERIOD            | 50                 | Once the timer is created values are adjusted at intervals of this amount of time.                                |

| Possible values to be defined as SPINBOX_DEFAULT_EDGE |  |
|---|--|
| SPINBOX_EDGE_LEFT                                     | Buttons are displayed on the left edge of the widget.  |
| SPINBOX_EDGE_RIGHT                                    | Buttons are displayed on the right edge of the widget. |

### 6.2.27.2 Predefined IDs

The following symbols define IDs which may be used to make SPINBOX widgets distinguishable from creation.

```
#define GUI_ID_SPINBOX0    0x280
#define GUI_ID_SPINBOX1    0x281
#define GUI_ID_SPINBOX2    0x282
#define GUI_ID_SPINBOX3    0x283
#define GUI_ID_SPINBOX4    0x284
#define GUI_ID_SPINBOX5    0x285
#define GUI_ID_SPINBOX6    0x286
#define GUI_ID_SPINBOX7    0x287
#define GUI_ID_SPINBOX8    0x288
#define GUI_ID_SPINBOX9    0x289
```

### 6.2.27.3 Notification codes

The following events are sent from the spinbox widget to its parent window as part of a WM\_NOTIFY\_PARENT message:

| Message                   | Description                                    |
|---------------------------|--|
| WM_NOTIFICATION_CLICKED   | Button has been clicked.                       |
| WM_NOTIFICATION_RELEASED  | Button has been released.                      |
| WM_NOTIFICATION_MOVED_OUT | Pointer has been moved out of the widget area. |

| Message                       | Description                                  |
|-------------------------------|--|
| WM_NOTIFICATION_VALUE_CHANGED | The value of the SPINBOX widget has changed. |

### 6.2.27.4 Keyboard reaction

The widget is able to receive the input focus. All key events are forwarded to the embedded edit widget. Detailed information can be taken from the EDIT widget section.

### 6.2.27.5 SPINBOX API

The table below lists the available emWin SPINBOX-related routines in alphabetical order. Detailed descriptions of the routines follow.

#### Functions

| Routine                                     | Description   |
|---|---|
| <code>SPINBOX_CreateEx()</code>             | Creates a SPINBOX widget.   |
| <code>SPINBOX_CreateIndirect()</code>       | Creates a SPINBOX widget. (Obsolete)  |
| <code>SPINBOX_CreateUser()</code>           | Creates a SPINBOX widget using extra bytes as user data.  |
| <code>SPINBOX_EnableBlink()</code>          | Enables/disables blinking of the cursor.  |
| <code>SPINBOX_GetBkColor()</code>           | Returns the background color of the SPINBOX widget.   |
| <code>SPINBOX_GetButtonBkColor()</code>     | Returns the background color of the buttons.  |
| <code>SPINBOX_GetDefaultButtonSize()</code> | Returns the default x-size of the buttons.  |
| <code>SPINBOX_GetEditHandle()</code>        | Returns the handle to the attached EDIT widget.   |
| <code>SPINBOX_GetFont()</code>              | Returns the font of the SPINBOX widget.   |
| <code>SPINBOX_GetRange()</code>             | Gets the minimum and maximum value set for the SPINBOX.   |
| <code>SPINBOX_GetTextColor()</code>         | Returns the text color.   |
| <code>SPINBOX_GetUserData()</code>          | Retrieves the data which was previously set with <code>SPINBOX_SetUserData()</code> .           |
| <code>SPINBOX_GetValue()</code>             | Returns the value of the SPINBOX widget.  |
| <code>SPINBOX_SetBkColor()</code>           | Sets the background color of the SPINBOX widget.  |
| <code>SPINBOX_SetButtonBkColor()</code>     | Sets the background color of the buttons.   |
| <code>SPINBOX_SetButtonSize()</code>        | Sets the button size of the given SPINBOX widget.   |
| <code>SPINBOX_SetDefaultButtonSize()</code> | Sets the default x-size of the buttons.   |
| <code>SPINBOX_SetEdge()</code>              | Sets the edge to display the buttons on.  |
| <code>SPINBOX_SetEditMode()</code>          | Sets the spinbox widget to either edit or step mode.  |
| <code>SPINBOX_SetFont()</code>              | Sets the font used to display the value.  |
| <code>SPINBOX_SetRange()</code>             | Sets the minimum and maximum value.   |
| <code>SPINBOX_SetStep()</code>              | Sets the value to be used for incrementing and decrementing in 'Step' mode.                     |
| <code>SPINBOX_SetTextColor()</code>         | Sets the color of the displayed value.  |
| <code>SPINBOX_SetTimerPeriod()</code>       | This function sets the time it takes before the SPINBOX widget starts increasing or decreasing. |

| Routine                            | Description   |
|------------------------------------|---|
|                                    | ing its value automatically when a button keeps beeing pressed.                                   |
| <code>SPINBOX_SetUserData()</code> | Stores user data using the extra bytes which were reserved by <code>SPINBOX_CreateUser()</code> . |
| <code>SPINBOX_SetValue()</code>    | Sets the value of the SPINBOX.  |

## Defines

| Group of defines                     | Description   |
|--------------------------------------|---|
| <code>SPINBOX color indexes</code>   | Color indexes used by SPINBOX widgets.                        |
| <code>SPINBOX edge flags</code>      | Flags used by <code>SPINBOX_SetEdge()</code> .                |
| <code>SPINBOX edit mode flags</code> | Flags used by <code>SPINBOX_SetEditMode()</code> .            |
| <code>SPINBOX timer indexes</code>   | Timer indexes used by <code>SPINBOX_SetTimerPeriod()</code> . |

## 6.2.27.5.1 Functions

### 6.2.27.5.1.1 SPINBOX\_CreateEx()

#### Description

Creates a SPINBOX widget.

#### Prototype

```
SPINBOX_Handle SPINBOX_CreateEx(int    x0,
                                int    y0,
                                int    xSize,
                                int    ySize,
                                WM_HWIN hParent,
                                int    WinFlags,
                                int    Id,
                                int    Min,
                                int    Max);
```

#### Parameters

| Parameter             | Description   |
|-----------------------|---|
| <code>x0</code>       | Leftmost pixel of the widget (in parent coordinates).   |
| <code>y0</code>       | Topmost pixel of the widget (in parent coordinates).  |
| <code>xSize</code>    | Horizontal size of the widget (in pixels).  |
| <code>ySize</code>    | Vertical size of the widget (in pixels).  |
| <code>hParent</code>  | Handle of the parent window. If 0, the widget will be created as a child of the top-level window (desktop).   |
| <code>WinFlags</code> | Window create flags. In order to make the widget visible immediately <code>WM_CF_SHOW</code> should be used. The complete list of available parameters can be found under <i>Window create flags</i> on page 977. |
| <code>Id</code>       | Window ID to be set for the widget.   |
| <code>Min</code>      | Minimum permitted value.  |
| <code>Max</code>      | Maximum permitted value.  |

#### Return value

Handle of the created SPINBOX widget. If an error occurred during creation, 0 is returned.

### 6.2.27.5.1.2 SPINBOX\_CreateIndirect()

#### Description

The prototype of this function is explained at the beginning of this chapter. Details can be found in the description of the function `<WIDGET>_CreateIndirect()` on page 992. The element `Flags` of the according `GUI_WIDGET_CREATE_INFO` structure is not used. The upper 16 bit of the element `Para` are used according to the parameter `Max` of the function `SPINBOX_CreateEx()`. The lower 16 bit of the element `Para` are used according to the parameter `Min` of the function `SPINBOX_CreateEx()`.

### 6.2.27.5.1.3 SPINBOX\_CreateUser()

#### Description

Prototype explained at the beginning of the chapter as `<WIDGET>_CreateUser()` on page 993. For a detailed description of the parameters the function `SPINBOX_CreateEx()` can be referred to.



#### 6.2.27.5.1.4 SPINBOX\_EnableBlink()

##### Description

Enables/disables blinking of the cursor.

##### Prototype

```
void SPINBOX_EnableBlink(SPINBOX_Handle hObj,  
                        int             Period,  
                        int             OnOff);
```

##### Parameters

| Parameter              | Description  |
|------------------------|--|
| <a href="#">hObj</a>   | Handle of the SPINBOX widget.                                    |
| <a href="#">Period</a> | <a href="#">Period</a> in which the cursor is turned off and on. |
| <a href="#">OnOff</a>  | 1 enables blinking, 0 disables blinking.                         |

### 6.2.27.5.1.5 SPINBOX\_GetBkColor()

#### Description

Returns the background color of the SPINBOX widget.

#### Prototype

```
GUI_COLOR SPINBOX_GetBkColor(SPINBOX_Handle hObj,  
                             unsigned int  Index);
```

#### Parameters

| Parameter             | Description  |
|-----------------------|--|
| <a href="#">hObj</a>  | Handle of the SPINBOX widget.  |
| <a href="#">Index</a> | See <i>SPINBOX color indexes</i> on page 2076 for a full list of permitted values. |

#### Return value

Background color of the SPINBOX widget.

### 6.2.27.5.1.6 SPINBOX\_GetButtonBkColor()

#### Description

Returns the background color of the buttons.

#### Prototype

```
GUI_COLOR SPINBOX_GetButtonBkColor(SPINBOX_Handle hObj,  
                                   unsigned int   Index);
```

#### Parameters

| Parameter             | Description  |
|-----------------------|--|
| <a href="#">hObj</a>  | Handle of the SPINBOX widget.  |
| <a href="#">Index</a> | See <i>SPINBOX color indexes</i> on page 2076 for a full list of permitted values. |

#### Return value

Background color of the buttons.

### 6.2.27.5.1.7 SPINBOX\_GetDefaultButtonSize()

#### Description

Returns the default x-size of the buttons.

#### Prototype

```
U16 SPINBOX_GetDefaultButtonSize(void);
```

#### Return value

Default x-size of the buttons.

### 6.2.27.5.1.8 SPINBOX\_GetEditHandle()

#### Description

Returns the handle to the attached EDIT widget.

#### Prototype

```
EDIT_Handle SPINBOX_GetEditHandle(SPINBOX_Handle hObj);
```

#### Parameters

| Parameter            | Description                   |
|----------------------|-------------------------------|
| <a href="#">hObj</a> | Handle of the SPINBOX widget. |

#### Return value

Handle of the attached EDIT widget.

### 6.2.27.5.1.9 SPINBOX\_GetFont()

#### Description

Returns the font of the SPINBOX widget.

#### Prototype

```
GUI_FONT *SPINBOX_GetFont(SPINBOX_Handle hObj);
```

#### Parameters

| Parameter            | Description                   |
|----------------------|-------------------------------|
| <a href="#">hObj</a> | Handle of the SPINBOX widget. |

#### Return value

A pointer to the font of the SPINBOX widget.

### 6.2.27.5.1.10 SPINBOX\_GetRange()

#### Description

Gets the minimum and maximum value set for the SPINBOX.

#### Prototype

```
void SPINBOX_GetRange(SPINBOX_Handle  hObj,  
                     I32             * pMin,  
                     I32             * pMax);
```

#### Parameters

| Parameter         | Description                   |
|-------------------|-------------------------------|
| <code>hObj</code> | Handle to the SPINBOX widget. |
| <code>pMin</code> | Minimum value.                |
| <code>pMax</code> | Maximum value.                |

### 6.2.27.5.1.11 SPINBOX\_GetTextColor()

#### Description

Returns the color of the displayed value.

#### Prototype

```
GUI_COLOR SPINBOX_GetTextColor(SPINBOX_Handle hObj,  
                               unsigned int   Index);
```

#### Parameters

| Parameter             | Description  |
|-----------------------|--|
| <a href="#">hObj</a>  | Handle of the SPINBOX widget.  |
| <a href="#">Index</a> | See <i>SPINBOX color indexes</i> on page 2076 for a full list of permitted values. |

#### Return value

The color of the value to be displayed.



### 6.2.27.5.1.12 SPINBOX\_GetUserData()

#### Description

Prototype explained at the beginning of the chapter as `<WIDGET>_GetUserData()` on page 994.

### 6.2.27.5.1.13 SPINBOX\_GetValue()

#### Description

Returns the value of the SPINBOX widget.

#### Prototype

```
I32 SPINBOX_GetValue(SPINBOX_Handle hObj);
```

#### Parameters

| Parameter            | Description                   |
|----------------------|-------------------------------|
| <a href="#">hObj</a> | Handle of the SPINBOX widget. |

#### Return value

Value of the SPINBOX widget.

### 6.2.27.5.1.14 SPINBOX\_SetBkColor()

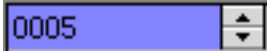
| Before  | After  |
|---|--|
|  |  |

#### Description

Sets the background color of the SPINBOX widget.



#### Prototype

```
void SPINBOX_SetBkColor(SPINBOX_Handle hObj,
                       unsigned int   Index,
                       GUI_COLOR      Color);
```

#### Parameters

| Parameter          | Description  |
|--------------------|--|
| <code>hObj</code>  | Handle of the SPINBOX widget.  |
| <code>Index</code> | See <i>SPINBOX color indexes</i> on page 2076 for a full list of permitted values. |
| <code>Color</code> | <code>Color</code> to be used for the background.                                  |

### 6.2.27.5.1.15 SPINBOX\_SetButtonBkColor()

| Before  | After  |
|---|--|
|  |  |

#### Description

Sets the background color of the buttons.

#### Prototype

```
void SPINBOX_SetButtonBkColor(SPINBOX_Handle hObj,
                             unsigned int   Index,
                             GUI_COLOR      Color);
```

#### Parameters

| Parameter             | Description  |
|-----------------------|--|
| <a href="#">hObj</a>  | Handle of the SPINBOX widget.  |
| <a href="#">Index</a> | See <i>SPINBOX color indexes</i> on page 2076 for a full list of permitted values. |
| <a href="#">Color</a> | <a href="#">Color</a> to be used for the background.                               |

### 6.2.27.5.1.16 SPINBOX\_SetButtonSize()



#### Description

Sets the button size of the given SPINBOX widget.

#### Prototype

```
void SPINBOX_SetButtonSize(SPINBOX_Handle hObj,  
                           unsigned      ButtonSize);
```

#### Parameters

| Parameter               | Description                       |
|-------------------------|-----------------------------------|
| <code>hObj</code>       | Handle of the SPINBOX widget.     |
| <code>ButtonSize</code> | Button size in pixels to be used. |

### 6.2.27.5.1.17 SPINBOX\_SetDefaultButtonSize()



#### Description

Sets the default *x*-size of the buttons.

#### Prototype

```
void SPINBOX_SetDefaultButtonSize(U16 ButtonSize);
```

#### Parameters

| Parameter | Description                                |
|-----------|--|
| <i>x</i>  | New default <i>x</i> -size of the buttons. |

#### Additional information

If the default button size is set to 0, the size of the button is determined automatically on creation.

### 6.2.27.5.1.18 SPINBOX\_SetEdge()

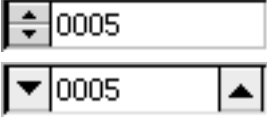
| Before  | After  |
|---|--|
|  |  |

#### Description

Sets the edge to display the buttons on.

#### Prototype

```
void SPINBOX_SetEdge(SPINBOX_Handle hObj,
                    U8 Edge);
```

#### Parameters

| Parameter            | Description   |
|----------------------|---|
| <a href="#">hObj</a> | Handle of the SPINBOX widget.   |
| <a href="#">Edge</a> | See <i>SPINBOX edge flags</i> on page 2077 for a full list of permitted values. |

### 6.2.27.5.1.19 SPINBOX\_SetEditMode()

#### Description

Sets the spinbox widget to either edit or step mode.

#### Prototype

```
void SPINBOX_SetEditMode(SPINBOX_Handle hObj,  
                        U8 EditMode);
```

#### Parameters

| Parameter                | Description                                      |
|--------------------------|--|
| <a href="#">hObj</a>     | Handle of the SPINBOX widget.                    |
| <a href="#">EditMode</a> | See <i>SPINBOX edit mode flags</i> on page 2078. |

#### Additional information

The widget supports the 'Step' mode (default) and the 'Edit' mode. 'Step' mode means each time one of the buttons is pressed the value of the box is incremented or decremented by the step value. 'Edit' mode means each single digit can be modified separately. If 'Edit' mode is selected the EDIT field becomes editable and a cursor appears. When pressing a button the focused digit will be incremented or decremented by 1. In 'Edit' mode the EDIT field also accepts digits as keyboard input.



### 6.2.27.5.1.20 SPINBOX\_SetFont()

| Before  | After  |
|---|--|
|  |  |

#### Description

Sets the font used to display the value.

#### Prototype

```
void SPINBOX_SetFont(      SPINBOX_Handle  hObj,
                          const GUI_FONT  * pFont);
```

#### Parameters

| Parameter          | Description                     |
|--------------------|---------------------------------|
| <code>hObj</code>  | Handle to the SPINBOX widget.   |
| <code>pFont</code> | Pointer to the font to be used. |

### 6.2.27.5.1.21 SPINBOX\_SetRange()

#### Description

Sets the minimum and maximum value.

#### Prototype

```
void SPINBOX_SetRange(SPINBOX_Handle hObj,  
                     I32             Min,  
                     I32             Max);
```

#### Parameters

| Parameter            | Description                   |
|----------------------|-------------------------------|
| <a href="#">hObj</a> | Handle to the SPINBOX widget. |
| <a href="#">Min</a>  | Minimum value.                |
| <a href="#">Max</a>  | Maximum value.                |

### 6.2.27.5.1.22 SPINBOX\_SetStep()

#### Description

Sets the value to be used for incrementing and decrementing in 'Step' mode.

#### Prototype

```
U16 SPINBOX_SetStep(SPINBOX_Handle hObj,  
                   U16           Step);
```

#### Parameters

| Parameter            | Description                   |
|----------------------|-------------------------------|
| <a href="#">hObj</a> | Handle to the SPINBOX widget. |
| <a href="#">Step</a> | Value to be used.             |

#### Return value

Previous used step value.

### 6.2.27.5.1.23 SPINBOX\_SetTextColor()

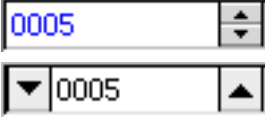
| Before  | After  |
|---|--|
|  |  |

#### Description

Sets the color of the displayed value.

#### Prototype

```
void SPINBOX_SetTextColor(SPINBOX_Handle hObj,
                          unsigned int   Index,
                          GUI_COLOR      Color);
```

#### Parameters

| Parameter             | Description  |
|-----------------------|--|
| <a href="#">hObj</a>  | Handle of the SPINBOX widget.  |
| <a href="#">Index</a> | See <i>SPINBOX color indexes</i> on page 2076 for a full list of permitted values. |
| <a href="#">Color</a> | <a href="#">Color</a> to be set for the text.                                      |

### 6.2.27.5.1.24 SPINBOX\_SetTimerPeriod()

#### Description

This function sets the time it takes before the SPINBOX widget starts increasing or decreasing its value automatically when a button keeps being pressed.

#### Prototype

```
void SPINBOX_SetTimerPeriod(SPINBOX_Handle hObj,  
                             U32          Index,  
                             U32          Period);
```

#### Parameters

| Parameter              | Description   |
|------------------------|---|
| <a href="#">hObj</a>   | Handle of the SPINBOX widget.                               |
| <a href="#">Index</a>  | Timer index. See <i>SPINBOX timer indexes</i> on page 2079. |
| <a href="#">Period</a> | Color to be set for the text.                               |

### 6.2.27.5.1.25 SPINBOX\_SetUserData()

#### Description

Prototype explained at the beginning of the chapter as `<WIDGET>_SetUserData()` on page 995.

### 6.2.27.5.1.26 SPINBOX\_SetValue()

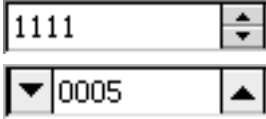
| Before  | After  |
|---|--|
|  |  |

#### Description

Sets the value of the SPINBOX.

#### Prototype

```
void SPINBOX_SetValue(SPINBOX_Handle hObj,
                     I32 Value);
```

#### Parameters

| Parameter         | Description                   |
|-------------------|-------------------------------|
| <code>hObj</code> | Handle of the SPINBOX widget. |
| <code>v</code>    | Value to be set.              |

## 6.2.27.5.2 Defines

### 6.2.27.5.2.1 SPINBOX color indexes

#### Description

Color indexes used for SPINBOX widgets.

#### Definition

```
#define SPINBOX_CI_DISABLED    0
#define SPINBOX_CI_ENABLED    1
#define SPINBOX_CI_PRESSED    2
```

#### Symbols

| Definition                          | Description                                 |
|-------------------------------------|---|
| <a href="#">SPINBOX_CI_DISABLED</a> | Color for disabled state.                   |
| <a href="#">SPINBOX_CI_ENABLED</a>  | Color for enabled state.                    |
| <a href="#">SPINBOX_CI_PRESSED</a>  | Color for pressed state (only for buttons). |



### 6.2.27.5.2 SPINBOX edge flags

#### Description

Flags used by the routine `SPINBOX_SetEdge()` to define the button placement of a SPINBOX widget.

#### Definition

```
#define SPINBOX_EDGE_RIGHT    0
#define SPINBOX_EDGE_LEFT    1
#define SPINBOX_EDGE_CENTER  2
```

#### Symbols

| Definition                       | Description  |
|----------------------------------|--|
| <code>SPINBOX_EDGE_RIGHT</code>  | Buttons are displayed on the right edge of the widget.           |
| <code>SPINBOX_EDGE_LEFT</code>   | Buttons are displayed on the left edge of the widget.            |
| <code>SPINBOX_EDGE_CENTER</code> | Buttons are displayed on the left and right edges of the widget. |

### 6.2.27.5.2.3 SPINBOX edit mode flags

#### Description

Flags used for activating edit mode for a SPINBOX widget. For more information, refer to `SPINBOX_SetEditMode()`.

#### Definition

```
#define SPINBOX_EM_STEP    0
#define SPINBOX_EM_EDIT   1
```

#### Symbols

| Definition                      | Description   |
|---------------------------------|---|
| <a href="#">SPINBOX_EM_STEP</a> | Pressing a button adds or subtracts the step value. |
| <a href="#">SPINBOX_EM_EDIT</a> | Pressing a button increments or decrements a digit. |

#### 6.2.27.5.2.4 SPINBOX timer indexes

##### Description

Timer indexes used by the routine `SPINBOX_SetTimerPeriod()`.

##### Definition

```
#define SPINBOX_TI_TIMERSTART    0
#define SPINBOX_TI_TIMERINC     1
```

##### Symbols

| Definition                            | Description   |
|---------------------------------------|---|
| <a href="#">SPINBOX_TI_TIMERSTART</a> | Time it takes to start auto increase/decrease of its value. |
| <a href="#">SPINBOX_TI_TIMERINC</a>   | Time between two increments/decrements.                     |

## 6.2.27.6 Example

The `Sample` folder contains the following example which shows how the widget can be used:

- `WIDGET_Spinbox.c`

### Screenshot of `WIDGET_Spinbox.c`

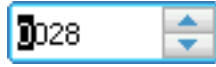

## 6.2.28 SWIPELIST: Swipelist widget

A SWIPELIST widget enables smooth scrolling of a list by swiping over the touchscreen or any other pointer input device (PID). Each SWIPELIST item can show several lines of text and/or a bitmap. It is also possible to assign one or more windows/widgets to each item. When swiping over the touchscreen the list follows the PID. After releasing the PID the list is decelerated smoothly until it stops. The interface of the SWIPELIST allows per default reacting on click-, release- and selection change events.

### Note

All SWIPELIST-related routines are located in the file(s) SWIPELIST\* .c, SWIPELIST .h. All identifiers are prefixed SWIPELIST.

### 6.2.28.1 Structure of the SWIPELIST widget

The following diagram shows the detailed structure and look of an item of the SWIPELIST widget:

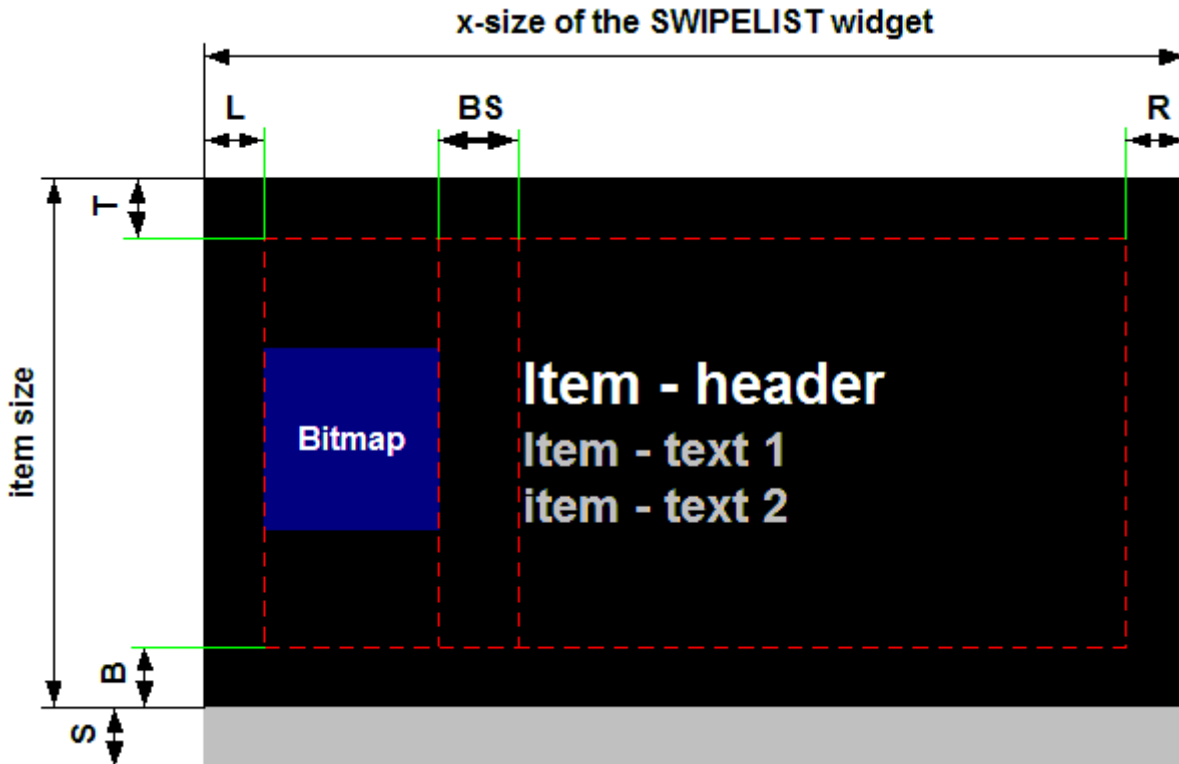

Information about the different diagram indices can be found in the table below.

| Details | Description   |
|---------|---|
| B       | Bottom border used for all items. (Default: 5 pixels)                               |
| BS      | Size between bitmap and text (bitmap space) used for all items. (Default: 5 pixels) |
| L       | Left border used for all items. (Default: 5 pixels)                                 |
| R       | Right border used for all items. (Default: 5 pixels)                                |
| S       | Separator line can be set individual for all items. (Default: 1 pixel)              |
| T       | Top border used for all items. (Default: 5 pixels)                                  |

The following diagram shows the structure and look of a SWIPELIST widget:

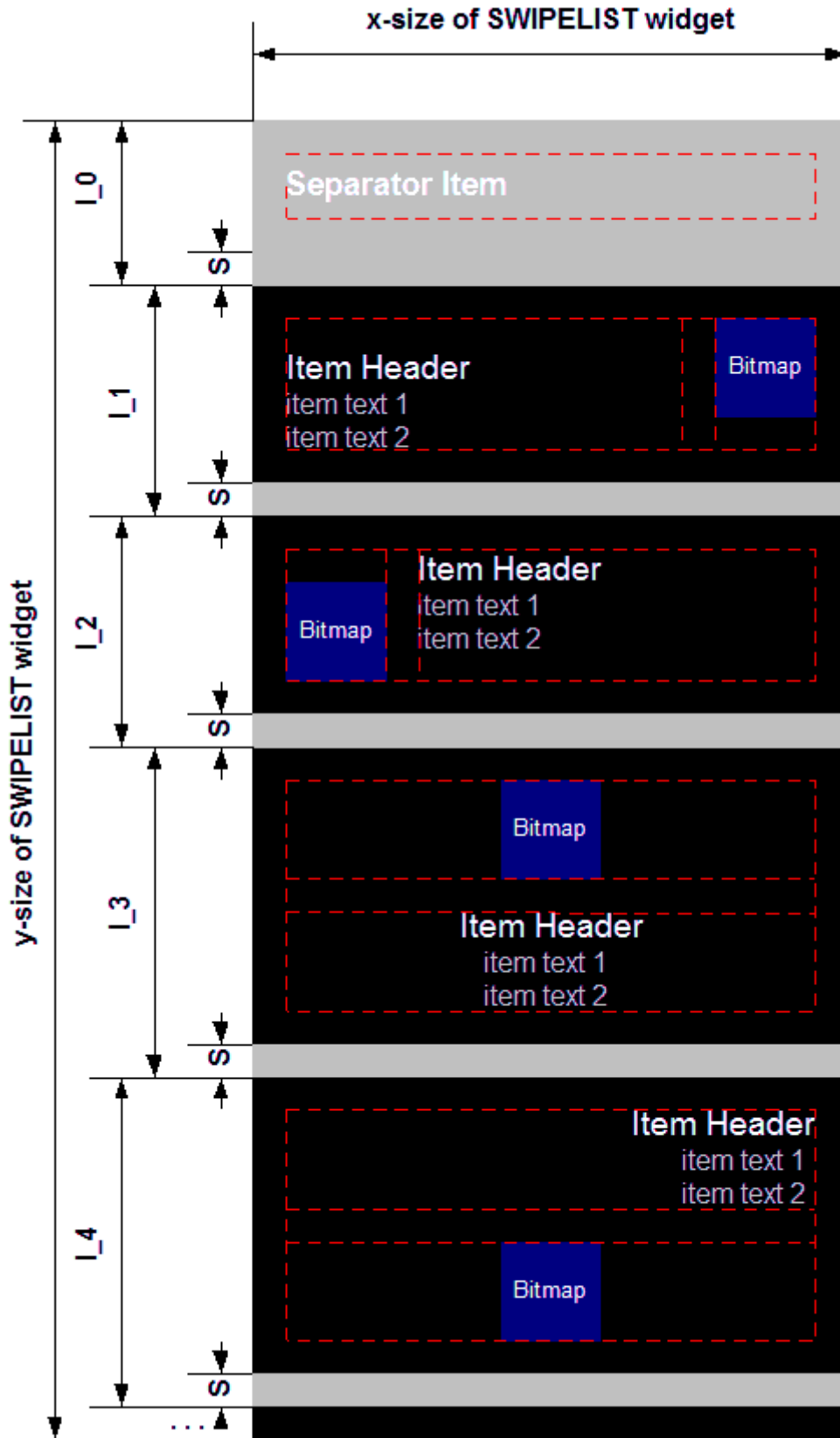

SWIPELIST widgets consists of items. Separator items are items with different properties.

| Details | Description  |
|---------|--|
| $I_0$   | Separator item of SWIPELIST widget. (ItemIndex = 0)<br>+ text (alignment: vertical center, left) |

| Details | Description   |
|---------|---|
| I_1     | Item of SWIPELIST widget. (ItemIndex = 1)<br>+ bitmap (alignment: top, right)<br>+ text (alignment: bottom, left)                       |
| I_2     | Item of SWIPELIST widget. (ItemIndex = 2)<br>+ bitmap (alignment: bottom, left)<br>+ text (alignment: Top, left)                        |
| I_3     | Item of SWIPELIST widget. (ItemIndex = 3)<br>+ bitmap (alignment: top, horizontal center)<br>+ Text (alignment: top, horizontal center) |
| I_4     | Item of SWIPELIST widget. (ItemIndex = 4)<br>+ bitmap (alignment: bottom, horizontal center)<br>+ text (alignment: bottom, right)       |
| S       | Separator line can be set individual for all items. (Default: 1 pixel)  |

### 6.2.28.2 Difference between separator items and items

Separator items are useful to group items by different topics. They will be drawn (by default) with different fonts and colors.

All API-functions can be used for separator items, too.

|                           | Item  | Separator item                |
|---------------------------|---|-------------------------------|
| <b>Fonts</b>              | One font for the header text.<br>One font for the text.                               | One font for all texts.       |
| <b>Font colors</b>        | Two colors for the header text (SEL & UNSEL)<br>Two colors for the text (SEL & UNSEL) | One color for all texts.      |
| <b>Background color</b>   | Two colors for background (SEL & UNSEL)   | One color for the background. |
| <b>Selection</b>          | One item can be selected at same time.<br>This item change the look (SEL-colors)      | Can not be selected.          |
| <b>Notification codes</b> | WM_NOTIFICATION_CLICKED<br>WM_NOTIFICATION_RELEASED<br>WM_NOTIFICATION_SEL_CHANGED    | None.                         |

### 6.2.28.3 Configuration options

| Type | Macro                                 | Default   | Description                            |
|------|---------------------------------------|-----------|--|
| N    | SWIPELIST_DEFAULT_BITMAP_SPACE        | 5         | Space between text and bitmap.         |
| N    | SWIPELIST_DEFAULT_BORDERSIZE_B        | 5         | Border of bottom for items.            |
| N    | SWIPELIST_DEFAULT_BORDERSIZE_L        | 5         | Border of left side for items.         |
| N    | SWIPELIST_DEFAULT_BORDERSIZE_R        | 5         | Border of right side for items.        |
| N    | SWIPELIST_DEFAULT_BORDERSIZE_T        | 5         | Border of top for items.               |
| N    | SWIPELIST_DEFAULT_ITEM_BK_COLOR_UNSEL | GUI_BLACK | Background color for unselected items. |
| N    | SWIPELIST_DEFAULT_ITEM_BK_COLOR_SEL   | GUI_BLUE  | Background color for selected item.    |

| Type | Macro                                     | Default                         | Description   |
|------|---|---------------------------------|---|
| N    | SWIPELIST_DEFAULT_ITEM_HEADER_COLOR_UNSEL | GUI_WHITE                       | Header text color for unselected items.                                     |
| N    | SWIPELIST_DEFAULT_ITEM_HEADER_COLOR_SEL   | GUI_WHITE                       | Header text color for selected item.  |
| S    | SWIPELIST_DEFAULT_ITEM_HEADER_FONT        | &GUI_Font16_1                   | Font for item header text.  |
| N    | SWIPELIST_DEFAULT_ITEM_SEP_COLOR          | GUI_GRAY                        | Color of the separator line for items.                                      |
| N    | SWIPELIST_DEFAULT_ITEM_SEP_SIZE           | 1                               | Size of the separator line for items.                                       |
| N    | SWIPELIST_DEFAULT_ITEM_TEXT_COLOR_UNSEL   | GUI_GRAY                        | Text color for unselected items.  |
| N    | SWIPELIST_DEFAULT_ITEM_TEXT_COLOR_SEL     | GUI_GRAY                        | Text color for selected item.   |
| S    | SWIPELIST_DEFAULT_ITEM_TEXT_FONT          | &GUI_Font13_1                   | Font for item text.   |
| N    | SWIPELIST_DEFAULT_MIN_MOVE                | 5                               | Minimum pixels to start a moving operation.                                 |
| N    | SWIPELIST_DEFAULT_OVERLAP                 | 0                               | Overlapping distance.   |
| N    | SWIPELIST_DEFAULT_PERIOD_OVERLAP          | 200                             | Period for automatic moving back when overlap area is entered and released. |
| N    | SWIPELIST_DEFAULT_SEP_ITEM_BK_COLOR       | GUI_GRAY                        | Background color for separator item.  |
| S    | SWIPELIST_DEFAULT_SEP_ITEM_FONT           | &GUI_Font20_1                   | Font for separator item.  |
| N    | SWIPELIST_DEFAULT_SEP_ITEM_TEXT_COLOR     | GUI_WHITE                       | Text color for separator item.  |
| N    | SWIPELIST_DEFAULT_TEXT_ALIGN              | GUI_TA_LEFT  <br>GUI_TA_VCENTER | Text alignment for separator items and items.                               |

### 6.2.28.4 Predefined IDs

The following symbols define IDs which may be used to make SWIPELIST widgets distinguishable from creation.

```
#define GUI_ID_SWIPELIST0    0x320
#define GUI_ID_SWIPELIST1    0x321
#define GUI_ID_SWIPELIST2    0x322
#define GUI_ID_SWIPELIST3    0x323
#define GUI_ID_SWIPELIST4    0x324
#define GUI_ID_SWIPELIST5    0x325
#define GUI_ID_SWIPELIST6    0x326
#define GUI_ID_SWIPELIST7    0x327
#define GUI_ID_SWIPELIST8    0x328
#define GUI_ID_SWIPELIST9    0x329
```



## 6.2.28.5 Notification codes

The following events are sent from a SWIPELIST widget to its parent window as part of a WM\_NOTIFY\_PARENT message:

| Message                                       | Description  |
|---|--|
| SWIPELIST_NOTIFICATION_OVERLAP_TOP_ENTERED    | Sent when the overlap area was entered at the top of the SWIPELIST.                            |
| SWIPELIST_NOTIFICATION_OVERLAP_BOTTOM_ENTERED | Sent when the overlap area was entered at the bottom of the SWIPELIST.                         |
| SWIPELIST_NOTIFICATION_OVERLAP_RELEASED       | Sent after a dragged overlap area has been released.   |
| WM_NOTIFICATION_CLICKED                       | Item of SWIPELIST widget has been clicked.   |
| WM_NOTIFICATION_RELEASED                      | Item of SWIPELIST widget has been released.  |
| WM_NOTIFICATION_SEL_CHANGED                   | Item of SWIPELIST widget has been clicked and the pointer has been moved out of the item area. |

## 6.2.28.6 SWIPELIST API

The table below lists the available emWin SWIPELIST-related routines in alphabetical order. Detailed descriptions of the routines follow.

### Functions

| Routine                           | Description  |
|-----------------------------------|--|
| SWIPELIST_AddItem()               | Adds a new item.   |
| SWIPELIST_AddItemText()           | Adds a text to the item.                                   |
| SWIPELIST_AddSepItem()            | Adds a new separator item.                                 |
| SWIPELIST_CreateEx()              | Creates a SWIPELIST widget.                                |
| SWIPELIST_CreateIndirect()        | Creates a SWIPELIST widget from a resource table entry.    |
| SWIPELIST_CreateUser()            | Creates a SWIPELIST widget using extra bytes as user data. |
| SWIPELIST_DeleteItem()            | Deletes an item from the SWIPELIST widget.                 |
| SWIPELIST_GetBitmap()             | Returns a pointer to the optional bitmap of the item.      |
| SWIPELIST_GetBitmapSpace()        | Returns the space between text and bitmap.                 |
| SWIPELIST_GetBkColor()            | Returns the background color.                              |
| SWIPELIST_GetBorderSize()         | Returns the size of the border.                            |
| SWIPELIST_GetDefaultBitmapSpace() | Returns the default space between text and bitmap.         |
| SWIPELIST_GetDefaultBkColor()     | Returns the default background color.                      |
| SWIPELIST_GetDefaultBorderSize()  | Returns the default border size.                           |
| SWIPELIST_GetDefaultFont()        | Returns a pointer to the default font.                     |
| SWIPELIST_GetDefaultOverlap()     | Returns the default overlap value used for new widgets.    |
| SWIPELIST_GetDefaultSepColor()    | Returns the default color of the separator line.           |

| Routine  | Description   |
|--|---|
| <code>SWIPELIST_GetDefaultSepSize()</code>     | Returns the default size of the separator line.   |
| <code>SWIPELIST_GetDefaultTextColor()</code>   | Returns the default color of the text.  |
| <code>SWIPELIST_GetDefaultTextAlign()</code>   | Returns the default alignment of the text.  |
| <code>SWIPELIST_GetDefaultThreshold()</code>   | Returns the default threshold value.  |
| <code>SWIPELIST_GetFont()</code>               | Returns a pointer to the font.  |
| <code>SWIPELIST_GetItemSize()</code>           | Returns the size (in pixels) of the given item.   |
| <code>SWIPELIST_GetItemUserData()</code>       | Retrieves the previously stored user data from a given item.  |
| <code>SWIPELIST_GetNumItems()</code>           | Returns the number of items.  |
| <code>SWIPELIST_GetNumText()</code>            | Returns the number of texts in a item.  |
| <code>SWIPELIST_GetOverlap()</code>            | Returns the overlap parameters of the given SWIPELIST widget.   |
| <code>SWIPELIST_GetReleasedItem()</code>       | Returns the item index of the last released item.   |
| <code>SWIPELIST_GetScrollPos()</code>          | Returns the scroll position of the widget.  |
| <code>SWIPELIST_GetSelItem()</code>            | Returns the current selected item index of the given SWIPELIST widget. Returns the current selected item. |
| <code>SWIPELIST_GetSepColor()</code>           | Returns the color of the separator line for the given item.   |
| <code>SWIPELIST_GetSepSize()</code>            | Returns the size of the separator line.   |
| <code>SWIPELIST_GetText()</code>               | Returns the text of the given item.   |
| <code>SWIPELIST_GetTextAlign()</code>          | Returns the text alignment.   |
| <code>SWIPELIST_GetTextColor()</code>          | Returns the color of the text.  |
| <code>SWIPELIST_GetThreshold()</code>          | Returns the threshold value of the widget.  |
| <code>SWIPELIST_GetUserData()</code>           | Retrieves the data set with <code>SWIPELIST_SetUserData()</code> .  |
| <code>SWIPELIST_IsSepItem()</code>             | Returns if the given item is a separator item.  |
| <code>SWIPELIST_ItemAttachWindow()</code>      | Attaches a window to the item.  |
| <code>SWIPELIST_ItemDetachWindow()</code>      | Detaches a window.  |
| <code>SWIPELIST_OwnerDraw()</code>             | Default function for drawing the SWIPELIST widget.  |
| <code>SWIPELIST_SetAttachedWindowPos()</code>  | Sets the position of an attached window.  |
| <code>SWIPELIST_SetBitmap()</code>             | Sets a pointer to the bitmap.   |
| <code>SWIPELIST_SetBitmapSpace()</code>        | Sets the space between text and bitmap.   |
| <code>SWIPELIST_SetBkColor()</code>            | Sets the background color.  |
| <code>SWIPELIST_SetBorderSize()</code>         | Sets the size of the border.  |
| <code>SWIPELIST_SetDefaultBitmapSpace()</code> | Sets the default space between text and bitmap.   |
| <code>SWIPELIST_SetDefaultBkColor()</code>     | Sets the default background color.  |
| <code>SWIPELIST_SetDefaultBorderSize()</code>  | Sets the default size of the border.  |
| <code>SWIPELIST_SetDefaultFont()</code>        | Sets a pointer to the font used as default.   |
| <code>SWIPELIST_SetDefaultOverlap()</code>     | Sets the default overlap value used for new widgets.  |

| Routine                                      | Description   |
|--|---|
| <code>SWIPELIST_SetDefaultSepColor()</code>  | Sets the default color of the separator line.       |
| <code>SWIPELIST_SetDefaultSepSize()</code>   | Sets the default size of the separator line.        |
| <code>SWIPELIST_SetDefaultTextColor()</code> | Sets the default color of the text.                 |
| <code>SWIPELIST_SetDefaultTextAlign()</code> | Sets the default alignment of the text.             |
| <code>SWIPELIST_SetDefaultThreshold()</code> | Sets the default threshold value.                   |
| <code>SWIPELIST_SetFont()</code>             | Sets a pointer to the used font.                    |
| <code>SWIPELIST_SetItemSize()</code>         | Sets the size of the item.                          |
| <code>SWIPELIST_SetItemUserData()</code>     | Stores user data in a specific item.                |
| <code>SWIPELIST_SetOverlap()</code>          | Enables overlapping for the given SWIPELIST widget. |
| <code>SWIPELIST_SetOwnerDraw()</code>        | Sets the SWIPELIST widget to be owner drawn.        |
| <code>SWIPELIST_SetScrollPos()</code>        | Sets the scroll position of the SWIPELIST widget.   |
| <code>SWIPELIST_SetScrollPosItem()</code>    | Sets the scroll position to an item.                |
| <code>SWIPELIST_SetSepColor()</code>         | Sets the color of a separator line.                 |
| <code>SWIPELIST_SetSepSize()</code>          | Sets the size of a separator line.                  |
| <code>SWIPELIST_SetText()</code>             | Sets a text.  |
| <code>SWIPELIST_SetTextAlign()</code>        | Sets alignment of the text.                         |
| <code>SWIPELIST_SetTextColor()</code>        | Sets color of the text.                             |
| <code>SWIPELIST_SetThreshold()</code>        | Sets the threshold value.                           |
| <code>SWIPELIST_SetUserData()</code>         | Sets the extra data of a SWIPELIST widget.          |

## Defines

| Group of defines                                | Description  |
|---|--|
| <code>SWIPELIST background color indexes</code> | Color indexes for the background of SWIPELIST widgets.           |
| <code>SWIPELIST bitmap alignment flags</code>   | Flags used for <code>SWIPELIST_SetBitmap()</code> .              |
| <code>SWIPELIST border indexes</code>           | Border indexes used for <code>SWIPELIST_SetBorderSize()</code> . |
| <code>SWIPELIST font indexes</code>             | Font indexes for SWIPELIST widgets.                              |
| <code>SWIPELIST item color indexes</code>       | Color indexes for SWIPELIST widgets.                             |
| <code>SWIPELIST notification codes</code>       | Notifications sent by SWIPELIST widgets.                         |

## 6.2.28.6.1 Functions

### 6.2.28.6.1.1 SWIPELIST\_AddItem()

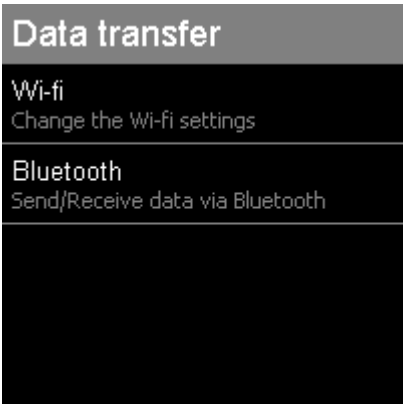
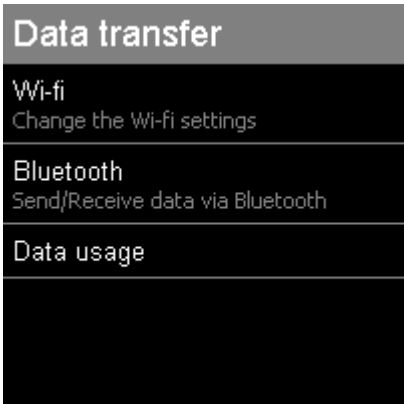
| Before  | After  |
|---|--|
|  |  |

#### Description

Adds a new item with header text to the SWIPELIST widget.

#### Prototype

```
int SWIPELIST_AddItem(    SWIPELIST_Handle  hObj,
                        const char        * sText,
                        int                ItemSize);
```

#### Parameters

| Parameter             | Description  |
|-----------------------|--|
| <code>hObj</code>     | Handle of SWIPELIST widget.                                |
| <code>sText</code>    | Pointer to the text to be handled by the SWIPELIST widget. |
| <code>ItemSize</code> | Size of the item (in pixels).                              |

#### Return value

0        on success  
1        on error.

#### Additional information

If `ItemSize` is too small for `sText` the item size will be modified by the widget. If `sText` is 0 then no header text will be drawn.

### 6.2.28.6.1.2 SWIPELIST\_AddItemText()

| Before                                       | After   |
|--|---|
| <b>Data transfer</b>                         | <b>Data transfer</b>                              |
| Wi-fi<br>Change the Wi-fi settings           | Wi-fi<br>Change the Wi-fi settings                |
| Bluetooth<br>Send/Receive data via Bluetooth | Bluetooth<br>Send/Receive data via Bluetooth      |
| Data usage                                   | Data usage<br>Shows statistic about data transfer |
|  |   |

#### Description

Adds a text to the given item of the SWIPELIST widget.

#### Prototype

```
int SWIPELIST_AddItemText( SWIPELIST_Handle hObj,
                           unsigned ItemIndex,
                           const char * sText );
```

#### Parameters

| Parameter              | Description  |
|------------------------|--|
| <code>hObj</code>      | Handle of SWIPELIST widget.                                |
| <code>ItemIndex</code> | Index of an item of the SWIPELIST widget.                  |
| <code>sText</code>     | Pointer to the text to be handled by the SWIPELIST widget. |

#### Return value

- 0 on success
- 1 on error.

#### Additional information

An item can have an undefined number of texts. Each text will begin in a new line. If the size of the items are too small for the new text the item size will be modified by the widget. If *SWIPELIST\_AddItem* on page 2088 does not set a header text then this function will set the header text at first call.

### 6.2.28.6.1.3 SWIPELIST\_AddSepItem()

| Before | After |
|--------|-------|
|        |       |

#### Description

Adds a new separator item to the SWIPELIST widget.

#### Prototype

```
int SWIPELIST_AddSepItem( SWIPELIST_Handle hObj,
                          const char * sText,
                          int ItemSize);
```

#### Parameters

| Parameter             | Description  |
|-----------------------|--|
| <code>hObj</code>     | Handle of SWIPELIST widget.                                |
| <code>sText</code>    | Pointer to the text to be handled by the SWIPELIST widget. |
| <code>ItemSize</code> | Size (in pixels) of the item used as separator.            |

#### Return value

0 on success  
1 on error.

#### Additional information

Separator items do not send any notification messages to the parent window of the SWIPELIST widget. They do not change the style if they are clicked. The separator size of the previous item will be set to 0.

### 6.2.28.6.1.4 SWIPELIST\_CreateEx()

#### Description

Creates a SWIPELIST widget of a specified size at a specified location.

#### Prototype

```
SWIPELIST_Handle SWIPELIST_CreateEx(int    x0,
                                     int    y0,
                                     int    xSize,
                                     int    ySize,
                                     WM_HWIN hParent,
                                     int    WinFlags,
                                     int    ExFlags,
                                     int    Id);
```

#### Parameters

| Parameter             | Description   |
|-----------------------|---|
| <code>x0</code>       | X-position of the button relative to the parent window.   |
| <code>y0</code>       | Y-position of the button relative to the parent window.   |
| <code>xSize</code>    | Horizontal size of the SWIPELIST widget (in pixels).  |
| <code>ySize</code>    | Vertical size of the SWIPELIST widget (in pixels).  |
| <code>hParent</code>  | Handle of parent window.  |
| <code>WinFlags</code> | Window create flags. In order to make the widget visible immediately <code>WM_CF_SHOW</code> should be used. The complete list of available parameters can be found under <i>Window create flags</i> on page 977. |
| <code>ExFlags</code>  | Not used yet, reserved for future use.  |
| <code>Id</code>       | Window ID of the widget.  |

#### Return value

Handle of the created SWIPELIST widget; 0 if the function fails.

### 6.2.28.6.1.5 SWIPELIST\_CreateIndirect()

#### Description

The prototype of this function is explained at the beginning of this chapter. Details can be found in the description of the function `<WIDGET>_CreateIndirect()` on page 992.



### 6.2.28.6.1.6 SWIPELIST\_CreateUser()

#### Description

Prototype explained at the beginning of the chapter as `<WIDGET>_CreateUser()` on page 993. For a detailed description of the parameters the function `SWIPELIST_CreateEx()` can be referred to.

### 6.2.28.6.1.7 SWIPELIST\_DeleteItem()

| Before | After |
|--------|-------|
|        |       |

#### Description

Deletes an item from the SWIPELIST widget.

#### Prototype

```
void SWIPELIST_DeleteItem(SWIPELIST_Handle hObj,
                          unsigned        ItemIndex);
```

#### Parameters

| Parameter              | Description                               |
|------------------------|---|
| <code>hObj</code>      | Handle of SWIPELIST widget.               |
| <code>ItemIndex</code> | Index of an item of the SWIPELIST widget. |

#### Additional information

If windows are attached to the item, those windows will be deleted, too.

### 6.2.28.6.1.8 SWIPELIST\_GetBitmap()

#### Description

Returns a pointer to the optional bitmap of the item.

#### Prototype

```
GUI_BITMAP *SWIPELIST_GetBitmap(SWIPELIST_Handle hObj,  
                                unsigned         ItemIndex);
```

#### Parameters

| Parameter              | Description                               |
|------------------------|---|
| <code>hObj</code>      | Handle of SWIPELIST widget.               |
| <code>ItemIndex</code> | Index of an item of the SWIPELIST widget. |

#### Return value

Pointer to the bitmap, 0 if no bitmap exist.

### 6.2.28.6.1.9 SWIPELIST\_GetBitmapSpace()

#### Description

Returns number of pixels used as space between the bitmap and the text of the SWIPELIST widget.

#### Prototype

```
int SWIPELIST_GetBitmapSpace(SWIPELIST_Handle hObj);
```

#### Parameters

| Parameter            | Description                 |
|----------------------|-----------------------------|
| <a href="#">hObj</a> | Handle of SWIPELIST widget. |

#### Return value

Number of pixels between the bitmap and the text.

### 6.2.28.6.1.10 SWIPELIST\_GetBkColor()

#### Description

Returns the specific background color of the SWIPELIST widget.

#### Prototype

```
GUI_COLOR SWIPELIST_GetBkColor(SWIPELIST_Handle hObj,  
                                unsigned          Index);
```

#### Parameters

| Parameter             | Description   |
|-----------------------|---|
| <a href="#">hObj</a>  | Handle of SWIPELIST widget.   |
| <a href="#">Index</a> | See <i>SWIPELIST background color indexes</i> on page 2158 for a full list of permitted values. |

#### Return value

Specific background color of the SWIPELIST widget.

### 6.2.28.6.1.11 SWIPELIST\_GetBorderSize()

#### Description

Returns the border of the SWIPELIST widget.

#### Prototype

```
int SWIPELIST_GetBorderSize(SWIPELIST_Handle hObj,  
                           unsigned Index);
```

#### Parameters

| Parameter             | Description   |
|-----------------------|---|
| <a href="#">hObj</a>  | Handle of SWIPELIST widget.   |
| <a href="#">Index</a> | See <i>SWIPELIST border indexes</i> on page 2160 for a full list of permitted values. |

#### Return value

Border size of the SWIPELIST widget.

### 6.2.28.6.1.12 SWIPELIST\_GetDefaultBitmapSpace()

#### Description

Returns the default number of pixels used as space between the bitmap and the text for new SWIPELIST widgets.

#### Prototype

```
int SWIPELIST_GetDefaultBitmapSpace(void);
```

#### Return value

Default number of pixels used as space between the bitmap and the text for new SWIPELIST widgets.

### 6.2.28.6.1.13 SWIPELIST\_GetDefaultBkColor()

#### Description

Returns the specific default background color of the SWIPELIST widget.

#### Prototype

```
GUI_COLOR SWIPELIST_GetDefaultBkColor(unsigned Index);
```

#### Parameters

| Parameter             | Description   |
|-----------------------|---|
| <a href="#">Index</a> | See <i>SWIPELIST background color indexes</i> on page 2158 for a full list of permitted values. |

#### Return value

Specific default background color of the SWIPELIST widget.



#### 6.2.28.6.1.14 SWIPELIST\_GetDefaultBorderSize()

##### Description

Returns the default border size (in pixels) of new SWIPELIST widgets.

##### Prototype

```
int SWIPELIST_GetDefaultBorderSize(unsigned Index);
```

##### Parameters

| Parameter             | Description   |
|-----------------------|---|
| <a href="#">Index</a> | See <i>SWIPELIST border indexes</i> on page 2160 for a full list of permitted values. |

##### Return value

Border size used for new SWIPELIST widgets.

### 6.2.28.6.1.15 SWIPELIST\_GetDefaultFont()

#### Description

Returns a pointer to the specific default font used for new SWIPELIST widgets.

#### Prototype

```
GUI_FONT *SWIPELIST_GetDefaultFont(unsigned Index);
```

#### Parameters

| Parameter             | Description   |
|-----------------------|---|
| <a href="#">Index</a> | See <i>SWIPELIST font indexes</i> on page 2161 for a full list of permitted values. |

#### Return value

Pointer to the specific default font used for new SWIPELIST widgets.

### 6.2.28.6.1.16 SWIPELIST\_GetDefaultOverlap()

#### Description

Returns the default overlap value used for new widgets.

#### Prototype

```
unsigned SWIPELIST_GetDefaultOverlap(int * pPeriod,  
                                     U8 * pFlags);
```

#### Parameters

| Parameter            | Description   |
|----------------------|---|
| <code>pPeriod</code> | <code>out</code> Pointer to store the default overlap period. |
| <code>pFlags</code>  | <code>out</code> Pointer to store the default overlap flags.  |

#### Return value

The default value for overlapping dragging operations.

#### Additional information

See `SWIPELIST_SetOverlap()` for additional information on overlapping distance.

### 6.2.28.6.1.17 SWIPELIST\_GetDefaultSepColor()

#### Description

Returns the default color of the separator line used for all new items.

#### Prototype

```
GUI_COLOR SWIPELIST_GetDefaultSepColor(void);
```

#### Return value

Default color of the separator line used for all new items.

### 6.2.28.6.1.18 SWIPELIST\_GetDefaultSepSize()

#### Description

Returns the default size (in pixels) of the separator line used for all new items.

#### Prototype

```
unsigned SWIPELIST_GetDefaultSepSize(void);
```

#### Return value

Default size (in pixels) of the separator line used for all new items.

### 6.2.28.6.1.19 SWIPELIST\_GetDefaultTextColor()

#### Description

Returns the specific default text color used by new SWIPELIST widgets.

#### Prototype

```
GUI_COLOR SWIPELIST_GetDefaultTextColor(unsigned Index);
```

#### Parameters

| Parameter             | Description   |
|-----------------------|---|
| <a href="#">Index</a> | See <i>SWIPELIST background color indexes</i> on page 2158 for a full list of permitted values. |

#### Return value

Specific default text color used by new SWIPELIST widgets.

### 6.2.28.6.1.20 SWIPELIST\_GetDefaultTextAlign()

#### Description

Returns the default text align for all new items of the SWIPELIST widget.

#### Prototype

```
int SWIPELIST_GetDefaultTextAlign(void);
```

#### Return value

Default text align for all new items of the SWIPELIST widget.

### 6.2.28.6.1.21 SWIPELIST\_GetDefaultThreshold()

#### Description

Returns the default threshold value used for new widgets. Please also refer to the function `SWIPELIST_SetThreshold()`.

#### Prototype

```
int SWIPELIST_GetDefaultThreshold(void);
```

#### Return value

Default threshold value.



### 6.2.28.6.1.22 SWIPELIST\_GetFont()

#### Description

Returns a pointer of the specified font of the SWIPELIST widget.

#### Prototype

```
GUI_FONT *SWIPELIST_GetFont(SWIPELIST_Handle hObj,  
                             unsigned Index);
```

#### Parameters

| Parameter             | Description   |
|-----------------------|---|
| <a href="#">hObj</a>  | Handle of SWIPELIST widget.   |
| <a href="#">Index</a> | See <i>SWIPELIST font indexes</i> on page 2161 for a full list of permitted values. |

#### Return value

Pointer of the specified font, 0 if index is not correct.

### 6.2.28.6.1.23 SWIPELIST\_GetItemSize()

#### Description

Returns the size (in pixels) of the given item.

#### Prototype

```
int SWIPELIST_GetItemSize(SWIPELIST_Handle hObj,  
                          unsigned ItemIndex);
```

#### Parameters

| Parameter              | Description                               |
|------------------------|---|
| <code>hObj</code>      | Handle of SWIPELIST widget.               |
| <code>ItemIndex</code> | Index of an item of the SWIPELIST widget. |

#### Return value

Size of the item, -1 if failed.

### 6.2.28.6.1.24 SWIPELIST\_GetItemUserData()

#### Description

Retrieves the previously stored user data from a given item.

#### Prototype

```
U32 SWIPELIST_GetItemUserData(SWIPELIST_Handle hObj,  
                             unsigned ItemIndex);
```

#### Parameters

| Parameter              | Description                               |
|------------------------|---|
| <code>hObj</code>      | Handle of SWIPELIST widget.               |
| <code>ItemIndex</code> | Index of an item of the SWIPELIST widget. |

#### Return value

User data of the given item.

### 6.2.28.6.1.25 SWIPELIST\_GetNumItems()

#### Description

Returns the number of items in the SWIPELIST widget.

#### Prototype

```
int SWIPELIST_GetNumItems(SWIPELIST_Handle hObj);
```

#### Parameters

| Parameter            | Description                 |
|----------------------|-----------------------------|
| <a href="#">hObj</a> | Handle of SWIPELIST widget. |

#### Return value

Number of items in the SWIPELIST widget.

### 6.2.28.6.1.26 SWIPELIST\_GetNumText()

#### Description

Returns the number of texts in the item of the SWIPELIST widget.

#### Prototype

```
int SWIPELIST_GetNumText(SWIPELIST_Handle hObj,  
                        unsigned ItemIndex);
```

#### Parameters

| Parameter              | Description                               |
|------------------------|---|
| <code>hObj</code>      | Handle of SWIPELIST widget.               |
| <code>ItemIndex</code> | Index of an item of the SWIPELIST widget. |

#### Return value

Number of texts in the item of the SWIPELIST widget.

#### Additional information

Number of texts added with the function `SWIPELIST_AddItemText()` inclusive the header text added with the function `SWIPELIST_AddItem()`.

### 6.2.28.6.1.27 SWIPELIST\_GetOverlap()

#### Description

Returns the overlap parameters of the given SWIPELIST widget.

#### Prototype

```
unsigned SWIPELIST_GetOverlap(SWIPELIST_Handle  hObj,  
                             int               * pPeriod,  
                             U8                * pFlags);
```

#### Parameters

| Parameter            | Description   |
|----------------------|---|
| <code>hObj</code>    | Handle of SWIPELIST widget.   |
| <code>pPeriod</code> | <code>out</code> Pointer to store the currently set moving back period. |
| <code>pFlags</code>  | <code>out</code> Pointer to store the currently set overlap flags.      |

#### Return value

Overlapping value in pixels.

#### Additional information

See `SWIPELIST_SetOverlap()` for additional information on overlapping distance.

### 6.2.28.6.1.28 SWIPELIST\_GetReleasedItem()

#### Description

Returns the item index of the last released item.

#### Prototype

```
int SWIPELIST_GetReleasedItem(SWIPELIST_Handle hObj);
```

#### Parameters

| Parameter            | Description                 |
|----------------------|-----------------------------|
| <a href="#">hObj</a> | Handle of SWIPELIST widget. |

#### Return value

Item index of the last released item, -1 if no item has been released.

### 6.2.28.6.1.29 SWIPELIST\_GetScrollPos()

#### Description

Returns the current scroll position (in pixels) of the SWIPELIST widget.

#### Prototype

```
int SWIPELIST_GetScrollPos(SWIPELIST_Handle hObj);
```

#### Parameters

| Parameter            | Description                 |
|----------------------|-----------------------------|
| <a href="#">hObj</a> | Handle of SWIPELIST widget. |

#### Return value

Current scroll position (in pixels) of the SWIPELIST widget.



### 6.2.28.6.1.30 SWIPELIST\_GetSelItem()

#### Description

Returns the current selected item index of the given SWIPELIST widget.

#### Prototype

```
int SWIPELIST_GetSelItem(SWIPELIST_Handle hObj);
```

#### Parameters

| Parameter            | Description                 |
|----------------------|-----------------------------|
| <a href="#">hObj</a> | Handle of SWIPELIST widget. |

#### Return value

Current selected item index, -1 if currently no item is selected.

### 6.2.28.6.1.31 SWIPELIST\_GetSepColor()

#### Description

Returns the color of the separator line for the given item.

#### Prototype

```
GUI_COLOR SWIPELIST_GetSepColor(SWIPELIST_Handle hObj,  
                                unsigned          ItemIndex);
```

#### Parameters

| Parameter              | Description                               |
|------------------------|---|
| <code>hObj</code>      | Handle of SWIPELIST widget.               |
| <code>ItemIndex</code> | Index of an item of the SWIPELIST widget. |

#### Return value

Color of the separator line of the given item.

### 6.2.28.6.1.32 SWIPELIST\_GetSepSize()

#### Description

Returns the size (in pixels) of the separator line for the given item.

#### Prototype

```
int SWIPELIST_GetSepSize(SWIPELIST_Handle hObj,  
                        unsigned ItemIndex);
```

#### Parameters

| Parameter              | Description                               |
|------------------------|---|
| <code>hObj</code>      | Handle of SWIPELIST widget.               |
| <code>ItemIndex</code> | Index of an item of the SWIPELIST widget. |

#### Return value

Size (in pixels) of the separator line for the given item.

### 6.2.28.6.1.33 SWIPELIST\_GetText()

#### Description

Returns the text of the given item.

#### Prototype

```
void SWIPELIST_GetText(SWIPELIST_Handle hObj,
                      unsigned ItemIndex,
                      unsigned TextIndex,
                      char * pBuffer,
                      int MaxSize);
```

#### Parameters

| Parameter              | Description                               |
|------------------------|---|
| <code>hObj</code>      | Handle of SWIPELIST widget.               |
| <code>ItemIndex</code> | Index of an item of the SWIPELIST widget. |
| <code>TextIndex</code> | Index of an text of an item.              |
| <code>pBuffer</code>   | Pointer to buffer filled by the function. |
| <code>MaxSize</code>   | Size of the buffer in bytes.              |

#### Additional information

The function copies the text of the given item to the buffer given by `pBuffer`. The maximum number of bytes copied to the buffer is given by `MaxSize`.

### 6.2.28.6.1.34 SWIPELIST\_GetTextAlign()

#### Description

Returns the text alignment of the given item.

#### Prototype

```
int SWIPELIST_GetTextAlign(SWIPELIST_Handle hObj,  
                           unsigned        ItemIndex);
```

#### Parameters

| Parameter              | Description                               |
|------------------------|---|
| <code>hObj</code>      | Handle of SWIPELIST widget.               |
| <code>ItemIndex</code> | Index of an item of the SWIPELIST widget. |

#### Return value

Text alignment of the item.

### 6.2.28.6.1.35 SWIPELIST\_GetTextColor()

#### Description

Returns the specific text color of the SWIPELIST widget.

#### Prototype

```
GUI_COLOR SWIPELIST_GetTextColor(SWIPELIST_Handle hObj,  
                                unsigned          Index);
```

#### Parameters

| Parameter             | Description   |
|-----------------------|---|
| <a href="#">hObj</a>  | Handle of SWIPELIST widget.   |
| <a href="#">Index</a> | See <i>SWIPELIST item color indexes</i> on page 2162 for a full list of permitted values. |

#### Return value

Specific text color of the SWIPELIST widget.

### 6.2.28.6.1.36 SWIPELIST\_GetThreshold()

#### Description

Returns the minimum number of pixels required for a swipe operation.

#### Prototype

```
int SWIPELIST_GetThreshold(SWIPELIST_Handle hObj);
```

#### Parameters

| Parameter            | Description                 |
|----------------------|-----------------------------|
| <a href="#">hObj</a> | Handle of SWIPELIST widget. |

#### Return value

Threshold value used by the widget.

#### Additional information

Please also refer to *SWIPELIST\_SetThreshold* on page 2156.

### 6.2.28.6.1.37 SWIPELIST\_GetUserData()

#### Description

Prototype explained at the beginning of the chapter as `<WIDGET>_GetUserData()` on page 994.



### 6.2.28.6.1.38 SWIPELIST\_IsSepItem()

#### Description

Returns if the given item is a separator item.

#### Prototype

```
int SWIPELIST_IsSepItem(SWIPELIST_Handle hObj,  
                        U32              ItemIndex);
```

#### Parameters

| Parameter              | Description                               |
|------------------------|---|
| <code>hObj</code>      | Handle of SWIPELIST widget.               |
| <code>ItemIndex</code> | Index of an item of the SWIPELIST widget. |

#### Return value

- 1 If the item is a separator item.
- 0 If the item is not a separator item.
- 1 Error: Index out of bounds.

### 6.2.28.6.1.39 SWIPELIST\_ItemAttachWindow()

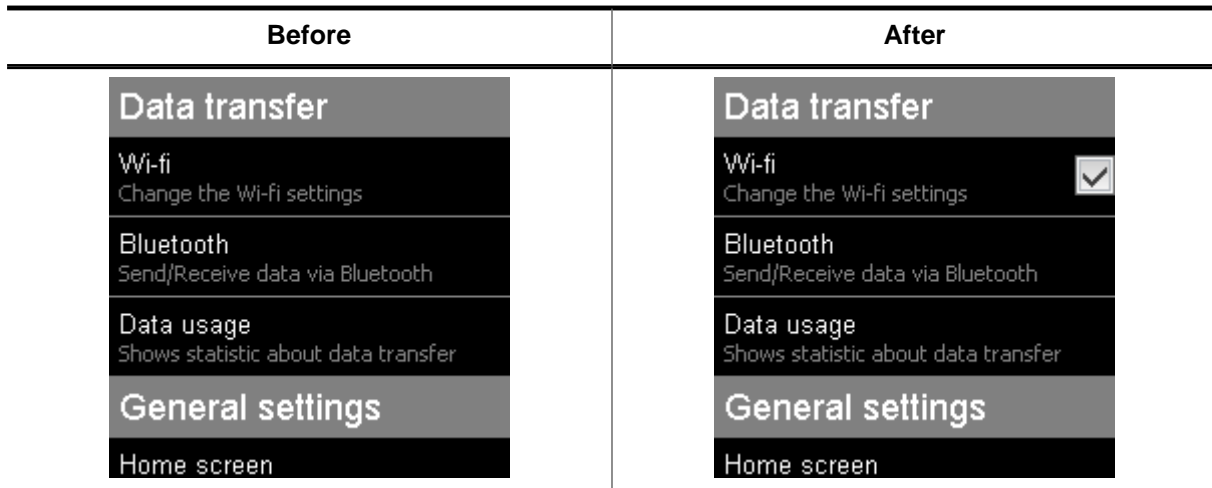

#### Description

Attaches the window/widget to the given item of the SWIPELIST widget.

#### Prototype

```
int SWIPELIST_ItemAttachWindow(SWIPELIST_Handle hObj,
                               unsigned         ItemIndex,
                               WM_HWIN        hWin,
                               int             x0,
                               int             y0);
```

#### Parameters

| Parameter              | Description  |
|------------------------|--|
| <code>hObj</code>      | Handle of SWIPELIST widget.                                |
| <code>ItemIndex</code> | Index of an item of the SWIPELIST widget.                  |
| <code>hWin</code>      | Handle of the window that should be attached.              |
| <code>x0</code>        | X-position of the window that should be added to the item. |
| <code>y0</code>        | Y-position of the window that should be added to the item. |

#### Return value

0        on success  
1        on error.

#### Additional information

If the size of the window is bigger then the item size the window will not be attached to the item and the function returns 1. If the given position will bring the window out of the item area the position will be fixed to the end of the item area.

### 6.2.28.6.1.40 SWIPELIST\_ItemDetachWindow()

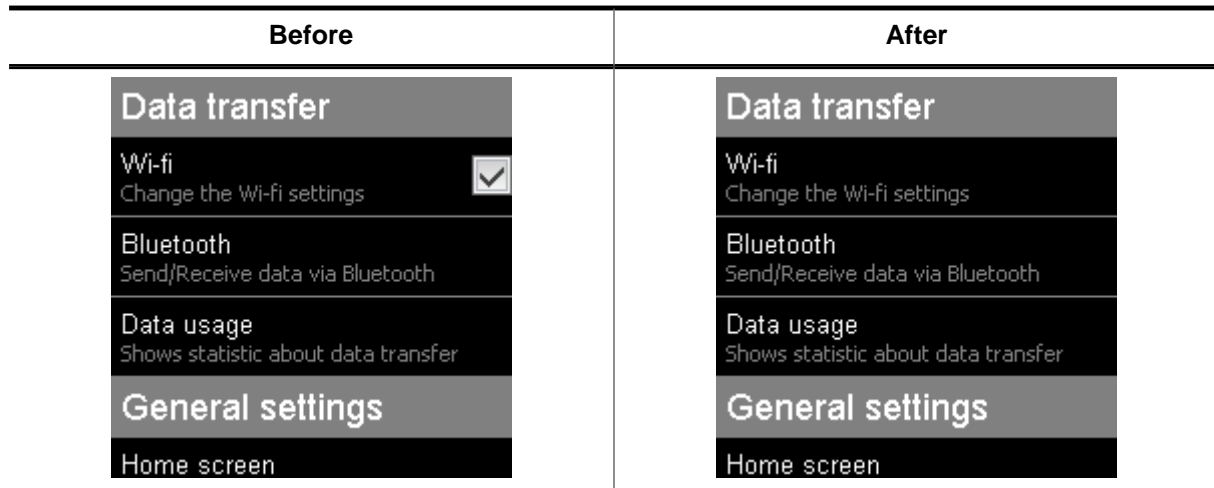

#### Description

Detaches the window from the item of the SWIPELIST widget.

#### Prototype

```
void SWIPELIST_ItemDetachWindow(SWIPELIST_Handle hObj,
                                WM_HWIN          hWin);
```

#### Parameters

| Parameter            | Description                                   |
|----------------------|---|
| <a href="#">hObj</a> | Handle of SWIPELIST widget.                   |
| <a href="#">hWin</a> | Handle of the window that should be detached. |

#### 6.2.28.6.1.41 SWIPELIST\_OwnerDraw()

##### Description

Default function to draw an item of the SWIPELIST widget.

##### Prototype

```
int SWIPELIST_OwnerDraw(const WIDGET_ITEM_DRAW_INFO * pDrawItemInfo);
```

##### Parameters

| Parameter                  | Description  |
|----------------------------|--|
| <code>pDrawItemInfo</code> | Pointer to a <code>WIDGET_ITEM_DRAW_INFO</code> structure. |

##### Additional information

This function is useful if *SWIPELIST\_SetOwnerDraw* on page 2148 has been used. It can be used from the application defined drawing function to display anything of the item by the SWIPELIST widget.

### 6.2.28.6.1.42 SWIPELIST\_SetAttachedWindowPos()

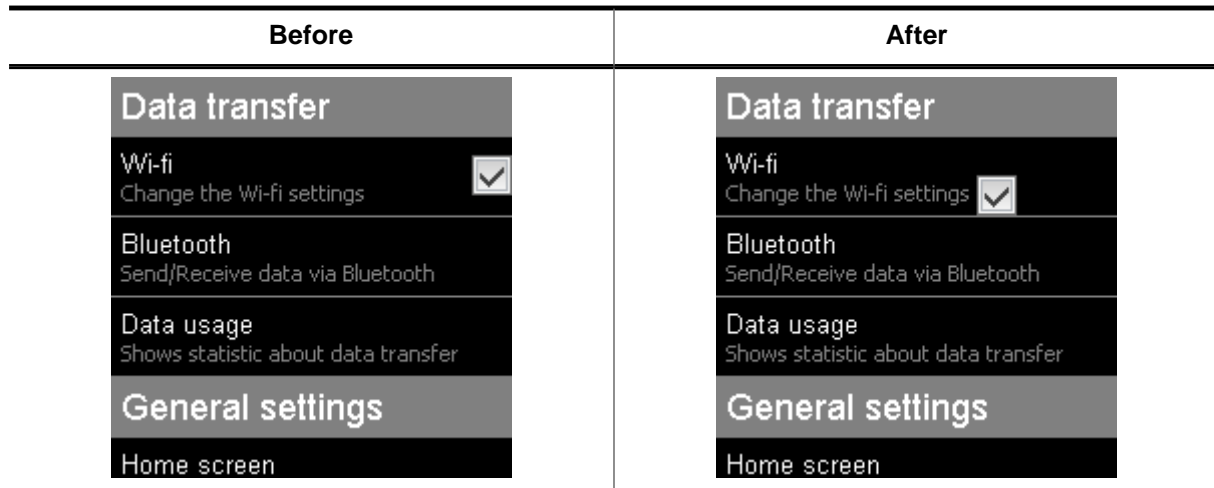

#### Description

Sets the position of the attached window in the item of the SWIPELIST.

#### Prototype

```
void SWIPELIST_SetAttachedWindowPos(SWIPELIST_Handle hObj,
                                     WM_HWIN         hWin,
                                     int              x0,
                                     int              y0);
```

#### Parameters

| Parameter         | Description   |
|-------------------|---|
| <code>hObj</code> | Handle of SWIPELIST widget.   |
| <code>hWin</code> | Handle of the window that is attached to an item of the SWIPELIST widget. |
| <code>x0</code>   | New x-position of the window that is attached to an item.                 |
| <code>y0</code>   | New y-position of the window that is attached to an item.                 |

### 6.2.28.6.1.43 SWIPELIST\_SetBitmap()

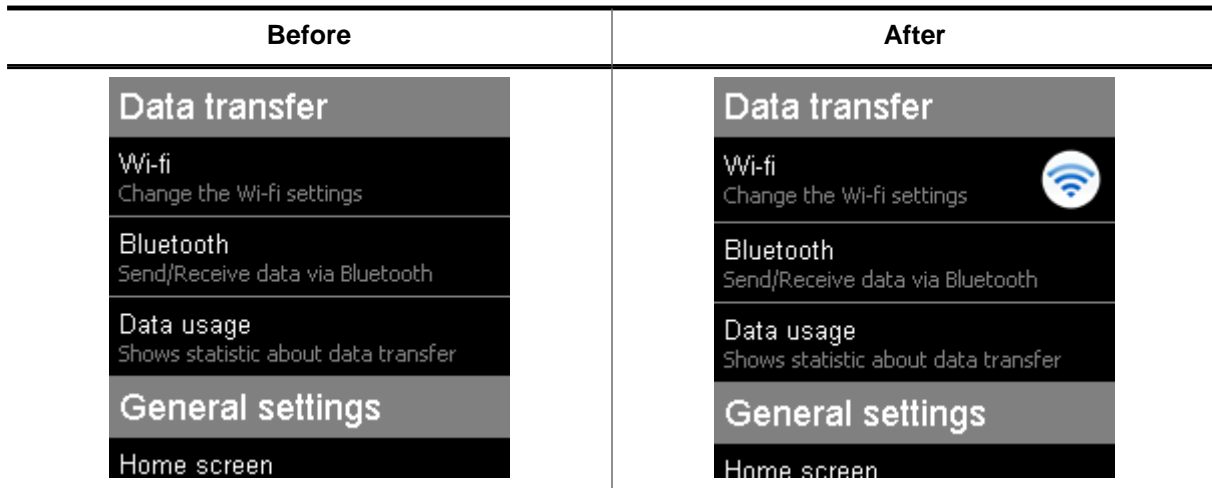

#### Description

Sets a bitmap to be displayed with the given alignment Within the item.

#### Prototype

```
void SWIPELIST_SetBitmap(    SWIPELIST_Handle  hObj,
                           unsigned  ItemIndex,
                           int       Align,
                           const GUI_BITMAP * pBitmap);
```

#### Parameters

| Parameter              | Description   |
|------------------------|---|
| <code>hObj</code>      | Handle of SWIPELIST widget.   |
| <code>ItemIndex</code> | Index of an item of the SWIPELIST widget.   |
| <code>Align</code>     | OR-combination of bitmap alignment flags. See <i>SWIPELIST bitmap alignment flags</i> on page 2159. |
| <code>pBitmap</code>   | Pointer to an bitmap structure to be displayed.   |

#### Additional information

If the alignment of the bitmap is vertical and horizontal central then no text will be displayed.

#### 6.2.28.6.1.44 SWIPELIST\_SetBitmapSpace()

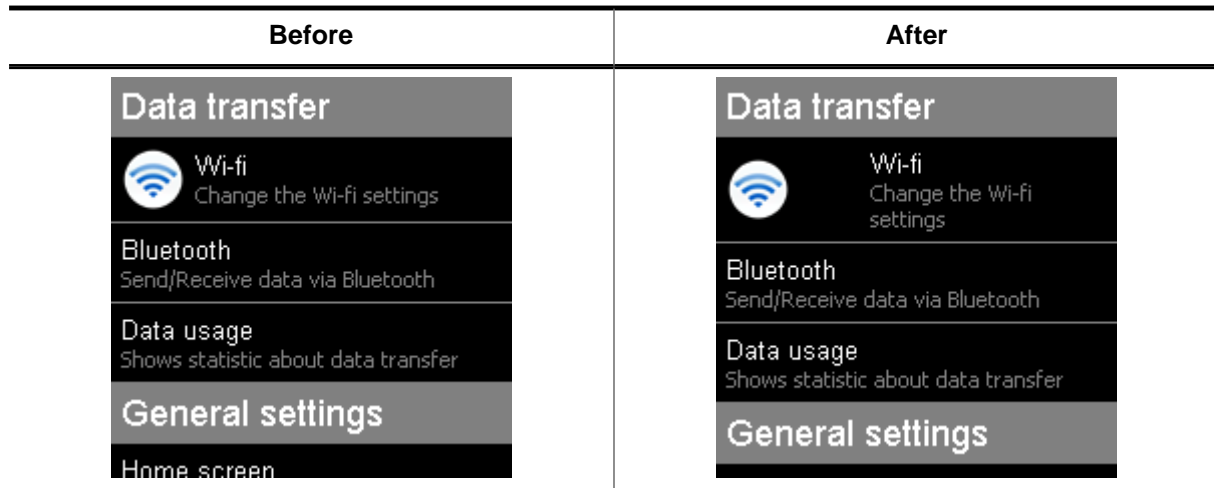

#### Description

Set the space (in pixels) between the text and the bitmap of the SWIPELIST widget.

#### Prototype

```
void SWIPELIST_SetBitmapSpace(SWIPELIST_Handle hObj,
                              unsigned         Size);
```

#### Parameters

| Parameter            | Description                     |
|----------------------|---------------------------------|
| <a href="#">hObj</a> | Handle of SWIPELIST widget.     |
| <a href="#">Size</a> | Number of pixels used as space. |

### 6.2.28.6.1.45 SWIPELIST\_SetBkColor()

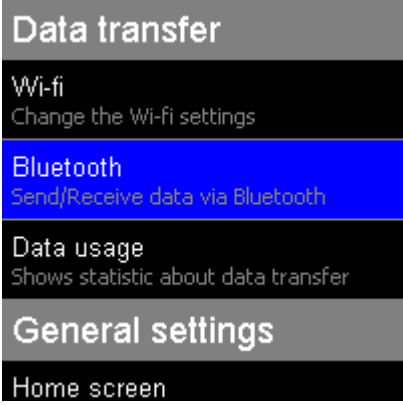
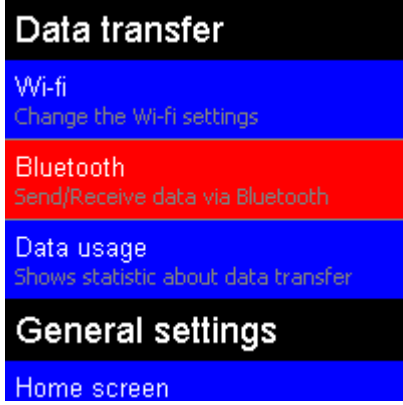
| Before  | After  |
|---|--|
|  |  |

#### Description

Sets the specific background color of the SWIPELIST widget.

#### Prototype

```
void SWIPELIST_SetBkColor(SWIPELIST_Handle hObj,
                          unsigned Index,
                          GUI_COLOR Color);
```

#### Parameters

| Parameter          | Description   |
|--------------------|---|
| <code>hObj</code>  | Handle of SWIPELIST widget.   |
| <code>Index</code> | See <i>SWIPELIST background color indexes</i> on page 2158 for a full list of permitted values. |
| <code>Color</code> | Background color to be set.   |

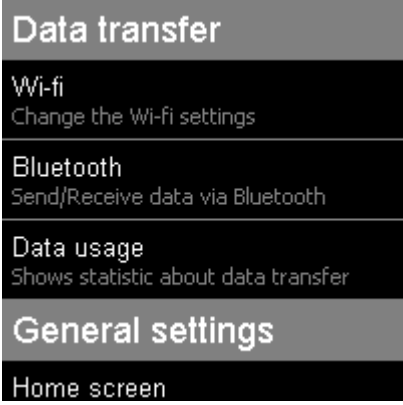
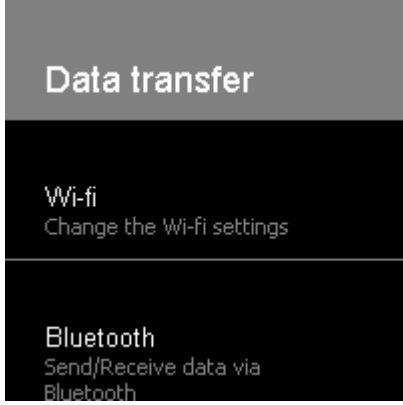

### 6.2.28.6.1.46 SWIPELIST\_SetBorderSize()

| Before  | After  |
|---|--|
|  |  |

#### Description

Sets the specific border size (in pixels) of the SWIPELIST widget.

#### Prototype

```
void SWIPELIST_SetBorderSize(SWIPELIST_Handle hObj,
                             unsigned Index,
                             unsigned Size);
```

#### Parameters

| Parameter             | Description   |
|-----------------------|---|
| <a href="#">hObj</a>  | Handle of SWIPELIST widget.   |
| <a href="#">Index</a> | See <i>SWIPELIST border indexes</i> on page 2160 for a full list of permitted values. |
| <a href="#">Size</a>  | Number of pixels used as border.  |

### 6.2.28.6.1.47 SWIPELIST\_SetDefaultBitmapSpace()

#### Description

Sets the default space (in pixels) between text and bitmap for new SWIPELIST widgets.

#### Prototype

```
void SWIPELIST_SetDefaultBitmapSpace(unsigned Size);
```

#### Parameters

| Parameter | Description                     |
|-----------|---------------------------------|
| Size      | Number of pixels used as space. |

### 6.2.28.6.1.48 SWIPELIST\_SetDefaultBkColor()

#### Description

Sets the default color of the specific background for new SWIPELIST widget.

#### Prototype

```
void SWIPELIST_SetDefaultBkColor(unsigned Index,  
                                GUI_COLOR Color);
```

#### Parameters

| Parameter             | Description   |
|-----------------------|---|
| <a href="#">Index</a> | See <i>SWIPELIST background color indexes</i> on page 2158 for a full list of permitted values. |
| <a href="#">Color</a> | Background color to be set.   |

### 6.2.28.6.1.49 SWIPELIST\_SetDefaultBorderSize()

#### Description

Sets the default size (in pixels) of the specific border for new SWIPELIST widgets.

#### Prototype

```
void SWIPELIST_SetDefaultBorderSize(unsigned Index,  
                                     unsigned Size);
```

#### Parameters

| Parameter             | Description   |
|-----------------------|---|
| <a href="#">Index</a> | See <i>SWIPELIST border indexes</i> on page 2160 for a full list of permitted values. |
| <a href="#">Size</a>  | Number of pixels used as border.  |

### 6.2.28.6.1.50 SWIPELIST\_SetDefaultFont()

#### Description

Sets the pointer to the default font to display the specific text of new SWIPELIST widgets.

#### Prototype

```
void SWIPELIST_SetDefaultFont(    unsigned   Index,  
                                const GUI_FONT * pFont);
```

#### Parameters

| Parameter             | Description   |
|-----------------------|---|
| <a href="#">Index</a> | See <i>SWIPELIST font indexes</i> on page 2161 for a full list of permitted values. |
| <a href="#">pFont</a> | Pointer to the font to be used.   |

### 6.2.28.6.1.51 SWIPELIST\_SetDefaultOverlap()

#### Description

Sets the default overlap value used for new widgets.

#### Prototype

```
void SWIPELIST_SetDefaultOverlap(unsigned Overlap,
                                int      Period,
                                U8      Flags);
```

#### Parameters

| Parameter | Description  |
|-----------|--|
| Overlap   | The new default value to be set for overlapping dragging operations.   |
| Period    | Default period to be used for moving back when the list was released while being dragged into overlap area.  |
| Flags     | Default overlap flags.<br>WM_MOTION_OVERLAP_TOP to enable overlap at the top edge.<br>WM_MOTION_OVERLAP_BOTTOM to enable overlap at the bottom edge. |

#### Additional information

See SWIPELIST\_SetOverlap() for additional information on overlapping distance.

### 6.2.28.6.1.52 SWIPELIST\_SetDefaultSepColor()

#### Description

Sets the default color of the separator line for new items.

#### Prototype

```
void SWIPELIST_SetDefaultSepColor(GUI_COLOR Color);
```

#### Parameters

| Parameter | Description                  |
|-----------|------------------------------|
| Color     | Color of the separator line. |

### 6.2.28.6.1.53 SWIPELIST\_SetDefaultSepSize()

#### Description

Sets the default size (in pixels) of the separator line for new items.

#### Prototype

```
void SWIPELIST_SetDefaultSepSize(unsigned Size);
```

#### Parameters

| Parameter | Description                              |
|-----------|--|
| Size      | Number of pixels used as separator line. |



### 6.2.28.6.1.54 SWIPELIST\_SetDefaultTextColor()

#### Description

Sets the default color of the specific text for new SWIPELIST widgets.

#### Prototype

```
void SWIPELIST_SetDefaultTextColor(unsigned Index,  
                                   GUI_COLOR Color);
```

#### Parameters

| Parameter             | Description   |
|-----------------------|---|
| <a href="#">Index</a> | See <i>SWIPELIST item color indexes</i> on page 2162 for a full list of permitted values. |
| <a href="#">Color</a> | <a href="#">Color</a> used for the specific text.   |

### 6.2.28.6.1.55 SWIPELIST\_SetDefaultTextAlign()

#### Description

Sets the default text alignment for new items.

#### Prototype

```
void SWIPELIST_SetDefaultTextAlign(int Align);
```

#### Parameters

| Parameter             | Description   |
|-----------------------|---|
| <a href="#">Align</a> | Text alignment to be set (see <a href="#">GUI_SetTextAlign()</a> ). |

### 6.2.28.6.1.56 SWIPELIST\_SetDefaultThreshold()

#### Description

Sets the default threshold value to be used for new widgets. For details please also refer to `SWIPELIST_SetThreshold()`.

#### Prototype

```
void SWIPELIST_SetDefaultThreshold(int Threshold);
```

#### Parameters

| Parameter              | Description   |
|------------------------|---|
| <code>Threshold</code> | The new default value to be set for minimum amount of movement. |

### 6.2.28.6.1.57 SWIPELIST\_SetFont()

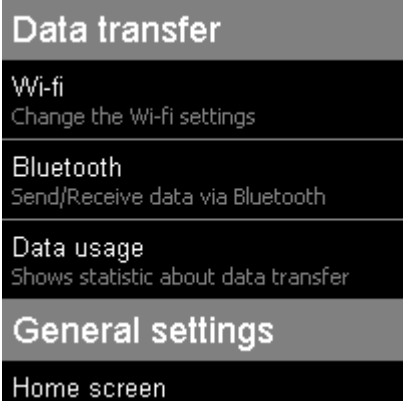
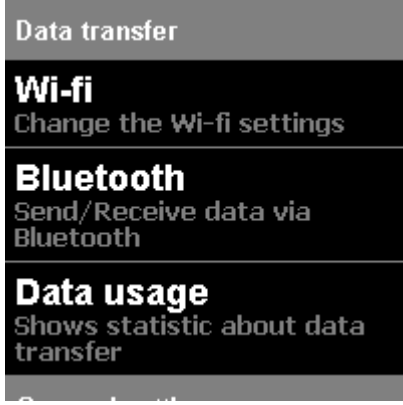
| Before  | After  |
|---|--|
|  <p>Data transfer</p> <p>Wi-fi<br/>Change the Wi-fi settings</p> <p>Bluetooth<br/>Send/Receive data via Bluetooth</p> <p>Data usage<br/>Shows statistic about data transfer</p> <p>General settings</p> <p>Home screen</p> |  <p>Data transfer</p> <p><b>Wi-fi</b><br/>Change the Wi-fi settings</p> <p><b>Bluetooth</b><br/>Send/Receive data via Bluetooth</p> <p><b>Data usage</b><br/>Shows statistic about data transfer</p> |

#### Description

Sets the pointer to the font used for display the specific text of the SWIPELIST widget.

#### Prototype

```
void SWIPELIST_SetFont(      SWIPELIST_Handle  hObj,
                             unsigned          Index,
                             const GUI_FONT    * pFont);
```

#### Parameters

| Parameter             | Description   |
|-----------------------|---|
| <a href="#">hObj</a>  | Handle of SWIPELIST widget.   |
| <a href="#">Index</a> | See <i>SWIPELIST font indexes</i> on page 2161 for a full list of permitted values. |
| <a href="#">pFont</a> | Pointer to the font to be used.   |

### 6.2.28.6.1.58 SWIPELIST\_SetItemSize()

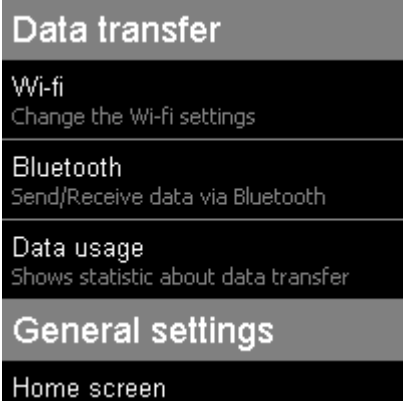
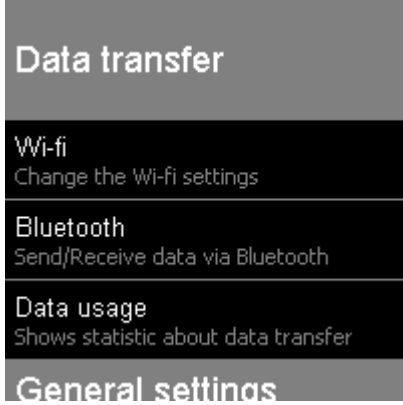
| Before  | After  |
|---|--|
|  |  |

#### Description

Sets the size of the given item.

#### Prototype

```
void SWIPELIST_SetItemSize(SWIPELIST_Handle hObj,
                           unsigned         ItemIndex,
                           unsigned         Size);
```

#### Parameters

| Parameter              | Description                               |
|------------------------|---|
| <code>hObj</code>      | Handle of SWIPELIST widget.               |
| <code>ItemIndex</code> | Index of an item of the SWIPELIST widget. |
| <code>Size</code>      | Number of pixels used for the item.       |

### 6.2.28.6.1.59 SWIPELIST\_SetItemUserData()

#### Description

Sets a 32 bit value assigned to the given item of the SWIPELIST widget.

#### Prototype

```
void SWIPELIST_SetItemUserData(SWIPELIST_Handle hObj,  
                               unsigned         ItemIndex,  
                               U32              UserData);
```

#### Parameters

| Parameter                 | Description                               |
|---------------------------|---|
| <a href="#">hObj</a>      | Handle of SWIPELIST widget.               |
| <a href="#">ItemIndex</a> | Index of an item of the SWIPELIST widget. |
| <a href="#">UserData</a>  | 32 bit user data to be stored.            |

### 6.2.28.6.1.60 SWIPELIST\_SetOverlap()

#### Description

Enables overlapping for the given SWIPELIST widget.

When active, the widget also sends notifications to its parent window when the overlapping area is entered and left. See *SWIPELIST notification codes* on page 2163.

#### Prototype

```
void SWIPELIST_SetOverlap(SWIPELIST_Handle hObj,
                          unsigned         Overlap,
                          int              Period,
                          U8               Flags);
```

#### Parameters

| Parameter            | Description  |
|----------------------|--|
| <code>hObj</code>    | Handle of SWIPELIST widget.  |
| <code>Overlap</code> | Overlapping distance in pixels.  |
| <code>Period</code>  | <code>Period</code> in ms for moving back the list when it was released after it was dragged into the overlap area.  |
| <code>Flags</code>   | OR-combination of overlap flags:<br><code>WM_MOTION_OVERLAP_TOP</code> to enable overlap at the top edge.<br><code>WM_MOTION_OVERLAP_BOTTOM</code> to enable overlap at the bottom edge. |

#### Additional information

The overlapping value determines how many additional pixels the SWIPELIST can be dragged when the beginning or end of the list is reached. When the list is dragged and released, the list will move back to the normal position.

The table below demonstrates this. The left image shows the list being at the top and in the right image the list is being dragged by the set overlapping distance.

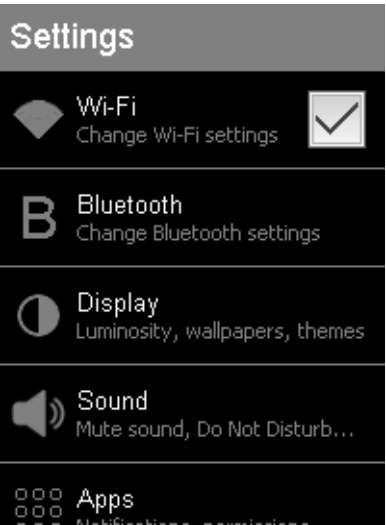
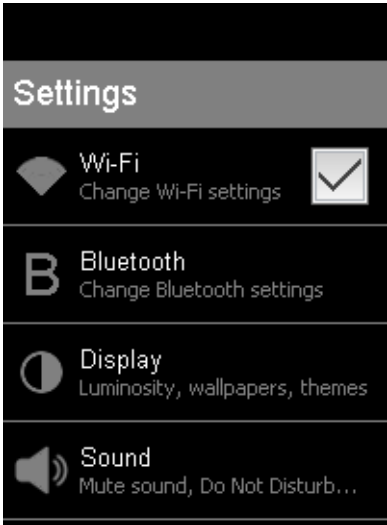
| Default   | Dragged by overlapping distance  |
|---|--|
|  <p>The screenshot shows a settings list with items: Settings, Wi-Fi (checked), Bluetooth, Display, Sound, and Apps. The list is positioned at the top of the screen, with a dark background and light text.</p> |  <p>The screenshot shows the same settings list as the left image, but it is dragged down by a certain distance, illustrating the overlapping effect. The list is partially obscured by a dark bar at the top of the screen.</p> |

### 6.2.28.6.1.61 SWIPELIST\_SetOwnerDraw()

#### Description

Sets the SWIPELIST widget to be owner drawn.

#### Prototype

```
void SWIPELIST_SetOwnerDraw(SWIPELIST_Handle hObj,  
                             WIDGET_DRAW_ITEM_FUNC * pfDrawItem);
```

#### Parameters

| Parameter                  | Description                     |
|----------------------------|---------------------------------|
| <a href="#">hObj</a>       | Handle of SWIPELIST widget.     |
| <a href="#">pfDrawItem</a> | Pointer to owner draw function. |

#### Supported commands

- WIDGET\_ITEM\_DRAW\_BACKGROUND
- WIDGET\_ITEM\_DRAW\_TEXT
- WIDGET\_ITEM\_DRAW\_BITMAP
- WIDGET\_ITEM\_DRAW\_SEP

#### Additional information

This function sets a pointer to a function which will be called by the widget if an item of the SWIPELIST has to be drawn. It gives you the possibility to draw complete customized items. [pfDrawItem](#) is a pointer to an application defined function of type WIDGET\_DRAW\_ITEM\_FUNC which is explained at the beginning of the chapter.

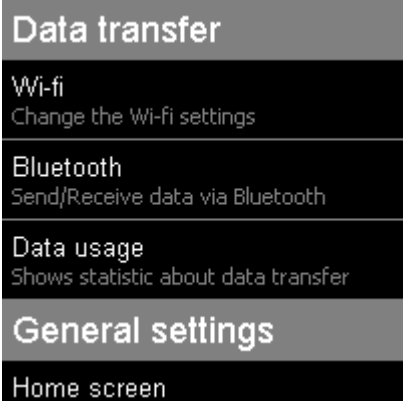
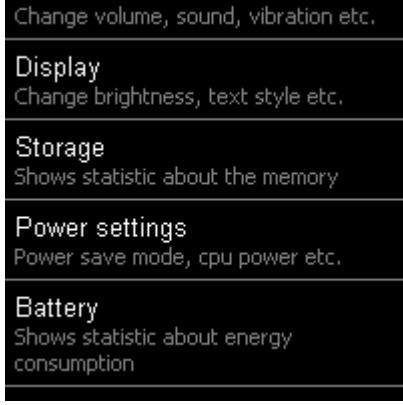

### 6.2.28.6.1.62 SWIPELIST\_SetScrollPos()

| Before  | After  |
|---|--|
|  |  |

#### Description

Sets the scroll position (in pixels) of the SWIPELIST widget.

#### Prototype

```
void SWIPELIST_SetScrollPos(SWIPELIST_Handle hObj,
                           int Pos);
```

#### Parameters

| Parameter         | Description                              |
|-------------------|--|
| <code>hObj</code> | Handle of SWIPELIST widget.              |
| <code>Pos</code>  | Number of pixels of the scroll position. |

### 6.2.28.6.1.63 SWIPELIST\_SetScrollPosItem()

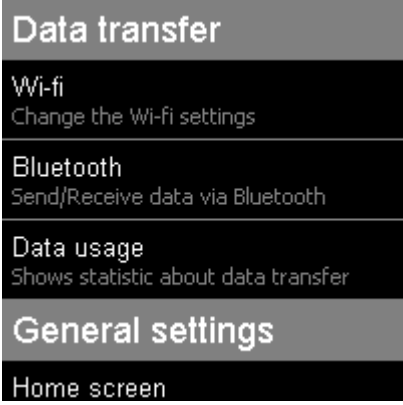
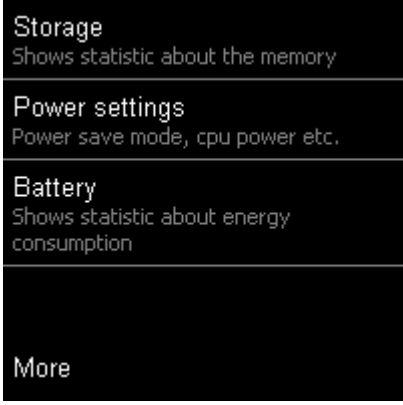
| Before   | After   |
|--|---|
|  <p>The screenshot shows a settings menu with the following items from top to bottom: Data transfer (highlighted), Wi-fi (Change the Wi-fi settings), Bluetooth (Send/Receive data via Bluetooth), Data usage (Shows statistic about data transfer), General settings (highlighted), and Home screen.</p> |  <p>The screenshot shows the same settings menu after scrolling. The visible items are: Storage (Shows statistic about the memory), Power settings (Power save mode, cpu power etc.), Battery (Shows statistic about energy consumption), and More.</p> |

#### Description

Sets the scroll position to see the given item on first position.

#### Prototype

```
void SWIPELIST_SetScrollPosItem(SWIPELIST_Handle hObj,
                                unsigned         ItemIndex);
```

#### Parameters

| Parameter              | Description                               |
|------------------------|---|
| <code>hObj</code>      | Handle of SWIPELIST widget.               |
| <code>ItemIndex</code> | Index of an item of the SWIPELIST widget. |

#### Additional information

If the list is too short to set the scroll position to see the given item on first position, the scroll position will be set to the end of the list.

### 6.2.28.6.1.64 SWIPELIST\_SetSepColor()

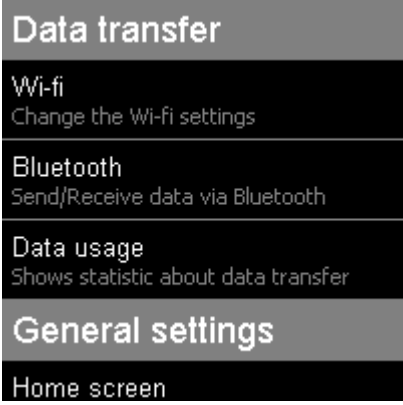
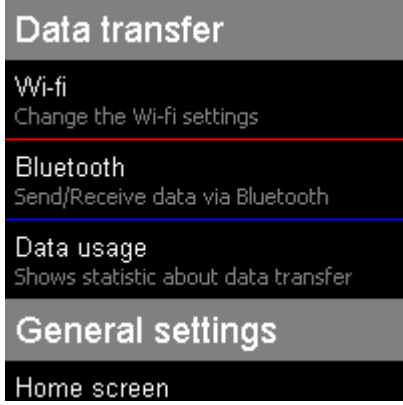
| Before  | After  |
|---|--|
|  |  |

#### Description

Sets the color of the separator line of a given item.

#### Prototype

```
void SWIPELIST_SetSepColor(SWIPELIST_Handle hObj,
                           unsigned        ItemIndex,
                           GUI_COLOR       Color);
```

#### Parameters

| Parameter              | Description  |
|------------------------|--|
| <code>hObj</code>      | Handle of SWIPELIST widget.                                  |
| <code>ItemIndex</code> | Index of an item of the SWIPELIST widget.                    |
| <code>Color</code>     | <code>Color</code> of the separator line of a specific item. |

### 6.2.28.6.1.65 SWIPELIST\_SetSepSize()

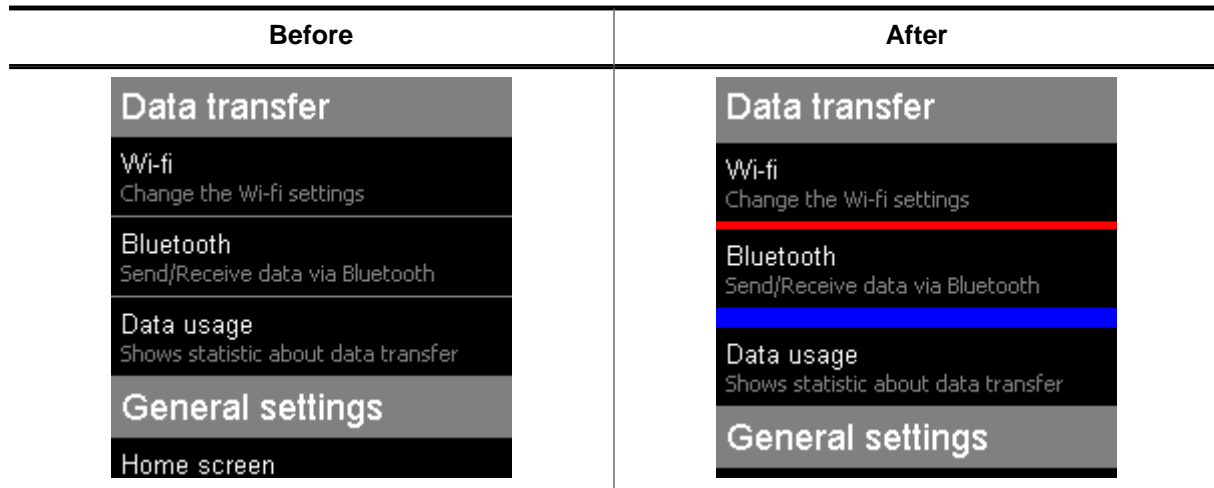

#### Description

Sets size (in pixels) of the separator line of a given item.

#### Prototype

```
void SWIPELIST_SetSepSize(SWIPELIST_Handle hObj,
                          unsigned        ItemIndex,
                          int             Size);
```

#### Parameters

| Parameter              | Description  |
|------------------------|--|
| <code>hObj</code>      | Handle of SWIPELIST widget.                              |
| <code>ItemIndex</code> | Index of an item of the SWIPELIST widget.                |
| <code>Size</code>      | Number of pixel used for the size of the separator line. |

### 6.2.28.6.1.66 SWIPELIST\_SetText()

| Before  | After  |
|---|--|
| <div style="background-color: #cccccc; padding: 2px;"><b>Data transfer</b></div> <div style="background-color: #333333; color: white; padding: 2px;">Wi-fi<br/>Change the Wi-fi settings</div> <div style="background-color: #333333; color: white; padding: 2px;">Bluetooth<br/>Send/Receive data via Bluetooth</div> <div style="background-color: #333333; color: white; padding: 2px;">Data usage<br/>Shows statistic about data transfer</div> <div style="background-color: #cccccc; padding: 2px;"><b>General settings</b></div> <div style="background-color: #333333; color: white; padding: 2px;">Home screen</div> | <div style="background-color: #cccccc; padding: 2px;"><b>Data transfer</b></div> <div style="background-color: #333333; color: white; padding: 2px;">Wireless<br/>Change the Wi-fi settings</div> <div style="background-color: #333333; color: white; padding: 2px;">Bluetooth<br/>Send/Receive data via Bluetooth</div> <div style="background-color: #333333; color: white; padding: 2px;">Data usage<br/>Shows statistic about data transfer</div> <div style="background-color: #cccccc; padding: 2px;"><b>General settings</b></div> <div style="background-color: #333333; color: white; padding: 2px;">Home screen</div> |

#### Description

Sets/Changes a text of an item.

#### Prototype

```
void SWIPELIST_SetText(SWIPELIST_Handle hObj,
                      unsigned ItemIndex,
                      unsigned TextIndex,
                      char * s);
```

#### Parameters

| Parameter              | Description                               |
|------------------------|---|
| <code>hObj</code>      | Handle of SWIPELIST widget.               |
| <code>ItemIndex</code> | Index of an item of the SWIPELIST widget. |
| <code>TextIndex</code> | Index of the text in the item.            |
| <code>sText</code>     | Text to be displayed.                     |

### 6.2.28.6.1.67 SWIPELIST\_SetTextAlign()

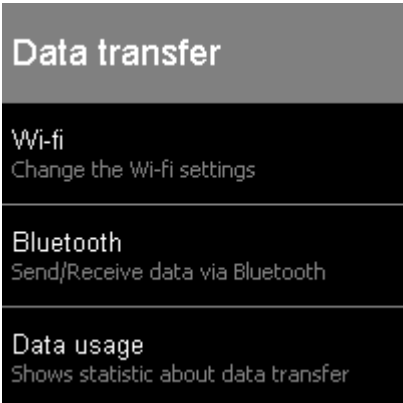
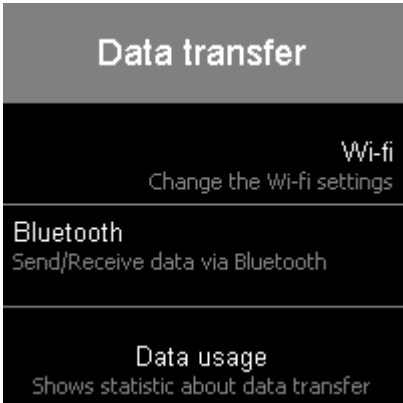
| Before  | After  |
|---|--|
|  |  |

#### Description

Sets the text alignment of a given item.

#### Prototype

```
void SWIPELIST_SetTextAlign(SWIPELIST_Handle hObj,
                           unsigned        ItemIndex,
                           int             Align);
```

#### Parameters

| Parameter              | Description   |
|------------------------|---|
| <code>hObj</code>      | Handle of SWIPELIST widget.   |
| <code>ItemIndex</code> | Index of an item of the SWIPELIST widget.   |
| <code>Align</code>     | Text alignment to be set. List of flags can be found under <i>Text alignment flags</i> on page 252. |

### 6.2.28.6.1.68 SWIPELIST\_SetTextColor()

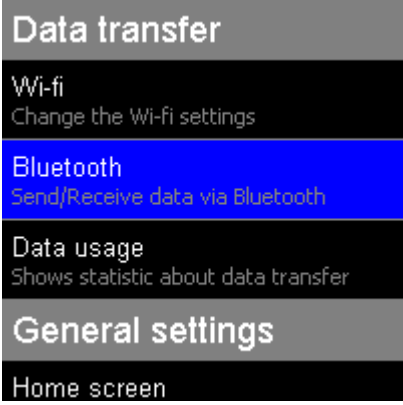
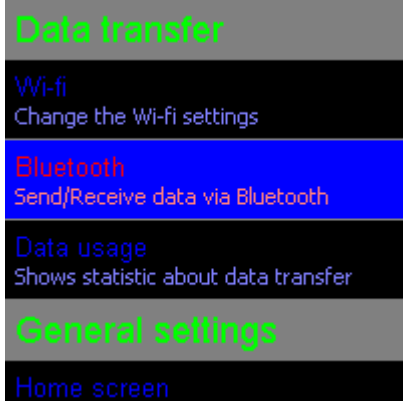
| Before  | After  |
|---|--|
|  <p>Data transfer</p> <p>Wi-fi<br/>Change the Wi-fi settings</p> <p>Bluetooth<br/>Send/Receive data via Bluetooth</p> <p>Data usage<br/>Shows statistic about data transfer</p> <p>General settings</p> <p>Home screen</p> |  <p>Data transfer</p> <p>Wi-fi<br/>Change the Wi-fi settings</p> <p>Bluetooth<br/>Send/Receive data via Bluetooth</p> <p>Data usage<br/>Shows statistic about data transfer</p> <p>General settings</p> <p>Home screen</p> |

#### Description

Sets the color of the text used by the SWIPELIST widget.

#### Prototype

```
void SWIPELIST_SetTextColor(SWIPELIST_Handle hObj,
                           unsigned Index,
                           GUI_COLOR Color);
```

#### Parameters

| Parameter          | Description   |
|--------------------|---|
| <code>hObj</code>  | Handle of SWIPELIST widget.   |
| <code>Index</code> | See <i>SWIPELIST item color indexes</i> on page 2162 for a full list of permitted values. |
| <code>Color</code> | <code>Color</code> for the text.  |

### 6.2.28.6.1.69 SWIPELIST\_SetThreshold()

#### Description

Sets the minimum distance required for a scroll operation.

#### Prototype

```
int SWIPELIST_SetThreshold(SWIPELIST_Handle hObj,  
                           int Threshold);
```

#### Parameters

| Parameter              | Description                 |
|------------------------|-----------------------------|
| <code>hObj</code>      | Handle of SWIPELIST widget. |
| <code>Threshold</code> | New threshold value.        |

#### Return value

Previous threshold value.

#### Additional information

Pressing the PID selects the swipelists item below the PID position. Swiping the PID in pressed state deselects the item and starts the swipe operation. The threshold value defines the minimum number of pixels required to release the selection and start swiping.



### 6.2.28.6.1.70 SWIPELIST\_SetUserData()

#### Description

Prototype explained at the beginning of the chapter as `<WIDGET>_SetUserData()` on page 995.

## 6.2.28.6.2 Defines

### 6.2.28.6.2.1 SWIPELIST background color indexes

#### Description

Color indexes used for SWIPELIST routines to return or set the background color of SWIPELIST items.

#### Definition

```
#define SWIPELIST_CI_BK_ITEM_UNSEL    0
#define SWIPELIST_CI_BK_ITEM_SEL     1
#define SWIPELIST_CI_BK_SEP_ITEM     2
#define SWIPELIST_CI_BK              3
```

#### Symbols

| Definition                                 | Description                       |
|--|-----------------------------------|
| <a href="#">SWIPELIST_CI_BK_ITEM_UNSEL</a> | Background of an unselected item. |
| <a href="#">SWIPELIST_CI_BK_ITEM_SEL</a>   | Background of a selected item.    |
| <a href="#">SWIPELIST_CI_BK_SEP_ITEM</a>   | Background of a separator item.   |

### 6.2.28.6.2.2 SWIPELIST bitmap alignment flags

#### Description

Flags to align the bitmaps of a SWIPELIST widget. These flags are used by the routine `SWIPELIST_SetBitmap()` and can be OR-combined.

#### Definition

```
#define SWIPELIST_BA_LEFT      (0 << 0)
#define SWIPELIST_BA_RIGHT    (1 << 0)
#define SWIPELIST_BA_HCENTER  (2 << 0)
#define SWIPELIST_BA_VCENTER  (3 << 2)
#define SWIPELIST_BA_TOP      (0 << 2)
#define SWIPELIST_BA_BOTTOM   (1 << 2)
```

#### Symbols

| Definition                        | Description  |
|-----------------------------------|--|
| Horizontal alignment              |  |
| <code>SWIPELIST_BA_HCENTER</code> | Center X-position.                                 |
| <code>SWIPELIST_BA_LEFT</code>    | Align X-position left (default).                   |
| <code>SWIPELIST_BA_RIGHT</code>   | Align X-position right.                            |
| Vertical alignment                |  |
| <code>SWIPELIST_BA_BOTTOM</code>  | Align Y-position with bottom pixel line of font.   |
| <code>SWIPELIST_BA_TOP</code>     | Align Y-position with top of characters (default). |
| <code>SWIPELIST_BA_VCENTER</code> | Center Y-position.                                 |

### 6.2.28.6.2.3 SWIPELIST border indexes

#### Description

Border indexes to e.g. change the border size of the SWIPELIST widget. A routine that uses these index flags is `SWIPELIST_SetBorderSize()`.

#### Definition

```
#define SWIPELIST_BI_LEFT      0
#define SWIPELIST_BI_RIGHT    1
#define SWIPELIST_BI_TOP      2
#define SWIPELIST_BI_BOTTOM   3
```

#### Symbols

| Definition                          | Description                 |
|-------------------------------------|-----------------------------|
| <a href="#">SWIPELIST_BI_LEFT</a>   | Left border of the items.   |
| <a href="#">SWIPELIST_BI_RIGHT</a>  | Right border of the items.  |
| <a href="#">SWIPELIST_BI_TOP</a>    | Top border of the items.    |
| <a href="#">SWIPELIST_BI_BOTTOM</a> | Bottom border of the items. |

#### 6.2.28.6.2.4 SWIPELIST font indexes

##### Description

Font indexes used for SWIPELIST routines.

##### Definition

```
#define SWIPELIST_FI_SEP_ITEM      0
#define SWIPELIST_FI_ITEM_HEADER  1
#define SWIPELIST_FI_ITEM_TEXT    2
```

##### Symbols

| Definition                               | Description                          |
|--|--------------------------------------|
| <a href="#">SWIPELIST_FI_SEP_ITEM</a>    | Font used by the separator item.     |
| <a href="#">SWIPELIST_FI_ITEM_HEADER</a> | Font used by the header of the item. |
| <a href="#">SWIPELIST_FI_ITEM_TEXT</a>   | Font used by the text of the item.   |

### 6.2.28.6.2.5 SWIPELIST item color indexes

#### Description

Color indexes used for SWIPELIST routines to return or set the color of an item.

#### Definition

```
#define SWIPELIST_CI_ITEM_HEADER_UNSEL    0
#define SWIPELIST_CI_ITEM_HEADER_SEL     1
#define SWIPELIST_CI_ITEM_TEXT_UNSEL     2
#define SWIPELIST_CI_ITEM_TEXT_SEL      3
#define SWIPELIST_CI_SEP_ITEM_TEXT      4
```

#### Symbols

| Definition                     | Description   |
|--------------------------------|---|
| SWIPELIST_CI_ITEM_HEADER_UNSEL | Color used for drawing the header text of an unselected item. |
| SWIPELIST_CI_ITEM_HEADER_SEL   | Color used for drawing the header text of a selected item.    |
| SWIPELIST_CI_ITEM_TEXT_UNSEL   | Color used for drawing the text for an unselected item.       |
| SWIPELIST_CI_ITEM_TEXT_SEL     | Color used for drawing the text of a selected item.           |
| SWIPELIST_CI_SEP_ITEM_TEXT     | Color used for drawing the text of a separator item.          |

### 6.2.28.6.2.6 SWIPELIST notification codes

#### Description

Notifications sent by SWIPELIST widget to its parent widget through a WM\_NOTIFY\_PARENT message.

For notifications relating overlap, see SWIPELIST\_SetOverlap().

#### Definition

```
#define SWIPELIST_NOTIFICATION_OVERLAP_TOP_ENTERED
    (WM_NOTIFICATION_WIDGET + 0)
#define SWIPELIST_NOTIFICATION_OVERLAP_BOTTOM_ENTERED
    (WM_NOTIFICATION_WIDGET + 1)
#define SWIPELIST_NOTIFICATION_OVERLAP_RELEASED
    (WM_NOTIFICATION_WIDGET + 2)
```

#### Symbols

| Definition                                    | Description  |
|---|--|
| SWIPELIST_NOTIFICATION_OVERLAP_TOP_ENTERED    | Sent when the overlap area was entered at the top of the SWIPELIST.    |
| SWIPELIST_NOTIFICATION_OVERLAP_BOTTOM_ENTERED | Sent when the overlap area was entered at the bottom of the SWIPELIST. |
| SWIPELIST_NOTIFICATION_OVERLAP_RELEASED       | Sent after a dragged overlap area has been released.                   |

## 6.2.28.7 Examples

The `Sample` folder contains the following example which shows how the widget can be used:

- `WIDGET_SwipeList.c`

### Screenshot of `WIDGET_SwipeList.c`

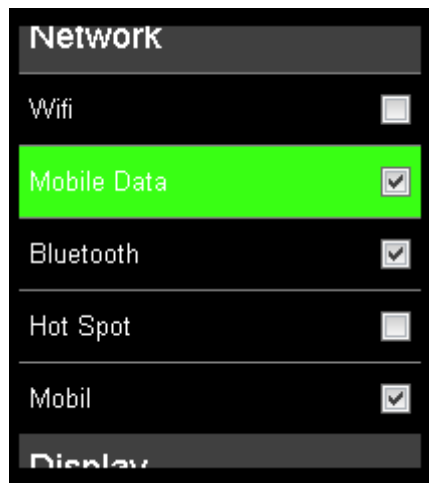



## 6.2.29 SWITCH: Switch widget

A SWITCH widget is a toggleable switch with two states. The widget is similar to the switches seen on most modern smartphones, e.g. in a phone settings application. A SWITCH widget can have two states, a 'left' state when the thumb is on the left and a 'right' state when the thumb is on the right. Optionally, each state has its own text that is shown inside of the switch.

The widget can be clicked to be toggled, or its thumb can be dragged from one side along to the other side, as seen on most smartphones. To be able to drag the thumb, motion support has to be enabled by calling `WM_MOTION_Enable(1)`.



### Note

All SWITCH-related routines are located in the file(s) `SWITCH*.c`, `SWITCH.h`. All identifiers are prefixed `SWITCH`. Memory Devices are required to use the SWITCH widget.

### 6.2.29.1 Configuration options

| Type | Macro                                  | Default                | Description                                 |
|------|--|------------------------|---|
| N    | <code>SWITCH_COLORLEFT_DEFAULT</code>  | <code>GUI_BLACK</code> | Text color for text shown in 'left' state.  |
| N    | <code>SWITCH_COLORRIGHT_DEFAULT</code> | <code>GUI_BLACK</code> | Text color for text shown in 'right' state. |
| N    | <code>SWITCH_PERIOD_DEFAULT</code>     | 80                     | Animation period for a toggle operation.    |

### 6.2.29.2 Predefined IDs

The following symbols define IDs which may be used to make SWITCH widgets distinguishable from creation.

```
#define GUI_ID_SWITCH0    0x330
#define GUI_ID_SWITCH1    0x331
#define GUI_ID_SWITCH2    0x332
#define GUI_ID_SWITCH3    0x333
#define GUI_ID_SWITCH4    0x334
#define GUI_ID_SWITCH5    0x335
#define GUI_ID_SWITCH6    0x336
#define GUI_ID_SWITCH7    0x337
#define GUI_ID_SWITCH8    0x338
#define GUI_ID_SWITCH9    0x339
```

### 6.2.29.3 Notification codes

The following events are sent from a SWITCH widget to its parent window as part of a `WM_NOTIFY_PARENT` message:

| Message                               | Description               |
|---------------------------------------|---------------------------|
| <code>WM_NOTIFICATION_CLICKED</code>  | SWITCH has been clicked.  |
| <code>WM_NOTIFICATION_RELEASED</code> | SWITCH has been released. |

| Message                       | Description  |
|-------------------------------|--|
| WM_NOTIFICATION_MOVED_OUT     | SWITCH has been clicked and pointer has been moved out of the SWITCH area without releasing. |
| WM_NOTIFICATION_VALUE_CHANGED | The state of the SWITCH widget has been changed.   |

## 6.2.29.4 SWITCH API

The table below lists the available SWITCH-related routines in alphabetical order. Detailed descriptions of the routines follow.

### Functions

| Routine                                   | Description   |
|---|---|
| <code>SWITCH_AnimState()</code>           | Sets the SWITCH widget to the desired state and shows the toggle animation. |
| <code>SWITCH_CreateIndirect()</code>      | Creates a SWITCH widget from a resource table entry.                        |
| <code>SWITCH_CreateUser()</code>          | Creates a SWITCH widget.  |
| <code>SWITCH_DisableAnimation()</code>    | Option for disabling the animation of a SWITCH when clicking the widget.    |
| <code>SWITCH_GetDefaultFont()</code>      | Returns the default font for SWITCH widgets.                                |
| <code>SWITCH_GetDefaultPeriod()</code>    | Returns the default period for SWITCH widgets.                              |
| <code>SWITCH_GetDefaultTextColor()</code> | Returns the default text color for SWITCH widgets.                          |
| <code>SWITCH_GetState()</code>            | Returns the state of a SWITCH widget.                                       |
| <code>SWITCH_GetUserData()</code>         | Retrieves the extra data set with <code>SWITCH_SetUserData()</code> .       |
| <code>SWITCH_SetBitmap()</code>           | Sets a bitmap for a state of the SWITCH widget.                             |
| <code>SWITCH_SetDefaultFont()</code>      | Sets the default font for SWITCH widgets.                                   |
| <code>SWITCH_SetDefaultPeriod()</code>    | Sets the default period for SWITCH widgets.                                 |
| <code>SWITCH_SetDefaultTextColor()</code> | Sets the default text color for SWITCH widgets.                             |
| <code>SWITCH_SetFont()</code>             | Sets the font of a SWITCH widget.   |
| <code>SWITCH_SetMode()</code>             | Sets the mode of a SWITCH widget.   |
| <code>SWITCH_SetPeriod()</code>           | Sets the period to stop the animation of a SWITCH widget.                   |
| <code>SWITCH_SetState()</code>            | Sets the state of a SWITCH widget.  |
| <code>SWITCH_SetText()</code>             | Sets a text on either the left or right side of the SWITCH widget.          |
| <code>SWITCH_SetTextColor()</code>        | Sets the text color of a SWITCH widget.                                     |
| <code>SWITCH_SetUserData()</code>         | Sets the extra data of a SWITCH widget.                                     |
| <code>SWITCH_Toggle()</code>              | Toggles the state of a SWITCH widget.                                       |

### Defines

| Group of defines                   | Description                               |
|------------------------------------|---|
| <code>SWITCH_bitmap_indexes</code> | Bitmap indexes used by the SWITCH widget. |
| <code>SWITCH_color_indexes</code>  | Color indexes used by the SWITCH widget.  |
| <code>SWITCH_modes</code>          | Modes a SWITCH widget can be set to.      |
| <code>SWITCH_text_indexes</code>   | Text indexes used by the SWITCH widget.   |

| Group of defines           | Description                                |
|----------------------------|--|
| <code>SWITCH states</code> | Possible states a SWITCH widget can be in. |

## 6.2.29.4.1 Functions

### 6.2.29.4.1.1 SWITCH\_AnimState()

#### Description

Sets the SWITCH widget to the desired state and shows the toggle animation.

#### Prototype

```
void SWITCH_AnimState(SWITCH_Handle hObj,  
                      int             State);
```

#### Parameters

| Parameter             | Description                |
|-----------------------|----------------------------|
| <a href="#">hObj</a>  | Handle of a SWITCH widget. |
| <a href="#">State</a> | See table below.           |

### 6.2.29.4.1.2 SWITCH\_CreateIndirect()

#### Description

The prototype of this function is explained at the beginning of this chapter. Details can be found in the description of the function `<WIDGET>_CreateIndirect()` on page 992.

### 6.2.29.4.1.3 SWITCH\_CreateUser()

#### Description

Creates a SWITCH widget.

#### Prototype

```
SWITCH_Handle SWITCH_CreateUser(int    x0,
                                int    y0,
                                int    xSize,
                                int    ySize,
                                WM_HWIN hParent,
                                int    WinFlags,
                                int    ExFlags,
                                int    Id,
                                int    NumExtraBytes);
```

#### Parameters

| Parameter                  | Description  |
|----------------------------|--|
| <code>x0</code>            | Leftmost pixel of the SWITCH widget (in parent coordinates).   |
| <code>y0</code>            | Topmost pixel of the SWITCH widget (in parent coordinates).  |
| <code>xSize</code>         | Horizontal size of the SWITCH widget (in pixels).  |
| <code>ySize</code>         | Vertical size of the SWITCH widget (in pixels).  |
| <code>hParent</code>       | Parent window of the SWITCH widget.  |
| <code>WinFlags</code>      | Window create flags. Typically <code>WM_CF_SHOW</code> in order to make the widget visible immediately (refer to <i>Window create flags</i> on page 977 for a list of available parameter values). |
| <code>ExFlags</code>       | Not used yet, reserved for future use.   |
| <code>Id</code>            | ID of the SWITCH widget.   |
| <code>NumExtraBytes</code> | Number of extra bytes to be allocated.   |

#### Return value

Handle of the SWITCH widget.

#### 6.2.29.4.1.4 SWITCH\_DisableAnimation()

##### Description

Option for disabling the animation of a SWITCH when clicking the widget.

##### Prototype

```
void SWITCH_DisableAnimation(SWITCH_Handle hObj,  
                             U8           Disable);
```

##### Parameters

| Parameter            | Description  |
|----------------------|--|
| <code>hObj</code>    | Handle of a SWITCH widget.                                       |
| <code>Disable</code> | 1 for disabling animations, 0 for enabling animations (default). |

#### 6.2.29.4.1.5 SWITCH\_GetDefaultFont()

##### Description

Returns the default font for SWITCH widgets.

##### Prototype

```
GUI_FONT *SWITCH_GetDefaultFont(void);
```

##### Return value

Default font for SWITCH widgets.



#### 6.2.29.4.1.6 SWITCH\_GetDefaultPeriod()

##### Description

Returns the default period for SWITCH widgets. This is the duration of the animation when the SWITCH widget is clicked.

##### Prototype

```
unsigned SWITCH_GetDefaultPeriod(void);
```

##### Return value

Default period for SWITCH widgets.

### 6.2.29.4.1.7 SWITCH\_GetDefaultTextColor()

#### Description

Returns the default text color for SWITCH widgets.

#### Prototype

```
GUI_COLOR SWITCH_GetDefaultTextColor(unsigned Index);
```

#### Parameters

| Parameter             | Description  |
|-----------------------|--|
| <a href="#">Index</a> | Text index. See <i>SWITCH text indexes</i> on page 2192. |

#### Return value

Default text color for SWITCH widgets.

### 6.2.29.4.1.8 SWITCH\_GetState()

#### Description

Returns the state of a SWITCH widget.

#### Prototype

```
int SWITCH_GetState(SWITCH_Handle hObj);
```

#### Parameters

| Parameter            | Description                |
|----------------------|----------------------------|
| <a href="#">hObj</a> | Handle of a SWITCH widget. |

#### Return value

|                    |                |
|--------------------|----------------|
| -1                 | Invalid state. |
| SWITCH_STATE_RIGHT | 'Right' state. |
| SWITCH_STATE_LEFT  | 'Left' state.  |

### 6.2.29.4.1.9 SWITCH\_GetUserData()

#### Description

Prototype explained at the beginning of the chapter as `<WIDGET>_GetUserData()` on page 994.

### 6.2.29.4.1.10 SWITCH\_SetBitmap()

#### Description

Sets a bitmap for a state of the SWITCH widget.

#### Prototype

```
void SWITCH_SetBitmap(    SWITCH_Handle  hObj,  
                        unsigned int   Index,  
                        const GUI_BITMAP * pBitmap);
```

#### Parameters

| Parameter               | Description                                    |
|-------------------------|--|
| <a href="#">hObj</a>    | Handle of a SWITCH widget.                     |
| <a href="#">Index</a>   | See <i>SWITCH bitmap indexes</i> on page 2189. |
| <a href="#">pBitmap</a> | Pointer to a bitmap.                           |

### 6.2.29.4.1.11 SWITCH\_SetDefaultFont()

#### Description

Sets the default font for SWITCH widgets.

#### Prototype

```
void SWITCH_SetDefaultFont(const GUI_FONT * pFont);
```

#### Parameters

| Parameter          | Description                  |
|--------------------|------------------------------|
| <code>pFont</code> | Pointer to a font to be set. |

#### 6.2.29.4.1.12 SWITCH\_SetDefaultPeriod()

##### Description

Sets the default period for SWITCH widgets.

##### Prototype

```
void SWITCH_SetDefaultPeriod(unsigned Period);
```

##### Parameters

| Parameter           | Description                    |
|---------------------|--------------------------------|
| <code>Period</code> | <code>Period</code> to be set. |

### 6.2.29.4.1.13 SWITCH\_SetDefaultTextColor()

#### Description

Sets the default text color for SWITCH widgets.

#### Prototype

```
void SWITCH_SetDefaultTextColor(GUI_COLOR Color,  
                               unsigned Index);
```

#### Parameters

| Parameter | Description  |
|-----------|--|
| Color     | Color to be set.   |
| Index     | Color index. See <i>SWITCH color indexes</i> on page 2190. |



#### 6.2.29.4.1.14 SWITCH\_SetFont()



#### Description

Sets the font of a SWITCH widget.

#### Prototype

```
void SWITCH_SetFont(    SWITCH_Handle  hObj,
                      const GUI_FONT  * pFont);
```

#### Parameters

| Parameter | Description                |
|-----------|----------------------------|
| hObj      | Handle of a SWITCH widget. |
| pFont     | Pointer to a GUI_FONT.     |

### 6.2.29.4.1.15 SWITCH\_SetMode()

#### Description

Sets the mode of a SWITCH widget. The mode can be set to either disclose mode (default) or fade mode.

#### Prototype

```
void SWITCH_SetMode(SWITCH_Handle hObj,  
                    int           Mode);
```

#### Parameters

| Parameter            | Description                           |
|----------------------|---------------------------------------|
| <a href="#">hObj</a> | Handle of a SWITCH widget.            |
| <a href="#">Mode</a> | See <i>SWITCH modes</i> on page 2191. |

#### Disclose mode

In disclose mode the bitmap of the new state is disclosed while the old state bitmap disappears under the thumb.



#### Fade mode

In fade mode both state bitmaps are faded into each other.



#### 6.2.29.4.1.16 SWITCH\_SetPeriod()

##### Description

Sets the period to stop the animation of a SWITCH widget.

##### Prototype

```
void SWITCH_SetPeriod(SWITCH_Handle hObj,  
                      I32           Period);
```

##### Parameters

| Parameter           | Description                             |
|---------------------|---|
| <code>hObj</code>   | Handle of a SWITCH widget.              |
| <code>Period</code> | Animation period. Maximum value: 46340. |

#### 6.2.29.4.1.17 SWITCH\_SetState()

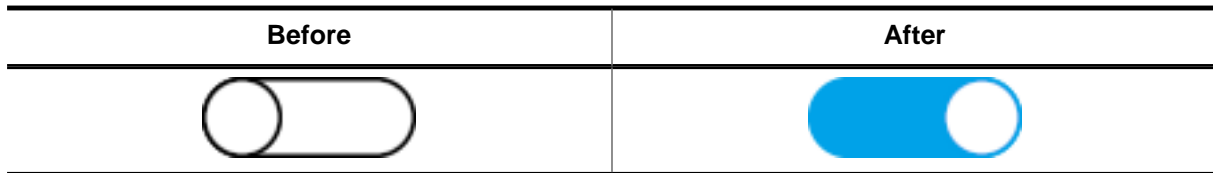

#### Description

Sets the state of a SWITCH widget.

#### Prototype

```
void SWITCH_SetState(SWITCH_Handle hObj,  
                    int State);
```

#### Parameters

| Parameter          | Description                            |
|--------------------|--|
| <code>hObj</code>  | Handle of a SWITCH widget.             |
| <code>State</code> | See <i>SWITCH states</i> on page 2193. |

### 6.2.29.4.1.18 SWITCH\_SetText()

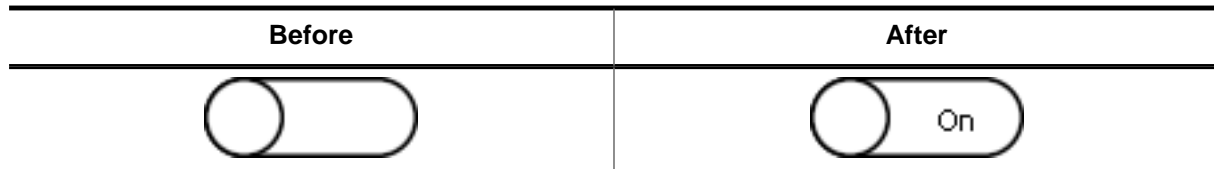

#### Description

Sets a text on either the left or right side of the SWITCH widget.

#### Prototype

```
int SWITCH_SetText(    SWITCH_Handle  hObj,
                     unsigned int    Index,
                     const char      * pText);
```

#### Parameters

| Parameter             | Description  |
|-----------------------|--|
| <a href="#">hObj</a>  | Handle of a SWITCH widget.                               |
| <a href="#">Index</a> | Text index. See <i>SWITCH text indexes</i> on page 2192. |
| <a href="#">pText</a> | Pointer to a string.                                     |

#### Return value

- 0      If the routine succeeded.
- 1      If the routine failed.

### 6.2.29.4.1.19 SWITCH\_SetTextColor()

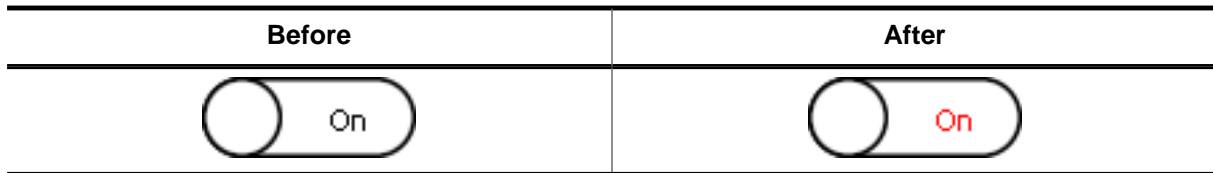

#### Description

Sets the text color of a SWITCH widget.

#### Prototype

```
void SWITCH_SetTextColor(SWITCH_Handle hObj,
                        unsigned int  Index,
                        GUI_COLOR     Color);
```

#### Parameters

| Parameter          | Description   |
|--------------------|---|
| <code>hObj</code>  | Handle of a SWITCH widget.  |
| <code>Index</code> | See <i>SWITCH color indexes</i> on page 2190 for a full list of permitted values. |
| <code>Color</code> | <code>Color</code> to be used.  |

#### 6.2.29.4.1.20 SWITCH\_SetUserData()

##### Description

Prototype explained at the beginning of the chapter as `<WIDGET>_SetUserData()` on page 995.

#### 6.2.29.4.1.21 SWITCH\_Toggle()

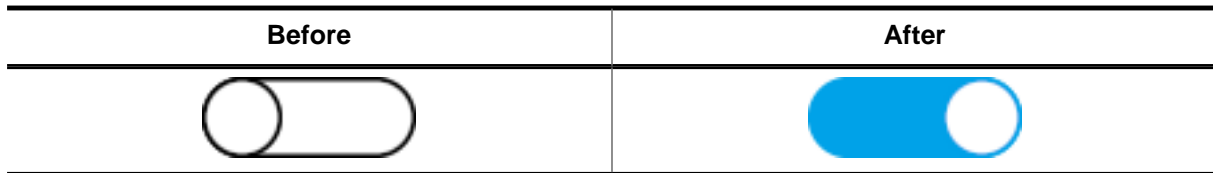

#### Description

Toggles the state of a SWITCH widget.

#### Prototype

```
void SWITCH_Toggle(SWITCH_Handle hObj);
```

#### Parameters

| Parameter            | Description                |
|----------------------|----------------------------|
| <a href="#">hObj</a> | Handle of a SWITCH widget. |



## 6.2.29.4.2 Defines

### 6.2.29.4.2.1 SWITCH bitmap indexes

#### Description

Bitmap indexes used by the SWITCH widget for handling bitmaps.

#### Definition

```
#define SWITCH_BI_BK_LEFT          0
#define SWITCH_BI_BK_RIGHT        1
#define SWITCH_BI_BK_DISABLED     2
#define SWITCH_BI_THUMB_LEFT      3
#define SWITCH_BI_THUMB_RIGHT     4
#define SWITCH_BI_THUMB_DISABLED  5
```

#### Symbols

| Definition                               | Description                           |
|--|---------------------------------------|
| <a href="#">SWITCH_BI_BK_LEFT</a>        | Background bitmap for left state.     |
| <a href="#">SWITCH_BI_BK_RIGHT</a>       | Background bitmap for right state.    |
| <a href="#">SWITCH_BI_BK_DISABLED</a>    | Background bitmap for disabled state. |
| <a href="#">SWITCH_BI_THUMB_LEFT</a>     | Thumb bitmap for left state.          |
| <a href="#">SWITCH_BI_THUMB_RIGHT</a>    | Thumb bitmap for right state.         |
| <a href="#">SWITCH_BI_THUMB_DISABLED</a> | Thumb bitmap for disabled state.      |

### 6.2.29.4.2.2 SWITCH color indexes

#### Description

Color indexes used by the SWITCH widget.

#### Definition

```
#define SWITCH_CI_LEFT      0
#define SWITCH_CI_RIGHT    1
#define SWITCH_CI_DISABLED 2
```

#### Symbols

| Definition                         | Description               |
|------------------------------------|---------------------------|
| <a href="#">SWITCH_CI_LEFT</a>     | Color for left state.     |
| <a href="#">SWITCH_CI_RIGHT</a>    | Color for right state.    |
| <a href="#">SWITCH_CI_DISABLED</a> | Color for disabled state. |

### 6.2.29.4.2.3 SWITCH modes

#### Description

Modes a SWITCH widget can be set to. See `SWITCH_SetMode()` for more information.

#### Definition

```
#define SWITCH_MODE_FADE      (1 << 0)
#define SWITCH_MODE_DISCLOSE (1 << 1)
```

#### Symbols

| Definition                           | Description  |
|--------------------------------------|--|
| <a href="#">SWITCH_MODE_FADE</a>     | Fade mode. Both state bitmaps are faded into each other. |
| <a href="#">SWITCH_MODE_DISCLOSE</a> | Disclose mode. Bitmap of the new state is disclosed.     |

#### 6.2.29.4.2.4 SWITCH text indexes

##### Description

Text indexes used by the SWITCH widget.

##### Definition

```
#define SWITCH_TI_LEFT    0
#define SWITCH_TI_RIGHT  1
```

##### Symbols

| Definition      | Description                     |
|-----------------|---------------------------------|
| SWITCH_TI_LEFT  | Text shown for the left state.  |
| SWITCH_TI_RIGHT | Text shown for the right state. |

### 6.2.29.4.2.5 SWITCH states

#### Description

List of defines of the possible states a SWITCH widget can be in.

#### Definition

```
#define SWITCH_STATE_LEFT    0
#define SWITCH_STATE_RIGHT  1
```

#### Symbols

| Definition                         | Description  |
|------------------------------------|--|
| <a href="#">SWITCH_STATE_LEFT</a>  | Left state, the thumb is on the left side of the widget.   |
| <a href="#">SWITCH_STATE_RIGHT</a> | Right state, the thumb is on the right side of the widget. |

## 6.2.30 TEXT: Text widget

Text widgets are typically used in order to display fields of text in dialog boxes, as shown in the message box below:



Of course, text fields may also be used for labeling other widgets, as follows:

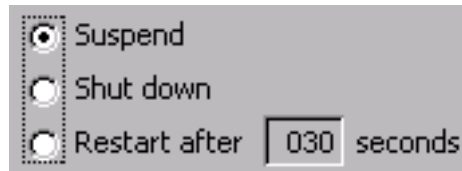

### Note

All TEXT-related routines are located in the file(s) `TEXT*.c`, `TEXT.h`. All identifiers are prefixed `TEXT`.

### 6.2.30.1 Configuration options

| Type | Macro                                | Default                        | Description                         |
|------|--------------------------------------|--------------------------------|-------------------------------------|
| N    | <code>TEXT_DEFAULT_BK_COLOR</code>   | <code>GUI_INVALID_COLOR</code> | Transparent background per default. |
| S    | <code>TEXT_DEFAULT_ROTATION</code>   | <code>GUI_ROTATION_0</code>    | Default text rotation.              |
| N    | <code>TEXT_DEFAULT_TEXT_COLOR</code> | <code>GUI_BLACK</code>         | Default text color.                 |
| N    | <code>TEXT_DEFAULT_WRAPMODE</code>   | <code>GUI_WRAPMODE_NONE</code> | Default wrapping mode.              |
| S    | <code>TEXT_FONT_DEFAULT</code>       | <code>&amp;GUI_Font13_1</code> | Font used.                          |

### 6.2.30.2 Predefined IDs

The following symbols define IDs which may be used to make TEXT widgets distinguishable from creation.

```
#define GUI_ID_TEXT0    0x160
#define GUI_ID_TEXT1    0x161
#define GUI_ID_TEXT2    0x162
#define GUI_ID_TEXT3    0x163
#define GUI_ID_TEXT4    0x164
#define GUI_ID_TEXT5    0x165
#define GUI_ID_TEXT6    0x166
#define GUI_ID_TEXT7    0x167
#define GUI_ID_TEXT8    0x168
#define GUI_ID_TEXT9    0x169
```

### 6.2.30.3 Notification codes

The following events are sent from a TEXT widget to its parent window as part of a WM\_NOTIFY\_PARENT message:

| Message                   | Description  |
|---------------------------|--|
| WM_NOTIFICATION_CLICKED   | The widget has been clicked.   |
| WM_NOTIFICATION_RELEASED  | The widget has been released.  |
| WM_NOTIFICATION_MOVED_OUT | The pointer was moved out of the widget area while the PID was in pressed state. |

### 6.2.30.4 Keyboard reaction

The widget can not gain the input focus and does not react on keyboard input.

### 6.2.30.5 TEXT API

The table below lists the available emWin TEXT-related routines in alphabetical order. Detailed descriptions of the routines follow.

#### Functions

| Routine                                  | Description  |
|--|--|
| <code>TEXT_Create()</code>               | Creates a TEXT widget. (Obsolete)  |
| <code>TEXT_CreateAsChild()</code>        | Creates a TEXT widget as a child window. (Obsolete)  |
| <code>TEXT_CreateEx()</code>             | Creates a TEXT widget.   |
| <code>TEXT_CreateIndirect()</code>       | Creates a TEXT widget from resource table entry.   |
| <code>TEXT_CreateUser()</code>           | Creates a TEXT widget using extra bytes as user data.  |
| <code>TEXT_GetBkColor()</code>           | Returns the current background color.  |
| <code>TEXT_GetDefaultFont()</code>       | Returns the default font used for TEXT widgets.  |
| <code>TEXT_GetDefaultFrameColor()</code> | Returns the default frame color used for framed fonts.   |
| <code>TEXT_GetDefaultRotation()</code>   | Returns the default text rotation mode.  |
| <code>TEXT_GetDefaultTextColor()</code>  | Returns the default text color.  |
| <code>TEXT_GetDefaultWrapMode()</code>   | Returns the default mode for wrapping text used for TEXT widget. Returns the default mode for wrapping text.                         |
| <code>TEXT_GetFont()</code>              | Returns a pointer to the font used to display the text of the given TEXT widget. Returns the pointer to the font of the TEXT widget. |
| <code>TEXT_GetFrameColor()</code>        | Returns the frame color used for framed fonts of the given TEXT widget.  |
| <code>TEXT_GetNumLines()</code>          | Returns the number of lines currently displayed in the widget.   |
| <code>TEXT_GetRotation()</code>          | Returns the text rotation of a TEXT widget.  |
| <code>TEXT_GetText()</code>              | Copies the text of the given TEXT widget to the given buffer.  |
| <code>TEXT_GetTextAlign()</code>         | Returns the alignment of the given TEXT widget.  |
| <code>TEXT_GetTextColor()</code>         | Returns the text color of the given TEXT widget.   |
| <code>TEXT_GetTextOffset()</code>        | Returns the offset set for X and Y position of the text.   |

| Routine                                  | Description  |
|--|--|
| <code>TEXT_GetUserData()</code>          | Retrieves the data set with <code>TEXT_SetUserData()</code> .  |
| <code>TEXT_GetWrapMode()</code>          | Returns the currently used mode for wrapping text of the given TEXT widget. Returns the currently used mode for wrapping text. |
| <code>TEXT_SetBkColor()</code>           | Sets the background color of the TEXT widget. Sets the background color for the text.  |
| <code>TEXT_SetDec()</code>               | This function sets a value which gets displayed by the TEXT widget in decimal mode. Sets a value to be displayed.              |
| <code>TEXT_SetDefaultFont()</code>       | Sets the default font used for TEXT widgets.   |
| <code>TEXT_SetDefaultFrameColor()</code> | Sets the default frame color used for framed fonts.  |
| <code>TEXT_SetDefaultRotation()</code>   | Sets the default rotation mode for new TEXT widgets.   |
| <code>TEXT_SetDefaultTextColor()</code>  | Sets the default text color used for TEXT widgets.   |
| <code>TEXT_SetDefaultWrapMode()</code>   | Sets the default text wrapping mode used for new TEXT widgets.   |
| <code>TEXT_SetFont()</code>              | Sets the font to be used for a specified TEXT widget.  |
| <code>TEXT_SetFrameColor()</code>        | Sets the frame color for fonts of a specified TEXT widget.   |
| <code>TEXT_SetRotation()</code>          | Sets the text rotation for a TEXT widget.  |
| <code>TEXT_SetText()</code>              | Sets the text to be used for a specified TEXT widget.  |
| <code>TEXT_SetTextAlign()</code>         | Sets the text alignment of a specified TEXT widget.  |
| <code>TEXT_SetTextColor()</code>         | Sets the text color of a specified TEXT widget.  |
| <code>TEXT_SetTextOffset()</code>        | Sets an X- and Y-offset for the text of a TEXT widget.   |
| <code>TEXT_SetUserData()</code>          | Sets the extra data of a TEXT widget.  |
| <code>TEXT_SetWrapMode()</code>          | Sets the wrapping mode of a specified TEXT widget.   |

## Defines

| Group of defines               | Description                           |
|--------------------------------|---------------------------------------|
| <code>TEXT create flags</code> | Create flags used by the TEXT widget. |



## 6.2.30.5.1 Functions

### 6.2.30.5.1.1 TEXT\_Create()

#### Note

This function is **deprecated**, `TEXT_CreateEx()` should be used instead.

#### Description

Creates a TEXT widget of a specified size at a specified location.

#### Prototype

```
TEXT_Handle TEXT_Create(      int    x0,
                             int    y0,
                             int    xSize,
                             int    ySize,
                             int    Id,
                             int    Flags,
                             const char * s,
                             int    Align);
```

#### Parameters

| Parameter          | Description  |
|--------------------|--|
| <code>x0</code>    | Leftmost pixel of the TEXT widget (in parent coordinates).   |
| <code>y0</code>    | Topmost pixel of the TEXT widget (in parent coordinates).  |
| <code>xSize</code> | Horizontal size of the TEXT widget (in pixels).  |
| <code>ySize</code> | Vertical size of the TEXT widget (in pixels).  |
| <code>Id</code>    | ID to be returned.   |
| <code>Flags</code> | Window create flags. Typically <code>WM_CF_SHOW</code> in order to make the widget visible immediately (refer to <i>Window create flags</i> on page 977 for a list of available parameter values). |
| <code>s</code>     | Pointer to the text to be displayed.   |
| <code>Align</code> | Alignment attribute for the text. See <i>TEXT create flags</i> on page 2234.   |

#### Return value

Handle of the created TEXT widget; 0 if the function fails.

### 6.2.30.5.1.2 TEXT\_CreateAsChild()

#### Note

This function is **deprecated**, `TEXT_CreateEx()` should be used instead.

#### Description

Creates a TEXT widget as a child window.

#### Prototype

```
TEXT_Handle TEXT_CreateAsChild(    int    x0,
                                   int    y0,
                                   int    xSize,
                                   int    ySize,
                                   WM_HWIN hParent,
                                   int    Id,
                                   int    Flags,
                                   const char * s,
                                   int    Align);
```

#### Parameters

| Parameter            | Description   |
|----------------------|---|
| <code>x0</code>      | X-position of the PROGBAR widget relative to the parent window.   |
| <code>y0</code>      | Y-position of the PROGBAR widget relative to the parent window.   |
| <code>xSize</code>   | Horizontal size of the TEXT widget (in pixels).                   |
| <code>ySize</code>   | Vertical size of the TEXT widget (in pixels).                     |
| <code>hParent</code> | Handle of parent window.  |
| <code>Id</code>      | ID to be returned.  |
| <code>Flags</code>   | Window create flags (see <i>Window create flags</i> on page 977). |
| <code>s</code>       | Pointer to the text to be displayed.                              |
| <code>Align</code>   | Alignment attribute. See <i>TEXT create flags</i> on page 2234.   |

#### Return value

Handle of the created TEXT widget; 0 if the function fails.

### 6.2.30.5.1.3 TEXT\_CreateEx()

#### Description

Creates a TEXT widget of a specified size at a specified location.

#### Prototype

```
TEXT_Handle TEXT_CreateEx(    int        x0,
                             int        y0,
                             int        xSize,
                             int        ySize,
                             WM_HWIN   hParent,
                             int        WinFlags,
                             int        ExFlags,
                             int        Id,
                             const char * pText);
```

#### Parameters

| Parameter             | Description  |
|-----------------------|--|
| <code>x0</code>       | Leftmost pixel of the widget (in parent coordinates).  |
| <code>y0</code>       | Topmost pixel of the widget (in parent coordinates).   |
| <code>xSize</code>    | Horizontal size of the widget (in pixels).   |
| <code>ySize</code>    | Vertical size of the widget (in pixels).   |
| <code>hParent</code>  | Handle of parent window. If 0, the new TEXT widget will be a child of the desktop (top-level window).  |
| <code>WinFlags</code> | Window create flags. Typically <code>WM_CF_SHOW</code> in order to make the widget visible immediately (refer to <i>Window create flags</i> on page 977 for a list of available parameter values). |
| <code>ExFlags</code>  | Alignment attribute for the text. See <i>TEXT create flags</i> on page 2234.   |
| <code>Id</code>       | Window ID of the TEXT widget.  |
| <code>pText</code>    | Pointer to the text to be displayed.   |

#### Return value

Handle of the created TEXT widget; 0 if the function fails.

#### 6.2.30.5.1.4 TEXT\_CreateIndirect()

##### Description

The prototype of this function is explained at the beginning of this chapter. Details can be found in the description of the function `<WIDGET>_CreateIndirect()` on page 992. The element `Para` of the according `GUI_WIDGET_CREATE_INFO` structure is not used. The element `Flags` is used according to the parameter `ExFlags` of the function `TEXT_CreateEx()`.

### 6.2.30.5.1.5 TEXT\_CreateUser()

#### Description

Prototype explained at the beginning of the chapter as `<WIDGET>_CreateUser()` on page 993. For a detailed description of the parameters the function `TEXT_CreateEx()` can be referred to.

### 6.2.30.5.1.6 TEXT\_GetBkColor()

#### Description

Returns the current background color of the given TEXT widget.

#### Prototype

```
GUI_COLOR TEXT_GetBkColor(TEXT_Handle hObj);
```

#### Parameters

| Parameter            | Description            |
|----------------------|------------------------|
| <a href="#">hObj</a> | Handle of TEXT widget. |

#### Return value

The current background color.

### 6.2.30.5.1.7 TEXT\_GetDefaultFont()

#### Description

Returns the default font used for TEXT widgets.

#### Prototype

```
GUI_FONT *TEXT_GetDefaultFont(void);
```

#### Return value

Pointer to the default font used for TEXT widgets.

### 6.2.30.5.1.8 TEXT\_GetDefaultFrameColor()

#### Description

Returns the default frame color used for framed fonts.

#### Prototype

```
GUI_COLOR TEXT_GetDefaultFrameColor(void);
```

#### Return value

Default frame color.



### 6.2.30.5.1.9 TEXT\_GetDefaultRotation()

#### Description

Returns the default text rotation mode.

#### Prototype

```
GUI_ROTATION *TEXT_GetDefaultRotation(void);
```

#### Return value

Default text rotation mode.

#### Additional information

Refer to *Text rotation modes* on page 254 for a list of possible values.

### 6.2.30.5.1.10 TEXT\_GetDefaultTextColor()

#### Description

Returns the default text color used for TEXT widgets.

#### Prototype

```
GUI_COLOR TEXT_GetDefaultTextColor(void);
```

#### Return value

Default text color.

### 6.2.30.5.1.11 TEXT\_GetDefaultWrapMode()

#### Description

Returns the default mode for wrapping text used for TEXT widget.

#### Prototype

```
GUI_WRAPMODE TEXT_GetDefaultWrapMode(void);
```

#### Return value

Default wrap mode.

### 6.2.30.5.1.12 TEXT\_GetFont()

#### Description

Returns a pointer to the font used to display the text of the given TEXT widget.

#### Prototype

```
GUI_FONT *TEXT_GetFont(TEXT_Handle hObj);
```

#### Parameters

| Parameter            | Description            |
|----------------------|------------------------|
| <a href="#">hObj</a> | Handle of TEXT widget. |

#### Return value

Pointer to the font used to display the text of the given TEXT widget.

### 6.2.30.5.1.13 TEXT\_GetFrameColor()

#### Description

Returns the frame color used for framed fonts of the given TEXT widget.

#### Prototype

```
GUI_COLOR TEXT_GetFrameColor(TEXT_Handle hObj);
```

#### Parameters

| Parameter            | Description                |
|----------------------|----------------------------|
| <a href="#">hObj</a> | Handle of the TEXT widget. |

#### Return value

Frame color of the given TEXT widget.

#### 6.2.30.5.1.14 TEXT\_GetNumLines()

##### Description

Returns the number of lines currently displayed in the widget.

##### Prototype

```
int TEXT_GetNumLines(TEXT_Handle hObj);
```

##### Parameters

| Parameter            | Description            |
|----------------------|------------------------|
| <a href="#">hObj</a> | Handle of TEXT widget. |

##### Return value

Number of lines.

### 6.2.30.5.1.15 TEXT\_GetRotation()

#### Description

Returns the text rotation of a TEXT widget.

#### Prototype

```
GUI_ROTATION *TEXT_GetRotation(TEXT_Handle hObj);
```

#### Parameters

| Parameter            | Description            |
|----------------------|------------------------|
| <a href="#">hObj</a> | Handle of TEXT widget. |

#### Return value

|                |                                    |
|----------------|------------------------------------|
| GUI_ROTATE_0   | Text is not rotated.               |
| GUI_ROTATE_CW  | Text is rotated clockwise.         |
| GUI_ROTATE_180 | Text is rotated by 180 degrees.    |
| GUI_ROTATE_CCW | Text is rotated counter-clockwise. |
| -1             | On error.                          |

#### Additional information

To learn more about rotating text in emWin, refer to `GUI_DispStringInRectEx()`.

### 6.2.30.5.1.16 TEXT\_GetText()

#### Description

Copies the text of the given TEXT widget to the given buffer. The 0-Byte at the end of the string is written in any case.

#### Prototype

```
int TEXT_GetText(TEXT_Handle hObj,  
                char * pDest,  
                U32 BufferSize);
```

#### Parameters

| Parameter               | Description                       |
|-------------------------|-----------------------------------|
| <code>hObj</code>       | Handle of the TEXT widget.        |
| <code>pDest</code>      | Pointer to a user defined buffer. |
| <code>BufferSize</code> | Size of the buffer.               |

#### Return value

Number of bytes copied.



### 6.2.30.5.1.17 TEXT\_GetTextAlign()

#### Description

Returns the alignment of the given TEXT widget.

#### Prototype

```
int TEXT_GetTextAlign(TEXT_Handle hObj);
```

#### Parameters

| Parameter            | Description                |
|----------------------|----------------------------|
| <a href="#">hObj</a> | Handle of the TEXT widget. |

#### Return value

Alignment of the text.

### 6.2.30.5.1.18 TEXT\_GetTextColor()

#### Description

Returns the text color of the given TEXT widget.

#### Prototype

```
GUI_COLOR TEXT_GetTextColor(TEXT_Handle hObj);
```

#### Parameters

| Parameter            | Description                |
|----------------------|----------------------------|
| <a href="#">hObj</a> | Handle of the TEXT widget. |

#### Return value

Text color of the given TEXT widget.

### 6.2.30.5.1.19 TEXT\_GetTextOffset()

#### Description

Returns the offset set for X and Y position of the text.

#### Prototype

```
void TEXT_GetTextOffset(TEXT_Handle hObj,  
                        int * pxPos,  
                        int * pyPos);
```

#### Parameters

| Parameter             | Description  |
|-----------------------|--|
| <a href="#">hObj</a>  | Handle of TEXT widget.                             |
| <a href="#">pxPos</a> | Pointer to an int to store the X-offset in pixels. |
| <a href="#">pyPos</a> | Pointer to an int to store the Y-offset in pixels. |

### 6.2.30.5.1.20 TEXT\_GetUserData()

#### Description

Prototype explained at the beginning of the chapter as `<WIDGET>_GetUserData()` on page 994.

### 6.2.30.5.1.21 TEXT\_GetWrapMode()

#### Description

Returns the currently used mode for wrapping text of the given TEXT widget.

#### Prototype

```
GUI_WRAPMODE TEXT_GetWrapMode(TEXT_Handle hObj);
```

#### Parameters

| Parameter            | Description                |
|----------------------|----------------------------|
| <a href="#">hObj</a> | Handle of the TEXT widget. |

#### Return value

Currently used wrap mode.

### 6.2.30.5.1.22 TEXT\_SetBkColor()

#### Description

Sets the background color of the TEXT widget.

#### Prototype

```
void TEXT_SetBkColor(TEXT_Handle hObj,  
                    GUI_COLOR   Color);
```

#### Parameters

| Parameter          | Description  |
|--------------------|--|
| <code>hObj</code>  | Handle of TEXT widget.   |
| <code>Color</code> | <code>Color</code> to be used for the background. (range 0x000000 and 0xFFFFFFFF or a valid color define) GUI_INVALID_COLOR to make background transparent |

#### Additional information

The background of this widget can either be filled with any available color or transparent. If a valid RGB color is specified, the background is filled with the color, otherwise the background (typically the content of the parent window) is visible. If the background is transparent, the widget is treated as transparent window, otherwise as non-transparent window. Note that using a background color allows more efficient (faster) rendering.

### 6.2.30.5.1.23 TEXT\_SetDec()

#### Description

This function sets a value which gets displayed by the TEXT widget in decimal mode.

#### Prototype

```
int TEXT_SetDec(TEXT_Handle hObj,
                I32         v,
                U8          Len,
                U8          Shift,
                U8          Signed,
                U8          Space);
```

#### Parameters

| Parameter           | Description   |
|---------------------|---|
| <code>hObj</code>   | Handle of TEXT widget.  |
| <code>v</code>      | Value to be displayed.  |
| <code>Len</code>    | Number of digits to be displayed. If this value is higher than the numbers to be displayed, leading zeros will be added.                        |
| <code>Shift</code>  | This sets the position of the decimal point.  |
| <code>Signed</code> | If 1, a minus or plus sign will be added to the value. If the value is negative a minus is displayed regardless of the value of this parameter. |
| <code>Space</code>  | If set to 1 the leading zeros will be replaced by blank spaces.   |

#### Return value

0        on success  
 1        on error.

### 6.2.30.5.1.24 TEXT\_SetDefaultFont()

#### Description

Sets the default font used for TEXT widgets.

#### Prototype

```
void TEXT_SetDefaultFont(const GUI_FONT * pFont);
```

#### Parameters

| Parameter          | Description                               |
|--------------------|---|
| <code>pFont</code> | Pointer to the font to be set as default. |



### 6.2.30.5.1.25 TEXT\_SetDefaultFrameColor()

#### Description

Sets the default frame color used for framed fonts.

#### Prototype

```
void TEXT_SetDefaultFrameColor(GUI_COLOR Color);
```

#### Parameters

| Parameter | Description       |
|-----------|-------------------|
| Color     | Color to be used. |

### 6.2.30.5.1.26 TEXT\_SetDefaultRotation()

#### Description

Sets the default rotation mode for new TEXT widgets.

#### Prototype

```
GUI_ROTATION *TEXT_SetDefaultRotation(const GUI_ROTATION * pLCD_Api);
```

#### Parameters

| Parameter                | Description   |
|--------------------------|---|
| <a href="#">pLCD_Api</a> | Text rotation mode. See <i>Text rotation modes</i> on page 254 for a list of possible values. |

#### Return value

Default text rotation mode.

### 6.2.30.5.1.27 TEXT\_SetDefaultTextColor()

#### Description

Sets the default text color used for TEXT widgets.

#### Prototype

```
void TEXT_SetDefaultTextColor(GUI_COLOR Color);
```

#### Parameters

| Parameter | Description       |
|-----------|-------------------|
| Color     | Color to be used. |

### 6.2.30.5.1.28 TEXT\_SetDefaultWrapMode()

#### Description

Sets the default text wrapping mode used for new TEXT widgets.

#### Prototype

```
GUI_WRAPMODE TEXT_SetDefaultWrapMode(GUI_WRAPMODE WrapMode);
```

#### Parameters

| Parameter                | Description  |
|--------------------------|--|
| <a href="#">WrapMode</a> | Default text wrapping mode used for new TEXT widgets. See <i>GUI_WRAPMODE</i> on page 256. |

#### Return value

Previous default text wrapping mode.

#### Additional information

The default wrapping mode for TEXT widgets is *GUI\_WRAPMODE\_NONE*. For details about text wrapping, refer to *GUI\_DispStringInRectWrap()*.

### 6.2.30.5.1.29 TEXT\_SetFont()

#### Description

Sets the font to be used for a specified TEXT widget.

#### Prototype

```
void TEXT_SetFont(      TEXT_Handle  hObj,  
                    const GUI_FONT  * pFont);
```

#### Parameters

| Parameter          | Description                     |
|--------------------|---------------------------------|
| <code>hObj</code>  | Handle of TEXT widget.          |
| <code>pFont</code> | Pointer to the font to be used. |

### 6.2.30.5.1.30 TEXT\_SetFrameColor()

#### Description

Sets the frame color for fonts of a specified TEXT widget.

#### Prototype

```
void TEXT_SetFrameColor(TEXT_Handle hObj,  
                        GUI_COLOR  Color);
```

#### Parameters

| Parameter          | Description            |
|--------------------|------------------------|
| <code>hObj</code>  | Handle of TEXT widget. |
| <code>Color</code> | New frame color.       |

### 6.2.30.5.1.31 TEXT\_SetRotation()

#### Description

Sets the text rotation for a TEXT widget.

#### Prototype

```
void TEXT_SetRotation(    TEXT_Handle    hObj,  
                        const GUI_ROTATION * pLCD_Api);
```

#### Parameters

| Parameter                | Description   |
|--------------------------|---|
| <a href="#">hObj</a>     | Handle of TEXT widget.  |
| <a href="#">pLCD_Api</a> | Text rotation mode. See full list under <i>Text rotation modes</i> on page 254. |

#### Additional information

To learn more about rotating text in emWin, refer to `GUI_DispStringInRectEx()`.

### 6.2.30.5.1.32 TEXT\_SetText()

#### Description

Sets the text to be used for a specified TEXT widget.

#### Prototype

```
int TEXT_SetText(      TEXT_Handle  hObj,  
                    const char    * s);
```

#### Parameters

| Parameter         | Description            |
|-------------------|------------------------|
| <code>hObj</code> | Handle of TEXT widget. |
| <code>s</code>    | Text to be displayed.  |

#### Return value

0        on success  
1        on error.



### 6.2.30.5.1.33 TEXT\_SetTextAlign()

#### Description

Sets the text alignment of a specified TEXT widget.

#### Prototype

```
void TEXT_SetTextAlign(TEXT_Handle hObj,  
                       int         Align);
```

#### Parameters

| Parameter             | Description  |
|-----------------------|--|
| <a href="#">hObj</a>  | Handle of TEXT widget.                                     |
| <a href="#">Align</a> | Text alignment. See <i>TEXT create flags</i> on page 2234. |

### 6.2.30.5.1.34 TEXT\_SetTextColor()

#### Description

Sets the text color of a specified TEXT widget.

#### Prototype

```
void TEXT_SetTextColor(TEXT_Handle hObj,  
                       GUI_COLOR  Color);
```

#### Parameters

| Parameter          | Description            |
|--------------------|------------------------|
| <code>hObj</code>  | Handle of TEXT widget. |
| <code>Color</code> | New text color.        |

### 6.2.30.5.1.35 TEXT\_SetTextOffset()

#### Description

Sets an X- and Y-offset for the text of a TEXT widget.

#### Prototype

```
void TEXT_SetTextOffset(TEXT_Handle hObj,  
                        int          xPos,  
                        int          yPos);
```

#### Parameters

| Parameter         | Description            |
|-------------------|------------------------|
| <code>hObj</code> | Handle of TEXT widget. |
| <code>xPos</code> | X-offset in pixels.    |
| <code>yPos</code> | Y-offset in pixels.    |

### 6.2.30.5.1.36 TEXT\_SetUserData()

#### Description

Prototype explained at the beginning of the chapter as `<WIDGET>_SetUserData()` on page 995.

### 6.2.30.5.1.37 TEXT\_SetWrapMode()

#### Description

Sets the wrapping mode of a specified TEXT widget.

#### Prototype

```
void TEXT_SetWrapMode(TEXT_Handle hObj,  
                      GUI_WRAPMODE WrapMode);
```

#### Parameters

| Parameter                | Description  |
|--------------------------|--|
| <a href="#">hObj</a>     | Handle of TEXT widget.   |
| <a href="#">WrapMode</a> | See <i>GUI_WRAPMODE</i> on page 256 for a list of possible values. |

#### Additional information

The default wrapping mode for TEXT widgets is *GUI\_WRAPMODE\_NONE*. For more details about text wrapping, refer to *GUI\_DispStringInRectWrap()*.

## 6.2.30.5.2 Defines

### 6.2.30.5.2.1 TEXT create flags

#### Description

Create flags used by the TEXT widget. These flags are used for the `ExFlags` parameter of `TEXT_CreateEx()`.

#### Definition

```
#define TEXT_CF_LEFT      (0)
#define TEXT_CF_HCENTER  (2 << 0)
#define TEXT_CF_RIGHT    (1 << 0)
#define TEXT_CF_TOP      (0)
#define TEXT_CF_VCENTER  (3 << 2)
#define TEXT_CF_BOTTOM   (1 << 2)
```

#### Symbols

| Definition                   | Description                                      |
|------------------------------|--|
| Horizontal alignment         |  |
| <code>TEXT_CF_LEFT</code>    | Align X-position left.                           |
| <code>TEXT_CF_HCENTER</code> | Center X-position.                               |
| <code>TEXT_CF_RIGHT</code>   | Align X-position right.                          |
| Vertical alignment           |  |
| <code>TEXT_CF_TOP</code>     | Align Y-position with top of characters.         |
| <code>TEXT_CF_VCENTER</code> | Center Y-position.                               |
| <code>TEXT_CF_BOTTOM</code>  | Align Y-position with bottom pixel line of font. |

#### Additional information

These flags are identical to the Text alignment flags and can be used the same way, meaning horizontal and vertical flags can be OR-combined.

## 6.2.30.6 Examples

There is no special sample for this widget, since many of the emWin samples use it:

- `DIALOG_Count.c`
- `DIALOG_Radio.c`
- `WIDGET_GraphXY.c`
- ...

### 6.2.31 TREEVIEW: Treeview widget

A TREEVIEW widget can be used to show a hierarchical view of information like files in a directory or items of an index, whereas each item can be a node or a leaf. Each node can have a number of sub items and can be closed or opened.

A node consists of a button image, which shows a plus sign in closed state or a minus sign in open state, two item images (one for closed and one for open state) and the item text. Pressing the button image or double clicking the item image toggles the state (open or closed) of the node.

A leaf consists of an item image and the item text. The current selection can be marked by highlighting the item text or by highlighting the whole row. All items of a tree are joined by lines per default.

**Note**

All TREEVIEW-related routines are located in the file(s) TREEVIEW\*.c, TREEVIEW\*.h. All identifiers are prefixed TREEVIEW.

The table below shows the appearances of the TREEVIEW widget:

| Description  | TREEVIEW widget |
|--|-----------------|
| TREEVIEW widget with row selection enabled.                          |                 |
| TREEVIEW widget with text selection enabled.                         |                 |
| TREEVIEW widget with some application defined bitmaps and lines off. |                 |



## 6.2.31.1 Description of terms

### Item

This means a TREEVIEW item which can be a leaf or a node.

### Leaf

A leaf is a TREEVIEW item which is not able to have any children. It is represented by the leaf bitmap and the item text.

### Node

A node is a TREEVIEW item which is able to have children. It is represented by the button bitmap, the node bitmap and the item text. The state of the node can be toggled by pressing the button bitmap or by double clicking the node bitmap or the selected area of the item. In open state the children are visible below the node at the next level of indentation.

### Button bitmap

This means the bitmap visible at nodes which can be pressed to toggle the state of the node.

### Item bitmap

Left beside the item text the item bitmap is shown. Which bitmap is shown depends in the item (leaf or node) and in case of a node it also depends on the state, collapsed or expanded.

### Expanded state

In expanded state the children of a node are visible and the minus sign is shown in the button bitmap.

### Collapsed state





In collapsed state the children of a node are hidden and the plus sign is shown in the button bitmap.

### Joining lines

Lines which are used to connect the items of a tree. The lines connect the button bitmaps of the nodes and the item bitmaps of the leafs according to the hierarchy of the tree.

## 6.2.31.2 Configuration options

| Type | Macro                       | Default       | Description                            |
|------|-----------------------------|---------------|--|
| S    | TREEVIEW_FONT_DEFAULT       | &GUI_Font13_1 | Default font used to draw the text.    |
| N    | TREEVIEW_BKCOLOR0_DEFAULT   | GUI_WHITE     | Background color for unselected state. |
| N    | TREEVIEW_BKCOLOR1_DEFAULT   | GUI_BLUE      | Background color for selected state.   |
| N    | TREEVIEW_BKCOLOR2_DEFAULT   | 0xC0C0C0      | Background color for disabled state.   |
| N    | TREEVIEW_TEXTCOLOR0_DEFAULT | GUI_BLACK     | Text color for unselected state.       |
| N    | TREEVIEW_TEXTCOLOR1_DEFAULT | GUI_WHITE     | Text color for selected state.         |
| N    | TREEVIEW_TEXTCOLOR2_DEFAULT | GUI_GRAY      | Text color for disabled state.         |

| Type | Macro                         | Default   | Description                          |
|------|-------------------------------|---|--------------------------------------|
| N    | TREEVIEW_LINECOLOR0_DEFAULT   | GUI_BLACK   | Line color for unselected state.     |
| N    | TREEVIEW_LINECOLOR1_DEFAULT   | GUI_WHITE   | Line color for selected state.       |
| N    | TREEVIEW_LINECOLOR2_DEFAULT   | GUI_GRAY  | Line color for disabled state.       |
| S    | TREEVIEW_IMAGE_CLOSED_DEFAULT |  | Item image for node in closed state. |
| S    | TREEVIEW_IMAGE_OPEN_DEFAULT   |  | Item image for node in open state.   |
| S    | TREEVIEW_IMAGE_LEAF_DEFAULT   |  | Item image for leaf.                 |
| S    | TREEVIEW_IMAGE_PLUS_DEFAULT   |  | Plus sign.                           |
| S    | TREEVIEW_IMAGE_MINUS_DEFAULT  |  | Minus sign.                          |
| N    | TREEVIEW_INDENT_DEFAULT       | 16  | Number of pixels for indenting.      |
| N    | TREEVIEW_TEXT_INDENT_DEFAULT  | 20  | Number of pixels for indenting text. |

### 6.2.31.3 Predefined IDs

The following symbols define IDs which may be used to make TREEVIEW widgets distinguishable from creation.

```
#define GUI_ID_TREEVIEW0    0x240
#define GUI_ID_TREEVIEW1    0x241
#define GUI_ID_TREEVIEW2    0x242
#define GUI_ID_TREEVIEW3    0x243
#define GUI_ID_TREEVIEW4    0x244
#define GUI_ID_TREEVIEW5    0x245
#define GUI_ID_TREEVIEW6    0x246
#define GUI_ID_TREEVIEW7    0x247
#define GUI_ID_TREEVIEW8    0x248
#define GUI_ID_TREEVIEW9    0x249
```

### 6.2.31.4 Notification codes

The following events are sent from a treeview widget to its parent window as part of a WM\_NOTIFY\_PARENT message:

| Message                     | Description  |
|-----------------------------|--|
| WM_NOTIFICATION_CLICKED     | TREEVIEW has been clicked.   |
| WM_NOTIFICATION_RELEASED    | TREEVIEW has been released.  |
| WM_NOTIFICATION_MOVED_OUT   | TREEVIEW has been clicked and pointer has been moved out of the widget area without releasing. |
| WM_NOTIFICATION_SEL_CHANGED | Value (selection) of the TREEVIEW widget has changed.  |

### 6.2.31.5 Keyboard reaction

The widget reacts to the following keys if it has the input focus:

| Key           | Reaction  |
|---------------|---|
| GUI_KEY_RIGHT | If the cursor is at a closed node, the node is opened.<br>If the cursor is at an open node the cursor moves to the first child of the node.   |
| GUI_KEY_DOWN  | The cursor moves to the next visible item below the current position.   |
| GUI_KEY_LEFT  | If the cursor is at a leaf the cursor moves to the parent node of the item.<br>If the cursor is at an open node, the node will be closed.<br>If the cursor is at a closed node, the cursor moves to the next parent node. |
| GUI_KEY_UP    | The cursor moves to the previous visible item above the current position.   |

### 6.2.31.6 TREEVIEW API

The table below lists the available TREEVIEW-related routines of emWin in alphabetical order. Detailed descriptions of the routines follow.

#### Functions

| Routine                                     | Description  |
|---|--|
| Common routines                             |  |
| <code>TREEVIEW_AttachItem()</code>          | Attaches an already existing item to the TREEVIEW widget.                          |
| <code>TREEVIEW_CreateEx()</code>            | Creates a TREEVIEW widget.   |
| <code>TREEVIEW_CreateIndirect()</code>      | Creates a TREEVIEW widget from a resource table.                                   |
| <code>TREEVIEW_CreateUser()</code>          | Creates a TREEVIEW widget using extra bytes as user data.                          |
| <code>TREEVIEW_DecSel()</code>              | Moves the cursor to the previous visible item.                                     |
| <code>TREEVIEW_GetDefaultBkColor()</code>   | Returns the default background color.  |
| <code>TREEVIEW_GetDefaultFont()</code>      | Returns the default font used to draw the item text.                               |
| <code>TREEVIEW_GetDefaultLineColor()</code> | Returns the default line color.  |
| <code>TREEVIEW_GetDefaultTextColor()</code> | Returns the default text color.  |
| <code>TREEVIEW_GetItem()</code>             | Returns the requested item.  |
| <code>TREEVIEW_GetSel()</code>              | Returns the currently selected item.   |
| <code>TREEVIEW_GetUserData()</code>         | Retrieves the data set with <code>TREEVIEW_SetUserData()</code> .                  |
| <code>TREEVIEW_IncSel()</code>              | Moves the cursor to the next visible item of the given TREEVIEW widget.            |
| <code>TREEVIEW_InsertItem()</code>          | The function creates and inserts one new TREEVIEW item relative to the given item. |
| <code>TREEVIEW_ScrollToSel()</code>         | Scrolls the given TREEVIEW widget to show the current selection.                   |
| <code>TREEVIEW_SetAutoScrollH()</code>      | Enables or disables the use of an automatic horizontal scroll bar.                 |

| Routine                                     | Description  |
|---|--|
| <code>TREEVIEW_SetAutoScrollV()</code>      | Enables or disables the use of an automatic vertical scroll bar.             |
| <code>TREEVIEW_SetBitmapOffset()</code>     | Sets the offset of the plus/minus bitmap.                                    |
| <code>TREEVIEW_SetBkColor()</code>          | Sets the background color.   |
| <code>TREEVIEW_SetDefaultBkColor()</code>   | Sets the default background color used for new TREEVIEW widgets.             |
| <code>TREEVIEW_SetDefaultFont()</code>      | Sets the default font used for new TREEVIEW widgets.                         |
| <code>TREEVIEW_SetDefaultLineColor()</code> | Sets the default line color used for new TREEVIEW widgets.                   |
| <code>TREEVIEW_SetDefaultTextColor()</code> | Sets the default text color used for new TREEVIEW widgets.                   |
| <code>TREEVIEW_SetFont()</code>             | Sets the font to be used to draw the item text of the given TREEVIEW widget. |
| <code>TREEVIEW_SetHasLines()</code>         | Manages the visibility of the joining lines between the TREEVIEW items.      |
| <code>TREEVIEW_SetImage()</code>            | Sets the images used to draw the TREEVIEW items.                             |
| <code>TREEVIEW_SetIndent()</code>           | Sets the indentation of TREEVIEW items in pixels.                            |
| <code>TREEVIEW_SetLineColor()</code>        | Sets the color used to draw the joining lines between the TREEVIEW items.    |
| <code>TREEVIEW_SetOwnerDraw()</code>        | Enables the TREEVIEW to be owner drawn.                                      |
| <code>TREEVIEW_SetSel()</code>              | Sets the currently selected item of the TREEVIEW widget.                     |
| <code>TREEVIEW_SetSelMode()</code>          | Sets the selection mode of the TREEVIEW widget.                              |
| <code>TREEVIEW_SetTextColor()</code>        | Sets the color used to draw the TREEVIEW items of the given TREEVIEW widget. |
| <code>TREEVIEW_SetTextIndent()</code>       | Sets the indentation of item text in pixels.                                 |
| <code>TREEVIEW_SetUserData()</code>         | Sets the extra data of a TREEVIEW widget.                                    |
| <b>Item related routines</b>                |  |
| <code>TREEVIEW_ITEM_Collapse()</code>       | Collapses the given node.  |
| <code>TREEVIEW_ITEM_CollapseAll()</code>    | Collapses the given node and all subnodes.                                   |
| <code>TREEVIEW_ITEM_Create()</code>         | Creates a new TREEVIEW item.   |
| <code>TREEVIEW_ITEM_Delete()</code>         | Deletes the given TREEVIEW item.   |
| <code>TREEVIEW_ITEM_Detach()</code>         | Detaches the given item without deleting it.                                 |
| <code>TREEVIEW_ITEM_Expand()</code>         | Expands the given node.  |
| <code>TREEVIEW_ITEM_ExpandAll()</code>      | Expands the given node and all subnodes.                                     |
| <code>TREEVIEW_ITEM_GetInfo()</code>        | Returns an information structure of the given item.                          |
| <code>TREEVIEW_ITEM_GetText()</code>        | Returns the item text.   |
| <code>TREEVIEW_ITEM_GetUserData()</code>    | Returns the <code>UserData</code> value of the treeview item.                |
| <code>TREEVIEW_ITEM_SetImage()</code>       | The function sets images to be used only with the given TREEVIEW item.       |
| <code>TREEVIEW_ITEM_SetText()</code>        | The function sets the text of the given item.                                |
| <code>TREEVIEW_ITEM_SetUserData()</code>    | Sets the <code>UserData</code> value of the TREEVIEW item.                   |

## Data structures

| Structure                       | Description  |
|---------------------------------|--|
| <code>TREEVIEW_ITEM_INFO</code> | Structure that contains information about a node in a TREEVIEW widget. |

## Defines

| Group of defines                              | Description   |
|---|---|
| <code>TREEVIEW bitmap indexes</code>          | Bitmap indexes used by the TREEVIEW widget.             |
| <code>TREEVIEW color indexes</code>           | Color indexes used by the TREEVIEW widget.              |
| <code>TREEVIEW create flags</code>            | Create flags used by the TREEVIEW widget.               |
| <code>TREEVIEW item flags</code>              | Define the item type of a newly created TREEVIEW item.  |
| <code>TREEVIEW position flags (get)</code>    | Specify the position when retrieving a TREEVIEW item.   |
| <code>TREEVIEW position flags (insert)</code> | Specify the position when creating a new TREEVIEW item. |
| <code>TREEVIEW selection modes</code>         | Define the selection mode of a TREEVIEW widget.         |

## 6.2.31.6.1 Common routines

### 6.2.31.6.1.1 TREEVIEW\_AttachItem()

#### Description

Attaches an already existing item to the TREEVIEW widget.

#### Prototype

```
int TREEVIEW_AttachItem(TREEVIEW_Handle      hObj,
                       TREEVIEW_ITEM_Handle hItem,
                       TREEVIEW_ITEM_Handle hItemAt,
                       int                   Position);
```

#### Parameters

| Parameter             | Description   |
|-----------------------|---|
| <code>hObj</code>     | Handle of TREEVIEW widget.  |
| <code>hItem</code>    | Handle of item to be attached.  |
| <code>hItemAt</code>  | Handle of a currently attached item which specifies the position to be used.                  |
| <code>Position</code> | See <i>TREEVIEW position flags (insert)</i> on page 2295 for a full list of permitted values. |

#### Return value

0        on success  
1        on error.

#### Additional information

The function can be used for attaching a single item as well as for attaching a complete tree. Note that in case of attaching a tree, the root item of the tree needs to be passed as `hItem`. If attaching the first item to an empty treeview the parameters `hItem` and `Position` should be 0.

### 6.2.31.6.1.2 TREEVIEW\_CreateEx()

#### Description

Creates a TREEVIEW widget of a specified size at a specified location.

#### Prototype

```
TREEVIEW_Handle TREEVIEW_CreateEx(int    x0,
                                   int    y0,
                                   int    xSize,
                                   int    ySize,
                                   WM_HWIN hParent,
                                   int    WinFlags,
                                   int    ExFlags,
                                   int    Id);
```

#### Parameters

| Parameter             | Description  |
|-----------------------|--|
| <code>x0</code>       | Leftmost pixel of the widget (in parent coordinates).  |
| <code>y0</code>       | Topmost pixel of the widget (in parent coordinates).   |
| <code>xSize</code>    | Horizontal size of the widget (in pixels).   |
| <code>ySize</code>    | Vertical size of the widget (in pixels).   |
| <code>hParent</code>  | Handle of parent window. If 0, the new TEXT widget will be a child of the desktop (top-level window).  |
| <code>WinFlags</code> | Window create flags. Typically <code>WM_CF_SHOW</code> in order to make the widget visible immediately (refer to <i>Window create flags</i> on page 977 for a list of available parameter values). |
| <code>ExFlags</code>  | See <i>TREEVIEW create flags</i> on page 2292.   |
| <code>Id</code>       | Window ID of the widget.   |

#### Return value

Handle of the created widget. 0, if the function fails.

#### Additional information

The values of parameter `ExFlags` can be OR-combined.

### 6.2.31.6.1.3 TREEVIEW\_CreateIndirect()

#### Description

The prototype of this function is explained at the beginning of this chapter. Details can be found in the description of the function `<WIDGET>_CreateIndirect()` on page 992. The element `Para` of the according `GUI_WIDGET_CREATE_INFO` structure is not used. The element `Flags` is used according to the parameter `ExFlags` of the function `TREEVIEW_CreateEx()`.



#### 6.2.31.6.1.4 TREEVIEW\_CreateUser()

##### Description

Prototype explained at the beginning of the chapter as `<WIDGET>_CreateUser()` on page 993. For a detailed description of the parameters the function `TREEVIEW_CreateEx()` can be referred to.

### 6.2.31.6.1.5 TREEVIEW\_DecSel()

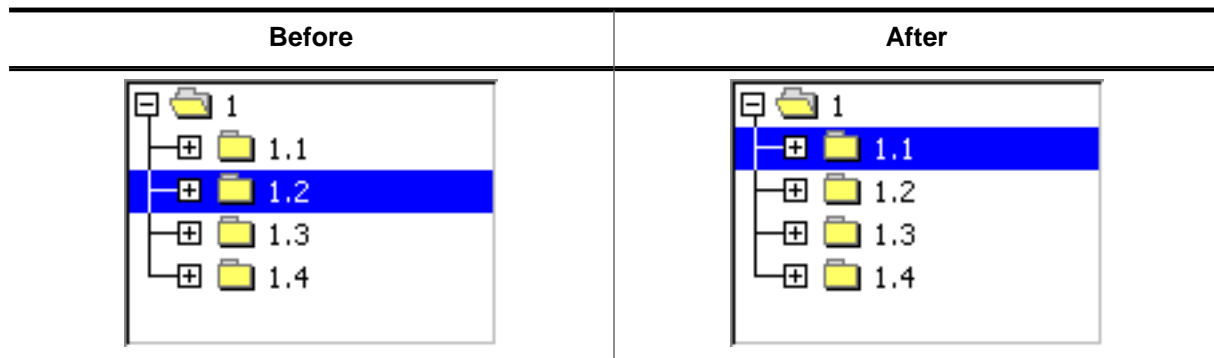

#### Description

Moves the cursor to the previous visible item of the given TREEVIEW widget.

#### Prototype

```
void TREEVIEW_DecSel(TREEVIEW_Handle hObj);
```

#### Parameters

| Parameter         | Description                |
|-------------------|----------------------------|
| <code>hObj</code> | Handle of TREEVIEW widget. |

#### Additional information

If there is no previous visible item the cursor remains on the current position.

### 6.2.31.6.1.6 TREEVIEW\_GetDefaultBkColor()

#### Description

Returns the default background color used for new TREEVIEW widgets.

#### Prototype

```
GUI_COLOR TREEVIEW_GetDefaultBkColor(int Index);
```

#### Parameters

| Parameter             | Description   |
|-----------------------|---|
| <a href="#">Index</a> | See <i>TREEVIEW color indexes</i> on page 2291 for a full list of permitted values. |

#### Return value

Default background color used for new TREEVIEW widgets.

### 6.2.31.6.1.7 TREEVIEW\_GetDefaultFont()

#### Description

Returns the default font used to draw the item text of new TREEVIEW widgets.

#### Prototype

```
GUI_FONT *TREEVIEW_GetDefaultFont(void);
```

#### Return value

Default font used to draw the item text of new TREEVIEW widgets.

### 6.2.31.6.1.8 TREEVIEW\_GetDefaultLineColor()

#### Description

Returns the default color used to draw the joining lines of new TREEVIEW widgets.

#### Prototype

```
GUI_COLOR TREEVIEW_GetDefaultLineColor(int Index);
```

#### Parameters

| Parameter             | Description   |
|-----------------------|---|
| <a href="#">Index</a> | See <i>TREEVIEW color indexes</i> on page 2291 for a full list of permitted values. |

#### Return value

Default color used to draw the joining lines of new treeview widgets.

### 6.2.31.6.1.9 TREEVIEW\_GetDefaultTextColor()

#### Description

Returns the default text color used to draw the item text of new TREEVIEW widgets.

#### Prototype

```
GUI_COLOR TREEVIEW_GetDefaultTextColor(int Index);
```

#### Parameters

| Parameter             | Description   |
|-----------------------|---|
| <a href="#">Index</a> | See <i>TREEVIEW color indexes</i> on page 2291 for a full list of permitted values. |

#### Return value

Default text color used to draw the item text of new TREEVIEW widgets.

### 6.2.31.6.1.10 TREEVIEW\_GetItem()

#### Description

Returns the handle of the requested treeview item.

#### Prototype

```
TREEVIEW_ITEM_Handle TREEVIEW_GetItem(TREEVIEW_Handle hObj,
                                       TREEVIEW_ITEM_Handle hItem,
                                       int Flags);
```

#### Parameters

| Parameter          | Description  |
|--------------------|--|
| <code>hObj</code>  | Handle of TREEVIEW widget.   |
| <code>hItem</code> | Handle of TREEVIEW item specifying the position to start search from.                      |
| <code>Flags</code> | See <i>TREEVIEW position flags (get)</i> on page 2294 for a full list of permitted values. |

#### Return value

Handle of the requested TREEVIEW item on success, otherwise 0.

#### Example

The picture shows a TREEVIEW widget with several items. The following shows how parameter `Flags` can be used for getting TREEVIEW items relative to parameter `hItem`:

- `TREEVIEW_GET_NEXT_SIBLING`  
The next sibling of 1.1 is 1.2.
- `TREEVIEW_GET_PREV_SIBLING`  
The previous sibling of 1.2 is 1.1.
- `TREEVIEW_GET_FIRST_CHILD`  
The first child item of 1.1.1 is 1.1.1.1.
- `TREEVIEW_GET_PARENT`  
The parent item of 1.1 is 1.

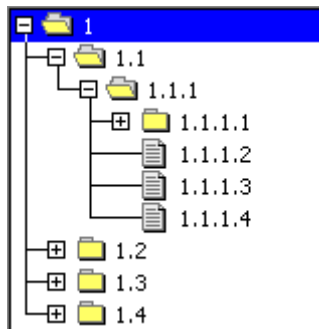

To get the first item when no item is known the `TREEVIEW_GET_FIRST` and `TREEVIEW_GET_LAST` flags are used. In this case `hItem` is 0. If the requested item does not exist, the function returns 0.

### 6.2.31.6.1.11 TREEVIEW\_GetSel()

#### Description

Returns the handle of the currently selected TREEVIEW item.

#### Prototype

```
TREEVIEW_ITEM_Handle TREEVIEW_GetSel(TREEVIEW_Handle hObj);
```

#### Parameters

| Parameter            | Description                |
|----------------------|----------------------------|
| <a href="#">hObj</a> | Handle of TREEVIEW widget. |

#### Return value

Handle of the currently selected treeview item. If no item has been selected the return value is 0.



### 6.2.31.6.1.12 TREEVIEW\_GetUserData()

#### Description

Prototype explained at the beginning of the chapter as `<WIDGET>_GetUserData()` on page 994.

### 6.2.31.6.1.13 TREEVIEW\_IncSel()

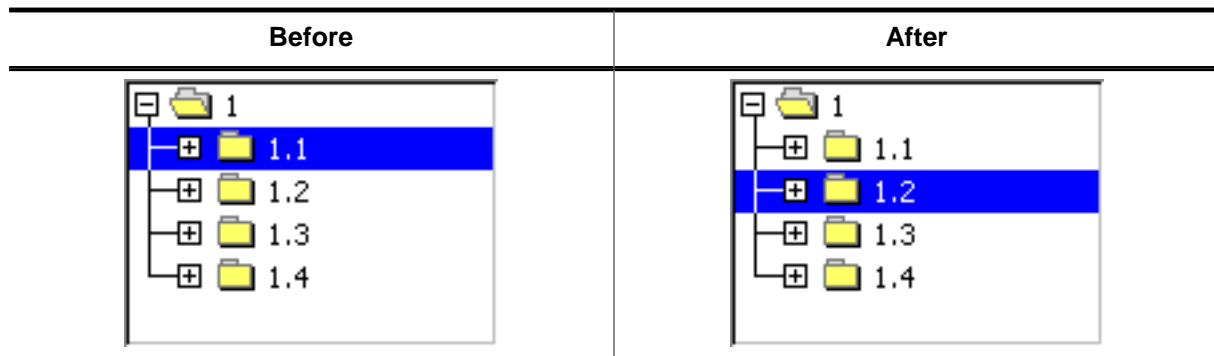

#### Description

Moves the cursor to the next visible item of the given TREEVIEW widget.

#### Prototype

```
void TREEVIEW_IncSel(TREEVIEW_Handle hObj);
```

#### Parameters

| Parameter            | Description                |
|----------------------|----------------------------|
| <a href="#">hObj</a> | Handle of TREEVIEW widget. |

#### Additional information

If there is no next visible item the cursor remains on the current position.

### 6.2.31.6.1.14 TREEVIEW\_InsertItem()



#### Description

The function creates and inserts one new TREEVIEW item relative to the given item.

#### Prototype

```
TREEVIEW_ITEM_Handle TREEVIEW_InsertItem(
    TREEVIEW_Handle      hObj,
    int                  IsNode,
    TREEVIEW_ITEM_Handle hItemPrev,
    int                  Position,
    const char           * s);
```

#### Parameters

| Parameter              | Description   |
|------------------------|---|
| <code>hObj</code>      | Handle of TREEVIEW widget.  |
| <code>IsNode</code>    | See <i>TREEVIEW item flags</i> on page 2293 for a full list of permitted values.              |
| <code>hItemPrev</code> | Handle of TREEVIEW item specifying the position of the new item.                              |
| <code>Position</code>  | See <i>TREEVIEW position flags (insert)</i> on page 2295 for a full list of permitted values. |
| <code>s</code>         | Text of new TREEVIEW item.  |

#### Return value

Handle of the new item on success, otherwise 0.

### 6.2.31.6.1.15 TREEVIEW\_ScrollToSel()

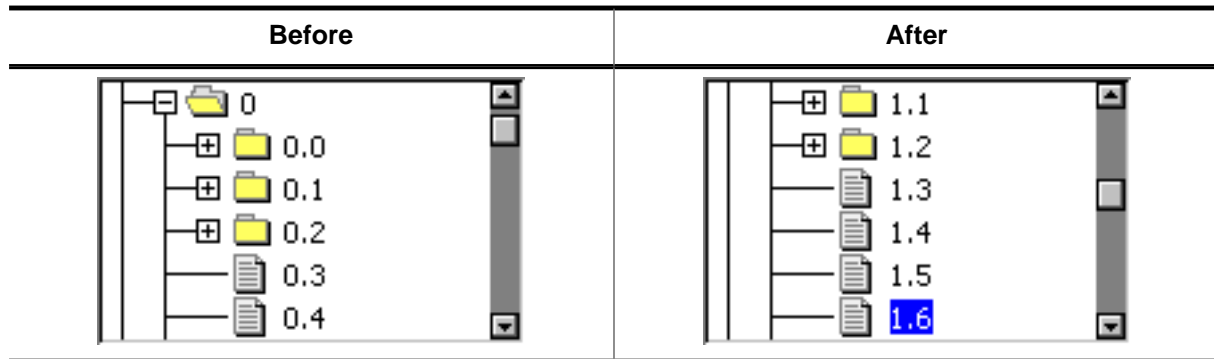

#### Description

Scrolls the given TREEVIEW widget to show the current selection.

#### Prototype

```
void TREEVIEW_ScrollToSel(TREEVIEW_Handle hObj);
```

#### Parameters

| Parameter | Description                |
|-----------|----------------------------|
| hObj      | Handle of TREEVIEW widget. |

### 6.2.31.6.1.16 TREEVIEW\_SetAutoScrollH()

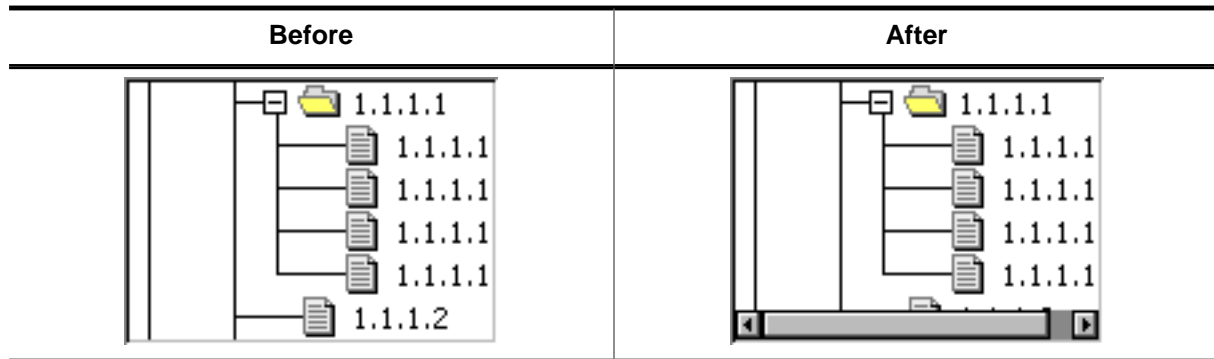

#### Description

Enables or disables the use of an automatic horizontal scroll bar.

#### Prototype

```
void TREEVIEW_SetAutoScrollH(TREEVIEW_Handle hObj,
                             int State);
```

#### Parameters

| Parameter          | Description   |
|--------------------|---|
| <code>hObj</code>  | Handle of TREEVIEW widget.  |
| <code>State</code> | 1 for enabling an automatic horizontal scroll bar, 0 for disabling. |

### 6.2.31.6.1.17 TREEVIEW\_SetAutoScrollV()

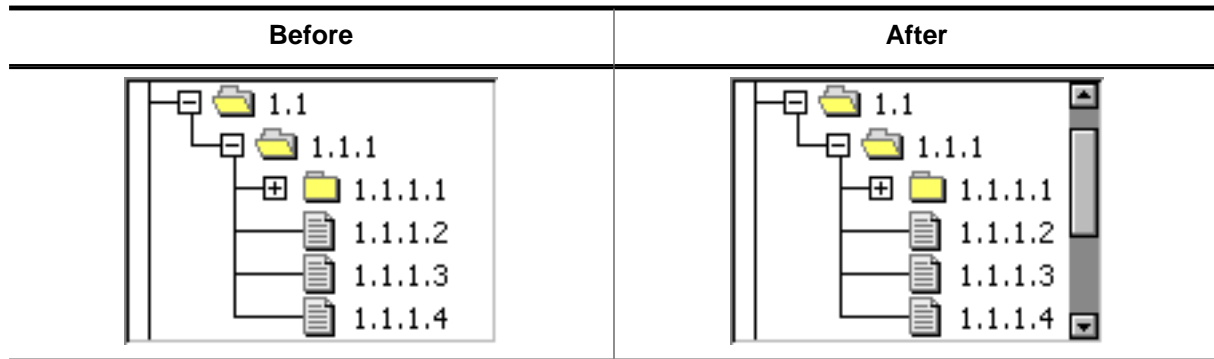

#### Description

Enables or disables the use of an automatic vertical scroll bar.

#### Prototype

```
void TREEVIEW_SetAutoScrollV(TREEVIEW_Handle hObj,
                             int State);
```

#### Parameters

| Parameter          | Description   |
|--------------------|---|
| <code>hObj</code>  | Handle of TREEVIEW widget.  |
| <code>State</code> | 1 for enabling an automatic vertical scroll bar, 0 for disabling. |

### 6.2.31.6.1.18 TREEVIEW\_SetBitmapOffset()

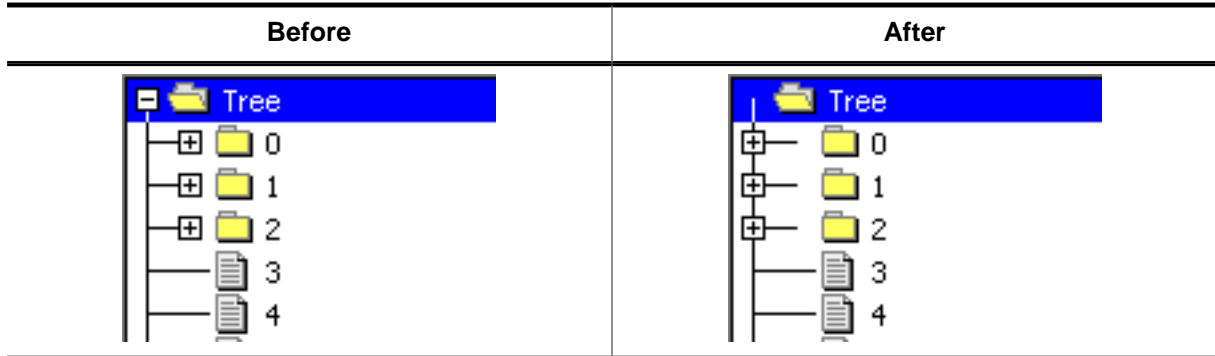

#### Description

Sets the offset of the plus/minus bitmap.

#### Prototype

```
void TREEVIEW_SetBitmapOffset(TREEVIEW_Handle hObj,
                             int Index,
                             int xOff,
                             int yOff);
```

#### Parameters

| Parameter          | Description  |
|--------------------|--|
| <code>hObj</code>  | Handle of TREEVIEW widget.   |
| <code>Index</code> | Currently the only permitted value for this parameter is <code>TREEVIEW_BI_PM</code> . |
| <code>xOff</code>  | Horizontal offset.   |
| <code>yOff</code>  | Vertical offset.   |

#### Additional information

If `xOff` and `yOff` are set to 0 (default), the plus/minus bitmap is centered horizontally and vertically in the indentation space left of the actual item. The indentation space is related to the parent item (if exists) or to the left border of the widget. See “before / after” screenshots of the function `TREEVIEW_SetIndent()`.

### 6.2.31.6.1.19 TREEVIEW\_SetBkColor()

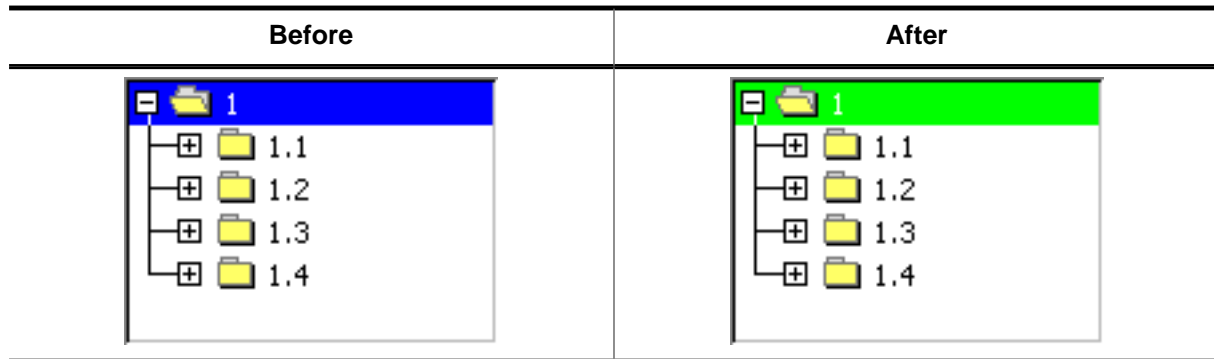

#### Description

Sets the background color of the given TREEVIEW widget.

#### Prototype

```
void TREEVIEW_SetBkColor(TREEVIEW_Handle hObj,
                        int Index,
                        GUI_COLOR Color);
```

#### Parameters

| Parameter             | Description   |
|-----------------------|---|
| <a href="#">hObj</a>  | Handle of TREEVIEW widget.  |
| <a href="#">Index</a> | See <i>TREEVIEW color indexes</i> on page 2291 for a full list of permitted values. |
| <a href="#">Color</a> | <a href="#">Color</a> to be used.   |



### 6.2.31.6.1.20 TREEVIEW\_SetDefaultBkColor()

#### Description

Sets the default background color used for new TREEVIEW widgets.

#### Prototype

```
void TREEVIEW_SetDefaultBkColor(int Index,  
                                GUI_COLOR Color);
```

#### Parameters

| Parameter             | Description   |
|-----------------------|---|
| <a href="#">Index</a> | See <i>TREEVIEW color indexes</i> on page 2291 for a full list of permitted values. |
| <a href="#">Color</a> | <a href="#">Color</a> to be used.   |

### 6.2.31.6.1.21 TREEVIEW\_SetDefaultFont()

#### Description

Sets the default font used for new TREEVIEW widgets.

#### Prototype

```
void TREEVIEW_SetDefaultFont(const GUI_FONT * pFont);
```

#### Parameters

| Parameter          | Description                               |
|--------------------|---|
| <code>pFont</code> | Pointer to GUI_FONT structure to be used. |

### 6.2.31.6.1.22 TREEVIEW\_SetDefaultLineColor()

#### Description

Sets the default line color used for new TREEVIEW widgets.

#### Prototype

```
void TREEVIEW_SetDefaultLineColor(int Index,  
GUI_COLOR Color);
```

#### Parameters

| Parameter             | Description   |
|-----------------------|---|
| <a href="#">Index</a> | See <i>TREEVIEW color indexes</i> on page 2291 for a full list of permitted values. |
| <a href="#">Color</a> | <a href="#">Color</a> to be used.   |

### 6.2.31.6.1.23 TREEVIEW\_SetDefaultTextColor()

#### Description

Sets the default text color used for new TREEVIEW widgets.

#### Prototype

```
void TREEVIEW_SetDefaultTextColor(int Index,  
GUI_COLOR Color);
```

#### Parameters

| Parameter             | Description   |
|-----------------------|---|
| <a href="#">Index</a> | See <i>TREEVIEW color indexes</i> on page 2291 for a full list of permitted values. |
| <a href="#">Color</a> | <a href="#">Color</a> to be used.   |

### 6.2.31.6.1.24 TREEVIEW\_SetFont()

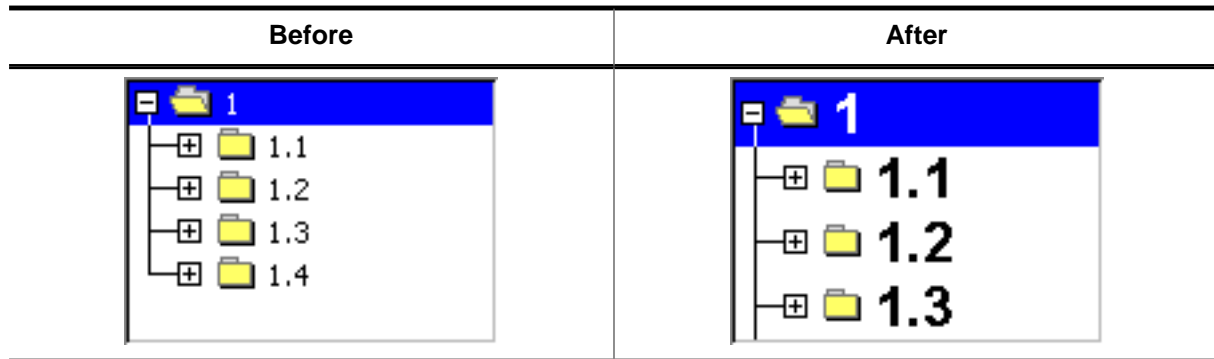

#### Description

Sets the font to be used to draw the item text of the given TREEVIEW widget.

#### Prototype

```
void TREEVIEW_SetFont(    TREEVIEW_Handle  hObj,
                        const GUI_FONT    * pFont);
```

#### Parameters

| Parameter          | Description                               |
|--------------------|---|
| <code>hObj</code>  | Handle of TREEVIEW widget.                |
| <code>pFont</code> | Pointer to GUI_FONT structure to be used. |

### 6.2.31.6.1.25 TREEVIEW\_SetHasLines()

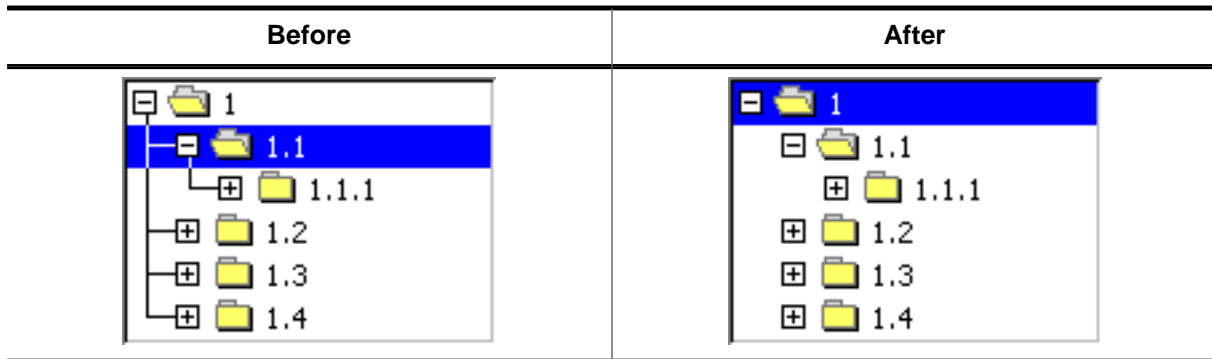

#### Description

Manages the visibility of the joining lines between the TREEVIEW items.

#### Prototype

```
void TREEVIEW_SetHasLines(TREEVIEW_Handle hObj,
                          int State);
```

#### Parameters

| Parameter          | Description   |
|--------------------|---|
| <code>hObj</code>  | Handle of TREEVIEW widget.                            |
| <code>State</code> | 1 for showing the lines, 0 for not showing the lines. |

#### Additional information

Per default the lines are shown.

### 6.2.31.6.1.26 TREEVIEW\_SetImage()

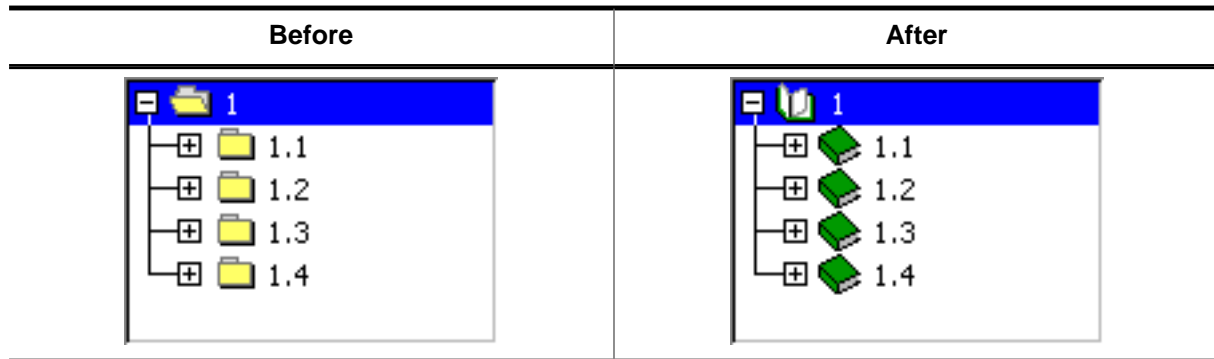

#### Description

Sets the images used to draw the TREEVIEW items.

#### Prototype

```
void TREEVIEW_SetImage(    TREEVIEW_Handle  hObj,
                          int                Index,
                          const GUI_BITMAP  * pBitmap);
```

#### Parameters

| Parameter               | Description  |
|-------------------------|--|
| <a href="#">hObj</a>    | Handle of TREEVIEW widget.   |
| <a href="#">Index</a>   | See <i>TREEVIEW bitmap indexes</i> on page 2290 for a full list of permitted values. |
| <a href="#">pBitmap</a> | Pointer to bitmap structure to be used.  |

### 6.2.31.6.1.27 TREEVIEW\_SetIndent()

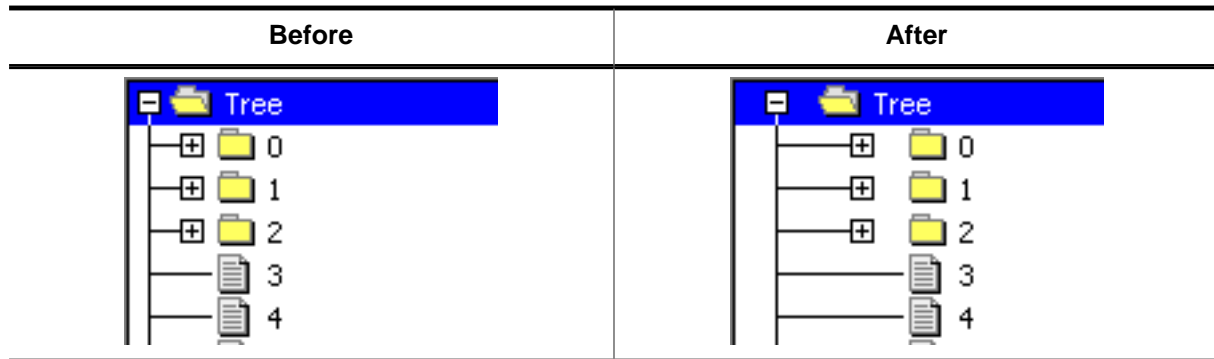

#### Description

Sets the indentation of TREEVIEW items in pixels. Indentation is 16 pixels by default.

#### Prototype

```
int TREEVIEW_SetIndent(TREEVIEW_Handle hObj,
                      int Indent);
```

#### Parameters

| Parameter           | Description                                    |
|---------------------|--|
| <code>hObj</code>   | Handle of TREEVIEW widget.                     |
| <code>Indent</code> | Distance (in pixels) to indent treeview items. |

#### Return value

Previous indentation.



### 6.2.31.6.1.28 TREEVIEW\_SetLineColor()

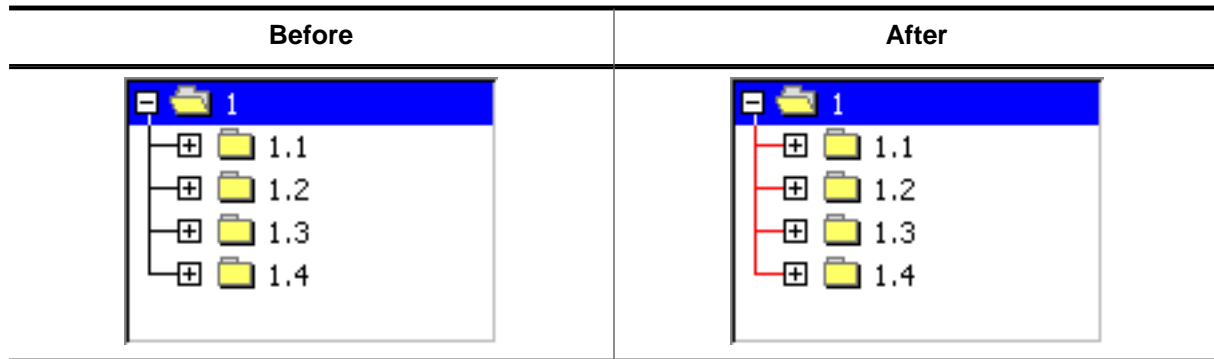

#### Description

Sets the color used to draw the joining lines between the TREEVIEW items.

#### Prototype

```
void TREEVIEW_SetLineColor(TREEVIEW_Handle hObj,
                           int             Index,
                           GUI_COLOR      Color);
```

#### Parameters

| Parameter             | Description   |
|-----------------------|---|
| <a href="#">hObj</a>  | Handle of TREEVIEW widget.  |
| <a href="#">Index</a> | See <i>TREEVIEW color indexes</i> on page 2291 for a full list of permitted values. |
| <a href="#">Color</a> | <a href="#">Color</a> to be used.   |

### 6.2.31.6.1.29 TREEVIEW\_SetOwnerDraw()

#### Description

Enables the TREEVIEW to be owner drawn.

#### Prototype

```
void TREEVIEW_SetOwnerDraw(TREEVIEW_Handle hObj,
                           WIDGET_DRAW_ITEM_FUNC * pfDrawItem);
```

#### Parameters

| Parameter               | Description   |
|-------------------------|---|
| <code>hObj</code>       | Handle of TREEVIEW widget.  |
| <code>pfDrawItem</code> | Pointer to the owner draw function. See <i>User drawn widgets</i> on page 1001. |

#### Supported commands

- WIDGET\_ITEM\_GET\_XSIZE
- WIDGET\_ITEM\_GET\_YSIZE
- WIDGET\_ITEM\_DRAW\_BACKGROUND
- WIDGET\_ITEM\_DRAW\_BITMAP
- WIDGET\_ITEM\_DRAW\_TEXT
- WIDGET\_ITEM\_DRAW\_TICKS

### 6.2.31.6.1.30 TREEVIEW\_SetSel()

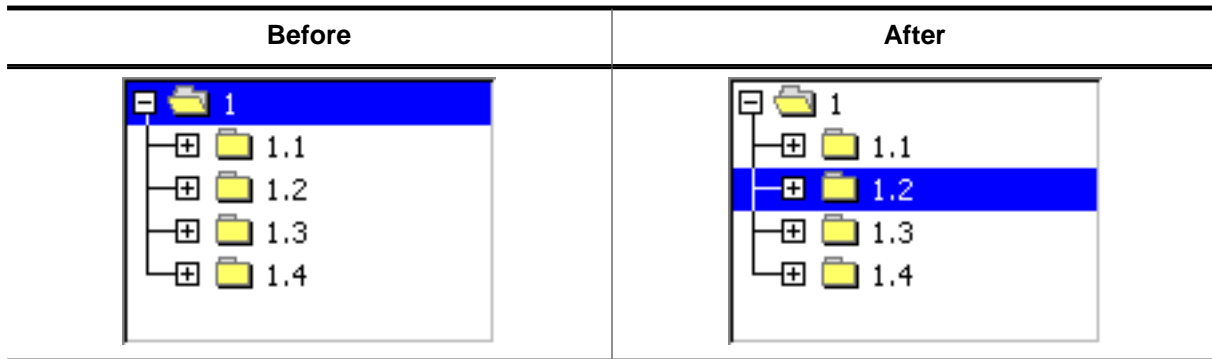

#### Description

Sets the currently selected item of the TREEVIEW widget.

#### Prototype

```
void TREEVIEW_SetSel(TREEVIEW_Handle hObj,
                    TREEVIEW_ITEM_Handle hItem);
```

#### Parameters

| Parameter          | Description                             |
|--------------------|---|
| <code>hObj</code>  | Handle of TREEVIEW widget.              |
| <code>hItem</code> | Handle of treeview item to be selected. |

#### Additional information

If the given TREEVIEW item is a child of a closed node no selection is visible after calling this function.

### 6.2.31.6.1.31 TREEVIEW\_SetSelMode()

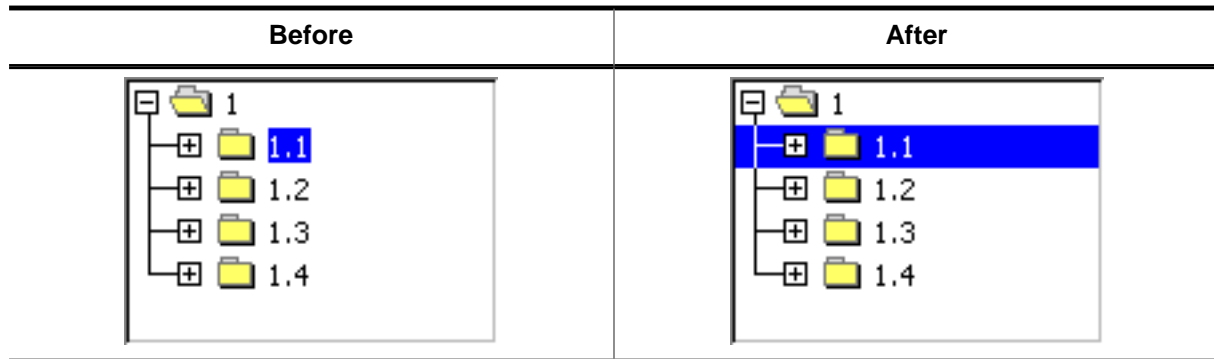

#### Description

Sets the selection mode of the TREEVIEW widget.

#### Prototype

```
void TREEVIEW_SetSelMode(TREEVIEW_Handle hObj,
                        int Mode);
```

#### Parameters

| Parameter         | Description                                       |
|-------------------|---|
| <code>hObj</code> | Handle of TREEVIEW widget.                        |
| <code>Mode</code> | See <i>TREEVIEW selection modes</i> on page 2296. |

#### Additional information

Default selection mode is text selection. If row selection is activated, the complete row can be used to select the item. If text selection is active, only the item text and the item bitmap can be used for selection.

### 6.2.31.6.1.32 TREEVIEW\_SetTextColor()

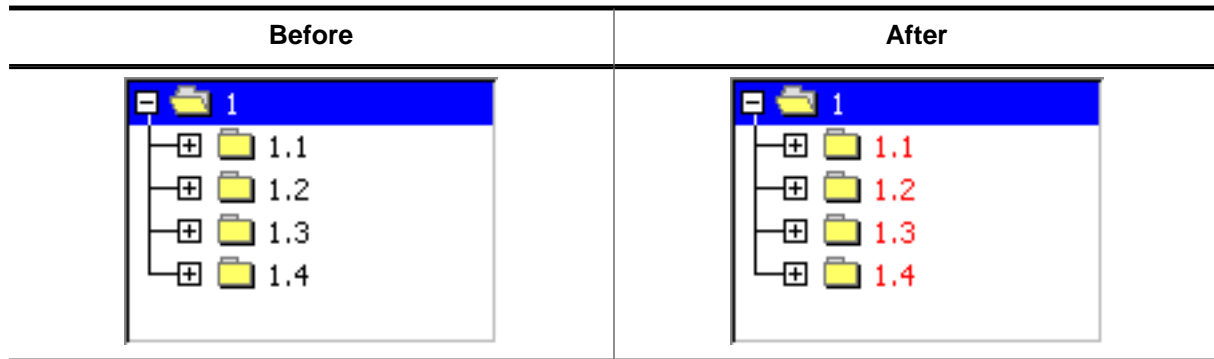

#### Description

Sets the color used to draw the TREEVIEW items of the given TREEVIEW widget.

#### Prototype

```
void TREEVIEW_SetTextColor(TREEVIEW_Handle hObj,
                           int             Index,
                           GUI_COLOR      Color);
```

#### Parameters

| Parameter             | Description   |
|-----------------------|---|
| <a href="#">hObj</a>  | Handle of TREEVIEW widget.  |
| <a href="#">Index</a> | See <i>TREEVIEW color indexes</i> on page 2291 for a full list of permitted values. |
| <a href="#">Color</a> | <a href="#">Color</a> to be used.   |

### 6.2.31.6.1.33 TREEVIEW\_SetTextIndent()

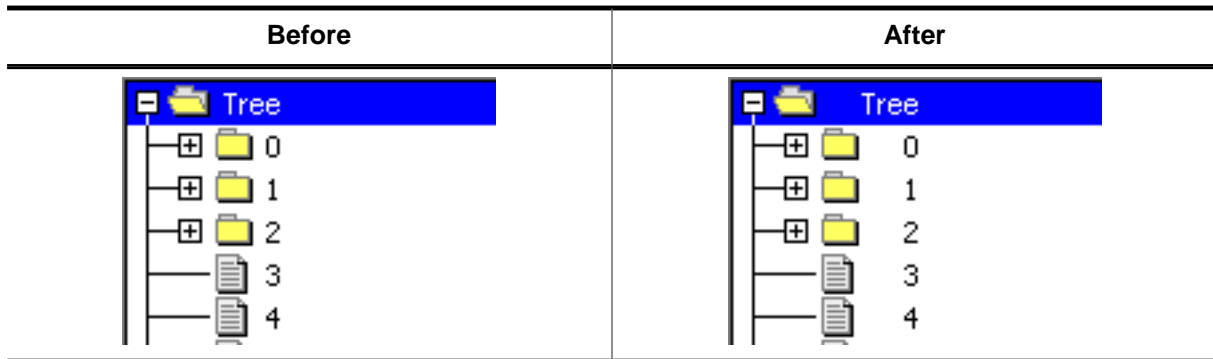

#### Description

Sets the indentation of item text in pixels. Text indentation is 20 pixels by default.

#### Prototype

```
int TREEVIEW_SetTextIndent(TREEVIEW_Handle hObj,
                           int TextIndent);
```

#### Parameters

| Parameter               | Description                  |
|-------------------------|------------------------------|
| <code>hObj</code>       | Handle of TREEVIEW widget.   |
| <code>TextIndent</code> | Text indentation to be used. |

#### Return value

Previous text indentation.

#### 6.2.31.6.1.34 TREEVIEW\_SetUserData()

##### Description

Prototype explained at the beginning of the chapter as `<WIDGET>_SetUserData()` on page 995.

## 6.2.31.6.2 Item related routines

### 6.2.31.6.2.1 TREEVIEW\_ITEM\_Collapse()

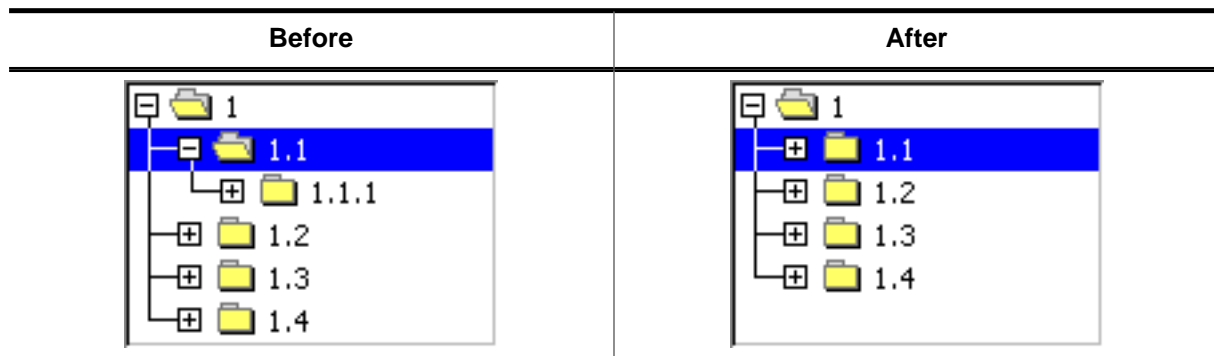

#### Description

Collapses the given node and shows the plus sign afterwards.

#### Prototype

```
void TREEVIEW_ITEM_Collapse(TREEVIEW_ITEM_Handle hItem);
```

#### Parameters

| Parameter          | Description                         |
|--------------------|-------------------------------------|
| <code>hItem</code> | Handle of the item to be collapsed. |

#### Additional information

The given item needs to be a node. Otherwise the function returns immediately.



### 6.2.31.6.2.2 TREEVIEW\_ITEM\_CollapseAll()

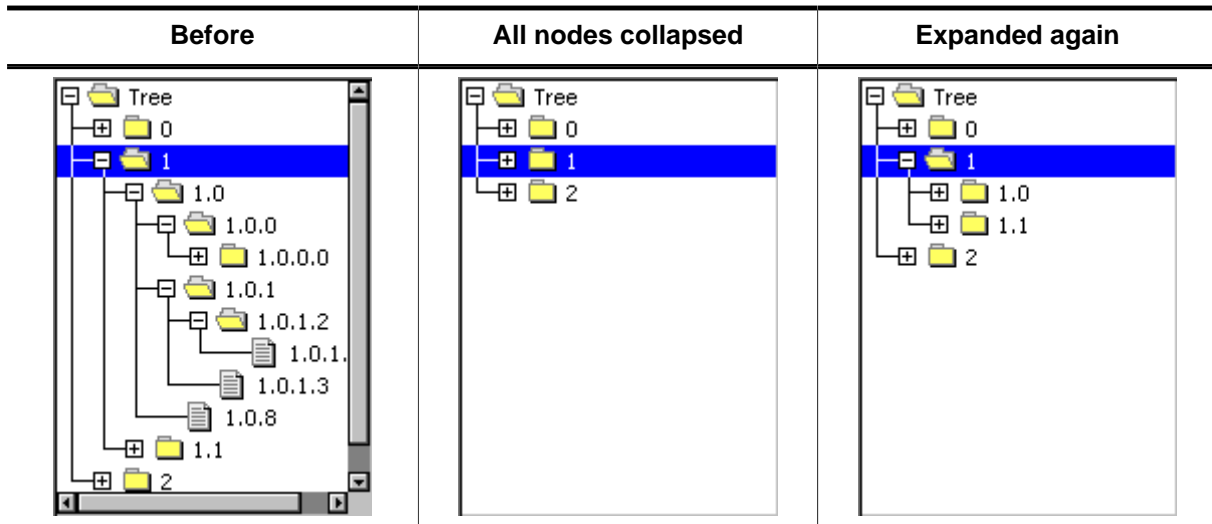

#### Description

Collapses the given node and all subnodes and shows the plus sign afterwards.

#### Prototype

```
void TREEVIEW_ITEM_CollapseAll(TREEVIEW_ITEM_Handle hItem);
```

#### Parameters

| Parameter          | Description                         |
|--------------------|-------------------------------------|
| <code>hItem</code> | Handle of the item to be collapsed. |

#### Additional information

This function collapses all subnodes, so if the given node is expanded again, all subnodes are in collapsed state.

### 6.2.31.6.2.3 TREEVIEW\_ITEM\_Create()

#### Description

Creates a new TREEVIEW item.

#### Prototype

```
TREEVIEW_ITEM_Handle TREEVIEW_ITEM_Create(    int    IsNode,
                                              const char * s,
                                              U32    UserData);
```

#### Parameters

| Parameter             | Description  |
|-----------------------|--|
| <code>IsNode</code>   | See <i>TREEVIEW item flags</i> on page 2293 for a full list of permitted values. |
| <code>s</code>        | Pointer to item text to be shown.  |
| <code>UserData</code> | 32 bit value to be used by the application.                                      |

#### Return value

Handle of new item on success, otherwise 0.

#### Additional information

After creating a treeview item it contains a copy of the text.

#### 6.2.31.6.2.4 TREEVIEW\_ITEM\_Delete()

##### Description

Deletes the given TREEVIEW item.

##### Prototype

```
void TREEVIEW_ITEM_Delete(TREEVIEW_ITEM_Handle hItem);
```

##### Parameters

| Parameter          | Description                   |
|--------------------|-------------------------------|
| <code>hItem</code> | Handle of item to be deleted. |

##### Additional information

If the item is currently not attached to any TREEVIEW, the parameter `hObj` should be 0. The function can be used to delete a single item as well as for deleting a complete tree. In case of deleting a tree the root element of the tree should be passed to the function.

### 6.2.31.6.2.5 TREEVIEW\_ITEM\_Detach()

#### Description

Detaches the given TREEVIEW item from the TREEVIEW widget.

#### Prototype

```
void TREEVIEW_ITEM_Detach(TREEVIEW_ITEM_Handle hItem);
```

#### Parameters

| Parameter          | Description                    |
|--------------------|--------------------------------|
| <code>hItem</code> | Handle of item to be detached. |

#### Additional information

The function detaches the given item and all of its children from the TREEVIEW widget.

### 6.2.31.6.2.6 TREEVIEW\_ITEM\_Expand()

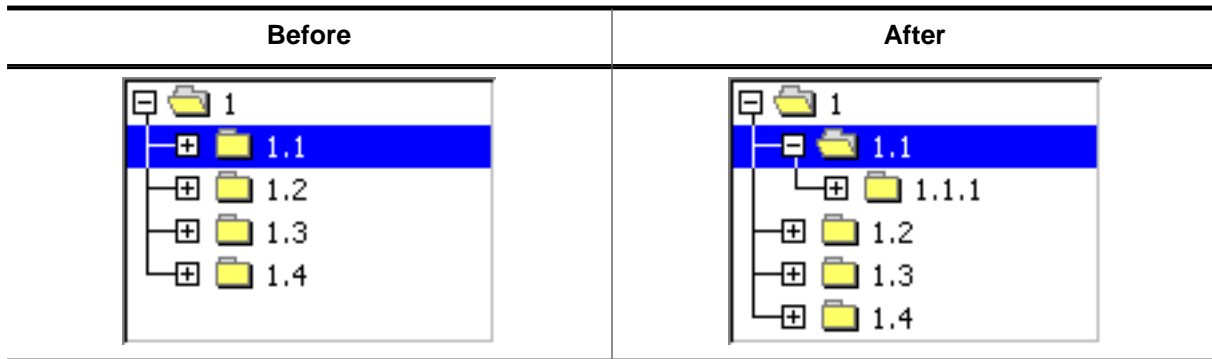

#### Description

Expands the given node and shows the minus sign afterwards.

#### Prototype

```
void TREEVIEW_ITEM_Expand(TREEVIEW_ITEM_Handle hItem);
```

#### Parameters

| Parameter          | Description                    |
|--------------------|--------------------------------|
| <code>hItem</code> | Handle of node to be expanded. |

#### Additional information

The given item needs to be a node. Otherwise the function returns immediately.

### 6.2.31.6.2.7 TREEVIEW\_ITEM\_ExpandAll()

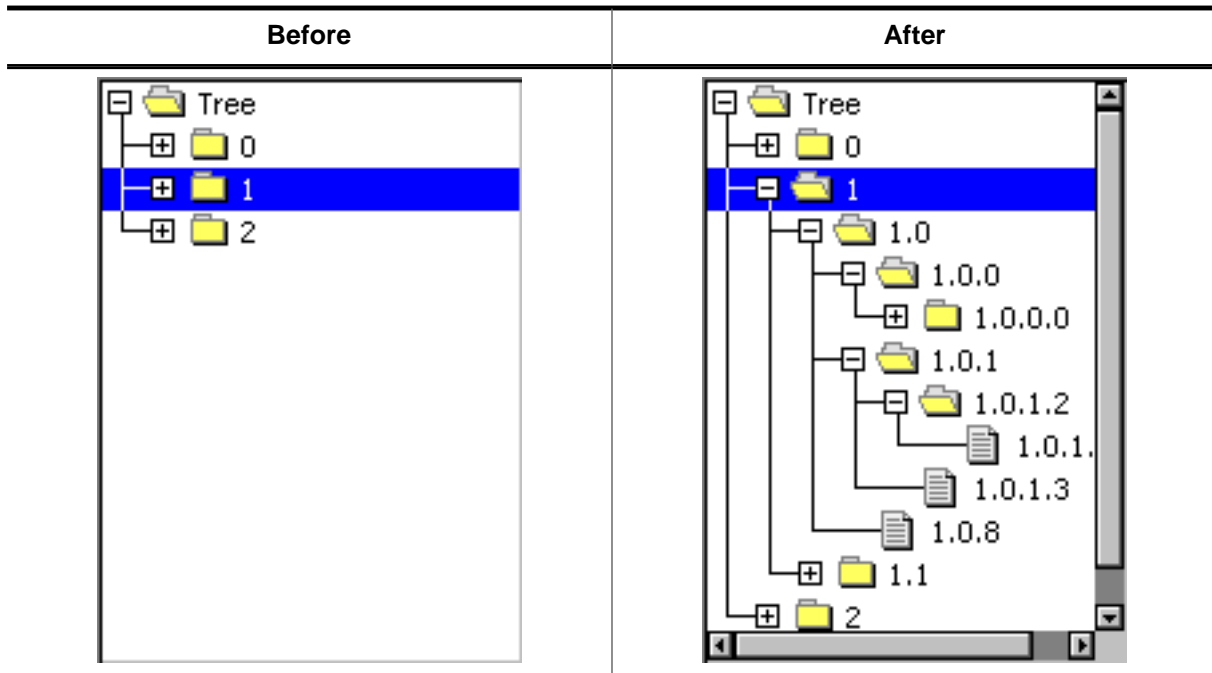

#### Description

Expands the given node and all subnodes and shows the minus sign afterwards.

#### Prototype

```
void TREEVIEW_ITEM_ExpandAll(TREEVIEW_ITEM_Handle hItem);
```

#### Parameters

| Parameter          | Description                    |
|--------------------|--------------------------------|
| <code>hItem</code> | Handle of node to be expanded. |

### 6.2.31.6.2.8 TREEVIEW\_ITEM\_GetInfo()

#### Description

Returns a structure with information about the given item.

#### Prototype

```
void TREEVIEW_ITEM_GetInfo(TREEVIEW_ITEM_Handle hItem,  
                           TREEVIEW_ITEM_INFO * pInfo);
```

#### Parameters

| Parameter          | Description   |
|--------------------|---|
| <code>hItem</code> | Handle of TREEVIEW item.  |
| <code>pInfo</code> | Pointer to a TREEVIEW_ITEM_INFO structure to be filled by the function. |

#### Additional information

The elements of the information structure are explained under *TREEVIEW\_ITEM\_INFO* on page 2289.

### 6.2.31.6.2.9 TREEVIEW\_ITEM\_GetText()

#### Description

Returns the item text of the given TREEVIEW item.

#### Prototype

```
void TREEVIEW_ITEM_GetText (TREEVIEW_ITEM_Handle hItem,  
                             U8 * pBuffer,  
                             int MaxNumBytes);
```

#### Parameters

| Parameter                   | Description                               |
|-----------------------------|---|
| <a href="#">hItem</a>       | Handle of TREEVIEW item.                  |
| <a href="#">pBuffer</a>     | Pointer to buffer filled by the function. |
| <a href="#">MaxNumBytes</a> | Size of the buffer in bytes.              |

#### Additional information

If [MaxNumBytes](#) is less than the item text length the buffer is filled with the first [MaxNumBytes](#) of the item text.



### 6.2.31.6.2.10 TREEVIEW\_ITEM\_GetUserData()

#### Description

The function returns the 32 bit value associated with the given treeview item which can be used by the application program.

#### Prototype

```
U32 TREEVIEW_ITEM_GetUserData(TREEVIEW_ITEM_Handle hItem);
```

#### Parameters

| Parameter          | Description              |
|--------------------|--------------------------|
| <code>hItem</code> | Handle of TREEVIEW item. |

### 6.2.31.6.2.11 TREEVIEW\_ITEM\_SetImage()

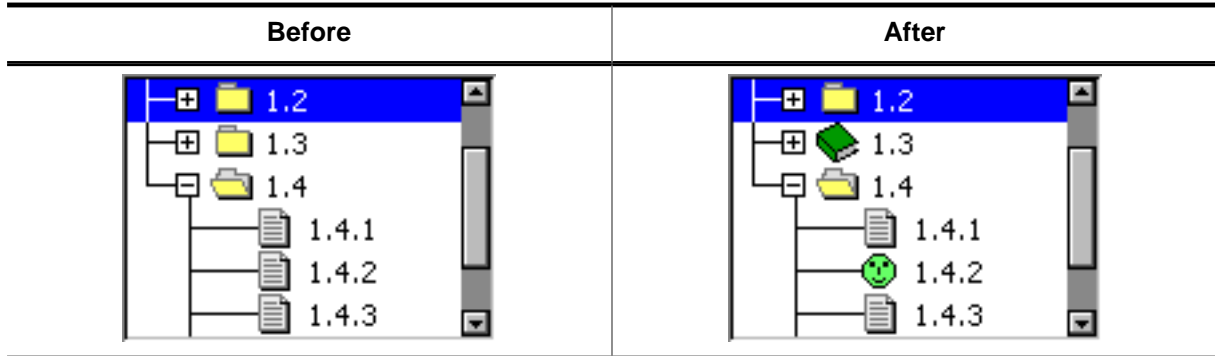

#### Description

The function sets images to be used only with the given TREEVIEW item.

#### Prototype

```
void TREEVIEW_ITEM_SetImage(    TREEVIEW_ITEM_Handle  hItem,
                               int                        Index,
                               const GUI_BITMAP          * pBitmap);
```

#### Parameters

| Parameter            | Description  |
|----------------------|--|
| <code>hItem</code>   | Handle of TREEVIEW item.   |
| <code>Index</code>   | See <i>TREEVIEW bitmap indexes</i> on page 2290. Only the first three values <b>...CLOSED</b> , <b>...OPEN</b> and <b>...LEAF</b> may be used. |
| <code>pBitmap</code> | Pointer to bitmap structure to be used.  |

#### Additional information

This function 'overwrites' the default images of the widget. If no individual image is set the default image is used.

### 6.2.31.6.2.12 TREEVIEW\_ITEM\_SetText()

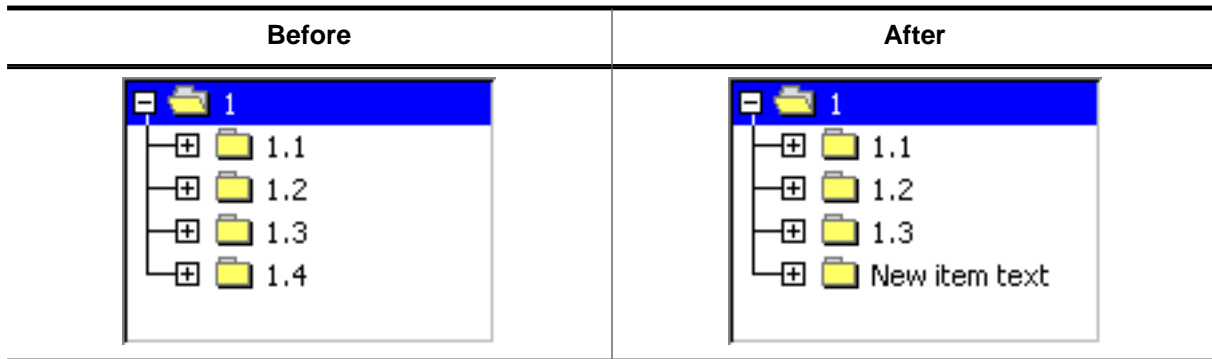

#### Description

The function sets the text of the given item.

#### Prototype

```
TREEVIEW_ITEM_Handle TREEVIEW_ITEM_SetText(    TREEVIEW_ITEM_Handle  hItem,
                                               const char          * s);
```

#### Parameters

| Parameter          | Description                 |
|--------------------|-----------------------------|
| <code>hItem</code> | Handle of TREEVIEW item.    |
| <code>s</code>     | Pointer to text to be used. |

#### Return value

Handle of the TREEVIEW item with the new text.

#### Additional information

The text will be copied into the treeview item. Note that using this function changes the handle of the item. After calling this function, the new handle needs to be used.

### 6.2.31.6.2.13 TREEVIEW\_ITEM\_SetUserData()

#### Description

The function sets a 32 bit value associated with the given treeview item which can be used by the application program.

#### Prototype

```
void TREEVIEW_ITEM_SetUserData(TREEVIEW_ITEM_Handle hItem,  
                               U32                      UserData);
```

#### Parameters

| Parameter             | Description   |
|-----------------------|---|
| <code>hItem</code>    | Handle of TREEVIEW item.                            |
| <code>UserData</code> | 32 bit value to be used by the application program. |

### 6.2.31.6.3 Data structures

#### 6.2.31.6.3.1 TREEVIEW\_ITEM\_INFO

##### Description

Structure that contains information about a node in a TREEVIEW widget.

##### Type definition

```
typedef struct {  
    int  IsNode;  
    int  IsExpanded;  
    int  HasLines;  
    int  HasRowSelect;  
    int  Level;  
} TREEVIEW_ITEM_INFO;
```

##### Structure members

| Member                       | Description                               |
|------------------------------|---|
| <a href="#">IsNode</a>       | 1 if item is a node, 0 if not.            |
| <a href="#">IsExpanded</a>   | 1 if item (node) is open, 0 if closed.    |
| <a href="#">HasLines</a>     | 1 if joining lines are visible, 0 if not. |
| <a href="#">HasRowSelect</a> | 1 if row selection is active, 0 if not.   |
| <a href="#">Level</a>        | Indentation level of item.                |

## 6.2.31.6.4 Defines

### 6.2.31.6.4.1 TREEVIEW bitmap indexes

#### Description

Bitmap indexes used by the TREEVIEW widget. Refer to `TREEVIEW_SetImage()`.

#### Definition

```
#define TREEVIEW_BI_CLOSED    0
#define TREEVIEW_BI_OPEN     1
#define TREEVIEW_BI_LEAF     2
#define TREEVIEW_BI_PLUS     3
#define TREEVIEW_BI_MINUS    4
#define TREEVIEW_BI_PM      5
```

#### Symbols

| Definition                      | Description   |
|---------------------------------|---|
| <code>TREEVIEW_BI_CLOSED</code> | Image of closed nodes.  |
| <code>TREEVIEW_BI_OPEN</code>   | Image of open nodes.  |
| <code>TREEVIEW_BI_LEAF</code>   | Image of leaf.  |
| <code>TREEVIEW_BI_PLUS</code>   | Plus sign of closed nodes.  |
| <code>TREEVIEW_BI_MINUS</code>  | Minus sign of open nodes.   |
| <code>TREEVIEW_BI_PM</code>     | Used by <code>TREEVIEW_SetBitmapOffset()</code> for setting the offset of the plus/minus bitmaps. |

### 6.2.31.6.4.2 TREEVIEW color indexes

#### Description

Color indexes used by the TREEVIEW widget.

#### Definition

```
#define TREEVIEW_CI_UNSEL      0
#define TREEVIEW_CI_SEL       1
#define TREEVIEW_CI_DISABLED  2
```

#### Symbols

| Definition           | Description                  |
|----------------------|------------------------------|
| TREEVIEW_CI_UNSEL    | Color of unselected element. |
| TREEVIEW_CI_SEL      | Color of selected element.   |
| TREEVIEW_CI_DISABLED | Color of disabled element.   |

### 6.2.31.6.4.3 TREEVIEW create flags

#### Description

Create flags used by the TREEVIEW widget. These flags are used for the `ExFlags` parameter of `TREEVIEW_CreateEx()`. These values can be OR-combined.

#### Definition

```
#define TREEVIEW_CF_HIDELINES      (1 << 0)
#define TREEVIEW_CF_ROWSELECT     (1 << 1)
#define TREEVIEW_CF_AUTOSCROLLBAR_H (1 << 2)
#define TREEVIEW_CF_AUTOSCROLLBAR_V (1 << 3)
```

#### Symbols

| Definition                               | Description  |
|--|--|
| <code>TREEVIEW_CF_HIDELINES</code>       | Joining lines are not displayed.                       |
| <code>TREEVIEW_CF_ROWSELECT</code>       | Activates row selection mode.                          |
| <code>TREEVIEW_CF_AUTOSCROLLBAR_H</code> | Enables the use of an automatic horizontal scroll bar. |
| <code>TREEVIEW_CF_AUTOSCROLLBAR_V</code> | Enables the use of an automatic vertical scroll bar.   |



#### 6.2.31.6.4.4 TREEVIEW item flags

##### Description

Flags that define the item type of a newly created TREEVIEW item.

##### Definition

```
#define TREEVIEW_ITEM_TYPE_LEAF    (0 << 0)
#define TREEVIEW_ITEM_TYPE_NODE    (1 << 0)
```

##### Symbols

| Definition                           | Description            |
|--------------------------------------|------------------------|
| <code>TREEVIEW_ITEM_TYPE_LEAF</code> | Used to create a leaf. |
| <code>TREEVIEW_ITEM_TYPE_NODE</code> | Used to create a node. |

### 6.2.31.6.4.5 TREEVIEW position flags (get)

#### Description

These flags are used to specify a position when retrieving an item of the TREEVIEW widget using the routine `TREEVIEW_GetItem()`.

#### Definition

```
#define TREEVIEW_GET_FIRST      0
#define TREEVIEW_GET_LAST      1
#define TREEVIEW_GET_NEXT_SIBLING  2
#define TREEVIEW_GET_PREV_SIBLING  3
#define TREEVIEW_GET_FIRST_CHILD  4
#define TREEVIEW_GET_PARENT      5
```

#### Symbols

| Definition                             | Description   |
|--|---|
| <code>TREEVIEW_GET_FIRST</code>        | Returns the first item of the TREEVIEW widget. Parameter <code>hItem</code> is not required and can be 0. |
| <code>TREEVIEW_GET_LAST</code>         | Returns the last item of the TREEVIEW widget. Parameter <code>hItem</code> is not required and can be 0.  |
| <code>TREEVIEW_GET_NEXT_SIBLING</code> | Returns the next child item of the parent node of <code>hItem</code> .                                    |
| <code>TREEVIEW_GET_PREV_SIBLING</code> | Returns the previous child item of the parent node of <code>hItem</code> .                                |
| <code>TREEVIEW_GET_FIRST_CHILD</code>  | Returns the first child of the given node.  |
| <code>TREEVIEW_GET_PARENT</code>       | Returns the parent node of the given item.  |

### 6.2.31.6.4.6 TREEVIEW position flags (insert)

#### Description

These flags are used to specify a position when creating and inserting a new item into the TREEVIEW widget.

#### Definition

```
#define TREEVIEW_INSERT_ABOVE      0
#define TREEVIEW_INSERT_BELOW     1
#define TREEVIEW_INSERT_FIRST_CHILD 2
```

#### Symbols

| Definition                  | Description  |
|-----------------------------|--|
| TREEVIEW_INSERT_ABOVE       | Attaches the item above the given position at the same indent level as the given position.               |
| TREEVIEW_INSERT_BELOW       | Attaches the item below the given position at the same indent level as the given position.               |
| TREEVIEW_INSERT_FIRST_CHILD | Attaches the item below the given position by indenting it. The given position needs to be a node level. |

### 6.2.31.6.4.7 TREEVIEW selection modes

#### Description

Flags that are used to define the selection mode of a TREEVIEW widget. Refer to `TREEVIEW_SetSelMode()` for more information.

#### Definition

```
#define TREEVIEW_SELMODE_ROW      1
#define TREEVIEW_SELMODE_TEXT    0
```

#### Symbols

| Definition                            | Description                    |
|---------------------------------------|--------------------------------|
| <a href="#">TREEVIEW_SELMODE_ROW</a>  | Activates row selection mode.  |
| <a href="#">TREEVIEW_SELMODE_TEXT</a> | Activates text selection mode. |

### 6.2.31.7 Example

The `Sample` folder contains the following example which shows how the widget can be used:

- `WIDGET_TreeviewTryit.c`

#### Note

Several other examples also make use of this widget and may also be helpful to get familiar with the widget.

#### Screenshot of `WIDGET_TreeviewTryit.c`

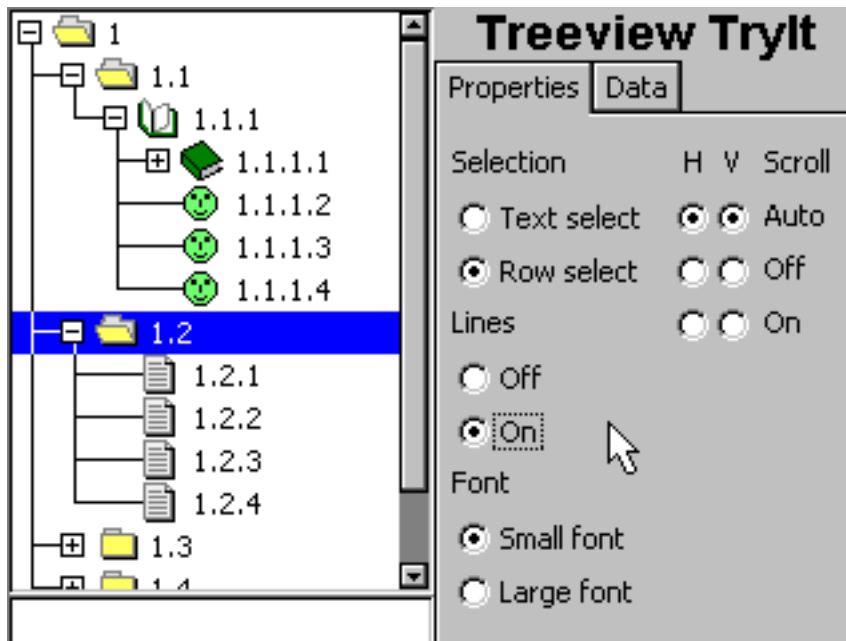

## 6.2.32 WHEEL: Wheel widget

The WHEEL widget is an updated and more versatile version of the LISTWHEEL widget.

The widget can show a given number of texts and/or bitmap arrays on a rotating wheel that the user can scroll through.

| Orientation       | Plain mode | Morph mode |
|-------------------|------------|------------|
| <b>Horizontal</b> |            |            |
| <b>Vertical</b>   |            |            |

**Note**

All WHEEL-related routines are located in the file(s) `WHEEL*.c`, `WHEEL.h`. All identifiers are prefixed `WHEEL`.

### 6.2.32.1 Structure of the WHEEL widget

**Boxes**

Around each item a frame box is drawn. The sizes for center box and the boxes that are not in the center can be set with `WHEEL_SetSizesPlain()` or `WHEEL_SetSizesMorph()`, respectively, depending on the selected mode.

The fill color, frame color, radius and line thickness can be set with `WHEEL_SetBox()`.

Optionally, different box properties can be set to the center item box with `WHEEL_SetCenterBox()`.

**Center item**

The center item is the item currently in the middle of the WHEEL list. To highlight the center item and distinguish it from the other items, specific center properties can be set to the boxes, texts and bitmaps.

The center item is also considered as the selected item. Its index can be retrieved with `WHEEL_GetSel()`.

**Text and bitmap lists**

The content of the WHEEL boxes are a number of text lists and bitmap lists.

To add a list of texts, `WHEEL_AddText()` may be called for each text list to be added.

Optionally, different text properties can be set for the center state using `WHEEL_SetCenterTextAttrPlain()` or `WHEEL_SetCenterTextAttrMorph()`, respectively, depending on the selected mode.

To add lists of bitmaps, `WHEEL_AddBitmaps()` may be called for each bitmap list to be added.

Optionally, different bitmaps to be displayed in the center state may be added with `WHEEL_SetCenterBitmaps()`.

### Morph mode

In morph mode the properties of an item are morphed to the center item properties, as the item is moving to the center position. These item properties are the added texts, bitmaps, colors, and so on.

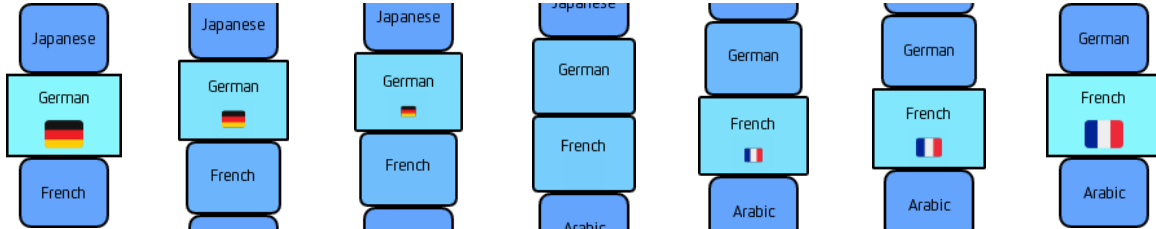

### Plain mode

In plain mode the properties are not morphed. Instead, the items are clipped once they enter the center of the WHEEL.

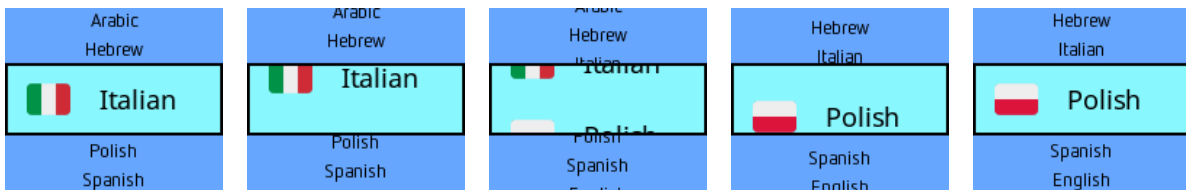

### Stop mode

In stop mode the rotating WHEEL will stop once the first or last element of the list has been reached. It can be enabled by passing the flag `WHEEL_MODE_STOP` when creating the widget.

### Endless mode

In endless mode the rotating WHEEL will continuously move without stopping when the last element has been reached. After the last element, the first element will appear again. It can be enabled by passing the flag `WHEEL_MODE_ENDLESS` when creating the widget.



### Widget orientation

The WHEEL widget can be created horizontally or vertically.

### Overlay

The overlay feature allows a maximum of three bitmaps to be added to the WHEEL. These overlay bitmaps are drawn at a certain position on top of the WHEEL items.

This can be used e.g. to create a highlighting effect. A semi-transparent bitmap can be used as an overlay to highlight the center cell, as shown below.

| Without overlay   | With overlay   |
|---|--|
|  <p>A vertical wheel with five items: Italian, Polish, Spanish, English, and Chinese. The center item, Spanish, is highlighted with a light blue background and a dark border.</p> |  <p>A vertical wheel with five items: Italian, Polish, Spanish, English, and Chinese. The center item, Spanish, is highlighted with a light blue background and a dark border. A semi-transparent dark blue overlay is applied to the center item.</p> |

### 6.2.32.2 Configuration options

| Type | Macro                | Default | Description    |
|------|----------------------|---------|----------------|
| N    | WHEEL_PERIOD_DEFAULT | 300     | Motion period. |

### 6.2.32.3 Predefined IDs

The following symbols define IDs which may be used to make WHEEL widgets distinguishable from creation.

```
#define GUI_ID_WHEEL0      0x390
#define GUI_ID_WHEEL1      0x391
#define GUI_ID_WHEEL2      0x392
#define GUI_ID_WHEEL3      0x393
#define GUI_ID_WHEEL4      0x394
#define GUI_ID_WHEEL5      0x395
#define GUI_ID_WHEEL6      0x396
#define GUI_ID_WHEEL7      0x397
#define GUI_ID_WHEEL8      0x398
#define GUI_ID_WHEEL9      0x399
```

### 6.2.32.4 Notification codes

The following events are sent from a WHEEL widget to its parent window as part of a WM\_NOTIFY\_PARENT message:

| Message                     | Description                         |
|-----------------------------|-------------------------------------|
| WM_NOTIFICATION_CLICKED     | WHEEL has been clicked.             |
| WM_NOTIFICATION_RELEASED    | WHEEL has been released.            |
| WM_NOTIFICATION_SEL_CHANGED | Selection of the WHEEL has changed. |

### 6.2.32.5 WHEEL API

The table below lists the available emWin WHEEL-related routines in alphabetical order. Detailed descriptions of the routines follow.

#### Functions

| Routine                  | Description   |
|--------------------------|---|
| WHEEL_AddBitmaps()       | Adds a new list of bitmaps to the WHEEL.  |
| WHEEL_AddText()          | Adds a new list of texts to the WHEEL.  |
| WHEEL_ClrCenterBox()     | Disables the center box for the WHEEL widget.   |
| WHEEL_ClrCenterBitmaps() | Removes the given list of center bitmaps.   |
| WHEEL_ClrCenterText()    | Clears the center properties set to the given text list.                                    |
| WHEEL_CreateEx()         | Creates a WHEEL widget of a specified size at a specified location.                         |
| WHEEL_CreateIndirect()   | Creates a WHEEL widget from a resource table entry.   |
| WHEEL_CreateUser()       | Creates a WHEEL widget of a specified size at a specified location with optional user data. |
| WHEEL_GetItemText()      | Retrieves a given item text.  |
| WHEEL_GetReleasedItem()  | Returns the index of the last released item of the WHEEL.                                   |



| Routine                                     | Description   |
|---|---|
| <code>WHEEL_GetSel()</code>                 | Returns the index of the selected item.   |
| <code>WHEEL_GetUserData()</code>            | Retrieves the extra data of a WHEEL widget.   |
| <code>WHEEL_IsMoving()</code>               | Returns if the WHEEL is currently moving by an animation or motion input.                                       |
| <code>WHEEL_MoveToPos()</code>              | Moves the WHEEL to the position of a given index using an animation with default period.                        |
| <code>WHEEL_SetBkColor()</code>             | Sets the background color for the WHEEL.  |
| <code>WHEEL_SetBox()</code>                 | Sets the properties how all the boxes of all items are drawn.   |
| <code>WHEEL_SetCenterBitmaps()</code>       | Adds the given list of bitmaps to the WHEEL and sets it as center bitmaps.                                      |
| <code>WHEEL_SetCenterBox()</code>           | Enables a center box for the WHEEL and sets the properties for the center box.                                  |
| <code>WHEEL_SetHBorder()</code>             | Sets a horizontal border for all items.   |
| <code>WHEEL_SetItemText()</code>            | Sets a string in a given text list of the WHEEL.  |
| <code>WHEEL_SetMode()</code>                | Sets the mode of the WHEEL widget.  |
| <code>WHEEL_SetOverlay()</code>             | Sets an overlay bitmap to the WHEEL.  |
| <code>WHEEL_SetOverlayColor()</code>        | Sets a color to the overlay bitmap set with <code>WHEEL_SetOverlay()</code> , if an alpha bitmap is being used. |
| <code>WHEEL_SetPeriod()</code>              | Sets the motion period for a WHEEL widget.  |
| <code>WHEEL_SetSel()</code>                 | Sets the selection to the given index.  |
| <code>WHEEL_SetUserData()</code>            | Sets the extra data of a WHEEL widget.  |
| "Morph mode"-only functions                 |   |
| <code>WHEEL_SetSizesMorph()</code>          | Sets the sizes of the cells in morph mode.  |
| <code>WHEEL_SetCellBitmapAttrMorph()</code> | Sets attributes for a bitmap list that is associated with non-center cells.                                     |
| <code>WHEEL_SetCenterTextAttrMorph()</code> | Sets the center text attributes of a given text list for morph mode.  |
| "Plain mode"-only functions                 |   |
| <code>WHEEL_SetCellColorPlain()</code>      | Sets the color of the boxes that are not in the center.   |
| <code>WHEEL_SetCenterColorPlain()</code>    | Sets the color of the center box.   |
| <code>WHEEL_SetCenterTextAttrPlain()</code> | Sets the center text attributes of a given text list for plain mode.  |
| <code>WHEEL_SetSizesPlain()</code>          | Sets the sizes of the cells in plain mode.  |

## Defines

| Group of defines                   | Description   |
|------------------------------------|---|
| <code>WHEEL create flags</code>    | WHEEL create flags to be used in the create functions.          |
| <code>WHEEL mode flags</code>      | WHEEL mode flags to select the widget's mode.                   |
| <code>WHEEL overlay indexes</code> | WHEEL overlay indexes to be used for overlay related functions. |



## 6.2.32.5.1 Functions

### 6.2.32.5.1.1 WHEEL\_AddBitmaps()

#### Description

Adds a new list of bitmaps to the WHEEL.

#### Prototype

```
int WHEEL_AddBitmaps(    WHEEL_Handle    hObj,
                        const GUI_BITMAP  ** ppBitmap,
                        unsigned          NumItems,
                        U8                Align,
                        I16               xOff,
                        I16               yOff,
                        GUI_COLOR         Color);
```

#### Parameters

| Parameter                | Description   |
|--------------------------|---|
| <a href="#">hObj</a>     | Handle of WHEEL widget.   |
| <a href="#">ppBitmap</a> | <a href="#">in</a> Pointer to an array of <code>GUI_BITMAP</code> structures. |
| <a href="#">NumItems</a> | Number of items in array pointed to by <a href="#">ppBitmap</a> .             |
| <a href="#">Align</a>    | Alignment to be used for the bitmaps.   |
| <a href="#">xOff</a>     | X-offset for the alignment in pixels.   |
| <a href="#">yOff</a>     | Y-offset for the alignment in pixels.   |
| <a href="#">Color</a>    | <code>Color</code> to be used for alpha bitmaps.                              |

#### Return value

= -1     On error.  
 ≠ -1     Index of newly added bitmap list.

### 6.2.32.5.1.2 WHEEL\_AddText()

#### Description

Adds a new list of texts to the WHEEL.

#### Prototype

```
int WHEEL_AddText(      WHEEL_Handle      hObj,
                       const GUI_ConstString * ppText,
                       unsigned           NumItems,
                       U8                 Align,
                       I16                 xOff,
                       I16                 yOff,
                       GUI_COLOR          Color,
                       const GUI_FONT     * pFont);
```

#### Parameters

| Parameter             | Description   |
|-----------------------|---|
| <code>hObj</code>     | Handle of WHEEL widget.   |
| <code>ppText</code>   | <b>in</b> Pointer to an array of string pointers containing the elements to be displayed. |
| <code>NumItems</code> | Number of items in the array <code>ppText</code> .  |
| <code>Align</code>    | Alignment of the texts.   |
| <code>xOff</code>     | X-offset to the alignment in pixels.  |
| <code>yOff</code>     | Y-offset to the alignment in pixels.  |
| <code>Color</code>    | Text color to be used.  |
| <code>pFont</code>    | <b>in</b> Font to be used.  |

#### Return value

= -1     On error.  
 ≠ -1     Index of newly added text list.

### 6.2.32.5.1.3 WHEEL\_ClrCenterBox()

#### Description

Disables the center box for the WHEEL widget. The properties set with `WHEEL_SetBox()` will be used for the center box.

#### Prototype

```
void WHEEL_ClrCenterBox(WHEEL_Handle hObj);
```

#### Parameters

| Parameter         | Description             |
|-------------------|-------------------------|
| <code>hObj</code> | Handle of WHEEL widget. |

#### 6.2.32.5.1.4 WHEEL\_ClrCenterBitmaps()

##### Description

Removes the given list of center bitmaps.

##### Prototype

```
void WHEEL_ClrCenterBitmaps(WHEEL_Handle hObj,  
                             unsigned      Index);
```

##### Parameters

| Parameter             | Description   |
|-----------------------|---|
| <a href="#">hObj</a>  | Handle of WHEEL widget.                                 |
| <a href="#">Index</a> | <a href="#">Index</a> of the bitmap list to be removed. |

### 6.2.32.5.1.5 WHEEL\_ClrCenterText()

#### Description

Clears the center properties set to the given text list.

#### Prototype

```
void WHEEL_ClrCenterText(WHEEL_Handle hObj,  
                        unsigned Index);
```

#### Parameters

| Parameter             | Description                             |
|-----------------------|---|
| <a href="#">hObj</a>  | Handle of WHEEL widget.                 |
| <a href="#">Index</a> | <a href="#">Index</a> of the text list. |

### 6.2.32.5.1.6 WHEEL\_CreateEx()

#### Description

Creates a WHEEL widget of a specified size at a specified location.

#### Prototype

```
WHEEL_Handle WHEEL_CreateEx(int    x0,
                             int    y0,
                             int    xSize,
                             int    ySize,
                             WM_HWIN hParent,
                             int    WinFlags,
                             int    ExFlags,
                             int    Id);
```

#### Parameters

| Parameter             | Description  |
|-----------------------|--|
| <code>x0</code>       | Leftmost pixel of the widget (in parent coordinates).  |
| <code>y0</code>       | Topmost pixel of the widget (in parent coordinates).   |
| <code>xSize</code>    | Horizontal size of the widget (in pixels).   |
| <code>ySize</code>    | Vertical size of the widget (in pixels).   |
| <code>NumItems</code> | Number of items of the WHEEL.  |
| <code>hParent</code>  | Handle of parent window. If 0, the new WHEEL widget will be a child of the desktop (top-level window).   |
| <code>WinFlags</code> | Window create flags. Typically <code>WM_CF_SHOW</code> in order to make the widget visible immediately (refer to <i>Window create flags</i> on page 977 for a list of available parameter values). |
| <code>ExFlags</code>  | OR-combination of special creation flags. See <i>WHEEL create flags</i> on page 2346 for a list of permitted values.   |
| <code>Id</code>       | Window ID of the widget.   |

#### Return value

- = 0      Creation of the WHEEL failed.
- ≠ 0     Handle of the created WHEEL widget.



### 6.2.32.5.1.7 WHEEL\_CreateIndirect()

#### Description

Prototype explained at the beginning of the chapter as `<WIDGET>_CreateIndirect()` on page 992.

### 6.2.32.5.1.8 WHEEL\_CreateUser()

#### Description

Creates a WHEEL widget of a specified size at a specified location with optional user data.

#### Prototype

```
WHEEL_Handle WHEEL_CreateUser(int    x0,
                               int    y0,
                               int    xSize,
                               int    ySize,
                               WM_HWIN hParent,
                               int    WinFlags,
                               int    ExFlags,
                               int    Id,
                               int    NumExtraBytes);
```

#### Parameters

| Parameter                  | Description  |
|----------------------------|--|
| <code>x0</code>            | Leftmost pixel of the widget (in parent coordinates).  |
| <code>y0</code>            | Topmost pixel of the widget (in parent coordinates).   |
| <code>xSize</code>         | Horizontal size of the widget (in pixels).   |
| <code>ySize</code>         | Vertical size of the widget (in pixels).   |
| <code>NumItems</code>      | Number of items of the WHEEL.  |
| <code>hParent</code>       | Handle of parent window. If 0, the new WHEEL widget will be a child of the desktop (top-level window).   |
| <code>WinFlags</code>      | Window create flags. Typically <code>WM_CF_SHOW</code> in order to make the widget visible immediately (refer to <i>Window create flags</i> on page 977 for a list of available parameter values). |
| <code>ExFlags</code>       | OR-combination of special creation flags. See <i>WHEEL create flags</i> on page 2346 for a list of permitted values.   |
| <code>Id</code>            | Window ID of the widget.   |
| <code>NumExtraBytes</code> | Number of additional bytes to be allocated for user data.  |

### 6.2.32.5.1.9 WHEEL\_GetDefaultPeriod()

#### Description

Returns the default period that is used for newly created WHEEL widgets.

#### Prototype

```
int WHEEL_GetDefaultPeriod(void);
```

#### Return value

Default period for new WHEEL widgets.

### 6.2.32.5.1.10 WHEEL\_GetItemText()

#### Description

Retrieves a given item text.

#### Prototype

```
int WHEEL_GetItemText(WHEEL_Handle hObj,
                     unsigned Index,
                     unsigned Row,
                     char * pBuffer,
                     int MaxLen);
```

#### Parameters

| Parameter              | Description   |
|------------------------|---|
| <code>hObj</code>      | Handle of WHEEL widget.                               |
| <code>IndexText</code> | Index of the text list.                               |
| <code>IndexItem</code> | Index of the item in the text list.                   |
| <code>pBuffer</code>   | <b>out</b> Pointer to a char array to store the text. |
| <code>MaxLen</code>    | Size of the buffer.                                   |

#### Return value

0 On success.  
1 On error.

### 6.2.32.5.1.11 WHEEL\_DelItemText()

#### Description

Deletes a given text from a text list.

#### Prototype

```
int WHEEL_DelItemText(WHEEL_Handle hObj,  
                     unsigned      Index,  
                     unsigned      Row);
```

#### Parameters

| Parameter             | Description                                       |
|-----------------------|---|
| <a href="#">hObj</a>  | Handle of WHEEL widget.                           |
| <a href="#">Index</a> | <a href="#">Index</a> of text list.               |
| <a href="#">Row</a>   | <a href="#">Index</a> of text item to be deleted. |

#### Return value

0        On success.  
1        On error.

### 6.2.32.5.1.12 WHEEL\_GetItemText()

#### Description

Retrieves a given item text.

#### Prototype

```
int WHEEL_GetItemText(WHEEL_Handle hObj,  
                     unsigned Index,  
                     unsigned Row,  
                     char * pBuffer,  
                     int MaxLen);
```

#### Parameters

| Parameter              | Description   |
|------------------------|---|
| <code>hObj</code>      | Handle of WHEEL widget.                               |
| <code>IndexText</code> | Index of the text list.                               |
| <code>IndexItem</code> | Index of the item in the text list.                   |
| <code>pBuffer</code>   | <b>out</b> Pointer to a char array to store the text. |
| <code>MaxLen</code>    | Size of the buffer.                                   |

#### Return value

0 On success.  
1 On error.

### 6.2.32.5.1.13 WHEEL\_GetNumText()

#### Description

Returns the number of text lists.

#### Prototype

```
int WHEEL_GetNumText(WHEEL_Handle hObj);
```

#### Parameters

| Parameter            | Description             |
|----------------------|-------------------------|
| <a href="#">hObj</a> | Handle of WHEEL widget. |

#### Return value

Number of text lists added to the WHEEL.

#### 6.2.32.5.1.14 WHEEL\_GetNumTextItems()

##### Description

Returns the number text items that are present in a text list.

##### Prototype

```
int WHEEL_GetNumTextItems(WHEEL_Handle hObj,  
                           unsigned      Index);
```

##### Parameters

| Parameter             | Description                             |
|-----------------------|---|
| <a href="#">hObj</a>  | Handle of WHEEL widget.                 |
| <a href="#">Index</a> | <a href="#">Index</a> of the text list. |

##### Return value

Number of text items in the given text list.



### 6.2.32.5.1.15 WHEEL\_GetReleasedItem()

#### Description

Returns the index of the last released item of the WHEEL.

#### Prototype

```
int WHEEL_GetReleasedItem(WHEEL_Handle hObj);
```

#### Parameters

| Parameter            | Description             |
|----------------------|-------------------------|
| <a href="#">hObj</a> | Handle of WHEEL widget. |

#### Return value

Index of last released item.

### 6.2.32.5.1.16 WHEEL\_GetSel()

#### Description

Returns the index of the selected item. The selected item is the item that is currently in the center of the WHEEL.

#### Prototype

```
int WHEEL_GetSel(WHEEL_Handle hObj);
```

#### Parameters

| Parameter         | Description             |
|-------------------|-------------------------|
| <code>hObj</code> | Handle of WHEEL widget. |

#### Return value

Index of the selected item.

### 6.2.32.5.1.17 WHEEL\_GetUserData()

#### Description

Prototype explained at the beginning of the chapter as `<WIDGET>_GetUserData()` on page 994.

### 6.2.32.5.1.18 WHEEL\_InsertItemText()

#### Description

Adds a new text to an existing text list.

#### Prototype

```
int WHEEL_InsertItemText(    WHEEL_Handle  hObj,  
                            unsigned        Index,  
                            unsigned        Row,  
                            const char     * s);
```

#### Parameters

| Parameter             | Description   |
|-----------------------|---|
| <a href="#">hObj</a>  | Handle of WHEEL widget.                                 |
| <a href="#">Index</a> | <a href="#">Index</a> of text list.                     |
| <a href="#">Row</a>   | <a href="#">Row</a> position to insert the string into. |
| <a href="#">s</a>     | <a href="#">in</a> Pointer to string to be inserted.    |

#### Return value

- 0 On success.
- 1 On error.

### 6.2.32.5.1.19 WHEEL\_IsMoving()

#### Description

Returns if the WHEEL is currently moving by an animation or motion input.

#### Prototype

```
int WHEEL_IsMoving(WHEEL_Handle hObj);
```

#### Parameters

| Parameter            | Description             |
|----------------------|-------------------------|
| <a href="#">hObj</a> | Handle of WHEEL widget. |

#### Return value

- 0 WHEEL is not moving.
- 1 WHEEL is moving.

### 6.2.32.5.1.20 WHEEL\_MoveToPos()

#### Description

Moves the WHEEL to the position of a given index using an animation with default period.

#### Prototype

```
void WHEEL_MoveToPos(WHEEL_Handle hObj,  
                    int Index);
```

#### Parameters

| Parameter             | Description                               |
|-----------------------|---|
| <a href="#">hObj</a>  | Handle of WHEEL widget.                   |
| <a href="#">Index</a> | <a href="#">Index</a> of item to move to. |

### 6.2.32.5.1.21 WHEEL\_MoveToPosEx()

#### Description

Moves the WHEEL to the position of a given index using an animation with given period.

#### Prototype

```
void WHEEL_MoveToPosEx(WHEEL_Handle hObj,  
                       int          Index,  
                       U32          Period);
```

#### Parameters

| Parameter              | Description  |
|------------------------|--|
| <a href="#">hObj</a>   | Handle of WHEEL widget.                                |
| <a href="#">Index</a>  | <a href="#">Index</a> of item to move to.              |
| <a href="#">Period</a> | <a href="#">Period</a> in ms for the moving animation. |

### 6.2.32.5.1.22 WHEEL\_SetAlign()

#### Description

Sets the alignment of a WHEEL widget.

#### Prototype

```
void WHEEL_SetAlign(WHEEL_Handle hObj,  
                   U8           Align);
```

#### Parameters

| Parameter             | Description             |
|-----------------------|-------------------------|
| <a href="#">hObj</a>  | Handle of WHEEL widget. |
| <a href="#">Align</a> | New alignment.          |



### 6.2.32.5.1.23 WHEEL\_SetBkColor()

#### Description

Sets the background color for the WHEEL.

#### Prototype

```
void WHEEL_SetBkColor(WHEEL_Handle hObj,  
                     GUI_COLOR   BkColor);
```

#### Parameters

| Parameter            | Description                            |
|----------------------|--|
| <code>hObj</code>    | Handle of WHEEL widget.                |
| <code>BkColor</code> | Background color for the WHEEL widget. |

### 6.2.32.5.1.24 WHEEL\_SetBox()

#### Description

Sets the properties how all the boxes of all items are drawn.

#### Prototype

```
void WHEEL_SetBox(WHEEL_Handle hObj,  
                  GUI_COLOR   Color,  
                  GUI_COLOR   FrameColor,  
                  U8           FrameRadius,  
                  U8           FrameSize);
```

#### Parameters

| Parameter                | Description                 |
|--------------------------|-----------------------------|
| <code>hObj</code>        | Handle of WHEEL widget.     |
| <code>Color</code>       | Fill color of the box.      |
| <code>FrameColor</code>  | Frame color of the box.     |
| <code>FrameRadius</code> | Radius of the box.          |
| <code>FrameSize</code>   | Frame thickness of the box. |

### 6.2.32.5.1.25 WHEEL\_SetCenterBitmapAttr()

#### Description

Sets the properties to the given center bitmaps.

#### Prototype

```
void WHEEL_SetCenterBitmapAttr(WHEEL_Handle hObj,
                               unsigned      Index,
                               U8           Align,
                               I16         xOff,
                               I16         yOff,
                               GUI_COLOR    Color);
```

#### Parameters

| Parameter          | Description   |
|--------------------|---|
| <code>hObj</code>  | Handle of WHEEL widget.   |
| <code>Index</code> | <code>Index</code> of the bitmap list.                                |
| <code>Align</code> | New bitmap alignment to be set.                                       |
| <code>xOff</code>  | x-Offset to the alignment of the bitmap.                              |
| <code>yOff</code>  | y-Offset to the alignment of the bitmap.                              |
| <code>Color</code> | <code>Color</code> to be used by the bitmap (only for alpha bitmaps). |

### 6.2.32.5.1.26 WHEEL\_SetCenterBitmaps()

#### Description

Adds the given list of bitmaps to the WHEEL and sets it as center bitmaps. This means they will only be displayed in the center cell.

#### Prototype

```
void WHEEL_SetCenterBitmaps(    WHEEL_Handle    hObj,
                               unsigned              Index,
                               const GUI_BITMAP     ** ppBitmap,
                               unsigned              NumItems,
                               U8                    Align,
                               I16                    xOff,
                               I16                    yOff,
                               GUI_COLOR             Color);
```

#### Parameters

| Parameter             | Description   |
|-----------------------|---|
| <code>hObj</code>     | Handle of WHEEL widget.   |
| <code>Index</code>    | Zero-based index of non-center bitmap list this center bitmap list should be associated with. |
| <code>ppBitmap</code> | <b>in</b> Pointer to array of <code>GUI_BITMAP</code> pointers to be added.                   |
| <code>NumItems</code> | Number of items in the list pointed to by <code>ppBitmap</code> .                             |
| <code>Align</code>    | Alignment to be used for the bitmaps.   |
| <code>xOff</code>     | x-Offset to the alignment.  |
| <code>yOff</code>     | y-Offset to the alignment.  |
| <code>Color</code>    | <code>Color</code> to be used for the bitmaps (only for alpha bitmaps).                       |

### 6.2.32.5.1.27 WHEEL\_SetCenterBox()

#### Description

Enables a center box for the WHEEL and sets the properties for the center box.

#### Prototype

```
void WHEEL_SetCenterBox(WHEEL_Handle hObj,
                        GUI_COLOR    Color,
                        GUI_COLOR    FrameColor,
                        U8           FrameRadius,
                        U8           FrameSize);
```

#### Parameters

| Parameter                | Description                        |
|--------------------------|------------------------------------|
| <code>hObj</code>        | Handle of WHEEL widget.            |
| <code>Color</code>       | Fill color of the center box.      |
| <code>FrameColor</code>  | Frame color of the center box.     |
| <code>FrameRadius</code> | Radius of the center box.          |
| <code>FrameSize</code>   | Frame thickness of the center box. |

### 6.2.32.5.1.28 WHEEL\_SetCenterColorPlain()

#### Description

Sets the color of the center box. This function is to be used if the WHEEL is in plain mode.

#### Prototype

```
void WHEEL_SetCenterColorPlain(WHEEL_Handle hObj,  
                               GUI_COLOR   Color);
```

#### Parameters

| Parameter             | Description             |
|-----------------------|-------------------------|
| <a href="#">hObj</a>  | Handle of WHEEL widget. |
| <a href="#">Color</a> | New color.              |

### 6.2.32.5.1.29 WHEEL\_SetCellBitmapAttrMorph()

#### Description

Sets attributes for a bitmap list that is associated with non-center cells. Only to be used for WHEELs in morph mode.

#### Prototype

```
void WHEEL_SetCellBitmapAttrMorph(WHEEL_Handle hObj,
                                   unsigned      Index,
                                   U8           Align,
                                   I16          xOff,
                                   I16          yOff,
                                   GUI_COLOR    Color);
```

#### Parameters

| Parameter          | Description   |
|--------------------|---|
| <code>hObj</code>  | Handle of WHEEL widget.                                 |
| <code>Index</code> | Zero-based index of bitmap list.                        |
| <code>Align</code> | New alignment to be set for the bitmaps.                |
| <code>xOff</code>  | x-Offset to the alignment.                              |
| <code>yOff</code>  | y-Offset to the alignment.                              |
| <code>Color</code> | <code>Color</code> to be used (only for alpha bitmaps). |

### 6.2.32.5.1.30 WHEEL\_SetCellColorPlain()

#### Description

Sets the color of the boxes that are not in the center. This function is to be used if the WHEEL is in plain mode.

#### Prototype

```
void WHEEL_SetCellColorPlain(WHEEL_Handle hObj,  
                             GUI_COLOR    Color);
```

#### Parameters

| Parameter          | Description             |
|--------------------|-------------------------|
| <code>hObj</code>  | Handle of WHEEL widget. |
| <code>Color</code> | New color.              |



### 6.2.32.5.1.31 WHEEL\_SetCenterTextAttrMorph()

#### Description

Sets the center text attributes of a given text list for morph mode.

#### Prototype

```
void WHEEL_SetCenterTextAttrMorph(WHEEL_Handle hObj,
                                   unsigned      Index,
                                   U8           Align,
                                   I16          xOff,
                                   I16          yOff,
                                   GUI_COLOR    Color);
```

#### Parameters

| Parameter          | Description                                  |
|--------------------|--|
| <code>hObj</code>  | Handle of WHEEL widget.                      |
| <code>Index</code> | Zero-based index of the text list.           |
| <code>Align</code> | Alignment to be used for the texts.          |
| <code>xOff</code>  | X-offset for the alignment in pixels.        |
| <code>yOff</code>  | Y-offset for the alignment in pixels.        |
| <code>Color</code> | <code>Color</code> to be used for the texts. |

### 6.2.32.5.1.32 WHEEL\_SetCenterTextAttrPlain()

#### Description

Sets the center text attributes of a given text list for plain mode.

#### Prototype

```
void WHEEL_SetCenterTextAttrPlain(    WHEEL_Handle   hObj,
                                     unsigned          Index,
                                     U8                 Align,
                                     I16                xOff,
                                     I16                yOff,
                                     GUI_COLOR          Color,
                                     const GUI_FONT     * pFont);
```

#### Parameters

| Parameter          | Description                                    |
|--------------------|--|
| <code>hObj</code>  | Handle of WHEEL widget.                        |
| <code>Index</code> | Zero-based index of the text list.             |
| <code>Align</code> | Alignment to be used for the texts.            |
| <code>xOff</code>  | X-offset for the alignment in pixels.          |
| <code>yOff</code>  | Y-offset for the alignment in pixels.          |
| <code>Color</code> | <code>Color</code> to be used for the texts.   |
| <code>pFont</code> | <code>in</code> Font to be used for the texts. |

### 6.2.32.5.1.33 WHEEL\_SetDefaultPeriod()

#### Description

Sets a default period that is used for newly created WHEEL widgets.

#### Prototype

```
void WHEEL_SetDefaultPeriod(int Period);
```

#### Parameters

| Parameter           | Description           |
|---------------------|-----------------------|
| <code>Period</code> | New period to be set. |

### 6.2.32.5.1.34 WHEEL\_SetHBorder()

#### Description

Sets a horizontal border for all items.

#### Prototype

```
void WHEEL_SetHBorder(WHEEL_Handle hObj,  
                     U16           HBorder);
```

#### Parameters

| Parameter               | Description                       |
|-------------------------|-----------------------------------|
| <a href="#">hObj</a>    | Handle of WHEEL widget.           |
| <a href="#">HBorder</a> | Horizontal border position in px. |

### 6.2.32.5.1.35 WHEEL\_SetItemText()

#### Description

Sets a string in a given text list of the WHEEL.

#### Prototype

```
int WHEEL_SetItemText(    WHEEL_Handle  hObj,
                        unsigned      Index,
                        unsigned      Row,
                        const char    * s);
```

#### Parameters

| Parameter              | Description                         |
|------------------------|-------------------------------------|
| <code>hObj</code>      | Handle of WHEEL widget.             |
| <code>IndexText</code> | Index of the text list.             |
| <code>IndexItem</code> | Index of the item in the text list. |
| <code>s</code>         | <b>in</b> Pointer to a string.      |

#### Return value

0        On success.  
1        On error.

### 6.2.32.5.1.36 WHEEL\_SetMode()

#### Description

Sets the mode of the WHEEL widget.

#### Prototype

```
void WHEEL_SetMode(WHEEL_Handle hObj,  
                  U16           Mode);
```

#### Parameters

| Parameter            | Description   |
|----------------------|---|
| <a href="#">hObj</a> | Handle of WHEEL widget.   |
| <a href="#">Mode</a> | OR-combination of mode flags, see <i>WHEEL mode flags</i> on page 2347. |

### 6.2.32.5.1.37 WHEEL\_SetOverlay()

#### Description

Sets an overlay bitmap to the WHEEL. The overlay is optional.

A total of three overlay bitmaps can be set which are drawn in the order determined by the [Index](#) parameter.

#### Prototype

```
void WHEEL_SetOverlay(    WHEEL_Handle    hObj,
                        unsigned          Index,
                        const GUI_BITMAP  * pBitmap,
                        U8                 Align,
                        I16                xOff,
                        I16                yOff);
```

#### Parameters

| Parameter               | Description                                    |
|-------------------------|--|
| <a href="#">hObj</a>    | Handle of WHEEL widget.                        |
| <a href="#">Index</a>   | See <i>WHEEL overlay indexes</i> on page 2348. |
| <a href="#">pBitmap</a> | <b>in</b> Pointer to GUI_BITMAP structure.     |
| <a href="#">Align</a>   | Alignment of the bitmap.                       |
| <a href="#">xOff</a>    | x-Offset to the alignment of the bitmap.       |
| <a href="#">yOff</a>    | y-Offset to the alignment of the bitmap.       |

### 6.2.32.5.1.38 WHEEL\_SetOverlayColor()

#### Description

Sets a color to the overlay bitmap set with `WHEEL_SetOverlay()`, if an alpha bitmap is being used.

#### Prototype

```
void WHEEL_SetOverlayColor(WHEEL_Handle hObj,  
                           unsigned      Index,  
                           GUI_COLOR     Color);
```

#### Parameters

| Parameter          | Description                                    |
|--------------------|--|
| <code>hObj</code>  | Handle of WHEEL widget.                        |
| <code>Index</code> | See <i>WHEEL overlay indexes</i> on page 2348. |
| <code>Color</code> | <code>Color</code> to be used.                 |



### 6.2.32.5.1.39 WHEEL\_SetPeriod()

#### Description

Sets the motion period for a WHEEL widget.

#### Prototype

```
void WHEEL_SetPeriod(WHEEL_Handle hObj,  
                    U32          Period);
```

#### Parameters

| Parameter           | Description             |
|---------------------|-------------------------|
| <code>hObj</code>   | Handle of WHEEL widget. |
| <code>Period</code> | New period.             |

#### 6.2.32.5.1.40 WHEEL\_SetSel()

##### Description

Sets the selection to the given index. The new selection will be in the center of the WHEEL.

##### Prototype

```
void WHEEL_SetSel(WHEEL_Handle hObj,  
                 int Index);
```

##### Parameters

| Parameter             | Description                                 |
|-----------------------|---|
| <a href="#">hObj</a>  | Handle of WHEEL widget.                     |
| <a href="#">Index</a> | <a href="#">Index</a> of new selected item. |

### 6.2.32.5.1.41 WHEEL\_SetSizesMorph()

#### Description

Sets the sizes of the cells in morph mode.

#### Prototype

```
void WHEEL_SetSizesMorph(WHEEL_Handle hObj,  
                          U16          CellSize,  
                          U16          CenterSize,  
                          U16          Cutaway,  
                          U8           AlignCutaway);
```

#### Parameters

| Parameter                    | Description  |
|------------------------------|--|
| <a href="#">hObj</a>         | Handle of WHEEL widget.  |
| <a href="#">CellSize</a>     | Size of non-center cells.  |
| <a href="#">CenterSize</a>   | Size of the center cell.   |
| <a href="#">Cutaway</a>      | Number of pixels that are cut away from non-center cells.          |
| <a href="#">AlignCutaway</a> | Alignment of non-center cells when <a href="#">Cutaway</a> is set. |

### 6.2.32.5.1.42 WHEEL\_SetSizesPlain()

#### Description

Sets the sizes of the cells in plain mode.

#### Prototype

```
void WHEEL_SetSizesPlain(WHEEL_Handle hObj,  
                        U16           CellSize,  
                        U16           CenterSize);
```

#### Parameters

| Parameter                  | Description               |
|----------------------------|---------------------------|
| <a href="#">hObj</a>       | Handle of WHEEL widget.   |
| <a href="#">CellSize</a>   | Size of non-center cells. |
| <a href="#">CenterSize</a> | Size of the center cell.  |

### 6.2.32.5.1.43 WHEEL\_SetUserData()

#### Description

Prototype explained at the beginning of the chapter as `<WIDGET>_SetUserData()` on page 995.

## 6.2.32.5.2 Defines

### 6.2.32.5.2.1 WHEEL create flags

#### Description

Flags that are passed when the WHEEL is created.

#### Definition

```
#define WHEEL_CF_HORIZONTAL    0
#define WHEEL_CF_VERTICAL     WIDGET_CF_VERTICAL
```

#### Symbols

| Definition                          | Description                   |
|-------------------------------------|-------------------------------|
| <a href="#">WHEEL_CF_HORIZONTAL</a> | The WHEEL moves horizontally. |
| <a href="#">WHEEL_CF_VERTICAL</a>   | The WHEEL moves vertically.   |

### 6.2.32.5.2 WHEEL mode flags

#### Description

Flags that define the movement behavior of the widget and the WHEEL's cells.

#### Definition

```
#define WHEEL_MODE_ENDLESS    0
#define WHEEL_MODE_STOP      WIDGET_STATE_USER0
#define WHEEL_MODE_PLAIN     0
#define WHEEL_MODE_MORPH     WIDGET_STATE_USER1
```

#### Symbols

| Definition                         | Description  |
|------------------------------------|--|
| <a href="#">WHEEL_MODE_ENDLESS</a> | The WHEEL's list moves continuously and does not stop when the end of the list has been reached.                                     |
| <a href="#">WHEEL_MODE_STOP</a>    | The WHEEL's list moves from the first element to the last one and stops when the last element has been reached.                      |
| <a href="#">WHEEL_MODE_PLAIN</a>   | Puts the WHEEL into plain mode. While the list is moving the items don't morph into one another, but the center item is highlighted. |
| <a href="#">WHEEL_MODE_MORPH</a>   | Puts the WHEEL into morph mode. While the list is moving one item morphs into the next item.   |

#### Additional information

A more detailed explanation of the WHEEL modes can be found at the beginning of the chapter.

### 6.2.32.5.2.3 WHEEL overlay indexes

#### Description

Indexes for the WHEEL's overlay bitmaps.

#### Definition

```
#define WHEEL_OI_FIRST      0
#define WHEEL_OI_SECOND    1
#define WHEEL_OI_THIRD     2
```

#### Symbols

| Definition                      | Description  |
|---------------------------------|--|
| <a href="#">WHEEL_OI_FIRST</a>  | First overlay bitmap that is drawn above the WHEEL.  |
| <a href="#">WHEEL_OI_SECOND</a> | Second overlay bitmap that is drawn above the WHEEL. |
| <a href="#">WHEEL_OI_THIRD</a>  | Third overlay bitmap that is drawn above the WHEEL.  |



## 6.2.33 WINDOW: Window widget

The WINDOW widget is used to create a dialog window from a resource table. It should be used if the dialog should not look like a frame window. The window widget acts as background and as a container for child windows: It can contain child windows and fills the background, typically with gray.

It behaves much like a frame-window without frame and title bar and is used for dialogs.

### Note

All WINDOW-related routines are located in the file(s) `WINDOW.c`, `DIALOG.h`.

### 6.2.33.1 Configuration options

| Type | Macro  | Default               | Description                                      |
|------|--|-----------------------|--|
| S    | WINDOW_BKCOLOR_DEFAULT<br>(with WIDGET_USE_FLEX_SKIN = 0)<br>(with WIDGET_USE_FLEX_SKIN = 1) | 0xC0C0C0<br>GUI_WHITE | Default background color for new WINDOW widgets. |

### 6.2.33.2 Keyboard reaction

The widget can not gain the input focus and does not react on keyboard input.

### 6.2.33.3 WINDOW API

The table below lists the available emWin WINDOW-related routines in alphabetical order. Detailed descriptions of the routines follow.

| Routine                                 | Description   |
|---|---|
| <code>WINDOW_CreateEx()</code>          | Creates a WINDOW widget.  |
| <code>WINDOW_CreateIndirect()</code>    | Creates a WINDOW widget from a resource table entry.            |
| <code>WINDOW_CreateUser()</code>        | Creates a WINDOW widget using extra bytes as user data.         |
| <code>WINDOW_GetUserData()</code>       | Retrieves the data set with <code>WINDOW_SetUserData()</code> . |
| <code>WINDOW_SetBkColor()</code>        | Sets the background color for the given WINDOW widget.          |
| <code>WINDOW_SetDefaultBkColor()</code> | Sets the default background color used for WINDOW widgets.      |
| <code>WINDOW_SetUserData()</code>       | Sets the extra data of a WINDOW widget.                         |

### 6.2.33.3.1 WINDOW\_CreateEx()

#### Description

Creates a WINDOW widget of a specified size at a specified location.

#### Prototype

```
WM_HWIN WINDOW_CreateEx(int          x0,
                        int          y0,
                        int          xSize,
                        int          ySize,
                        WM_HWIN      hParent,
                        int          WinFlags,
                        int          ExFlags,
                        int          Id,
                        WM_CALLBACK * cb);
```

#### Parameters

| Parameter             | Description  |
|-----------------------|--|
| <code>x0</code>       | Leftmost pixel of the WINDOW widget (in parent coordinates)  |
| <code>y0</code>       | Topmost pixel of the WINDOW widget (in parent coordinates)   |
| <code>xSize</code>    | Size of the WINDOW widget in X   |
| <code>ySize</code>    | Size of the WINDOW widget in Y   |
| <code>hParent</code>  | Handle of parent window  |
| <code>WinFlags</code> | Window create flags. Typically <code>WM_CF_SHOW</code> in order to make the widget visible immediately (refer to <i>Window create flags</i> on page 977 for a list of available parameter values). |
| <code>ExFlags</code>  | Not used yet, reserved for future use  |
| <code>Id</code>       | Window ID of the WINDOW widget   |
| <code>cb</code>       | Pointer to callback routine.   |

#### Return value

Handle of the created WINDOW widget; 0 if the function fails.

### 6.2.33.3.2 WINDOW\_CreateIndirect()

#### Description

The prototype of this function is explained at the beginning of this chapter. Details can be found in the description of the function `<WIDGET>_CreateIndirect()` on page 992. The element `Para` of the according `GUI_WIDGET_CREATE_INFO` structure is not used. The element `Flags` is used according to the parameter `WinFlags` of the function `WINDOW_CreateEx()`. The `Sample` folder contains the file `WIDGET_Window.c` which shows how to use the `WINDOW` widget in a dialog resource.

### 6.2.33.3.3 WINDOW\_CreateUser()

#### Description

Prototype explained at the beginning of the chapter as `<WIDGET>_CreateUser()` on page 993. For a detailed description of the parameters the function `WINDOW_CreateEx()` can be referred to.

#### 6.2.33.3.4 WINDOW\_GetUserData()

##### Description

Prototype explained at the beginning of the chapter as `<WIDGET>_GetUserData()` on page 994.

### 6.2.33.3.5 WINDOW\_SetBkColor()

#### Description

Sets the background color for the given WINDOW widget.

#### Prototype

```
void WINDOW_SetBkColor(WM_HWIN hObj,  
                       GUI_COLOR Color);
```

#### Parameters

| Parameter          | Description                  |
|--------------------|------------------------------|
| <code>hObj</code>  | Handle of the WINDOW widget. |
| <code>Color</code> | Background color to be used. |

### 6.2.33.3.6 WINDOW\_SetDefaultBkColor()

#### Description

Sets the default background color used for WINDOW widgets.

#### Prototype

```
void WINDOW_SetDefaultBkColor(GUI_COLOR Color);
```

#### Parameters

| Parameter | Description       |
|-----------|-------------------|
| Color     | Color to be used. |

### 6.2.33.3.7 WINDOW\_SetUserData()

#### Description

Prototype explained at the beginning of the chapter as `<WIDGET>_SetUserData()` on page 995.





## 6.2.34 Obsolete widgets

### 6.2.34.1 KNOB: Knob widget (obsolete)

#### Note

The KNOB widget is obsolete and has been replaced by the ROTARY widget!

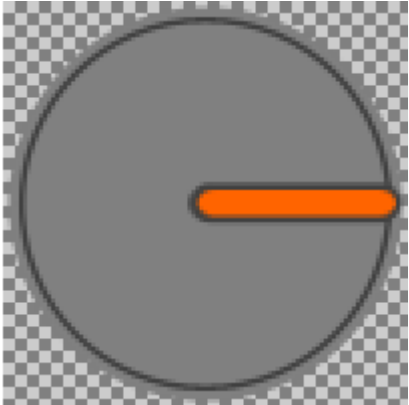
The KNOB widget is used to change a value with a knob. The KNOB widget is transparent per default and it requires a memory device containing a drawn knob to be visible. If the memory device contains transparency, any content can be shown in the background.

| Drawn knob with transparency   | How it appears used as KNOB widget  |
|--|---|
|  |  |

#### Note

All KNOB-related routines are in the file(s) `KNOB.c` and `KNOB.h`.  
All identifiers are prefixed with `KNOB`.

#### Ticks and Ticksize

A Tick describes the smallest range of movement of the KNOB widget. The smallest size of one Tick (Ticksize 1) equates 1/10 of a degree. So it takes 3600 Ticks to fulfill one round. The size of one Tick can be set with the function `KNOB_SetTickSize()`.

| Examples |                     |
|----------|---------------------|
| Ticksize | Ticks for one round |
| 60       | 60                  |
| 36       | 100                 |
| 300      | 12                  |

#### 6.2.34.1.1 Requirements

This widget requires the optional memory devices. Without the optional memory devices package the widget can not be used! The memory device which contains the drawn knob will not be deleted if the KNOB widget gets deleted. Make sure to delete the memory device by yourself if it is not any longer required.

#### Memory requirements

At least the widget uses two memory devices with a color depth of 32bpp (one with the drawn knob, one for internal use). The required amount of memory depends on using an additional memory device for the background or not. Detailed information on how to calculate memory requirements can be found in the chapter *Memory Devices* on page 2626.

Approximate memory usage without a background device: `XSIZE * 4 * YSIZE * 2`

### 6.2.34.1.2 Configuration options

| Type | Macro                              | Default                      | Description   |
|------|------------------------------------|------------------------------|---|
| N    | <code>KNOB_BKCOLOR_DEFAULT</code>  | <code>GUI_TRANSPARENT</code> | Background color  |
| N    | <code>KNOB_KEYVALUE_DEFAULT</code> | 1                            | Range the KNOB will rotate on one key press in 1/10 of degree.  |
| N    | <code>KNOB_OFFSET_DEFAULT</code>   | 0                            | An offset added to initial point of the KNOB in 1/10 of degree. |
| N    | <code>KNOB_PERIOD_DEFAULT</code>   | 1500                         | Time the KNOB takes to stop in ms.                              |
| N    | <code>KNOB_SNAP_DEFAULT</code>     | 0                            | Interval where the KNOB automatically stops in 1/10 of degree.  |
| N    | <code>KNOB_TICKSIZE_DEFAULT</code> | 1                            | Size of one tick in 1/10 of degree.                             |

### 6.2.34.1.3 Predefined IDs

The following symbols define IDs which may be used to make KNOB widgets distinguishable from creation.

```
#define GUI_ID_KNOB0    0x300
#define GUI_ID_KNOB1    0x301
#define GUI_ID_KNOB2    0x302
#define GUI_ID_KNOB3    0x303
#define GUI_ID_KNOB4    0x304
#define GUI_ID_KNOB5    0x305
#define GUI_ID_KNOB6    0x306
#define GUI_ID_KNOB7    0x307
#define GUI_ID_KNOB8    0x308
#define GUI_ID_KNOB9    0x309
```

### 6.2.34.1.4 Notification codes

The following events are sent from a KNOB widget to its parent window as part of a `WM_NOTIFY_PARENT` message:

| Message                                    | Description  |
|--|--|
| <code>WM_NOTIFICATION_CLICKED</code>       | KNOB has been clicked.   |
| <code>WM_NOTIFICATION_RELEASED</code>      | KNOB has been released.  |
| <code>WM_NOTIFICATION_MOVED_OUT</code>     | KNOB has been clicked and pointer has been moved out of the KNOB area without releasing. |
| <code>WM_NOTIFICATION_VALUE_CHANGED</code> | The value of the KNOB widget has been changed.   |

### 6.2.34.1.5 Keyboard reaction

The widget reacts to the following keys if it has the input focus:

| Key                        | Reaction              |
|----------------------------|-----------------------|
| <code>GUI_KEY_RIGHT</code> | The KNOB rotates CW.  |
| <code>GUI_KEY_LEFT</code>  | The KNOB rotates CCW. |
| <code>GUI_KEY_DOWN</code>  | The KNOB rotates CW.  |
| <code>GUI_KEY_UP</code>    | The KNOB rotates CCW. |

### 6.2.34.1.6 KNOB API

The table below lists the available emWin KNOB-related routines in alphabetical order. Detailed descriptions of the routines follow.

| Routine                               | Description   |
|---------------------------------------|---|
| <a href="#">KNOB_AddValue()</a>       | Adds a value to the position of the KNOB widget around its rotary axis.     |
| <a href="#">KNOB_CreateEx()</a>       | Creates a KNOB widget.  |
| <a href="#">KNOB_CreateIndirect()</a> | Creates a KNOB widget from a resource table entry.                          |
| <a href="#">KNOB_CreateUser()</a>     | Creates a KNOB widget using extra bytes as user data.                       |
| <a href="#">KNOB_GetUserData()</a>    | Retrieves the data set with <a href="#">KNOB_SetUserData()</a> .            |
| <a href="#">KNOB_GetValue()</a>       | Returns the current value of the KNOB widget.                               |
| <a href="#">KNOB_SetBkColor()</a>     | Sets a color for the background of the KNOB widget.                         |
| <a href="#">KNOB_SetBkDevice()</a>    | Sets a memory device to be shown as background.                             |
| <a href="#">KNOB_SetDevice()</a>      | Sets a memory device which contains a drawn knob.                           |
| <a href="#">KNOB_SetInvert()</a>      | Inverts the value of the knob.  |
| <a href="#">KNOB_SetKeyValue()</a>    | Sets a value which defines the movement range of the KNOB on one key press. |
| <a href="#">KNOB_SetOffset()</a>      | Sets an offset angle for the KNOB widget.                                   |
| <a href="#">KNOB_SetPeriod()</a>      | Sets a time period which defines how long the KNOB will need to stop.       |
| <a href="#">KNOB_SetPos()</a>         | Sets a new position for the KNOB widget around its rotary axis.             |
| <a href="#">KNOB_SetRange()</a>       | Sets a range within the KNOB can be rotated.                                |
| <a href="#">KNOB_SetRotateHQ()</a>    | Selects high quality rotating.  |
| <a href="#">KNOB_SetRotateLQ()</a>    | Selects low quality rotating.   |
| <a href="#">KNOB_SetSnap()</a>        | Sets a range between snap positions where the KNOB automatically stops.     |
| <a href="#">KNOB_SetTickSize()</a>    | Sets the size of one tick.  |
| <a href="#">KNOB_SetUserData()</a>    | Sets the extra data of a KNOB widget.                                       |

### 6.2.34.1.6.1 KNOB\_AddValue()

#### Description

Adds a value to the position of the KNOB widget around its rotary axis.

#### Prototype

```
void KNOB_AddValue(KNOB_Handle hObj,  
                  I32          Value);
```

#### Parameters

| Parameter          | Description   |
|--------------------|---|
| <code>hObj</code>  | Handle of the KNOB widget.  |
| <code>Value</code> | <code>Value</code> to be added to the position around the rotary axis in ticks. |

#### Additional information

A positive `Value` rotates the knob counter-clockwise and a negative `Value` clockwise.

### 6.2.34.1.6.2 KNOB\_CreateEx()

#### Description

Creates a KNOB widget of a specified size at a specified location with the possibility to assign a parent window.

#### Prototype

```
KNOB_Handle KNOB_CreateEx(int    x0,
                          int    y0,
                          int    xSize,
                          int    ySize,
                          WM_HWIN hParent,
                          int    WinFlags,
                          int    Id);
```

#### Parameters

| Parameter             | Description  |
|-----------------------|--|
| <code>x0</code>       | Leftmost pixel of the KNOB widget (in parent coordinates).   |
| <code>y0</code>       | Topmost pixel of the KNOB widget (in parent coordinates).  |
| <code>xSize</code>    | Horizontal size of the KNOB widget (in pixels).  |
| <code>ySize</code>    | Vertical size of the KNOB widget (in pixels).  |
| <code>hParent</code>  | Parent window of the KNOB widget.  |
| <code>Id</code>       | ID of the KNOB widget.   |
| <code>WinFlags</code> | Window create flags. Typically <code>WM_CF_SHOW</code> in order to make the widget visible immediately (refer to <i>Window create flags</i> on page 977 for a list of available parameter values). |

#### Return value

Handle of the created KNOB widget.

#### Additional information

The created widget is not visible by default. In order to have the widget being drawn a Memory Device needs to be set first. Using the function `KNOB_SetDevice()` a Memory Device containing the actual knob can be set.

### 6.2.34.1.6.3 KNOB\_CreateIndirect()

#### Description

Prototype explained at the beginning of the chapter as `<WIDGET>_CreateIndirect()` on page 992. The elements `Flags` and `Para` of the resource passed as parameter are not used.

#### 6.2.34.1.6.4 KNOB\_CreateUser()

##### Description

Prototype explained at the beginning of the chapter as `<WIDGET>_CreateUser()` on page 993. For a detailed description of the parameters the function `KNOB_CreateEx()` can be referred to.

### 6.2.34.1.6.5 KNOB\_GetUserData()

#### Description

Prototype explained at the beginning of the chapter as `<WIDGET>_GetUserData()` on page 994.



### 6.2.34.1.6.6 KNOB\_GetValue()

#### Description

Returns the value of the current position around its rotary axis.

#### Prototype

```
I32 KNOB_GetValue(KNOB_Handle hObj);
```

#### Parameters

| Parameter            | Description            |
|----------------------|------------------------|
| <a href="#">hObj</a> | Handle of KNOB widget. |

#### Return value

Value of the current position of the KNOB around its rotary axis in 1/10 of a degree.

#### Additional information

The value describes the angle in relation to the starting point. The starting point is defined by the offset which is set using the function `KNOB_SetOffset()`. Depending on the configured range (`KNOB_SetRange()`) the returned value might be more than 3600.

### 6.2.34.1.6.7 KNOB\_SetBkColor()

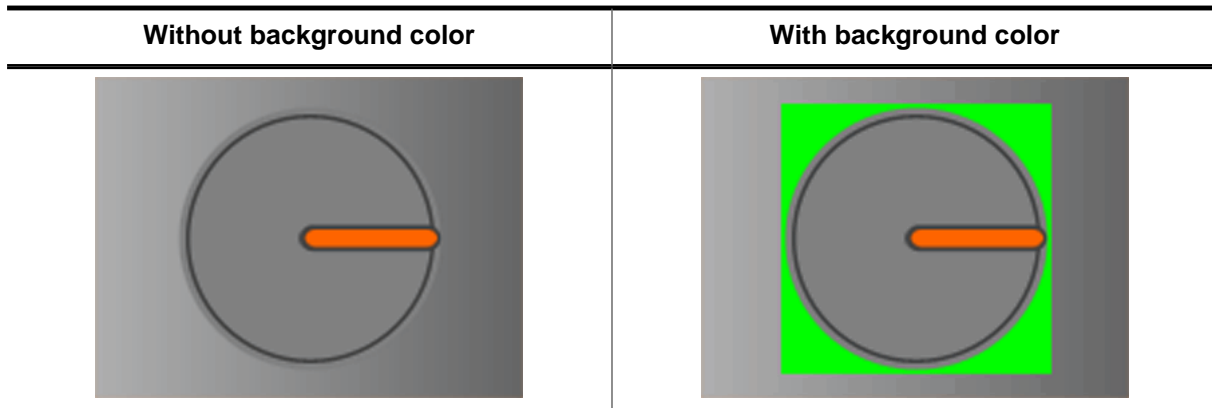

#### Description

Sets a color for the background of the KNOB widget.

#### Prototype

```
void KNOB_SetBkColor(KNOB_Handle hObj,
                    GUI_COLOR   BkColor);
```

#### Parameters

| Parameter | Description                          |
|-----------|--------------------------------------|
| hObj      | Handle of KNOB widget.               |
| Color     | Color to be set as background color. |

#### Additional information

Default color is transparent. It is not possible to set semi-transparent colors, only opaque colors are allowed.

### 6.2.34.1.6.8 KNOB\_SetBkDevice()

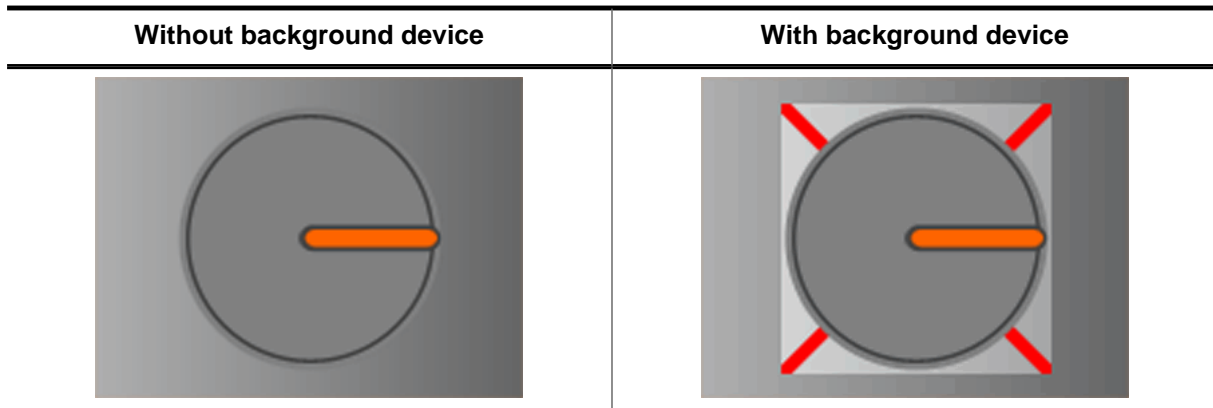

#### Description

Sets a memory device to be shown as background.

#### Prototype

```
void KNOB_SetBkDevice(KNOB_Handle      hObj,
                     GUI_MEMDEV_Handle hMemBk);
```

#### Parameters

| Parameter              | Description   |
|------------------------|---|
| <a href="#">hObj</a>   | Handle of KNOB widget.  |
| <a href="#">hMemBk</a> | Handle of a memory device which should be used as background. |

#### Additional information

The widget will not delete the background device if the widget gets deleted. So make sure to delete the background device by yourself.

### 6.2.34.1.6.9 KNOB\_SetDevice()

#### Description

Sets a memory device which contains a drawn knob. This drawing defines the appearance of the knob.

#### Prototype

```
void KNOB_SetDevice(KNOB_Handle      hObj,  
                   GUI_MEMDEV_Handle hMemSrc);
```

#### Parameters

| Parameter               | Description   |
|-------------------------|---|
| <a href="#">hObj</a>    | Handle of KNOB widget.  |
| <a href="#">hMemSrc</a> | Handle of a memory device which is used for the appearance of the KNOB. |

#### Additional information

The memory device must have a color depth of 32bpp. Without setting a memory device the KNOB will be invisible.

### 6.2.34.1.6.10 KNOB\_SetInvert()

#### Description

Inverts the output and input value for the KNOB widget.

#### Prototype

```
void KNOB_SetInvert(KNOB_Handle hObj,  
                   U8          Invert);
```

#### Parameters

| Parameter           | Description                                |
|---------------------|--|
| <code>hObj</code>   | Handle of KNOB widget.                     |
| <code>Invert</code> | Enables or disables invert. Can be 1 or 0. |

### 6.2.34.1.6.11 KNOB\_SetKeyValue()

#### Description

Sets a value which defines the movement range of the KNOB on one key press.

#### Prototype

```
void KNOB_SetKeyValue(KNOB_Handle hObj,  
                     I32          KeyValue);
```

#### Parameters

| Parameter                | Description   |
|--------------------------|---|
| <a href="#">hObj</a>     | Handle of KNOB widget.  |
| <a href="#">KeyValue</a> | Value is used for the movement range on one key press.<br>Unit is 1/10 of a degree. |

#### Additional information

If a tick size larger than 1 is set the KNOB widget uses the tick size as [KeyValue](#). This function is used only if no tick size is set.

### 6.2.34.1.6.12 KNOB\_SetOffset()

#### Description

Sets an offset angle for the KNOB widget. The knob will appear rotated from the beginning of the application.

#### Prototype

```
void KNOB_SetOffset(KNOB_Handle hObj,  
                   I32          Offset);
```

#### Parameters

| Parameter           | Description  |
|---------------------|--|
| <code>hObj</code>   | Handle of KNOB widget.   |
| <code>Offset</code> | <code>Offset</code> position of the knob around its rotary axis in 1/10 of a degree. |

### 6.2.34.1.6.13 KNOB\_SetPeriod()

#### Description

Sets a time period which defines how long the KNOB will need to stop.

#### Prototype

```
void KNOB_SetPeriod(KNOB_Handle hObj,  
                   I32          Period);
```

#### Parameters

| Parameter           | Description                           |
|---------------------|---------------------------------------|
| <code>hObj</code>   | Handle of KNOB widget.                |
| <code>Period</code> | Time it takes to stop the KNOB in ms. |

#### Additional information

The period can not be larger than 46340ms. Default is 1500ms.



### 6.2.34.1.6.14 KNOB\_SetPos()

#### Description

Sets a new position for the KNOB widget around its rotary axis.

#### Prototype

```
void KNOB_SetPos(KNOB_Handle hObj,  
                I32          Pos);
```

#### Parameters

| Parameter            | Description                                   |
|----------------------|---|
| <a href="#">hObj</a> | Handle of KNOB widget.                        |
| <a href="#">Pos</a>  | New position around the rotary axis in ticks. |

### 6.2.34.1.6.15 KNOB\_SetRange()

#### Description

Sets a range within the KNOB can be rotated.

#### Prototype

```
void KNOB_SetRange(KNOB_Handle hObj,
                  I32          MinRange,
                  I32          MaxRange);
```

#### Parameters

| Parameter                | Description   |
|--------------------------|---|
| <a href="#">hObj</a>     | Handle of KNOB widget.  |
| <a href="#">MinRange</a> | The minimum of the movement range in ticks. This value defines the distance from the starting point to the minimum value which can be reached by rotating the KNOB widget clockwise. <a href="#">MinRange</a> defines the range to move clockwise. <a href="#">MaxRange</a> defines the range to move counterclockwise. |
| <a href="#">MaxRange</a> | The maximum of the movement range in ticks. This value defines the distance from the starting point to the maximum value which can be reached by rotating the KNOB widget counterclockwise.   |

#### Additional information

The difference between [MinRange](#) and [MaxRange](#) defines the movement area. If the `TICK-Size` is set to 10 and [MinRange](#) is set to 0 and [MaxRange](#) to 720 the KNOB is able to rotate twice around its rotary axis. If [MinRange](#) and [MaxRange](#) are equal the KNOB will be able to rotate freely. Since 0 is the starting point, it is recommended to include 0 in the range.

### 6.2.34.1.6.16 KNOB\_SetRotateHQ()

### 6.2.34.1.6.17 KNOB\_SetRotateLQ()

#### Description

These functions are used to choose high and low quality rotating. The LQ variant has a better performance than HQ, but the HQ variant looks better.

#### Prototypes

```
void KNOB_SetRotateHQ(KNOB_Handle hObj);
```

```
void KNOB_SetRotateLQ(KNOB_Handle hObj);
```

#### Parameters

| Parameter            | Description            |
|----------------------|------------------------|
| <a href="#">hObj</a> | Handle of KNOB widget. |

### 6.2.34.1.6.18 KNOB\_SetSnap()

#### Description

Sets a range between snap positions where the KNOB automatically stops. After the KNOB starts rotating it calculates the closest snap position to its stopping point and stops at this snap position. If the KNOB is released between two snap positions it rotates to the closest.

#### Prototype

```
void KNOB_SetSnap(KNOB_Handle hObj,  
                 I32 Snap);
```

#### Parameters

| Parameter            | Description                                     |
|----------------------|---|
| <a href="#">hObj</a> | Handle of KNOB widget.                          |
| <a href="#">Snap</a> | Sets the range between snap positions in ticks. |

#### Additional information

If `TickSize` is set to 1 (default) and [Snap](#) is 300 every 30 degrees will be a snap position.

### 6.2.34.1.6.19 KNOB\_SetTickSize()

#### Description

Sets the tick size of the KNOB. The tick size defines the minimum movement of the knob in 1/10 of degrees.

#### Prototype

```
void KNOB_SetTickSize(KNOB_Handle hObj,  
                     I32          TickSize);
```

#### Parameters

| Parameter             | Description                           |
|-----------------------|---------------------------------------|
| <code>hObj</code>     | Handle of KNOB widget.                |
| <code>TickSize</code> | Sets the Ticksize of the KNOB widget. |

#### Additional information

The default `TickSize` is 1, it takes 3600 Ticks to fulfill one round. For example if `TickSize` is set to 10 the minimum movement is 1 degree and it takes 360 Ticks to fulfill one round. This function should be called before any other KNOB function.

### 6.2.34.1.6.20 KNOB\_SetUserData()

#### Description

Prototype explained at the beginning of the chapter as `<WIDGET>_SetUserData()` on page 995.

## 6.2.34.2 LISTWHEEL: Listwheel widget (obsolete)

### Note

The LISTWHEEL widget is obsolete and has been replaced with the WHEEL widget!

This widget is similar to the LISTBOX widget described earlier in this chapter. Whereas the data of a LISTBOX is selected by moving the cursor with the keyboard or by using a SCROLLBAR the LISTWHEEL works completely different: The whole data area can be moved via pointer input device (PID). Striking over the widget from top to bottom or vice versa moves the data up or downwards. When releasing the PID during the data area is moving it slows down its motion and stops by snapping in a new item at the snap position. Further the data is shown in a loop. After the last data item it continues with the first item like in a chain. So the data can be 'rotated' like a wheel:

| Description  | LISTWHEEL widget  |
|--|---|
| <p>Application example showing three wheels for selecting a date. The example uses the owner draw mechanism to overlay the widget with a customized alpha mask for the shading effect.</p> |  |

The table above shows a screenshot of the example `WIDGET_ListWheel.c` located in the example folder `Sample\Tutorial\` of the emWin package.

### Note

All LISTWHEEL-related routines are located in the file(s) `LISTWHEEL*.c`, `LISTWHEEL.h`. All identifiers are prefixed `LISTWHEEL`.

### 6.2.34.2.1 Configuration options

| Type | Macro                                       | Default                   | Description                        |
|------|---|---------------------------|------------------------------------|
| S    | <code>LISTWHEEL_FONT_DEFAULT</code>         | <code>GUI_Font13_1</code> | Font used.                         |
| N    | <code>LISTWHEEL_BKCOLOR0_DEFAULT</code>     | <code>GUI_WHITE</code>    | Background color of normal text.   |
| N    | <code>LISTWHEEL_BKCOLOR1_DEFAULT</code>     | <code>GUI_WHITE</code>    | Background color of selected text. |
| N    | <code>LISTWHEEL_TEXTCOLOR0_DEFAULT</code>   | <code>GUI_BLACK</code>    | Text color of normal text.         |
| N    | <code>LISTWHEEL_TEXTCOLOR1_DEFAULT</code>   | <code>GUI_BLUE</code>     | Text color of selected text.       |
| N    | <code>LISTWHEEL_TEXTALIGN_DEFAULT</code>    | <code>GUI_TA_LEFT</code>  | Text alignment.                    |
| N    | <code>LISTWHEEL_DECELERATION_DEFAULT</code> | 15                        | Deceleration value.                |
| N    | <code>LISTWHEEL_TIMER_PERIOD_DEFAULT</code> | 25                        | Timer period.                      |

### 6.2.34.2.2 Predefined IDs

The following symbols define IDs which may be used to make LISTWHEEL widgets distinguishable from creation.

```
#define GUI_ID_LISTVIEW0    0x200
#define GUI_ID_LISTVIEW1    0x201
#define GUI_ID_LISTVIEW2    0x202
#define GUI_ID_LISTVIEW3    0x203
#define GUI_ID_LISTVIEW4    0x204
#define GUI_ID_LISTVIEW5    0x205
#define GUI_ID_LISTVIEW6    0x206
#define GUI_ID_LISTVIEW7    0x207
#define GUI_ID_LISTVIEW8    0x208
#define GUI_ID_LISTVIEW9    0x209
```

### 6.2.34.2.3 Notification codes

The following events are sent from the widget to its parent window as part of a WM\_NOTIFY\_PARENT message:

| Message                     | Description   |
|-----------------------------|---|
| WM_NOTIFICATION_CLICKED     | Widget has been clicked.  |
| WM_NOTIFICATION_RELEASED    | Widget has been released.   |
| WM_NOTIFICATION_MOVED_OUT   | Widget has been clicked and pointer has been moved out of the widget without releasing. |
| WM_NOTIFICATION_SEL_CHANGED | An item has been snapped at the snap position.  |

### 6.2.34.2.4 Keyboard reaction

This widget currently does not react on keyboard input.



### 6.2.34.2.5 LISTWHEEL API

The table below lists the available emWin LISTWHEEL-related routines in alphabetical order. Detailed descriptions of the routines follow.

#### Functions

| Routine                                  | Description   |
|--|---|
| <code>LISTWHEEL_AddString()</code>       | Adds a new string.  |
| <code>LISTWHEEL_CreateEx()</code>        | Creates a LISTWHEEL widget.   |
| <code>LISTWHEEL_CreateIndirect()</code>  | Creates a LISTWHEEL widget from a resource table entry.   |
| <code>LISTWHEEL_CreateUser()</code>      | Creates a LISTWHEEL widget using extra bytes as user data.  |
| <code>LISTWHEEL_GetBkColor()</code>      | Returns the background color of the widget.   |
| <code>LISTWHEEL_GetFont()</code>         | Returns the font which is used to draw the data items of the given LISTWHEEL widget.                                |
| <code>LISTWHEEL_GetItemFromPos()</code>  | Returns the index of the item matching the given position.  |
| <code>LISTWHEEL_GetItemText()</code>     | Returns the text of the requested data item.  |
| <code>LISTWHEEL_GetLBorder()</code>      | Returns the size in pixels between the left border of the widget and the beginning of the text.                     |
| <code>LISTWHEEL_GetLineHeight()</code>   | Returns the height of one data item.  |
| <code>LISTWHEEL_GetNumItems()</code>     | Returns the number of data items of the given LISTWHEEL widget.   |
| <code>LISTWHEEL_GetPos()</code>          | Returns the zero-based index of the item which is currently snapped in.   |
| <code>LISTWHEEL_GetRBorder()</code>      | Returns the size in pixels between the right border of the widget and the end of the text.                          |
| <code>LISTWHEEL_GetSel()</code>          | Returns the zero-based index of the currently selected item.  |
| <code>LISTWHEEL_GetSnapPosition()</code> | Returns the position in pixels from the top of the LISTWHEEL widget at which the data items should be 'snapped in'. |
| <code>LISTWHEEL_GetTextAlign()</code>    | Returns the text alignment of the given LISTWHEEL widget.   |
| <code>LISTWHEEL_GetTextColor()</code>    | Returns the text color of the widget.   |
| <code>LISTWHEEL_GetUserData()</code>     | Retrieves the data set with <code>LISTWHEEL_SetUserData()</code> .  |
| <code>LISTWHEEL_IsMoving()</code>        | Returns the current state (moving or not moving) of the given LISTWHEEL widget.                                     |
| <code>LISTWHEEL_MoveToPos()</code>       | Moves the data area of the LISTWHEEL widget to the given position.  |
| <code>LISTWHEEL_OwnerDraw()</code>       | Default function for managing drawing operations of one data item.  |
| <code>LISTWHEEL_SetBkColor()</code>      | Sets the specified background color for selected and unselected items.  |
| <code>LISTWHEEL_SetDeceleration()</code> | Sets the deceleration behavior of the LISTWHEEL.  |
| <code>LISTWHEEL_SetFont()</code>         | Sets the font which should be used to draw the data items.  |
| <code>LISTWHEEL_SetLBorder()</code>      | Sets the size in pixels of the left border.   |

| Routine                                  | Description   |
|--|---|
| <code>LISTWHEEL_SetLineHeight()</code>   | Sets the line height used to draw a data item.  |
| <code>LISTWHEEL_SetOwnerDraw()</code>    | Sets an application defined owner draw function for the widget which is responsible for drawing the widget items. |
| <code>LISTWHEEL_SetPos()</code>          | Sets the data area of the LISTWHEEL widget to the given position.   |
| <code>LISTWHEEL_SetRBorder()</code>      | Sets the size in pixels of the right border.  |
| <code>LISTWHEEL_SetSel()</code>          | The function sets the selected item.  |
| <code>LISTWHEEL_SetSnapPosition()</code> | The function sets the relative position from the top of the widget at which the items should snap in.             |
| <code>LISTWHEEL_SetText()</code>         | It removes any existing item and adds the given items passed by the function.                                     |
| <code>LISTWHEEL_SetTextAlign()</code>    | Sets the text alignment used to draw the items of the LISTWHEEL widget.   |
| <code>LISTWHEEL_SetTextColor()</code>    | Sets the color to be used to draw the text.   |
| <code>LISTWHEEL_SetTimerPeriod()</code>  | Sets the time interval after which the LISTWHEEL will be updated in milliseconds.                                 |
| <code>LISTWHEEL_SetUserData()</code>     | Sets the extra data of a LISTWHEEL widget.  |
| <code>LISTWHEEL_SetVelocity()</code>     | Starts moving the LISTWHEEL widget using the given velocity.  |

## Defines

| Group of defines                     | Description                                 |
|--------------------------------------|---|
| <code>LISTWHEEL_color_indexes</code> | Color indexes used by the LISTWHEEL widget. |

### 6.2.34.2.5.1 LISTWHEEL\_AddString()

#### Description

Adds a new data item (typically a string) to the widget.

#### Prototype

```
void LISTWHEEL_AddString(      LISTWHEEL_Handle  hObj,  
                             const char        * pString);
```

#### Parameters

| Parameter            | Description                        |
|----------------------|------------------------------------|
| <code>hObj</code>    | Handle to a LISTVIEW widget        |
| <code>pString</code> | Pointer to the string to be added. |

#### Additional information

The width of the given text should fit into the horizontal widget area. Otherwise the text will be clipped during the drawing operation.

### 6.2.34.2.5.2 LISTWHEEL\_CreateEx()

#### Description

Creates a LISTWHEEL widget of a specified size at a specified location.

#### Prototype

```
LISTWHEEL_Handle LISTWHEEL_CreateEx(    int           x0,
                                        int           y0,
                                        int           xSize,
                                        int           ySize,
                                        WM_HWIN      hParent,
                                        int           WinFlags,
                                        int           ExFlags,
                                        int           Id,
                                        const GUI_ConstString * ppText);
```

#### Parameters

| Parameter             | Description  |
|-----------------------|--|
| <code>x0</code>       | Leftmost pixel of the widget (in parent coordinates).  |
| <code>y0</code>       | Topmost pixel of the widget (in parent coordinates).   |
| <code>xSize</code>    | Horizontal size of the widget (in pixels).   |
| <code>ySize</code>    | Vertical size of the widget (in pixels).   |
| <code>hParent</code>  | Handle of parent window. If 0, the new LISTVIEW widget will be a child of the desktop (top-level window).  |
| <code>WinFlags</code> | Window create flags. Typically <code>WM_CF_SHOW</code> in order to make the widget visible immediately (refer to <i>Window create flags</i> on page 977 for a list of available parameter values). |
| <code>ExFlags</code>  | Not used, reserved for future use.   |
| <code>Id</code>       | Window ID of the widget.   |
| <code>ppText</code>   | Pointer to an array of string pointers containing the elements to be displayed.  |

#### Return value

Handle of the created LISTWHEEL widget; 0 if the function fails.

#### Additional information

If the parameter `ppText` is used the last element of the array needs to be a `NULL` element.

#### Example

```
char * apText[] = {
    "Monday",
    "Tuesday",
    "Wednesday",
    "Thursday",
    "Friday",
    "Saturday",
    "Sunday",
    NULL
};
LISTWHEEL_CreateEx(10, 10, 100, 100, WM_HBKWIN, WM_CF_SHOW, 0, GUI_ID_LISTWHEEL0, apText);
```

### 6.2.34.2.5.3 LISTWHEEL\_CreateIndirect()

#### Description

The prototype of this function is explained at the beginning of this chapter. Details can be found in the description of the function `<WIDGET>_CreateIndirect()` on page 992. The element `Para` of the according `GUI_WIDGET_CREATE_INFO` structure is not used. The element `Flags` is used according to the parameter `WinFlags` of the function `LISTWHEEL_CreateEx()`.

#### 6.2.34.2.5.4 LISTWHEEL\_CreateUser()

##### Description

Prototype explained at the beginning of the chapter as `<WIDGET>_CreateUser()` on page 993. For a detailed description of the parameters the function `LISTWHEEL_CreateEx()` can be referred to.

### 6.2.34.2.5.5 LISTWHEEL\_GetBkColor()

#### Description

Returns the background color of the widget.

#### Prototype

```
GUI_COLOR LISTWHEEL_GetBkColor(LISTWHEEL_Handle hObj,  
                               unsigned int      Index);
```

#### Parameters

| Parameter             | Description  |
|-----------------------|--|
| <a href="#">hObj</a>  | Handle of LISTWHEEL widget.  |
| <a href="#">Index</a> | See <i>LISTWHEEL color indexes</i> on page 2420 for a full list of permitted values. |

#### Return value

The background color of the given widget.

### 6.2.34.2.5.6 LISTWHEEL\_GetFont()

#### Description

Returns the font which is used to draw the data items of the given LISTWHEEL widget.

#### Prototype

```
GUI_FONT *LISTWHEEL_GetFont(LISTWHEEL_Handle hObj);
```

#### Parameters

| Parameter            | Description                 |
|----------------------|-----------------------------|
| <a href="#">hObj</a> | Handle of LISTWHEEL widget. |

#### Return value

Pointer to a GUI\_FONT structure which is used to draw the data items.



### 6.2.34.2.5.7 LISTWHEEL\_GetItemFromPos()

#### Description

Returns the index of the item matching the given position.

#### Prototype

```
int LISTWHEEL_GetItemFromPos(LISTWHEEL_Handle hObj,  
                             int yPos);
```

#### Parameters

| Parameter         | Description                         |
|-------------------|-------------------------------------|
| <code>hObj</code> | Handle of LISTWHEEL widget.         |
| <code>yPos</code> | Y-position of the LISTWHEEL widget. |

#### Return value

Index of the item matching the given position. -1, if an item index could not be determined.

### 6.2.34.2.5.8 LISTWHEEL\_GetItemText()

#### Description

Returns the text of the requested data item.

#### Prototype

```
void LISTWHEEL_GetItemText(LISTWHEEL_Handle hObj,  
                           unsigned Index,  
                           char * pBuffer,  
                           int MaxSize);
```

#### Parameters

| Parameter               | Description                                  |
|-------------------------|--|
| <a href="#">hObj</a>    | Handle of LISTWHEEL widget.                  |
| <a href="#">Index</a>   | <a href="#">Index</a> of the requested item. |
| <a href="#">pBuffer</a> | Buffer for storing the text.                 |
| <a href="#">MaxSize</a> | Size in bytes of the buffer.                 |

#### Return value

The function copies the text of the given item into the given buffer. If the size of the buffer is too small the text will be clipped.

### 6.2.34.2.5.9 LISTWHEEL\_GetLBorder()

#### Description

Returns the size in pixels between the left border of the widget and the beginning of the text.

#### Prototype

```
int LISTWHEEL_GetLBorder(LISTWHEEL_Handle hObj);
```

#### Parameters

| Parameter            | Description                 |
|----------------------|-----------------------------|
| <a href="#">hObj</a> | Handle of LISTWHEEL widget. |

#### Return value

Number of pixels between left border and text.

### 6.2.34.2.5.10 LISTWHEEL\_GetLineHeight()

#### Description

Returns the height of one data item.

#### Prototype

```
unsigned LISTWHEEL_GetLineHeight(LISTWHEEL_Handle hObj);
```

#### Parameters

| Parameter            | Description                 |
|----------------------|-----------------------------|
| <a href="#">hObj</a> | Handle of LISTWHEEL widget. |

#### Return value

Height of one data item.

#### Additional information

This function returns the value set by the function `LISTWHEEL_SetLineHeight()`. A return value of zero means the height of one item depends on the size of the current font. For more details, refer to `LISTWHEEL_SetLineHeight()`, `LISTWHEEL_GetFont()` and `GUI_GetYSize-OfFont()`.

### 6.2.34.2.5.11 LISTWHEEL\_GetNumItems()

#### Description

Returns the number of data items of the given LISTWHEEL widget.

#### Prototype

```
int LISTWHEEL_GetNumItems(LISTWHEEL_Handle hObj);
```

#### Parameters

| Parameter            | Description                 |
|----------------------|-----------------------------|
| <a href="#">hObj</a> | Handle of LISTWHEEL widget. |

#### Return value

Number of data items of the given LISTWHEEL widget.

### 6.2.34.2.5.12 LISTWHEEL\_GetPos()

#### Description

Returns the zero-based index of the item which is currently snapped in.

#### Prototype

```
int LISTWHEEL_GetPos(LISTWHEEL_Handle hObj);
```

#### Parameters

| Parameter            | Description                 |
|----------------------|-----------------------------|
| <a href="#">hObj</a> | Handle of LISTWHEEL widget. |

#### Return value

Index of the item which is currently snapped in.

#### Additional information

The position at which the items being snapped can be set with the function `LISTWHEEL_SetSnapPosition()`. For more details, refer to `LISTWHEEL_SetSnapPosition()`.

### 6.2.34.2.5.13 LISTWHEEL\_GetRBorder()

#### Description

Returns the size in pixels between the right border of the widget and the end of the text.

#### Prototype

```
int LISTWHEEL_GetRBorder(LISTWHEEL_Handle hObj);
```

#### Parameters

| Parameter            | Description                 |
|----------------------|-----------------------------|
| <a href="#">hObj</a> | Handle of LISTWHEEL widget. |

#### Return value

Number of pixels between right border and text.

#### 6.2.34.2.5.14 LISTWHEEL\_GetSel()

##### Description

Returns the zero-based index of the currently selected item.

##### Prototype

```
int LISTWHEEL_GetSel(LISTWHEEL_Handle hObj);
```

##### Parameters

| Parameter            | Description                 |
|----------------------|-----------------------------|
| <a href="#">hObj</a> | Handle of LISTWHEEL widget. |

##### Return value

Index of the currently selected item.

##### Additional information

For more information, refer to `LISTWHEEL_SetSel()`.



### 6.2.34.2.5.15 LISTWHEEL\_GetSnapPosition()

#### Description

Returns the position in pixels from the top of the LISTWHEEL widget at which the data items should be 'snapped in'.

#### Prototype

```
int LISTWHEEL_GetSnapPosition(LISTWHEEL_Handle hObj);
```

#### Parameters

| Parameter            | Description                 |
|----------------------|-----------------------------|
| <a href="#">hObj</a> | Handle of LISTWHEEL widget. |

#### Return value

Snap position in pixels from the top edge of the LISTWHEEL widget.

#### Additional information

The default value is 0.

### 6.2.34.2.5.16 LISTWHEEL\_GetTextAlign()

#### Description

Returns the text alignment of the given LISTWHEEL widget.

#### Prototype

```
int LISTWHEEL_GetTextAlign(LISTWHEEL_Handle hObj);
```

#### Parameters

| Parameter            | Description                 |
|----------------------|-----------------------------|
| <a href="#">hObj</a> | Handle of LISTWHEEL widget. |

#### Return value

Text alignment of the given LISTWHEEL widget.

#### Additional information

For more information, refer to [LISTWHEEL\\_SetTextAlign\(\)](#).

### 6.2.34.2.5.17 LISTWHEEL\_GetTextColor()

#### Description

Returns the text color of the widget.

#### Prototype

```
GUI_COLOR LISTWHEEL_GetTextColor(LISTWHEEL_Handle hObj,  
                                unsigned int      Index);
```

#### Parameters

| Parameter             | Description  |
|-----------------------|--|
| <a href="#">hObj</a>  | Handle of LISTWHEEL widget.  |
| <a href="#">Index</a> | See <i>LISTWHEEL color indexes</i> on page 2420 for a full list of permitted values. |

#### Return value

The text color of the given widget.

### 6.2.34.2.5.18 LISTWHEEL\_GetUserData()

#### Description

Prototype explained at the beginning of the chapter as `<WIDGET>_GetUserData()` on page 994.

### 6.2.34.2.5.19 LISTWHEEL\_IsMoving()

#### Description

Returns the current state (moving or not moving) of the given LISTWHEEL widget.

#### Prototype

```
int LISTWHEEL_IsMoving(LISTWHEEL_Handle hObj);
```

#### Parameters

| Parameter             | Description                 |
|-----------------------|-----------------------------|
| <a href="#">hObj</a>  | Handle of LISTWHEEL widget. |
| <a href="#">Index</a> | See table below.            |

#### Return value

|   |            |
|---|------------|
| 0 | not moving |
| 1 | moving     |

### 6.2.34.2.5.20 LISTWHEEL\_MoveToPos()

#### Description

Moves the data area of the LISTWHEEL widget to the given position.

#### Prototype

```
void LISTWHEEL_MoveToPos(LISTWHEEL_Handle hObj,  
                        unsigned int      Index);
```

#### Parameters

| Parameter          | Description  |
|--------------------|--|
| <code>hObj</code>  | Handle of LISTWHEEL widget.                                    |
| <code>Index</code> | Zero-based index of the item to which the 'wheel' should move. |

#### Additional information

The widget starts moving by choosing the shortest way. If for example 7 items are available and item 2 is currently snapped and the widget should move to the last item it begins moving backwards until the seventh item has been reached. Detailed information on how to set a position can be found in the description of `LISTWHEEL_SetPos()`.

### 6.2.34.2.5.21 LISTWHEEL\_OwnerDraw()

#### Description

Default function for managing drawing operations of one data item.

#### Prototype

```
int LISTWHEEL_OwnerDraw(const WIDGET_ITEM_DRAW_INFO * pDrawItemInfo);
```

#### Parameters

| Parameter          | Description  |
|--------------------|--|
| <code>hObj</code>  | Handle of LISTWHEEL widget.                                    |
| <code>Index</code> | Zero-based index of the item to which the 'wheel' should move. |

#### Return value

Depends on the command in the `Cmd` element of the `WIDGET_ITEM_DRAW_INFO` structure pointed by `pDrawItemInfo`.

#### Additional information

This function is useful if `LISTWHEEL_SetOwnerDraw()` is used. It can be used to retrieve the original size of a data item and/or to draw the text of a data item and should be called for all commands which are not managed by the application defined owner draw function. For more information, refer to *User drawn widgets* on page 1001, `LISTWHEEL_SetOwnerDraw()` and to the provided example.

### 6.2.34.2.5.22 LISTWHEEL\_SetBkColor()

| Before   | After  |
|--|--|
| <div style="border: 1px solid black; padding: 5px;"> <p style="text-align: center;">Saturday</p> <p style="text-align: center;">Sunday</p> <hr style="border: 1px solid red;"/> <p style="text-align: center; color: blue;">Monday</p> <hr style="border: 1px solid red;"/> <p style="text-align: center;">Tuesday</p> <p style="text-align: center;">Wednesday</p> </div> | <div style="border: 1px solid black; padding: 5px;"> <p style="text-align: center; background-color: blue;">Saturday</p> <p style="text-align: center; background-color: blue;">Sunday</p> <hr style="border: 1px solid red;"/> <p style="text-align: center; background-color: gray; color: blue;">Monday</p> <hr style="border: 1px solid red;"/> <p style="text-align: center; background-color: blue;">Tuesday</p> <p style="text-align: center; background-color: blue;">Wednesday</p> </div> |

#### Description

Sets the specified background color for selected and unselected items.

#### Prototype

```
void LISTWHEEL_SetBkColor(LISTWHEEL_Handle hObj,
                          unsigned int     Index,
                          GUI_COLOR       Color);
```

#### Parameters

| Parameter          | Description  |
|--------------------|--|
| <code>hObj</code>  | Handle of LISTWHEEL widget.  |
| <code>Index</code> | See <i>LISTWHEEL color indexes</i> on page 2420 for a full list of permitted values. |
| <code>Color</code> | New background color.  |



### 6.2.34.2.5.23 LISTWHEEL\_SetDeceleration()

#### Description

Sets the deceleration behavior of the LISTWHEEL. The higher the deceleration value, the less time it takes for the LISTWHEEL to stop moving.

#### Prototype

```
void LISTWHEEL_SetDeceleration(LISTWHEEL_Handle hObj,  
                               unsigned          Deceleration);
```

#### Parameters

| Parameter                 | Description                      |
|---------------------------|----------------------------------|
| <code>hObj</code>         | Handle of LISTWHEEL widget.      |
| <code>Deceleration</code> | <code>Deceleration</code> value. |

#### Additional information

The default value of the deceleration is 15. This can be change with the configuration option LISTWHEEL\_DECELERATION\_DEFAULT.

### 6.2.34.2.5.24 LISTWHEEL\_SetFont()

| Before  | After  |
|---|--|
| <div style="border: 1px solid black; padding: 5px;">           Friday<br/>           Saturday<br/> <hr style="border: 1px solid red;"/>           Sunday<br/> <hr style="border: 1px solid red;"/>           Monday<br/>           Tuesday         </div> | <div style="border: 1px solid black; padding: 5px;"> <b>Friday</b><br/> <b>Saturday</b><br/> <hr style="border: 1px solid red;"/> <b>Sunday</b><br/> <hr style="border: 1px solid red;"/> <b>Monday</b><br/> <b>Tuesday</b> </div> |

#### Description

Sets the font which should be used to draw the data items.

#### Prototype

```
void LISTWHEEL_SetFont(      LISTWHEEL_Handle  hObj,
                           const GUI_FONT      * pFont);
```

#### Parameters

| Parameter          | Description                      |
|--------------------|----------------------------------|
| <code>hObj</code>  | Handle of LISTWHEEL widget.      |
| <code>pFont</code> | Pointer to a GUI_FONT structure. |

### 6.2.34.2.5.25 LISTWHEEL\_SetLBorder()

| Before   | After  |
|--|--|
| <div style="border: 1px solid black; padding: 5px;"> <p>Friday</p> <p>Saturday</p> <hr style="border: 1px solid red;"/> <p>Sunday</p> <hr style="border: 1px solid red;"/> <p>Monday</p> <p>Tuesday</p> </div> | <div style="border: 1px solid black; padding: 5px;"> <p>Friday</p> <p>Saturday</p> <hr style="border: 1px solid red;"/> <p>Sunday</p> <hr style="border: 1px solid red;"/> <p>Monday</p> <p>Tuesday</p> </div> |

#### Description

Sets the border size between the left edge of the widget and the beginning of the text.

#### Prototype

```
void LISTWHEEL_SetLBorder(LISTWHEEL_Handle hObj,
                          unsigned        BorderSize);
```



#### Parameters

| Parameter               | Description                 |
|-------------------------|-----------------------------|
| <code>hObj</code>       | Handle of LISTWHEEL widget. |
| <code>BorderSize</code> | Desired border size.        |

#### Additional information

The default value of the border size is 0.

### 6.2.34.2.5.26 LISTWHEEL\_SetLineHeight()

| Before  | After  |
|---|--|
|  |  |

#### Description

Sets the line height used to draw a data item.

#### Prototype

```
void LISTWHEEL_SetLineHeight(LISTWHEEL_Handle hObj,
                             unsigned LineHeight);
```

#### Parameters

| Parameter               | Description   |
|-------------------------|---|
| <code>hObj</code>       | Handle of LISTWHEEL widget.   |
| <code>LineHeight</code> | Desired height. Default is 0 which means the font size determines the height of a line. |

#### Additional information

Per default the height of a line depends on the used font. The value set by this function 'overwrites' this default behavior.

### 6.2.34.2.5.27 LISTWHEEL\_SetOwnerDraw()

| Before   | After  |
|--|--|
| <div style="border: 1px solid black; padding: 5px; width: fit-content; margin: auto;">                     Friday<br/>                     Saturday<br/>                     Sunday<br/> <b>Monday</b><br/>                     Tuesday                 </div> | <div style="border: 1px solid black; padding: 5px; width: fit-content; margin: auto;">                     Friday<br/>                     Saturday<br/> <hr style="border: 1px solid red;"/>                     Sunday<br/> <hr style="border: 1px solid red;"/> <b>Monday</b><br/>                     Tuesday                 </div> |

#### Description

Sets an application defined owner draw function for the widget which is responsible for drawing the widget items.

#### Prototype

```
void LISTWHEEL_SetOwnerDraw(LISTWHEEL_Handle hObj,
                            WIDGET_DRAW_ITEM_FUNC * pfOwnerDraw);
```

#### Parameters

| Parameter                | Description                     |
|--------------------------|---------------------------------|
| <code>hObj</code>        | Handle of LISTWHEEL widget.     |
| <code>pfOwnerDraw</code> | Pointer to owner draw function. |

#### Supported commands

- WIDGET\_ITEM\_GET\_XSIZE
- WIDGET\_ITEM\_GET\_YSIZE
- WIDGET\_ITEM\_DRAW
- WIDGET\_ITEM\_DRAW\_BACKGROUND
- WIDGET\_ITEM\_DRAW\_OVERLAY

#### Additional information

This function sets a pointer to an application defined function which will be called by the widget when a data item has to be drawn or when the x or y size of a item is needed. It gives you the possibility to draw anything as data item, not just plain text. `pfDrawItem` is a pointer to an application-defined function of type `WIDGET_DRAW_ITEM_FUNC` which is explained at the beginning of the chapter.

The following commands are supported: `WIDGET_ITEM_GET_YSIZE`, `WIDGET_ITEM_DRAW`, `WIDGET_DRAW_BACKGROUND` and `WIDGET_DRAW_OVERLAY`.

#### Example

The following example routine draws 2 red indicator lines over the widget:

```
static int _OwnerDraw(const WIDGET_DRAW_ITEM_FUNC * pDrawItemInfo) {
    switch (pDrawItemInfo->Cmd) {
        case WIDGET_DRAW_OVERLAY:
            GUI_SetColor(GUI_RED);
            GUI_DrawHLine(40, 0, 99);
            GUI_DrawHLine(59, 0, 99);
            break;
        default:
            return LISTWHEEL_OwnerDraw(pDrawItemInfo);
    }
    return 0;
}
```

### 6.2.34.2.5.28 LISTWHEEL\_SetPos()

#### Description

Sets the data area of the LISTWHEEL widget to the given position.

#### Prototype

```
void LISTWHEEL_SetPos(LISTWHEEL_Handle hObj,  
                      unsigned Index);
```

#### Parameters

| Parameter             | Description  |
|-----------------------|--|
| <a href="#">hObj</a>  | Handle of LISTWHEEL widget.                                      |
| <a href="#">Index</a> | Zero-based index of the item to which the 'wheel' should be set. |

#### Additional information

Detailed information on how to move the LISTWHEEL to a position can be found in the description of `LISTWHEEL_MoveToPos()`.

### 6.2.34.2.5.29 LISTWHEEL\_SetRBorder()

| Before   | After  |
|--|--|
| <div style="border: 1px solid black; padding: 5px;"> <p>Friday</p> <p>Saturday</p> <hr style="border: 1px solid red;"/> <p>Sunday</p> <hr style="border: 1px solid red;"/> <p>Monday</p> <p>Tuesday</p> </div> | <div style="border: 1px solid black; padding: 5px;"> <p>Friday</p> <p>Saturday</p> <hr style="border: 1px solid red;"/> <p>Sunday</p> <hr style="border: 1px solid red;"/> <p>Monday</p> <p>Tuesday</p> </div> |

#### Description

Sets the border size between the left edge of the widget and the beginning of the text.

#### Prototype

```
void LISTWHEEL_SetRBorder(LISTWHEEL_Handle hObj,
                          unsigned        BorderSize);
```

#### Parameters

| Parameter               | Description                 |
|-------------------------|-----------------------------|
| <code>hObj</code>       | Handle of LISTWHEEL widget. |
| <code>BorderSize</code> | Desired border size.        |

#### Additional information

The default value of the border size is 0.

### 6.2.34.2.5.30 LISTWHEEL\_SetSel()

| Before  | After   |
|---|---|
| <div style="border: 1px solid black; padding: 5px; text-align: center;">           Friday<br/>           Saturday<br/> <hr style="border: 1px solid red;"/>           Sunday<br/> <hr style="border: 1px solid red;"/> <b style="color: blue;">Monday</b><br/>           Tuesday         </div> | <div style="border: 1px solid black; padding: 5px; text-align: center;">           Friday<br/>           Saturday<br/> <hr style="border: 1px solid red;"/> <b style="color: blue;">Sunday</b><br/> <hr style="border: 1px solid red;"/>           Monday<br/> <b style="color: blue;">Tuesday</b> </div> |

#### Description

The function sets the selected item.

#### Prototype

```
void LISTWHEEL_SetSel(LISTWHEEL_Handle hObj,
                     int Sel);
```

#### Parameters

| Parameter         | Description                              |
|-------------------|--|
| <code>hObj</code> | Handle of LISTWHEEL widget.              |
| <code>Sel</code>  | Zero-based index of item to be selected. |

#### Additional information

Only one item can be selected. Per default the item with index 0 is selected.



### 6.2.34.2.5.31 LISTWHEEL\_SetSnapPosition()

| Before   | After  |
|--|--|
| <div style="border: 1px solid black; padding: 5px;"> <p><b>Monday</b></p> <p>Tuesday</p> <p>Wednesday</p> <p>Thursday</p> <p>Friday</p> </div> | <div style="border: 1px solid black; padding: 5px;"> <p>Saturday</p> <p>Sunday</p> <p><b>Monday</b></p> <p>Tuesday</p> <p>Wednesday</p> </div> |

#### Description

The function sets the relative position from the top of the widget at which the items should snap in.

#### Prototype

```
void LISTWHEEL_SetSnapPosition(LISTWHEEL_Handle hObj,
                               int SnapPosition);
```

#### Parameters

| Parameter                 | Description   |
|---------------------------|---|
| <code>hObj</code>         | Handle of LISTWHEEL widget.   |
| <code>SnapPosition</code> | Relative position in pixels from the top of the widget at which the items should be snapped in. |

#### Additional information

Per default the snap position is 0 which means the items are snapped in at the top of the widget. The function `LISTWHEEL_GetPos()` can be used to get the zero based index of the current item which has been snapped in.

### 6.2.34.2.5.32 LISTWHEEL\_SetText()

| Before  | After  |
|---|--|
| <div style="border: 1px solid black; padding: 5px; text-align: center;">           Friday<br/>           Saturday<br/> <hr style="border: 1px solid red;"/>           Sunday<br/> <hr style="border: 1px solid red;"/>           Monday<br/>           Tuesday         </div> | <div style="border: 1px solid black; padding: 5px; text-align: center;">           November<br/>           December<br/> <hr style="border: 1px solid red;"/>           January<br/> <hr style="border: 1px solid red;"/>           February<br/>           March         </div> |

#### Description

It removes any existing item and adds the given items passed by the function.

#### Prototype

```
void LISTWHEEL_SetText(      LISTWHEEL_Handle  hObj,
                          const GUI_ConstString * ppText);
```

#### Parameters

| Parameter           | Description   |
|---------------------|---|
| <code>hObj</code>   | Handle of LISTWHEEL widget.   |
| <code>ppText</code> | Pointer to an array of strings. The last item needs to be a NULL pointer. |

#### Additional information

Note that the last element pointed to by `ppText` needs to be a NULL pointer.

#### Example

The following example should demonstrate how the function should be used:

```
static char * _apText[] = {
    "Monday",
    "Tuesday",
    "Wednesday",
    "Thursday",
    "Friday",
    "Saturday",
    "Sunday",
    NULL
};
static void _SetContent(void) {
    LISTWHEEL_SetText(hWin, _apText);
}
```

### 6.2.34.2.5.33 LISTWHEEL\_SetTextAlign()

| Before  | After  |
|---|--|
| <div style="border: 1px solid black; padding: 5px;">           Friday<br/>           Saturday<br/> <hr style="border: 1px solid red;"/>           Sunday<br/> <hr style="border: 1px solid red;"/>           Monday<br/>           Tuesday         </div> | <div style="border: 1px solid black; padding: 5px;">           Saturday<br/>           Sunday<br/> <hr style="border: 1px solid red;"/>           Monday<br/> <hr style="border: 1px solid red;"/>           Tuesday<br/>           Wednesday         </div> |

#### Description

Sets the text alignment used to draw the items of the LISTWHEEL widget.

#### Prototype

```
void LISTWHEEL_SetTextAlign(LISTWHEEL_Handle hObj,
                           int Align);
```

#### Parameters

| Parameter          | Description   |
|--------------------|---|
| <code>hObj</code>  | Handle of LISTWHEEL widget.                           |
| <code>Align</code> | Alignment to be used to draw the items of the widget. |

#### Additional information

For details about text alignment, refer to `GUI_SetTextAlign()`.

### 6.2.34.2.5.34 LISTWHEEL\_SetTextColor()

| Before  | After  |
|---|--|
| <div style="border: 1px solid black; padding: 5px;">           Friday<br/>           Saturday<br/> <hr style="border: 1px solid red;"/>           Sunday<br/> <hr style="border: 1px solid red;"/>           Monday<br/>           Tuesday         </div> | <div style="border: 1px solid black; padding: 5px;">           Saturday<br/>           Sunday<br/> <hr style="border: 1px solid red;"/>           Monday<br/> <hr style="border: 1px solid red;"/>           Tuesday<br/>           Wednesday         </div> |

#### Description

Sets the color to be used to draw the text.

#### Prototype

```
void LISTWHEEL_SetTextColor(LISTWHEEL_Handle hObj,
                           unsigned int      Index,
                           GUI_COLOR        Color);
```

#### Parameters

| Parameter          | Description   |
|--------------------|---|
| <code>hObj</code>  | Handle of LISTWHEEL widget.   |
| <code>Index</code> | See table below. See <i>LISTWHEEL color indexes</i> on page 2420 for a full list of permitted values. |
| <code>Color</code> | <code>Color</code> to be used.  |

### 6.2.34.2.5.35 LISTWHEEL\_SetTimerPeriod()

#### Description

Sets the time interval after which the LISTWHEEL will be updated in milliseconds. By default this will be every 25ms.

#### Prototype

```
void LISTWHEEL_SetTimerPeriod(LISTWHEEL_Handle hObj,  
                             GUI_TIMER_TIME   TimerPeriod);
```

#### Parameters

| Parameter                | Description                                   |
|--------------------------|---|
| <code>hObj</code>        | Handle of LISTWHEEL widget.                   |
| <code>TimerPeriod</code> | Timer period used for updating the LISTWHEEL. |

#### Additional information

The default value of 25 can be set with the configuration option `LISTWHEEL_TIMER_PERIOD`.

### 6.2.34.2.5.36 LISTWHEEL\_SetUserData()

#### Description

Prototype explained at the beginning of the chapter as `<WIDGET>_SetUserData()` on page 995.

### 6.2.34.2.5.37 LISTWHEEL\_SetVelocity()

#### Description

Starts moving the LISTWHEEL widget using the given velocity.

#### Prototype

```
void LISTWHEEL_SetVelocity(LISTWHEEL_Handle hObj,  
                           int Velocity);
```

#### Parameters

| Parameter             | Description                 |
|-----------------------|-----------------------------|
| <code>hObj</code>     | Handle of LISTWHEEL widget. |
| <code>Velocity</code> | Starting speed.             |

#### Additional information

The velocity decreases automatically. The higher the given velocity the longer it takes for the movement to stop.

#### Example

This function is used in the sample applications `MEMDEV_ListWheelEffects.c` and `WIDGET_ListWheel.c`.

### 6.2.34.2.5.38 LISTWHEEL color indexes

#### Description

Color indexes to be used by the LISTWHEEL widget.

#### Definition

```
#define LISTWHEEL_CI_UNSEL 0
#define LISTWHEEL_CI_SEL 1
```

#### Symbols

| Definition                         | Description                  |
|------------------------------------|------------------------------|
| <a href="#">LISTWHEEL_CI_UNSEL</a> | Color of unselected element. |
| <a href="#">LISTWHEEL_CI_SEL</a>   | Color of selected element.   |



### 6.2.34.3 SCROLLBAR: Scroll bar widget (obsolete)

#### Note

The SCROLLBAR widget is obsolete, the SCROLLER widget should be used instead!

Scroll bars are used for scrolling through list boxes or any other type of window. They may be created horizontally, as shown below, or vertically.



A scroll bar is typically attached to an existing window, for example the list box shown below:



#### Note

All SCROLLBAR-related routines are located in the file(s) `SCROLLBAR*.c`, `SCROLLBAR.h`. All identifiers are prefixed `SCROLLBAR`.

#### Skining...



...is available for this widget. The screenshot above shows the widget using the default skin. Details can be found in the chapter *Skining* on page 2509.

#### 6.2.34.3.1 Configuration options

| Type | Macro                            | Default   | Description              |
|------|----------------------------------|-----------|--------------------------|
| N    | SCROLLBAR_COLOR_SHAFT_DEFAULT    | 0x808080  | Color of the shaft.      |
| N    | SCROLLBAR_COLOR_ARROW_DEFAULT    | GUI_BLACK | Color of the arrows.     |
| N    | SCROLLBAR_COLOR_THUMB_DEFAULT    | 0xc0c0c0  | Color of the thumb area. |
| N    | SCROLLBAR_THUMB_SIZE_MIN_DEFAULT | 4         | Minimum thumb size.      |

#### 6.2.34.3.2 Predefined IDs

The following symbols define IDs which may be used to make SCROLLBAR widgets distinguishable from creation.

```
#define GUI_ID_SCROLLBAR0    0x140
#define GUI_ID_SCROLLBAR1    0x141
#define GUI_ID_SCROLLBAR2    0x142
#define GUI_ID_SCROLLBAR3    0x143
#define GUI_ID_SCROLLBAR4    0x144
#define GUI_ID_SCROLLBAR5    0x145
#define GUI_ID_SCROLLBAR5    0x146
#define GUI_ID_SCROLLBAR7    0x147
#define GUI_ID_SCROLLBAR8    0x148
#define GUI_ID_SCROLLBAR9    0x149
```

### 6.2.34.3.3 Notification codes

The following events are sent from a scroll bar widget to its parent window as part of a WM\_NOTIFY\_PARENT message:

| Message                         | Description   |
|---------------------------------|---|
| WM_NOTIFICATION_CLICKED         | SCROLLBAR has been clicked.   |
| WM_NOTIFICATION_RELEASED        | SCROLLBAR has been released.  |
| WM_NOTIFICATION_SCROLLBAR_ADDED | SCROLLBAR has just been added (attached) to an existing window. The window needs to be informed so that it can initialize the scroll bar. |
| WM_NOTIFICATION_VALUE_CHANGED   | Value of SCROLLBAR has changed, either by moving the thumb or by pressing the arrow buttons.  |

### 6.2.34.3.4 Keyboard reaction

The widget reacts to the following keys if it has the input focus:

| Message        | Description  |
|----------------|--|
| GUI_KEY_RIGHT  | Increments the current value of the SCROLLBAR widget by 1.                               |
| GUI_KEY_DOWN   | Increments the current value of the SCROLLBAR widget by 1.                               |
| GUI_KEY_PGDOWN | Increments the current value of the SCROLLBAR widget by a value which represents 1 page. |
| GUI_KEY_LEFT   | Decrements the current value of the SCROLLBAR widget by 1.                               |
| GUI_KEY_UP     | Decrements the current value of the SCROLLBAR widget by 1.                               |
| GUI_KEY_PGUP   | Decrements the current value of the SCROLLBAR widget by a value which represents 1 page. |

### 6.2.34.3.5 SCROLLBAR API

The table below lists the available emWin SCROLLBAR-related routines in alphabetical order. Detailed descriptions of the routines follow.

#### Functions

| Routine                                  | Description  |
|--|--|
| <code>SCROLLBAR_AddValue()</code>        | Increments or decrements the value of the SCROLLBAR widget by a specified value. |
| <code>SCROLLBAR_Create()</code>          | Creates a SCROLLBAR widget. (Obsolete)   |
| <code>SCROLLBAR_CreateAttached()</code>  | Creates a SCROLLBAR widget attached to a window.                                 |
| <code>SCROLLBAR_CreateEx()</code>        | Creates a SCROLLBAR widget.  |
| <code>SCROLLBAR_CreateIndirect()</code>  | Creates a SCROLLBAR widget from resource table entry.                            |
| <code>SCROLLBAR_CreateUser()</code>      | Creates a SCROLLBAR widget using extra bytes as user data.                       |
| <code>SCROLLBAR_Dec()</code>             | Decrements the current value of the given SCROLLBAR widget by a value of 1.      |
| <code>SCROLLBAR_GetColor()</code>        | Returns the color attributes of the SCROLLBAR.                                   |
| <code>SCROLLBAR_GetDefaultWidth()</code> | Returns the default width of a SCROLLBAR widget.                                 |
| <code>SCROLLBAR_GetNumItems()</code>     | Returns the number of SCROLLBAR items.   |
| <code>SCROLLBAR_GetPageSize()</code>     | Returns the page size.   |
| <code>SCROLLBAR_GetThumbSizeMin()</code> | Returns the minimum thumb size in pixels.  |
| <code>SCROLLBAR_GetUserData()</code>     | Retrieves the data set with <code>SCROLLBAR_SetUserData()</code> .               |
| <code>SCROLLBAR_GetValue()</code>        | Returns the value of the current item.   |
| <code>SCROLLBAR_Inc()</code>             | Increments the current value of the given SCROLLBAR widget by a value of 1.      |
| <code>SCROLLBAR_SetColor()</code>        | Sets the color of a SCROLLBAR widget.  |
| <code>SCROLLBAR_SetDefaultColor()</code> | Sets the default colors for new SCROLLBAR widgets.                               |
| <code>SCROLLBAR_SetDefaultWidth()</code> | Sets the default width of SCROLLBAR widgets.                                     |
| <code>SCROLLBAR_SetNumItems()</code>     | Sets the number of items for scrolling.  |
| <code>SCROLLBAR_SetPageSize()</code>     | Sets the page size.  |
| <code>SCROLLBAR_SetState()</code>        | Sets the state of a SCROLLBAR widget.  |
| <code>SCROLLBAR_SetThumbSizeMin()</code> | Sets the minimum thumb size in pixels.   |
| <code>SCROLLBAR_SetUserData()</code>     | Sets the extra data of a SCROLLBAR widget.                                       |
| <code>SCROLLBAR_SetValue()</code>        | Sets the value of the given SCROLLBAR widget.                                    |
| <code>SCROLLBAR_SetWidth()</code>        | Sets the width of the given SCROLLBAR widget.                                    |

#### Defines

| Group of defines                     | Description   |
|--------------------------------------|---|
| <code>SCROLLBAR_color_indexes</code> | Color indexes for SCROLLBAR widget.                     |
| <code>SCROLLBAR_create_flags</code>  | Create flags to be used for creating SCROLLBAR widgets. |

### 6.2.34.3.5.1 SCROLLBAR\_AddValue()

#### Description

Increments or decrements the value of the SCROLLBAR widget by a specified value.

#### Prototype

```
void SCROLLBAR_AddValue(SCROLLBAR_Handle hObj,  
                        int Add);
```

#### Parameters

| Parameter            | Description  |
|----------------------|--|
| <a href="#">hObj</a> | Handle of SCROLLBAR.                                   |
| <a href="#">Add</a>  | Number of items to increment or decrement at one time. |

#### Additional information

The SCROLLBAR widget cannot exceed the value set in `SCROLLBAR_SetNumItems()`. For example, if a window contains 200 items and the scroll bar is currently at value 195, incrementing the bar by 3 items will move it to value 198. However, incrementing by 10 items will only move the bar as far as value 200, which is the maximum value for this particular window.

### 6.2.34.3.5.2 SCROLLBAR\_Create()

#### Note

This function is **deprecated**, `SCROLLBAR_CreateEx()` should be used instead.

#### Description

Creates a SCROLLBAR widget of a specified size at a specified location.

#### Prototype

```
SCROLLBAR_Handle SCROLLBAR_Create(int    x0,
                                   int    y0,
                                   int    xSize,
                                   int    ySize,
                                   WM_HWIN hParent,
                                   int    Id,
                                   int    WinFlags,
                                   int    SpecialFlags);
```

#### Parameters

| Parameter                 | Description  |
|---------------------------|--|
| <code>x0</code>           | Leftmost pixel of the SCROLLBAR widget (in parent coordinates).  |
| <code>y0</code>           | Topmost pixel of the SCROLLBAR widget (in parent coordinates).   |
| <code>xSize</code>        | Horizontal size of the SCROLLBAR widget (in pixels).   |
| <code>ySize</code>        | Vertical size of the SCROLLBAR widget (in pixels).   |
| <code>hParent</code>      | Handle of parent window.   |
| <code>Id</code>           | ID to be returned.   |
| <code>WinFlags</code>     | Window create flags. Typically <code>WM_CF_SHOW</code> in order to make the widget visible immediately (refer to <i>Window create flags</i> on page 977 for a list of available parameter values). |
| <code>SpecialFlags</code> | Special creation flags. Permitted values are listed under <code>SCROLLBAR_CreateEx()</code> .  |

#### Return value

Handle of the created SCROLLBAR widget; 0 if the function fails.

### 6.2.34.3.5.3 SCROLLBAR\_CreateAttached()

#### Description

Creates a scroll bar which is attached to an existing window.

#### Prototype

```
SCROLLBAR_Handle SCROLLBAR_CreateAttached(WM_HWIN hParent,
                                           int SpecialFlags);
```

#### Parameters

| Parameter                 | Description   |
|---------------------------|---|
| <code>hParent</code>      | Handle of parent window.  |
| <code>SpecialFlags</code> | Special creation flags. Permitted values are listed under <code>SCROLLBAR_CreateEx()</code> . |

#### Return value

Handle of the created SCROLLBAR widget; 0 if the function fails.

#### Additional information

An attached SCROLLBAR widget is essentially a child window which will position itself on the parent window and operate accordingly. Vertical attached SCROLLBAR widgets will be automatically placed on the right side of the parent window; horizontal SCROLLBAR widgets on the bottom. Since no more than one horizontal and one vertical SCROLLBAR widget can be attached to a parent window, no ID needs to be passed as parameter. The following fixed ID's will automatically be assigned when an attached SCROLLBAR widget is created: `GUI_ID_HSCROLL` for a horizontal SCROLLBAR widget, and `GUI_ID_VSCROLL` for a vertical SCROLLBAR widget.

#### Example

Creates a list box with an attached SCROLLBAR widget:

```
LISTBOX_Handle hListBox;
hListBox = LISTBOX_Create(ListBox, 50, 50, 100, 100, WM_CF_SHOW);
SCROLLBAR_CreateAttached(hListBox, SCROLLBAR_CF_VERTICAL);
```

#### Screenshots of above example

The picture on the left shows the list box as it appears after creation. On the right it is shown with the attached vertical scroll bar:



### 6.2.34.3.5.4 SCROLLBAR\_CreateEx()

#### Description

Creates a SCROLLBAR widget of a specified size at a specified location.

#### Prototype

```
SCROLLBAR_Handle SCROLLBAR_CreateEx(int    x0,
                                     int    y0,
                                     int    xSize,
                                     int    ySize,
                                     WM_HWIN hParent,
                                     int    WinFlags,
                                     int    ExFlags,
                                     int    Id);
```

#### Parameters

| Parameter             | Description  |
|-----------------------|--|
| <code>x0</code>       | Leftmost pixel of the widget (in parent coordinates).  |
| <code>y0</code>       | Topmost pixel of the widget (in parent coordinates).   |
| <code>xSize</code>    | Horizontal size of the widget (in pixels).   |
| <code>ySize</code>    | Vertical size of the widget (in pixels).   |
| <code>hParent</code>  | Handle of parent window. If 0, the new SCROLLBAR widget will be a child of the desktop (top-level window).   |
| <code>WinFlags</code> | Window create flags. Typically <code>WM_CF_SHOW</code> in order to make the widget visible immediately (refer to <i>Window create flags</i> on page 977 for a list of available parameter values). |
| <code>ExFlags</code>  | OR-combination of special creation flags. See <i>SCROLLBAR create flags</i> on page 2450 for a list of permitted values.   |
| <code>Id</code>       | Window ID of the widget.   |

#### Return value

Handle of the created SCROLLBAR widget; 0 if the function fails.

### 6.2.34.3.5.5 SCROLLBAR\_CreateIndirect()

#### Description

The prototype of this function is explained at the beginning of this chapter. Details can be found in the description of the function `<WIDGET>_CreateIndirect()` on page 992. The element `Para` of the according `GUI_WIDGET_CREATE_INFO` structure is not used. The element `Flags` is used according to the parameter `ExFlags` of the function `SCROLLBAR_CreateEx()`.



### 6.2.34.3.5.6 SCROLLBAR\_CreateUser()

#### Description

Prototype explained at the beginning of the chapter as `<WIDGET>_CreateUser()` on page 993. For a detailed description of the parameters the function `SCROLLBAR_CreateEx()` can be referred to.

### 6.2.34.3.5.7 SCROLLBAR\_Dec()

#### Description

Decrements the current value of the given SCROLLBAR widget by a value of 1.

#### Prototype

```
void SCROLLBAR_Dec(SCROLLBAR_Handle hObj);
```

#### Parameters

| Parameter            | Description                   |
|----------------------|-------------------------------|
| <a href="#">hObj</a> | Handle of a SCROLLBAR widget. |

#### Additional information

The definition of an "item" is application-specific, although in most cases it is equal to one line. Items are numbered top to bottom or left to right, beginning with a value of 0.

### 6.2.34.3.5.8 SCROLLBAR\_GetColor()

#### Description

Returns the color attribute of the given SCROLLBAR widget.

#### Prototype

```
GUI_COLOR SCROLLBAR_GetColor(SCROLLBAR_Handle hObj,  
                              int Index);
```

#### Parameters

| Parameter             | Description  |
|-----------------------|--|
| <a href="#">hObj</a>  | Handle of a SCROLLBAR widget.  |
| <a href="#">Index</a> | See <i>SCROLLBAR color indexes</i> on page 2449 for a full list of permitted values. |

#### Return value

The color set for the different areas of the SCROLLBAR.

### 6.2.34.3.5.9 SCROLLBAR\_GetDefaultWidth()

#### Description

Returns the default width used to create a SCROLLBAR widget.

#### Prototype

```
int SCROLLBAR_GetDefaultWidth(void);
```

#### Return value

Default width used to create a SCROLLBAR widget.

### 6.2.34.3.5.10 SCROLLBAR\_GetNumItems()

#### Description

Returns the number of SCROLLBAR items.

#### Prototype

```
int SCROLLBAR_GetNumItems(SCROLLBAR_Handle hObj);
```

#### Parameters

| Parameter            | Description                   |
|----------------------|-------------------------------|
| <a href="#">hObj</a> | Handle of a SCROLLBAR widget. |

#### Return value

The number of SCROLLBAR items.

### 6.2.34.3.5.11 SCROLLBAR\_GetPageSize()

#### Description

Returns the page size.

#### Prototype

```
int SCROLLBAR_GetPageSize(SCROLLBAR_Handle hObj);
```

#### Parameters

| Parameter            | Description                   |
|----------------------|-------------------------------|
| <a href="#">hObj</a> | Handle of a SCROLLBAR widget. |

#### Return value

The number of items specified to be one page.

### 6.2.34.3.5.12 SCROLLBAR\_GetThumbSizeMin()

#### Description

Returns the minimum thumb size in pixels.

#### Prototype

```
int SCROLLBAR_GetThumbSizeMin(void);
```

#### Return value

Minimum thumb size in pixels.

### 6.2.34.3.5.13 SCROLLBAR\_GetUserData()

#### Description

Prototype explained at the beginning of the chapter as `<WIDGET>_GetUserData()` on page 994.



#### 6.2.34.3.5.14 SCROLLBAR\_GetValue()

##### Description

Returns the value of the current item.

##### Prototype

```
int SCROLLBAR_GetValue(SCROLLBAR_Handle hObj);
```

##### Parameters

| Parameter            | Description                   |
|----------------------|-------------------------------|
| <a href="#">hObj</a> | Handle of a SCROLLBAR widget. |

##### Return value

The value of the current item.

### 6.2.34.3.5.15 SCROLLBAR\_Inc()

#### Description

Increments the current value of the given SCROLLBAR widget by a value of 1.

#### Prototype

```
void SCROLLBAR_Inc(SCROLLBAR_Handle hObj);
```

#### Parameters

| Parameter            | Description                   |
|----------------------|-------------------------------|
| <a href="#">hObj</a> | Handle of a SCROLLBAR widget. |

#### Additional information

The definition of an "item" is application-specific, although in most cases it is equal to one line. Items are numbered top to bottom or left to right, beginning with a value of 0.

### 6.2.34.3.5.16 SCROLLBAR\_SetColor()

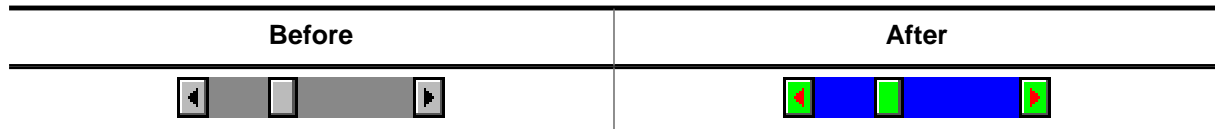

#### Description

Sets the color attribute of the given SCROLLBAR widget.

#### Prototype

```
GUI_COLOR SCROLLBAR_SetColor(SCROLLBAR_Handle hObj,
                              int Index,
                              GUI_COLOR Color);
```

#### Parameters

| Parameter             | Description  |
|-----------------------|--|
| <a href="#">hObj</a>  | Handle of a SCROLLBAR widget.  |
| <a href="#">Index</a> | See <i>SCROLLBAR color indexes</i> on page 2449 for a full list of permitted values. |
| <a href="#">Color</a> | <a href="#">Color</a> to be used.  |

#### Return value

Previous color used for the given index.

### 6.2.34.3.5.17 SCROLLBAR\_SetDefaultColor()

#### Description

Sets the default color attributes for new SCROLLBAR widgets.

#### Prototype

```
GUI_COLOR SCROLLBAR_SetDefaultColor(GUI_COLOR Color,  
                                     unsigned int Index);
```

#### Parameters

| Parameter             | Description  |
|-----------------------|--|
| <a href="#">Color</a> | <a href="#">Color</a> used as default for newly created SCROLLBAR widgets. |
| <a href="#">Index</a> | (see table under <i>SCROLLBAR_SetColor</i> on page 2439)                   |

#### Return value

Previous default color.

### 6.2.34.3.5.18 SCROLLBAR\_SetDefaultWidth()

#### Description

Sets the default width used to create a SCROLLBAR widget.

#### Prototype

```
int SCROLLBAR_SetDefaultWidth(int DefaultWidth);
```

#### Parameters

| Parameter    | Description                                     |
|--------------|---|
| DefaultWidth | Default width to use for new SCROLLBAR widgets. |

#### Return value

Previous default width.

### 6.2.34.3.5.19 SCROLLBAR\_SetNumItems()

#### Description

Sets the number of items for scrolling.

#### Prototype

```
void SCROLLBAR_SetNumItems(SCROLLBAR_Handle hObj,  
                           int NumItems);
```

#### Parameters

| Parameter             | Description                   |
|-----------------------|-------------------------------|
| <code>hObj</code>     | Handle of a SCROLLBAR widget. |
| <code>NumItems</code> | Number of items to be set.    |

#### Additional information

The definition of an "item" is application-specific, although in most cases it is equal to one line. The number of items is the maximum value. The SCROLLBAR widget can not go beyond this value.

### 6.2.34.3.5.20 SCROLLBAR\_SetPageSize()

#### Description

Sets the page size.

#### Prototype

```
void SCROLLBAR_SetPageSize(SCROLLBAR_Handle hObj,  
                           int              PageSize);
```

#### Parameters

| Parameter                | Description                     |
|--------------------------|---------------------------------|
| <a href="#">hObj</a>     | Handle of a SCROLLBAR widget.   |
| <a href="#">PageSize</a> | Page size (in number of items). |

#### Additional information

Page size is specified as the number of items to one page. If the user pages up or down, either with the keyboard or by mouse-clicking in the SCROLLBAR area, the window will be scrolled up or down by the number of items specified as one page.

### 6.2.34.3.5.21 SCROLLBAR\_SetState()

#### Description

Sets the state of a SCROLLBAR widget.

#### Prototype

```
void SCROLLBAR_SetState(      SCROLLBAR_Handle  hObj,  
                             const WM_SCROLL_STATE * pState);
```

#### Parameters

| Parameter           | Description  |
|---------------------|--|
| <code>hObj</code>   | Handle of a SCROLLBAR widget.                                      |
| <code>pState</code> | Pointer to a data structure of type <code>WM_SCROLL_STATE</code> . |



### 6.2.34.3.5.22 SCROLLBAR\_SetThumbSizeMin()

#### Description

Sets the minimum thumb size in pixels.

#### Prototype

```
int SCROLLBAR_SetThumbSizeMin(int ThumbSizeMin);
```

#### Parameters

| Parameter                    | Description                   |
|------------------------------|-------------------------------|
| <a href="#">ThumbSizeMin</a> | Minimum thumb size to be set. |

#### Return value

Old minimum thumb size in pixels.

### 6.2.34.3.5.23 SCROLLBAR\_SetUserData()

#### Description

Prototype explained at the beginning of the chapter as `<WIDGET>_SetUserData()` on page 995.

### 6.2.34.3.5.24 SCROLLBAR\_SetValue()

#### Description

Sets the value of the given SCROLLBAR widget.

#### Prototype

```
void SCROLLBAR_SetValue(SCROLLBAR_Handle hObj,  
                        int v);
```

#### Parameters

| Parameter         | Description                   |
|-------------------|-------------------------------|
| <code>hObj</code> | Handle of a SCROLLBAR widget. |
| <code>v</code>    | Value to be set.              |

### 6.2.34.3.5.25 SCROLLBAR\_SetWidth()

#### Description

Sets the width of the given SCROLLBAR widget.

#### Prototype

```
int SCROLLBAR_SetWidth(SCROLLBAR_Handle hObj,  
                       int Width);
```

#### Parameters

| Parameter          | Description                   |
|--------------------|-------------------------------|
| <code>hObj</code>  | Handle of a SCROLLBAR widget. |
| <code>Width</code> | <code>Width</code> to be set. |

### 6.2.34.3.5.26 SCROLLBAR color indexes

#### Description

Color indexes for SCROLLBAR widget.

#### Definition

```
#define SCROLLBAR_CI_THUMB    0
#define SCROLLBAR_CI_SHAFT   1
#define SCROLLBAR_CI_ARROW   2
```

#### Symbols

| Definition                         | Description          |
|------------------------------------|----------------------|
| <a href="#">SCROLLBAR_CI_THUMB</a> | Color of thumb area. |
| <a href="#">SCROLLBAR_CI_SHAFT</a> | Color of shaft.      |
| <a href="#">SCROLLBAR_CI_ARROW</a> | Color of arrows.     |

### 6.2.34.3.5.27 SCROLLBAR create flags

#### Description

These flags can be used when creating a SCROLLBAR widget via `SCROLLBAR_CreateEx()`. These values can be OR-combined.

#### Definition

```
#define SCROLLBAR_CF_VERTICAL      (1 << 3)
#define SCROLLBAR_CF_FOCUSABLE   (1 << 4)
```

#### Symbols

| Definition                             | Description                           |
|--|---------------------------------------|
| <a href="#">SCROLLBAR_CF_VERTICAL</a>  | Creates a vertical SCROLLBAR widget.  |
| <a href="#">SCROLLBAR_CF_FOCUSABLE</a> | Creates a focusable SCROLLBAR widget. |

### 6.2.34.3.6 Example

The `Sample` folder contains the following example which shows how the widget can be used:

- `WIDGET_ScrollbarMove.c`

Note that several other examples also make use of this widget and may also be helpful to get familiar with the widget.

#### Screenshot of `WIDGET_ScrollbarMove.c`

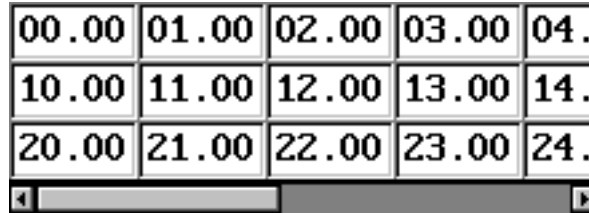

The screenshot displays a widget with a table of values and a scrollbar below it. The table has three rows and five columns. The values in the table are: 00.00, 01.00, 02.00, 03.00, 04. in the first row; 10.00, 11.00, 12.00, 13.00, 14. in the second row; and 20.00, 21.00, 22.00, 23.00, 24. in the third row. Below the table is a scrollbar with a left arrow and a right arrow.

|       |       |       |       |     |
|-------|-------|-------|-------|-----|
| 00.00 | 01.00 | 02.00 | 03.00 | 04. |
| 10.00 | 11.00 | 12.00 | 13.00 | 14. |
| 20.00 | 21.00 | 22.00 | 23.00 | 24. |

## 6.3 Dialogs

Widgets may be created and used on their own, as they are by nature windows themselves. However, it is often desirable to use dialog boxes, which are windows that contain one or more widgets.

A dialog box (or dialog) is normally a window that appears in order to request input from the user. It may contain multiple widgets, requesting information from the user through various selections, or it may take the form of a message box which simply provides information (such as a note or warning) and an "OK" button.

For common tasks like choosing a file, choosing a color or (as mentioned before) for showing simple text messages emWin offers 'common dialogs'. These dialogs can be configured to achieve the look and feel of the application.

### 6.3.1 Dialog basics

#### Input focus

The Window Manager remembers the window or window object that was last selected by the user with the touch-screen, mouse, keyboard, or other means. This window receives keyboard input messages and is said to have the input focus.

The primary reason for keeping track of input focus is to determine where to send keyboard commands. The window which has input focus will receive events generated by the keyboard.

To move the input focus within a dialog to the next focusable dialog item the key `GUI_KEY_TAB` can be used. To move backwards `GUI_KEY_BACKTAB` can be used.

#### Blocking vs. non-blocking dialogs

Dialog windows can be blocking or non-blocking.

A blocking dialog blocks the thread of execution. It has input focus by default and must be closed by the user before the thread can continue. A blocking dialog does not disable other dialogs shown at the same time. With other words a blocking dialog is not a modal dialog. Blocking means, the used functions (`GUI_ExecDialogBox()` or `GUI_ExecCreatedDialog()`) does not return until the dialog is closed.

A non-blocking dialog, on the other hand, does not block the calling thread—it allows the task to continue while it is visible. The function returns immediately after creating the dialog.

Blocking functions should never be called from within a callback function. This may cause malfunction of the application.

#### Dialog procedure

A dialog box is a window, and it receives messages just as every other window in the system does. Most messages are handled automatically by the client callback routine of the dialog box. The others are passed to the client callback routine which is specified as a parameter upon creation. The client callback function is known as the dialog procedure.

Since a dialog itself usually consists of 2 windows (dialog and client window), messages have to be sent using the correct handle. After a dialog was created there is only one handle to the dialog. In order to access the client window, the function `WM_GetClientWindow()` should be used.

#### Dialog messages

There are two types of additional messages which are sent to the dialog procedure: `WM_INIT_DIALOG` and `WM_NOTIFY_PARENT`. The `WM_INIT_DIALOG` message is sent to the dialog procedure immediately before a dialog box is displayed. Dialog procedures typically use this message to initialize widgets and carry out any other initialization tasks that affect the appearance of the dialog box. The `WM_NOTIFY_PARENT` message is sent to the dialog box by its child windows in order to notify the parent of any events in order to ensure syn-



chronization. The events sent by a child depend on its type and are documented separately for every type of widget.

## 6.3.2 Creating a dialog

Two basic things are required to create a dialog box: a resource table that defines the widgets to be included, and a dialog procedure which defines the initial values for the widgets as well as their behavior. Once both items exist, you need only a single function call (`GUI_CreateDialogBox()` or `GUI_ExecDialogBox()`) to actually create the dialog.

### 6.3.2.1 Resource table

Dialog boxes may be created in a blocking manner (using `GUI_ExecDialogBox()`) or as non-blocking (using `GUI_CreateDialogBox()`). A resource table must first be defined which specifies all widgets to be included in the dialog. The example shown below creates a resource table:

```
static const GUI_WIDGET_CREATE_INFO _aDialogCreate[] = {
  { FRAMEWIN_CreateIndirect, "Dialog", 0, 10, 10, 180, 230, 0, 0 },
  { BUTTON_CreateIndirect, "OK", GUI_ID_OK, 100, 5, 60, 20, 0, 0 },
  { BUTTON_CreateIndirect, "Cancel", GUI_ID_CANCEL, 100, 30, 60, 20, 0, 0 },
  { TEXT_CreateIndirect, "LText", 0, 10, 55, 48, 15, TEXT_CF_LEFT, 0 },
  { TEXT_CreateIndirect, "RText", 0, 10, 80, 48, 15, TEXT_CF_RIGHT, 0 },
  { EDIT_CreateIndirect, NULL, GUI_ID_EDIT0, 60, 55, 100, 15, 0, 50 },
  { EDIT_CreateIndirect, NULL, GUI_ID_EDIT1, 60, 80, 100, 15, 0, 50 },
  { TEXT_CreateIndirect, "Hex", 0, 10, 100, 48, 15, TEXT_CF_RIGHT, 0 },
  { EDIT_CreateIndirect, NULL, GUI_ID_EDIT2, 60, 100, 100, 15, 0, 6 },
  { TEXT_CreateIndirect, "Bin", 0, 10, 120, 48, 15, TEXT_CF_RIGHT, 0 },
  { EDIT_CreateIndirect, NULL, GUI_ID_EDIT3, 60, 120, 100, 15, 0, 0 },
  { LISTBOX_CreateIndirect, NULL, GUI_ID_LISTBOX0, 10, 10, 48, 40, 0, 0 },
  { CHECKBOX_CreateIndirect, NULL, GUI_ID_CHECK0, 10, 140, 0, 0, 0, 0 },
  { CHECKBOX_CreateIndirect, NULL, GUI_ID_CHECK1, 30, 140, 0, 0, 0, 0 },
  { SLIDER_CreateIndirect, NULL, GUI_ID_SLIDER0, 60, 140, 100, 20, 0, 0 },
  { SLIDER_CreateIndirect, NULL, GUI_ID_SLIDER1, 10, 170, 150, 30, 0, 0 }
};
```

Widgets can be included in a dialog by using the `<WIDGET>_CreateIndirect()` function for indirect creation. Detailed information can be found in the chapter *Widgets (window objects)* on page 982

### 6.3.2.2 Dialog procedure

The example above has been created using the blank dialog procedure shown below. This is the basic template which should be used as a starting point when creating any dialog procedure:

```
/*
 *
 *   Dialog procedure
 */
static void _cbCallback(WM_MESSAGE * pMsg) {
  switch (pMsg->MsgId) {
  default:
    WM_DefaultProc(pMsg);
  }
}
```

For this example, the dialog box is displayed with the following line of code:

```
GUI_ExecDialogBox(_aDialogCreate, GUI_COUNTOF(_aDialogCreate),
  _cbCallback, 0, 0, 0);
```

The resulting dialog box looks as follows, or similar (the actual appearance will depend on your configuration and default settings):

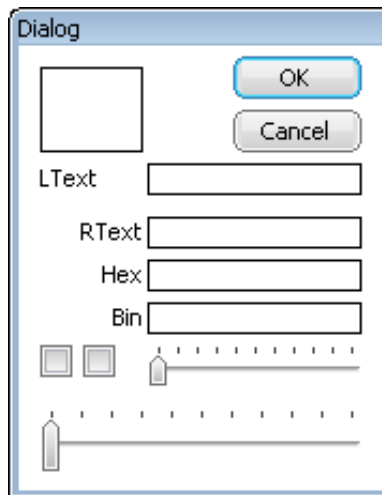

After creation of the dialog box, all widgets included in the resource table will be visible, although as can be seen in the previous screenshot, they will appear “empty”. This is because the dialog procedure does not yet contain code that initializes the individual elements. The initial values of the widgets, the actions caused by them, and the interactions between them need to be defined in the dialog procedure.

### 6.3.2.2.1 Initializing the dialog

The typical next step is to initialize the widgets with their respective initial values. This is normally done in the dialog procedure as a reaction to the `WM_INIT_DIALOG` message. The program excerpt below illustrates things:

```

/*****
 *
 *   Dialog procedure
 */
static void _cbCallback(WM_MESSAGE * pMsg) {
    WM_HWIN hItem;
    WM_HWIN hWin;
    hWin = pMsg->hWin;
    switch (pMsg->MsgId) {
    case WM_INIT_DIALOG:
        hItem = WM_GetDialogItem(hWin, GUI_ID_EDIT0);
        EDIT_SetText(hItem, "EDIT widget 0");
        hItem = WM_GetDialogItem(hWin, GUI_ID_EDIT1);
        EDIT_SetText(hItem, "EDIT widget 1");
        EDIT_SetTextAlign(hItem, GUI_TA_LEFT);
        hItem = WM_GetDialogItem(hWin, GUI_ID_EDIT2);
        EDIT_SetHexMode(hItem, 0x1234, 0, 0xffff);
        hItem = WM_GetDialogItem(hWin, GUI_ID_EDIT3);
        EDIT_SetBinMode(hItem, 0x1234, 0, 0xffff);
        hItem = WM_GetDialogItem(hWin, GUI_ID_CHECK0);
        CHECKBOX_Check(WM_GetDialogItem(hWin, GUI_ID_CHECK0));
        hItem = WM_GetDialogItem(hWin, GUI_ID_CHECK1);
        WM_DisableWindow(WM_GetDialogItem(hWin, GUI_ID_CHECK1));
        CHECKBOX_Check(WM_GetDialogItem(hWin, GUI_ID_CHECK1));
        hItem = WM_GetDialogItem(hWin, GUI_ID_SLIDER0);
        SLIDER_SetWidth(WM_GetDialogItem(hWin, GUI_ID_SLIDER0), 5);
        hItem = WM_GetDialogItem(hWin, GUI_ID_SLIDER1);
        SLIDER_SetValue(WM_GetDialogItem(hWin, GUI_ID_SLIDER1), 50);
        hItem = WM_GetDialogItem(hWin, GUI_ID_LISTBOX0);
        LISTBOX_SetText(hItem, _apListBox);
        break;
    default:
        WM_DefaultProc(pMsg);
    }
}

```

The initialized dialog box now appears as follows, with all widgets containing their initial values:

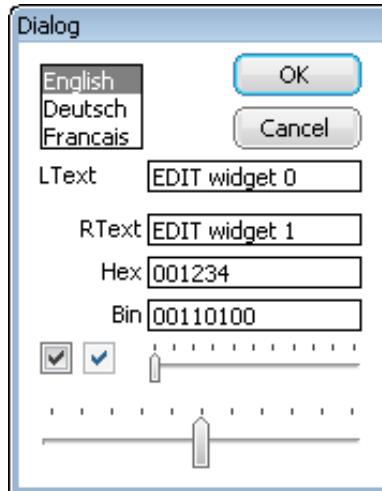

### 6.3.2.3 Defining dialog behavior

Once the dialog has been initialized, all that remains is to add code to the dialog procedure which will define the behavior of the widgets, making them fully operable. Continuing with the same example, the final dialog procedure is shown below:

```

/*****
*
*   Dialog procedure
*/
static void _cbCallback(WM_MESSAGE * pMsg) {
    WM_HWIN hEdit0, hEdit1, hEdit2, hEdit3;
    WM_HWIN hListBox;
    WM_HWIN hWin
    int   NCode
    int   Id;
    hWin = pMsg->hWin;
    switch (pMsg->MsgId) {
    case WM_INIT_DIALOG:
        /* Get window handles for all widgets */
        hEdit0 = WM_GetDialogItem(hWin, GUI_ID_EDIT0);
        hEdit1 = WM_GetDialogItem(hWin, GUI_ID_EDIT1);
        hEdit2 = WM_GetDialogItem(hWin, GUI_ID_EDIT2);
        hEdit3 = WM_GetDialogItem(hWin, GUI_ID_EDIT3);
        hListBox = WM_GetDialogItem(hWin, GUI_ID_LISTBOX0);
        /* Initialize all widgets */
        EDIT_SetText(hEdit0, "EDIT widget 0");
        EDIT_SetText(hEdit1, "EDIT widget 1");
        EDIT_SetTextAlign(hEdit1, GUI_TA_LEFT);
        EDIT_SetHexMode(hEdit2, 0x1234, 0, 0xffff);
        EDIT_SetBinMode(hEdit3, 0x1234, 0, 0xffff);
        LISTBOX_SetText(hListBox, _apListBox);
        WM_DisableWindow(WM_GetDialogItem(hWin, GUI_ID_CHECK1));
        CHECKBOX_Check( WM_GetDialogItem(hWin, GUI_ID_CHECK0));
        CHECKBOX_Check( WM_GetDialogItem(hWin, GUI_ID_CHECK1));
        SLIDER_SetWidth( WM_GetDialogItem(hWin, GUI_ID_SLIDER0), 5);
        SLIDER_SetValue( WM_GetDialogItem(hWin, GUI_ID_SLIDER1), 50);
        break;
    case WM_KEY:
        switch (((WM_KEY_INFO*)(pMsg->Data.p))->Key) {
        case GUI_ID_ESCAPE:
            GUI_EndDialog(hWin, 1);
            break;
        case GUI_ID_ENTER:
            GUI_EndDialog(hWin, 0);
            break;

```

```

    }
    break;
case WM_NOTIFY_PARENT:
    Id = WM_GetId(pMsg->hWinSrc);      /* Id of widget          */
    NCode = pMsg->Data.v;              /* Notification code     */
    switch (NCode) {
    case WM_NOTIFICATION_RELEASED:    /* React only if released */
        if (Id == GUI_ID_OK) {       /* OK Button             */
            GUI_EndDialog(hWin, 0);
        }
        if (Id == GUI_ID_CANCEL) {   /* Cancel Button         */
            GUI_EndDialog(hWin, 1);
        }
        break;
    case WM_NOTIFICATION_SEL_CHANGED: /* Selection changed     */
        FRAMEWIN_SetText(hWin, "Dialog - sel changed");
        break;
    default:
        FRAMEWIN_SetText(hWin, "Dialog - notification received");
    }
    break;
default:
    WM_DefaultProc(pMsg);
}
}
}

```

### 6.3.3 Dialog API

The table below lists the available dialog-related routines in alphabetical. Detailed descriptions follow:

| Routine                                 | Description                             |
|---|---|
| <a href="#">GUI_CreateDialogBox()</a>   | Creates a dialog box.                   |
| <a href="#">GUI_ExecCreatedDialog()</a> | Executes an already created dialog box. |
| <a href="#">GUI_ExecDialogBox()</a>     | Creates and executes a dialog box.      |
| <a href="#">GUI_EndDialog()</a>         | Ends (closes) a dialog box.             |

### 6.3.3.1 GUI\_CreateDialogBox()

#### Description

Creates a dialog box.

#### Prototype

```
WM_HWIN GUI_CreateDialogBox(const GUI_WIDGET_CREATE_INFO * paWidget,
                             int NumWidgets,
                             WM_CALLBACK * cb,
                             WM_HWIN hParent,
                             int x0,
                             int y0);
```

#### Parameters

| Parameter               | Description  |
|-------------------------|--|
| <code>paWidget</code>   | Pointer to resource table defining the widgets to be included in the dialog. |
| <code>NumWidgets</code> | Total number of widgets included in the dialog.                              |
| <code>cb</code>         | Pointer to an application-specific callback function (dialog procedure).     |
| <code>hParent</code>    | Handle of parent window (0 = no parent window).                              |
| <code>x0</code>         | X-position of the dialog relative to parent window.                          |
| <code>y0</code>         | Y-position of the dialog relative to parent window.                          |

#### Return value

Handle of the created dialog. This handle can be used to access the first widget from the resource table. This should be a FRAMEWIN or WINDOW widget.

#### Additional information

The parameter `cb` is used as callback function for the client window. If a callback function should be set for the dialog window, the function `WM_SetCallback()` should be used with the handle returned by `GUI_CreateDialogBox()`. The handle of the client window can be determined using the function `WM_GetClientWindow()` passing the handle of the dialog which was returned by `GUI_CreateDialogBox()`.

### 6.3.3.2 GUI\_ExecCreatedDialog()

#### Description

Executes an already created dialog box.

#### Prototype

```
int GUI_ExecCreatedDialog(WM_HWIN hDialog);
```

#### Parameters

| Parameter            | Description           |
|----------------------|-----------------------|
| <code>hDialog</code> | Handle to dialog box. |

#### Return value

Return value which was passed to `GUI_EndDialog()`.

#### Additional information

This is a blocking function. It does not return until the dialog is closed using the function `GUI_EndDialog()`. The `WM_CF_SHOW` flag is set, so the dialog is drawn the next time the Window Manager is executed.

### 6.3.3.3 GUI\_ExecDialogBox()

#### Description

Creates and executes a dialog box.

#### Prototype

```
int GUI_ExecDialogBox(const GUI_WIDGET_CREATE_INFO * paWidget,
                    int NumWidgets,
                    WM_CALLBACK * cb,
                    WM_HWIN hParent,
                    int x0,
                    int y0);
```

#### Parameters

| Parameter               | Description  |
|-------------------------|--|
| <code>paWidget</code>   | Pointer to a resource table defining the widgets to be included in the dialog. |
| <code>NumWidgets</code> | Total number of widgets included in the dialog.                                |
| <code>cb</code>         | Pointer to an application-specific callback function (dialog procedure).       |
| <code>hParent</code>    | Handle of parent window (0 = no parent window).                                |
| <code>x0</code>         | X-position of the dialog relative to parent window.                            |
| <code>y0</code>         | Y-position of the dialog relative to parent window.                            |

#### Return value

Return value which was passed to `GUI_EndDialog()`.

#### Additional information

This function actually calls `GUI_CreateDialogBox()` and `GUI_ExecCreatedDialog()`. It is blocking and therefore does not return until the dialog is closed using the function `GUI_EndDialog()`. The `WM_CF_SHOW` flag is set, so the dialog is drawn the next time the Window Manager is executed.

### 6.3.3.4 GUI\_EndDialog()

#### Description

Ends (closes) a dialog box. The dialog and its child windows will be removed from memory.

#### Prototype

```
void GUI_EndDialog(WM_HWIN hDialog,  
                  int r);
```

#### Parameters

| Parameter            | Description  |
|----------------------|--|
| <code>hDialog</code> | Handle to dialog box.  |
| <code>r</code>       | Value which is returned by the function <code>GUI_ExecDialog-Box()</code> . This value is ignored in case a non-blocking dialog is closed. |

#### Additional information

After the next call of `WM_Exec()` (gets also called in `GUI_Delay()`) the handle `hDialog` is no longer valid. Please note, that a `WM_DELETE` will be send delayed to the closed dialog.



## 6.3.4 CALENDAR dialog

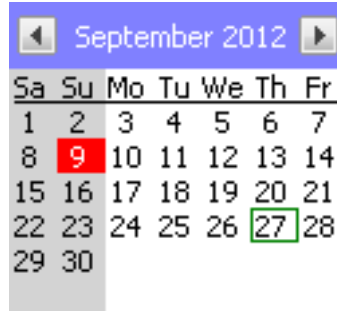

The CALENDAR dialog can be used for selecting or setting a date. The dialog consists of 2 buttons for month wise scrolling, a text which shows the current year and month and a pad of days. A small surrounding frame is shown surrounding the current date and the current selection is highlighted. The keyboard and/or the pointer input device (PID) can be used for selecting a date. The dialog supports the Gregorian calendar which is used since 1582.

The buttons to the left and right of month and year can be modified by using the IDs of the BUTTON widgets.

The left button uses the ID `GUI_ID_BUTTON0` and right one `GUI_ID_BUTTON1`. By calling the function `WM_GetDialogItem()` with the proper ID it is possible to receive the BUTTON handle and manage the buttons as any other BUTTON widget.

### 6.3.4.1 Notification codes

The following events are sent from the dialog to its parent window as part of a `WM_NOTIFY_PARENT` message:

| Message   | Description                                 |
|---|---|
| <code>CALENDAR_NOTIFICATION_MONTH_CLICKED</code>  | Month/year-text has been clicked.           |
| <code>CALENDAR_NOTIFICATION_MONTH_RELEASED</code> | Month/year-text has been released.          |
| <code>WM_NOTIFICATION_CLICKED</code>              | Widget has been clicked.                    |
| <code>WM_NOTIFICATION_RELEASED</code>             | Widget has been released.                   |
| <code>WM_NOTIFICATION_SCROLL_CHANGED</code>       | One of the scroll buttons has been pressed. |
| <code>WM_NOTIFICATION_SEL_CHANGED</code>          | The selection has been changed.             |

### 6.3.4.2 Keyboard reaction

| Key                         | Reaction                           |
|-----------------------------|------------------------------------|
| <code>GUI_KEY_PGUP</code>   | Selection moves one month back.    |
| <code>GUI_KEY_PGDOWN</code> | Selection moves one month forward. |
| <code>GUI_KEY_LEFT</code>   | Selection moves to the left.       |
| <code>GUI_KEY_RIGHT</code>  | Selection moves to the right.      |
| <code>GUI_KEY_UP</code>     | Selection moves one line up.       |
| <code>GUI_KEY_DOWN</code>   | Selection moves one line down.     |

### 6.3.4.3 CALENDAR\_API

The table below lists the available CALENDAR-related routines in alphabetical order. Detailed descriptions follow.

#### Functions

| Routine                                      | Description  |
|--|--|
| <a href="#">CALENDAR_AddKey()</a>            | Adds user input to a specified CALENDAR dialog.                        |
| <a href="#">CALENDAR_Create()</a>            | Creates a CALENDAR dialog.   |
| <a href="#">CALENDAR_GetDate()</a>           | Returns the current date.  |
| <a href="#">CALENDAR_GetDaysOfMonth()</a>    | Returns the number of days in a specific month.                        |
| <a href="#">CALENDAR_GetSel()</a>            | Returns the currently selected date.                                   |
| <a href="#">CALENDAR_GetWeekday()</a>        | Returns the number of the weekday of a given date.                     |
| <a href="#">CALENDAR_SetDate()</a>           | Sets the current date.   |
| <a href="#">CALENDAR_SetSel()</a>            | Sets the currently selected date.                                      |
| <a href="#">CALENDAR_SetDefaultBkColor()</a> | Sets the default background color to be used for new CALENDAR dialogs. |
| <a href="#">CALENDAR_SetDefaultColor()</a>   | Sets the default color to be used for new CALENDAR dialogs.            |
| <a href="#">CALENDAR_SetDefaultDays()</a>    | Sets the text to be used to label the days.                            |
| <a href="#">CALENDAR_SetDefaultFont()</a>    | Sets the font(s) to be used for drawing the CALENDAR items.            |
| <a href="#">CALENDAR_SetDefaultMonths()</a>  | Sets the text to be used for the current month / year.                 |
| <a href="#">CALENDAR_SetDefaultSize()</a>    | Sets the sizes to be used by the dialog.                               |
| <a href="#">CALENDAR_ShowDate()</a>          | Shows a given date on the calendar.                                    |

#### Data structures

| Structure                     | Description  |
|-------------------------------|--|
| <a href="#">CALENDAR_DATE</a> | Structure used by the routine <a href="#">CALENDAR_GetDate()</a> to retrieve a date. |

#### Defines

| Group of defines                       | Description  |
|--|--|
| <a href="#">CALENDAR color indexes</a> | Color indexes used by the CALENDAR dialog.                                   |
| <a href="#">CALENDAR font indexes</a>  | Font indexes used by the CALENDAR dialog.                                    |
| <a href="#">CALENDAR size indexes</a>  | Size indexes used by the routine <a href="#">CALENDAR_SetDefaultSize()</a> . |

### 6.3.4.3.1 Functions

#### 6.3.4.3.1.1 CALENDAR\_AddKey()

##### Description

Adds user input to a specified CALENDAR dialog.

##### Prototype

```
int CALENDAR_AddKey(WM_HWIN hWin,  
                    int      Key);
```

##### Parameters

| Parameter            | Description                |
|----------------------|----------------------------|
| <a href="#">hWin</a> | Handle of CALENDAR handle. |
| <a href="#">Key</a>  | Character to be added.     |

### 6.3.4.3.1.2 CALENDAR\_Create()

#### Description

Creates a CALENDAR dialog.

#### Prototype

```
WM_HWIN CALENDAR_Create(WM_HWIN hParent,
                        int xPos,
                        int yPos,
                        unsigned Year,
                        unsigned Month,
                        unsigned Day,
                        unsigned FirstDayOfWeek,
                        int Id,
                        int Flags);
```

#### Parameters

| Parameter                      | Description   |
|--------------------------------|---|
| <a href="#">hParent</a>        | Handle of the parent window which should receive the notification messages. |
| <a href="#">xPos</a>           | X position in pixels of the dialog in client coordinates.                   |
| <a href="#">yPos</a>           | Y position in pixels of the dialog in client coordinates.                   |
| <a href="#">Year</a>           | Current year (1582-9999).   |
| <a href="#">Month</a>          | Current month (1-12).   |
| <a href="#">Day</a>            | Current day (1-31).   |
| <a href="#">FirstDayOfWeek</a> | First weekday to be used (0=Saturday, 1=Sunday, ... , 6=Friday).            |
| <a href="#">Id</a>             | <a href="#">Id</a> to be used for the CALENDAR dialog.                      |
| <a href="#">Flags</a>          | Additional flags for the WINDOW widget.                                     |

#### Return value

Handle of the dialog on success, otherwise 0.

#### Additional information

[Year](#), [Month](#) and [Day](#) specify the current date. Per default this is also the initial selection. [FirstDayOfWeek](#) determines an offset for the first day to be shown. Default is showing Saturday at first.

### 6.3.4.3.1.3 CALENDAR\_GetDate()

#### Description

Returns the current date.

#### Prototype

```
void CALENDAR_GetDate(WM_HWIN hWin,  
                     CALENDAR_DATE * pDate);
```

#### Parameters

| Parameter          | Description                           |
|--------------------|---------------------------------------|
| <code>hWin</code>  | Handle of CALENDAR dialog.            |
| <code>pDate</code> | Pointer to a CALENDAR_DATE structure. |

#### Additional information

Current date and selected date are different items. The selection can be moved by the keyboard interface and/or the PID whereas the current date can be specified when creating the dialog or by using the function `CALENDAR_SetDate()`.

#### 6.3.4.3.1.4 CALENDAR\_GetDaysOfMonth()

##### Description

Returns the number of days in a specific month.

##### Prototype

```
int CALENDAR_GetDaysOfMonth(CALENDAR_DATE * pDate);
```

##### Parameters

| Parameter          | Description                           |
|--------------------|---------------------------------------|
| <code>pDate</code> | Pointer to a CALENDAR_DATE structure. |

##### Additional information

The members `Year` and `Month` of the parameter have to be set to get the number of days of the specified month in the specified year.

### 6.3.4.3.1.5 CALENDAR\_GetSel()

#### Description

Returns the currently selected date.

#### Prototype

```
void CALENDAR_GetSel(WM_HWIN hWin,  
                    CALENDAR_DATE * pDate);
```

#### Parameters

| Parameter          | Description                           |
|--------------------|---------------------------------------|
| <code>hWin</code>  | Handle of CALENDAR dialog.            |
| <code>pDate</code> | Pointer to a CALENDAR_DATE structure. |

### 6.3.4.3.1.6 CALENDAR\_GetWeekday()

#### Description

Returns the number of the weekday of a given date.

#### Prototype

```
int CALENDAR_GetWeekday(CALENDAR_DATE * pDate);
```

#### Parameters

| Parameter          | Description                         |
|--------------------|-------------------------------------|
| <code>pDate</code> | Pointer to CALENDAR_DATE structure. |

#### Return value

|   |           |
|---|-----------|
| 0 | Saturday  |
| 1 | Sunday    |
| 2 | Monday    |
| 3 | Tuesday   |
| 4 | Wednesday |
| 5 | Thursday  |
| 6 | Friday    |

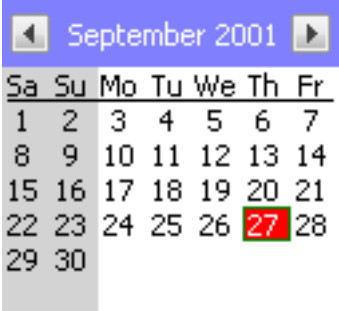
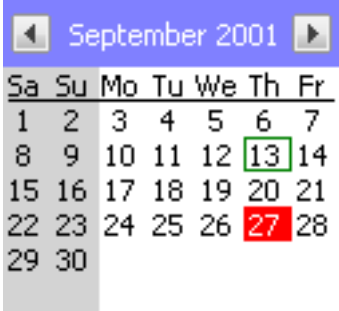

### 6.3.4.3.1.7 CALENDAR\_SetDate()

| Before  | After  |
|---|--|
|  |  |

#### Description

Sets the current date.

#### Prototype

```
void CALENDAR_SetDate(WM_HWIN          hWin,
                     CALENDAR_DATE * pDate);
```

#### Parameters

| Parameter          | Description                           |
|--------------------|---------------------------------------|
| <code>hWin</code>  | Handle of CALENDAR dialog.            |
| <code>pDate</code> | Pointer to a CALENDAR_DATE structure. |

### 6.3.4.3.1.8 CALENDAR\_SetSel()

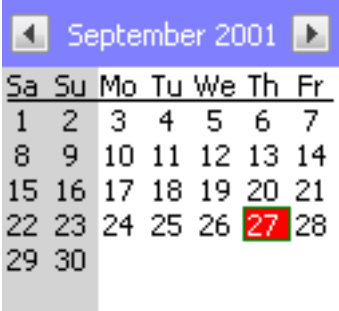
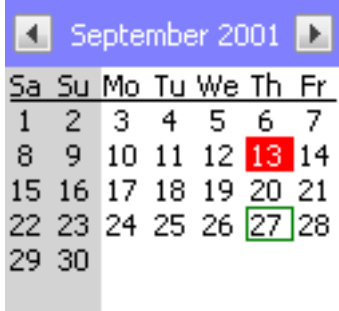
| Before   | After |    |    |    |    |    |    |   |   |   |   |   |   |   |   |   |    |    |    |    |    |    |    |    |    |    |    |    |    |    |    |    |    |    |    |    |    |  |  |  |  |  |   |    |    |    |    |    |    |    |   |   |   |   |   |   |   |   |   |    |    |    |    |    |    |    |    |    |    |    |    |    |    |    |    |    |    |    |    |    |  |  |  |  |  |
|--|-------|----|----|----|----|----|----|---|---|---|---|---|---|---|---|---|----|----|----|----|----|----|----|----|----|----|----|----|----|----|----|----|----|----|----|----|----|--|--|--|--|--|---|----|----|----|----|----|----|----|---|---|---|---|---|---|---|---|---|----|----|----|----|----|----|----|----|----|----|----|----|----|----|----|----|----|----|----|----|----|--|--|--|--|--|
|  <p>September 2001</p> <table border="1"> <thead> <tr> <th>Sa</th> <th>Su</th> <th>Mo</th> <th>Tu</th> <th>We</th> <th>Th</th> <th>Fr</th> </tr> </thead> <tbody> <tr><td>1</td><td>2</td><td>3</td><td>4</td><td>5</td><td>6</td><td>7</td></tr> <tr><td>8</td><td>9</td><td>10</td><td>11</td><td>12</td><td>13</td><td>14</td></tr> <tr><td>15</td><td>16</td><td>17</td><td>18</td><td>19</td><td>20</td><td>21</td></tr> <tr><td>22</td><td>23</td><td>24</td><td>25</td><td>26</td><td>27</td><td>28</td></tr> <tr><td>29</td><td>30</td><td></td><td></td><td></td><td></td><td></td></tr> </tbody> </table> | Sa    | Su | Mo | Tu | We | Th | Fr | 1 | 2 | 3 | 4 | 5 | 6 | 7 | 8 | 9 | 10 | 11 | 12 | 13 | 14 | 15 | 16 | 17 | 18 | 19 | 20 | 21 | 22 | 23 | 24 | 25 | 26 | 27 | 28 | 29 | 30 |  |  |  |  |  |  <p>September 2001</p> <table border="1"> <thead> <tr> <th>Sa</th> <th>Su</th> <th>Mo</th> <th>Tu</th> <th>We</th> <th>Th</th> <th>Fr</th> </tr> </thead> <tbody> <tr><td>1</td><td>2</td><td>3</td><td>4</td><td>5</td><td>6</td><td>7</td></tr> <tr><td>8</td><td>9</td><td>10</td><td>11</td><td>12</td><td>13</td><td>14</td></tr> <tr><td>15</td><td>16</td><td>17</td><td>18</td><td>19</td><td>20</td><td>21</td></tr> <tr><td>22</td><td>23</td><td>24</td><td>25</td><td>26</td><td>27</td><td>28</td></tr> <tr><td>29</td><td>30</td><td></td><td></td><td></td><td></td><td></td></tr> </tbody> </table> | Sa | Su | Mo | Tu | We | Th | Fr | 1 | 2 | 3 | 4 | 5 | 6 | 7 | 8 | 9 | 10 | 11 | 12 | 13 | 14 | 15 | 16 | 17 | 18 | 19 | 20 | 21 | 22 | 23 | 24 | 25 | 26 | 27 | 28 | 29 | 30 |  |  |  |  |  |
| Sa   | Su    | Mo | Tu | We | Th | Fr |    |   |   |   |   |   |   |   |   |   |    |    |    |    |    |    |    |    |    |    |    |    |    |    |    |    |    |    |    |    |    |  |  |  |  |  |   |    |    |    |    |    |    |    |   |   |   |   |   |   |   |   |   |    |    |    |    |    |    |    |    |    |    |    |    |    |    |    |    |    |    |    |    |    |  |  |  |  |  |
| 1  | 2     | 3  | 4  | 5  | 6  | 7  |    |   |   |   |   |   |   |   |   |   |    |    |    |    |    |    |    |    |    |    |    |    |    |    |    |    |    |    |    |    |    |  |  |  |  |  |   |    |    |    |    |    |    |    |   |   |   |   |   |   |   |   |   |    |    |    |    |    |    |    |    |    |    |    |    |    |    |    |    |    |    |    |    |    |  |  |  |  |  |
| 8  | 9     | 10 | 11 | 12 | 13 | 14 |    |   |   |   |   |   |   |   |   |   |    |    |    |    |    |    |    |    |    |    |    |    |    |    |    |    |    |    |    |    |    |  |  |  |  |  |   |    |    |    |    |    |    |    |   |   |   |   |   |   |   |   |   |    |    |    |    |    |    |    |    |    |    |    |    |    |    |    |    |    |    |    |    |    |  |  |  |  |  |
| 15   | 16    | 17 | 18 | 19 | 20 | 21 |    |   |   |   |   |   |   |   |   |   |    |    |    |    |    |    |    |    |    |    |    |    |    |    |    |    |    |    |    |    |    |  |  |  |  |  |   |    |    |    |    |    |    |    |   |   |   |   |   |   |   |   |   |    |    |    |    |    |    |    |    |    |    |    |    |    |    |    |    |    |    |    |    |    |  |  |  |  |  |
| 22   | 23    | 24 | 25 | 26 | 27 | 28 |    |   |   |   |   |   |   |   |   |   |    |    |    |    |    |    |    |    |    |    |    |    |    |    |    |    |    |    |    |    |    |  |  |  |  |  |   |    |    |    |    |    |    |    |   |   |   |   |   |   |   |   |   |    |    |    |    |    |    |    |    |    |    |    |    |    |    |    |    |    |    |    |    |    |  |  |  |  |  |
| 29   | 30    |    |    |    |    |    |    |   |   |   |   |   |   |   |   |   |    |    |    |    |    |    |    |    |    |    |    |    |    |    |    |    |    |    |    |    |    |  |  |  |  |  |   |    |    |    |    |    |    |    |   |   |   |   |   |   |   |   |   |    |    |    |    |    |    |    |    |    |    |    |    |    |    |    |    |    |    |    |    |    |  |  |  |  |  |
| Sa   | Su    | Mo | Tu | We | Th | Fr |    |   |   |   |   |   |   |   |   |   |    |    |    |    |    |    |    |    |    |    |    |    |    |    |    |    |    |    |    |    |    |  |  |  |  |  |   |    |    |    |    |    |    |    |   |   |   |   |   |   |   |   |   |    |    |    |    |    |    |    |    |    |    |    |    |    |    |    |    |    |    |    |    |    |  |  |  |  |  |
| 1  | 2     | 3  | 4  | 5  | 6  | 7  |    |   |   |   |   |   |   |   |   |   |    |    |    |    |    |    |    |    |    |    |    |    |    |    |    |    |    |    |    |    |    |  |  |  |  |  |   |    |    |    |    |    |    |    |   |   |   |   |   |   |   |   |   |    |    |    |    |    |    |    |    |    |    |    |    |    |    |    |    |    |    |    |    |    |  |  |  |  |  |
| 8  | 9     | 10 | 11 | 12 | 13 | 14 |    |   |   |   |   |   |   |   |   |   |    |    |    |    |    |    |    |    |    |    |    |    |    |    |    |    |    |    |    |    |    |  |  |  |  |  |   |    |    |    |    |    |    |    |   |   |   |   |   |   |   |   |   |    |    |    |    |    |    |    |    |    |    |    |    |    |    |    |    |    |    |    |    |    |  |  |  |  |  |
| 15   | 16    | 17 | 18 | 19 | 20 | 21 |    |   |   |   |   |   |   |   |   |   |    |    |    |    |    |    |    |    |    |    |    |    |    |    |    |    |    |    |    |    |    |  |  |  |  |  |   |    |    |    |    |    |    |    |   |   |   |   |   |   |   |   |   |    |    |    |    |    |    |    |    |    |    |    |    |    |    |    |    |    |    |    |    |    |  |  |  |  |  |
| 22   | 23    | 24 | 25 | 26 | 27 | 28 |    |   |   |   |   |   |   |   |   |   |    |    |    |    |    |    |    |    |    |    |    |    |    |    |    |    |    |    |    |    |    |  |  |  |  |  |   |    |    |    |    |    |    |    |   |   |   |   |   |   |   |   |   |    |    |    |    |    |    |    |    |    |    |    |    |    |    |    |    |    |    |    |    |    |  |  |  |  |  |
| 29   | 30    |    |    |    |    |    |    |   |   |   |   |   |   |   |   |   |    |    |    |    |    |    |    |    |    |    |    |    |    |    |    |    |    |    |    |    |    |  |  |  |  |  |   |    |    |    |    |    |    |    |   |   |   |   |   |   |   |   |   |    |    |    |    |    |    |    |    |    |    |    |    |    |    |    |    |    |    |    |    |    |  |  |  |  |  |

#### Description

Sets the currently selected date.

#### Prototype

```
void CALENDAR_SetSel(WM_HWIN          hWin,
                    CALENDAR_DATE * pDate);
```

#### Parameters

| Parameter          | Description                           |
|--------------------|---------------------------------------|
| <code>hWin</code>  | Handle of CALENDAR dialog.            |
| <code>pDate</code> | Pointer to a CALENDAR_DATE structure. |

### 6.3.4.3.1.9 CALENDAR\_SetDefaultBkColor()

#### Description

Sets the default background color to be used for new CALENDAR dialogs.

#### Prototype

```
void CALENDAR_SetDefaultBkColor(unsigned Index,  
                                GUI_COLOR Color);
```

#### Parameters

| Parameter             | Description   |
|-----------------------|---|
| <a href="#">Index</a> | See <i>CALENDAR color indexes</i> on page 2479. Only <b>...WEEK-END</b> , <b>...WEEKDAY</b> , <b>...SEL</b> and <b>...HEADER</b> are applicable for a background color. |
| <a href="#">Color</a> | <a href="#">Color</a> to be used  |

### 6.3.4.3.1.10 CALENDAR\_SetDefaultColor()

#### Description

Sets the default color to be used for new CALENDAR dialogs.

#### Prototype

```
void CALENDAR_SetDefaultColor(unsigned Index,  
                             GUI_COLOR Color);
```

#### Parameters

| Parameter             | Description   |
|-----------------------|---|
| <a href="#">Index</a> | See <i>CALENDAR color indexes</i> on page 2479. <b>CALENDAR_CI_HEADER</b> is not applicable for this routine. |
| <a href="#">Color</a> | <a href="#">Color</a> to be used  |

### 6.3.4.3.1.11 CALENDAR\_SetDefaultDays()

#### Description

Sets the text to be used to label the days.

#### Prototype

```
void CALENDAR_SetDefaultDays(const char ** apDays);
```

#### Parameters

| Parameter           | Description   |
|---------------------|---|
| <code>apDays</code> | Pointer to an array of 7 string pointers containing the strings to be used. |

#### Additional information

The first string of the array should point to the abbreviation of Saturday, the second to Sunday and so on. The array needs to have at least 7 strings. If there are too few strings passed to the function the behavior of emWin becomes undefined.

### 6.3.4.3.1.12 CALENDAR\_SetDefaultFont()

#### Description

Sets the font(s) to be used for drawing the CALENDAR items.

#### Prototype

```
void CALENDAR_SetDefaultFont(    unsigned   Index,  
                                const GUI_FONT * pFont);
```

#### Parameters

| Parameter             | Description  |
|-----------------------|--|
| <a href="#">Index</a> | See <i>CALENDAR font indexes</i> on page 2480 for a full list of permitted values. |
| <a href="#">pFont</a> | Font to be used.   |

### 6.3.4.3.1.13 CALENDAR\_SetDefaultMonths()

#### Description

Sets the text to be used for the current month / year.

#### Prototype

```
void CALENDAR_SetDefaultMonths(const char ** apMonths);
```

#### Parameters

| Parameter            | Description  |
|----------------------|--|
| <code>apMonth</code> | Pointer to an array of 12 string pointers containing the strings to be used. |

#### Additional information

The first string of the array should point to the text for 'January', the second to the text for 'February' and so on. The array needs to have at least 12 strings. If there are too few strings passed to the function the behavior of emWin becomes undefined.

### 6.3.4.3.1.14 CALENDAR\_SetDefaultSize()

#### Description

Sets the sizes to be used by the dialog.

#### Prototype

```
void CALENDAR_SetDefaultSize(unsigned Index,  
                             unsigned Size);
```

#### Parameters

| Parameter             | Description  |
|-----------------------|--|
| <a href="#">Index</a> | See <i>CALENDAR size indexes</i> on page 2481 for a full list of permitted values. |
| <a href="#">Size</a>  | <a href="#">Size</a> to be used.   |

#### Additional information

The size in x of the complete dialog can be calculated as follows:  $xSizeDialog = 7 * CellSizeX$   
The size in y of the complete dialog can be calculated as follows:  $ySizeDialog = 7 * CellSizeY + HeaderSizeY$



### 6.3.4.3.1.15 CALENDAR\_ShowDate()

#### Description

Shows a given date on the calendar.

#### Prototype

```
void CALENDAR_ShowDate(WM_HWIN      hWin,  
                       CALENDAR_DATE * pDate);
```

#### Parameters

| Parameter          | Description                           |
|--------------------|---------------------------------------|
| <code>hWin</code>  | Handle of CALENDAR dialog.            |
| <code>pDate</code> | Pointer to a CALENDAR_DATE structure. |

### 6.3.4.3.2 Data structures

#### 6.3.4.3.2.1 CALENDAR\_DATE

##### Description

Structure used by the routine `CALENDAR_GetDate()` to retrieve a date.

##### Type definition

```
typedef struct {  
    int Year;  
    int Month;  
    int Day;  
} CALENDAR_DATE;
```

##### Structure members

| Member             | Description                           |
|--------------------|---------------------------------------|
| <code>Year</code>  | <code>Year</code> of requested date.  |
| <code>Month</code> | <code>Month</code> of requested date. |
| <code>Day</code>   | <code>Day</code> of requested date.   |

### 6.3.4.3.3 Defines

#### 6.3.4.3.3.1 CALENDAR color indexes

##### Description

Color indexes used by the CALENDAR dialog.

##### Definition

```
#define CALENDAR_CI_WEEKEND    0
#define CALENDAR_CI_WEEKDAY    1
#define CALENDAR_CI_SEL        2
#define CALENDAR_CI_HEADER     3
#define CALENDAR_CI_MONTH      4
#define CALENDAR_CI_LABEL      5
#define CALENDAR_CI_FRAME      6
```

##### Symbols

| Definition          | Description   |
|---------------------|---|
| CALENDAR_CI_WEEKEND | Color to be used for weekend days.                  |
| CALENDAR_CI_WEEKDAY | Color to be used for weekdays.                      |
| CALENDAR_CI_SEL     | Color to be used for the selection.                 |
| CALENDAR_CI_HEADER  | Background color to be used for the header area.    |
| CALENDAR_CI_MONTH   | Color to be used for the month (and year) text.     |
| CALENDAR_CI_LABEL   | Color to be used for labeling the days.             |
| CALENDAR_CI_FRAME   | Color to be used for the frame of the current date. |

### 6.3.4.3.3.2 CALENDAR font indexes

#### Description

Font indexes used by the CALENDAR dialog.

#### Definition

```
#define CALENDAR_FI_CONTENT    0
#define CALENDAR_FI_HEADER    1
```

#### Symbols

| Definition                          | Description                                   |
|-------------------------------------|---|
| <a href="#">CALENDAR_FI_CONTENT</a> | Font to be used for labeling and the numbers. |
| <a href="#">CALENDAR_FI_HEADER</a>  | Font to be used for month / year.             |

### 6.3.4.3.3 CALENDAR size indexes

#### Description

Size indexes used by the routine `CALENDAR_SetDefaultSize()`.

#### Definition

```
#define CALENDAR_SI_HEADER    0
#define CALENDAR_SI_CELL_X   1
#define CALENDAR_SI_CELL_Y   2
```

#### Symbols

| Definition                         | Description  |
|------------------------------------|--|
| <a href="#">CALENDAR_SI_HEADER</a> | Y-size in pixels used for the header area. (default is 25)             |
| <a href="#">CALENDAR_SI_CELL_X</a> | Cell size in X to be used for one item in the day pad. (default is 18) |
| <a href="#">CALENDAR_SI_CELL_Y</a> | Cell size in Y to be used for one item in the day pad. (default is 13) |

## 6.3.5 CHOOSECOLOR dialog



The CHOOSECOLOR dialog can be used to select a color from a given color array.

### 6.3.5.1 Notification codes

The following events are sent from the dialog to its parent window as part of a WM\_NOTIFY\_PARENT message:

| Message                       | Description  |
|-------------------------------|--|
| WM_NOTIFICATION_SEL_CHANGED   | Sent immediately after a new color has been selected by the PID or the keyboard.                 |
| WM_NOTIFICATION_CHILD_DELETED | Sent when the dialog has been closed.  |
| WM_NOTIFICATION_VALUE_CHANGED | Sent if the dialog was closed using the 'Ok' button with a different than the initial selection. |

### 6.3.5.2 Keyboard reaction

The dialog reacts to the following keys if it has the input focus:

| Key            | Reaction                                |
|----------------|---|
| GUI_KEY_ESCAPE | Dialog execution will be canceled.      |
| GUI_KEY_ENTER  | Reaction depends on the focused button. |
| GUI_KEY_LEFT   | Cursor moves to the left.               |
| GUI_KEY_RIGHT  | Cursor moves to the right.              |
| GUI_KEY_UP     | Cursor moves one line up.               |
| GUI_KEY_DOWN   | Cursor moves one line down.             |

### 6.3.5.3 CHOOSECOLOR API

The table below lists the available CHOOSECOLOR-related routines in alphabetical order. Detailed descriptions follow.

#### Functions

| Routine   | Description   |
|---|---|
| <code>CHOOSECOLOR_Create()</code>               | Creates a dialog for choosing a color and returns immediately.                  |
| <code>CHOOSECOLOR_GetSel()</code>               | Returns the index of the currently selected color.                              |
| <code>CHOOSECOLOR_SetSel()</code>               | Sets the current selection.   |
| <code>CHOOSECOLOR_SetDefaultColor()</code>      | Sets the colors to be used to draw the surrounding frame of the colors.         |
| <code>CHOOSECOLOR_SetDefaultSpace()</code>      | Determines the space between the color rectangles.                              |
| <code>CHOOSECOLOR_SetDefaultBorder()</code>     | Sets the size of the border between the colors and the dialog frame to be used. |
| <code>CHOOSECOLOR_SetDefaultButtonSize()</code> | Sets the button size to be used.  |

#### Defines

| Group of defines                       | Description                                   |
|--|---|
| <code>CHOOSECOLOR_color_indexes</code> | Color indexes used by the CHOOSECOLOR dialog. |

### 6.3.5.3.1 Functions

#### 6.3.5.3.1.1 CHOOSECOLOR\_Create()

##### Description

Creates a dialog for choosing a color and returns immediately.

##### Prototype

```
WM_HWIN CHOOSECOLOR_Create(
    WM_HWIN    hParent,
    int        xPos,
    int        yPos,
    int        xSize,
    int        ySize,
    const GUI_COLOR * pColor,
    unsigned   NumColors,
    unsigned   NumColorsPerLine,
    int        Sel,
    const char * sCaption,
    int        Flags);
```

##### Parameters

| Parameter                     | Description  |
|-------------------------------|--|
| <code>hParent</code>          | Handle of the parent window which should receive the notification messages.  |
| <code>xPos</code>             | X position in pixels of the dialog in client coordinates.                    |
| <code>yPos</code>             | Y position in pixels of the dialog in client coordinates.                    |
| <code>xSize</code>            | X-size of the dialog in pixels.  |
| <code>ySize</code>            | Y-size of the dialog in pixels.  |
| <code>pColor</code>           | Pointer to an array of 32 bit color values containing the colors to be used. |
| <code>NumColors</code>        | Number of colors to be shown.  |
| <code>NumColorsPerLine</code> | Number of colors to be shown per line.                                       |
| <code>Sel</code>              | Initial index value to be used for the selection / focus.                    |
| <code>sCaption</code>         | Title to be shown in the title bar.  |
| <code>Flags</code>            | Additional flags for the FRAMEWIN widget.                                    |

##### Return value

Handle of the dialog on success, otherwise 0.

##### Additional information

The following default values are used:

- If (`xPos < 0`) the dialog will be centered horizontally.
- If (`yPos < 0`) the dialog will be centered vertically.
- If (`xSize = 0`) the half of the display size in x will be used.
- If (`ySize = 0`) the half of the display size in y will be used.
- if (`sCaption = NULL`) 'Choose Color' will be shown in the title bar. As mentioned above the creation routine returns immediately. It becomes visible with the next call of `WM_Exec()` or it can be executed with `GUI_ExecCreatedDialog()`.



### 6.3.5.3.1.2 CHOOSECOLOR\_GetSel()

#### Description

Returns the index of the currently selected color.

#### Prototype

```
int CHOOSECOLOR_GetSel(WM_HWIN hObj);
```

#### Parameters

| Parameter            | Description                       |
|----------------------|-----------------------------------|
| <a href="#">hObj</a> | Handle of the CHOOSECOLOR dialog. |

#### Return value

Index of the currently selected color.

### 6.3.5.3.1.3 CHOOSECOLOR\_SetSel()

#### Description

Sets the current selection.

#### Prototype

```
void CHOOSECOLOR_SetSel(WM_HWIN hObj,  
                        int Sel);
```

#### Parameters

| Parameter         | Description                       |
|-------------------|-----------------------------------|
| <code>hObj</code> | Handle of the CHOOSECOLOR dialog. |
| <code>Sel</code>  | New selection to be used.         |

#### Additional information

The given selection should be smaller than the number of colors. In case of a negative value no initial selection will be shown.

### 6.3.5.3.1.4 CHOOSECOLOR\_SetDefaultColor()

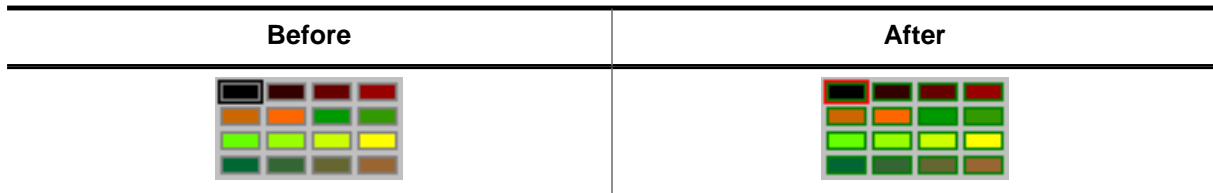

#### Description

Sets the colors to be used to draw the surrounding frame of the colors.

#### Prototype

```
void CHOOSECOLOR_SetDefaultColor(unsigned Index,
                                  GUI_COLOR Color);
```

#### Parameters

| Parameter             | Description  |
|-----------------------|--|
| <a href="#">Index</a> | See <i>CHOOSECOLOR color indexes</i> on page 2491 for a full list of permitted values. |
| <a href="#">Color</a> | <a href="#">Color</a> to be used.  |

### 6.3.5.3.1.5 CHOOSECOLOR\_SetDefaultSpace()

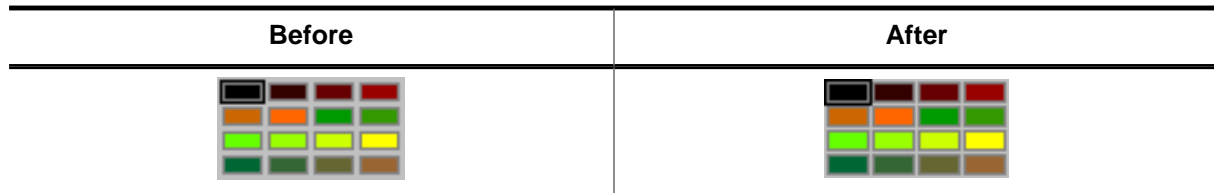

#### Description

Determines the space between the color rectangles.

#### Prototype

```
void CHOOSECOLOR_SetDefaultSpace(unsigned Index,
                                  unsigned Space);
```

#### Parameters

| Parameter   | Description  |
|---|--|
| <a href="#">Index</a>                                       | See table below.   |
| <a href="#">Space</a>                                       | <a href="#">Space</a> in pixels to be used.                                      |
| <b>Permitted values for parameter <a href="#">Index</a></b> |  |
| GUI_COORD_X   | <a href="#">Space</a> in X to be used between the colors.<br>Default value is 5. |
| GUI_COORD_Y   | <a href="#">Space</a> in Y to be used between the colors.<br>Default value is 5. |

### 6.3.5.3.1.6 CHOOSECOLOR\_SetDefaultBorder()



#### Description

Sets the size of the border between the colors and the dialog frame to be used.

#### Prototype

```
void CHOOSECOLOR_SetDefaultBorder(unsigned Index,
                                   unsigned Border);
```

#### Parameters

| Parameter              | Description                        |
|------------------------|------------------------------------|
| <a href="#">Index</a>  | See table below.                   |
| <a href="#">Border</a> | <a href="#">Border</a> to be used. |

| Permitted values for parameter <a href="#">Index</a> |  |
|--|--|
| GUI_COORD_X  | Space in X to be used between border and colors. Default value is 4. |
| GUI_COORD_Y  | Space in Y to be used between border and colors. Default value is 4. |

#### Additional information

The horizontal value is also used to determine the space between the buttons.

### 6.3.5.3.1.7 CHOOSECOLOR\_SetDefaultButtonSize()

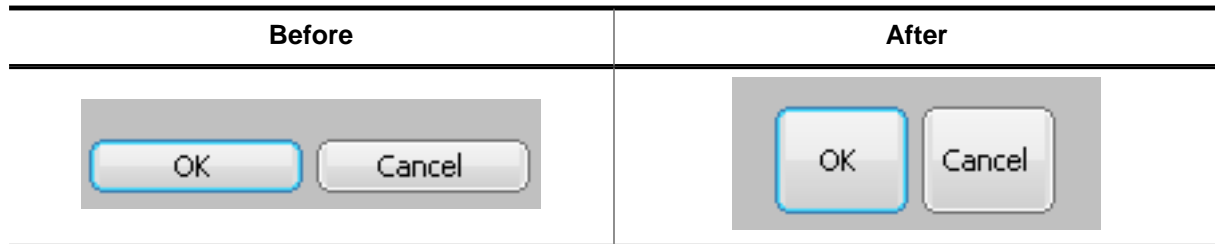

#### Description

Sets the button size to be used.

#### Prototype

```
void CHOOSECOLOR_SetDefaultButtonSize(unsigned Index,
                                       unsigned ButtonSize);
```

#### Parameters

| Parameter  | Description                |
|--|----------------------------|
| <a href="#">Index</a>                                | See table below.           |
| <a href="#">ButtonSize</a>                           | Size in pixels to be used. |
| Permitted values for parameter <a href="#">Index</a> |                            |
| GUI_COORD_X  | Button size in X.          |
| GUI_COORD_Y  | Button size in Y.          |

### 6.3.5.3.2 Defines

#### 6.3.5.3.2.1 CHOOSECOLOR color indexes

##### Description

Color indexes used by the CHOOSECOLOR dialog.

##### Definition

```
#define CHOOSECOLOR_CI_FRAME    0
#define CHOOSECOLOR_CI_FOCUS   1
```

##### Symbols

| Definition                           | Description   |
|--------------------------------------|---|
| <a href="#">CHOOSECOLOR_CI_FRAME</a> | Color to be used to draw the frame surrounding each color. Default is GUI_GRAY. |
| <a href="#">CHOOSECOLOR_CI_FOCUS</a> | Color to be used to draw the focus rectangle. Default is GUI_BLACK.             |

### 6.3.6 CHOOSEFILE dialog

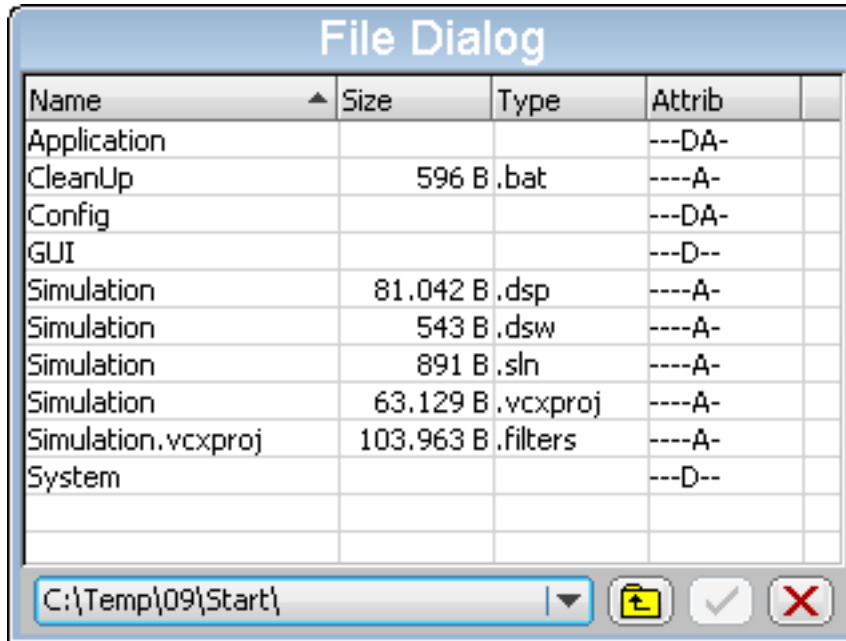

The CHOOSEFILE dialog can be used for browsing through a directory and for selecting a file. It uses a user defined callback routine for retrieving data. So it can be used with any file system.

#### 6.3.6.1 Configuring options

| Type | Macro            | Default | Description                   |
|------|------------------|---------|-------------------------------|
| N    | CHOOSEFILE_DELIM | \       | Default delimiter to be used. |

#### 6.3.6.2 Keyboard reaction

The dialog reacts to the following keys if it has the input focus:

| Key             | Reaction   |
|-----------------|--|
| GUI_KEY_TAB     | The next widget of the dialog gains the input focus.     |
| GUI_KEY_BACKTAB | The previous widget of the dialog gains the input focus. |
| GUI_KEY_ENTER   | The behavior depends on the currently focused widget.    |
| GUI_KEY_ESCAPE  | Dialog will be canceled.                                 |

#### 6.3.6.3 Path- and file names

The maximum length of path- and file names is limited to 256 bytes.



### 6.3.6.4 CHOOSEFILE API

The table below lists the available CHOOSEFILE-related routines in alphabetical order. Detailed descriptions of the routines follow.

#### Functions

| Routine  | Description   |
|--|---|
| <code>CHOOSEFILE_Create()</code>               | Creates a CHOOSEFILE dialog using the given parameters. |
| <code>CHOOSEFILE_EnableToolTips()</code>       | Enables ToolTips for CHOOSEFILE dialogs.                |
| <code>CHOOSEFILE_SetButtonText()</code>        | Uses text instead of the default image.                 |
| <code>CHOOSEFILE_SetDefaultButtonText()</code> | Sets the default text to be used for new dialogs.       |
| <code>CHOOSEFILE_SetDelim()</code>             | Sets the delimiter used within a path.                  |
| <code>CHOOSEFILE_SetToolTips()</code>          | Sets the text to be shown by the ToolTips.              |
| <code>CHOOSEFILE_SetTopMode()</code>           | Makes the button bar visible at the top of the dialog.  |

#### Data structures

| Structure                    | Description |
|------------------------------|-------------|
| <code>CHOOSEFILE_INFO</code> |             |

#### Defines

| Group of defines                       | Description                                   |
|--|---|
| <code>CHOOSEFILE_button_indexes</code> | Bitmap indexes used by the CHOOSEFILE dialog. |

### 6.3.6.4.1 Functions

#### 6.3.6.4.1.1 CHOOSEFILE\_Create()

##### Description

Creates a CHOOSEFILE dialog using the given parameters.

##### Prototype

```
WM_HWIN CHOOSEFILE_Create(    WM_HWIN    hParent,
                               int           xPos,
                               int           yPos,
                               int           xSize,
                               int           ySize,
                               const char    * apRoot[],
                               int           NumRoot,
                               int           SelRoot,
                               const char    * sCaption,
                               int           Flags,
                               CHOOSEFILE_INFO * pInfo);
```

##### Parameters

| Parameter             | Description  |
|-----------------------|--|
| <code>hParent</code>  | Handle of parent window.   |
| <code>xPos</code>     | X position in pixels of the dialog in client coordinates.                  |
| <code>yPos</code>     | Y position in pixels of the dialog in client coordinates.                  |
| <code>xSize</code>    | X-size of the dialog in pixels.  |
| <code>ySize</code>    | Y-size of the dialog in pixels.  |
| <code>apRoot</code>   | Pointer to an array of strings containing the root directories to be used. |
| <code>NumRoot</code>  | Number of root directories.  |
| <code>SelRoot</code>  | Initial index of the root directory to be used.                            |
| <code>sCaption</code> | Title to be shown in the title bar.  |
| <code>Flags</code>    | Additional flags for the FRAMEWIN widget.                                  |
| <code>pInfo</code>    | Pointer to a CHOOSEFILE_INFO structure.                                    |

##### Parameter `apRoot`

This parameter should point to an array of string pointers containing the root directories shown in the DROPDOWN widget of the dialog. The directory names do not need to have a delimiter (slash or backslash) at the end. They are copied by the function to their own locations and do not need to remain valid after creating the dialog. Empty strings are not supported and could lead to an undefined behavior of the dialog.

##### Prototype of GetData() function

```
int ( * ((CHOOSEFILE_INFO * pInfo);
```

| Parameter          | Description                             |
|--------------------|---|
| <code>pInfo</code> | Pointer to a CHOOSEFILE_INFO structure. |

##### Details about GetData() function

The `GetData()` function pointed by the element `pfGetData` has to be provided by the application. This function is responsible to pass information about the requested file to the dialog. It gets a pointer to a `CHOOSEFILE_INFO` structure which contains all details of the requested file.

The following elements are passed by the dialog to the application:

- **Cmd** Determines if information about the first or the next file should be returned.
- **pRoot** Pointer to a string containing the path of the directory to be used. The `GetData()` function then has to use the following elements for providing information about the requested file to the dialog:
- **pAttrib** Should point to a string which is shown in the 'Type' column. Because the CHOOSEFILE dialog can be used with any file system there are no special flags but a string which should be passed by the application to the dialog.
- **pName** Should point to a string which contains the file name without path and extension. Shown in the 'Name' column of the dialog.
- **pExt** Should point to a string which contains the extension of the file shown in the 'Type' column of the dialog.
- **SizeL** Should be set to the lower 32 bit of the file length.
- **SizeH** Should be set to the upper 32 bit of the file length in case of file larger than 4.294.967.295 bytes.
- **Flags** If the requested file is a directory this element has to be set to `CHOOSEFILE_FLAG_DIRECTORY`. Otherwise it has to be 0.

## Return value

Handle of the dialog on success, otherwise 0.

## Additional information

The following default values are used:

- If (`xPos < 0`) the dialog will be centered horizontally.
- If (`yPos < 0`) the dialog will be centered vertically.
- If (`xSize = 0`) the half of the display size in x will be used.
- If (`ySize = 0`) the half of the display size in y will be used.
- if (`sCaption = NULL`) 'Choose File' will be shown in the title bar.

## Example of GetData() function

The following shows an example of the `GetData()` function which can be used with WIN32. The sample folder also contains a sample which can be used with `emFile`. Here the WIN32 example:

```
static const struct {
    U32 Mask;
    char c;
} _aAttrib[] = {
    { FILE_ATTRIBUTE_READONLY , 'R' },
    { FILE_ATTRIBUTE_HIDDEN   , 'H' },
    { FILE_ATTRIBUTE_SYSTEM   , 'S' },
    { FILE_ATTRIBUTE_DIRECTORY, 'D' },
    { FILE_ATTRIBUTE_ARCHIVE  , 'A' },
    { FILE_ATTRIBUTE_NORMAL   , 'N' },
};

static int _GetData(CHOOSEFILE_INFO * pInfo) {
    static HANDLE hFind;
    static int NewDir;
    static char acDrive [_MAX_DRIVE];
    static char acDir   [_MAX_DIR];
    static char acName  [_MAX_FNAME];
    static char acExt   [_MAX_EXT];
    static char acMask  [_MAX_PATH];
    static char acPath  [_MAX_PATH];
    static char acAttrib[10] = {0};
    WIN32_FIND_DATA Context;
    int i, r;
    char c;
    switch (pInfo->Cmd) {
    case CHOOSEFILE_FINDFIRST:
        if (hFind != 0) {
```

```

    FindClose(hFind);
}
//
// Split path into drive and directory
//
_splitpath(pInfo->pRoot, acDrive, acDir, NULL, NULL);
NewDir = 1;
//
// Do not 'break' here...
//
case CHOOSEFILE_FINDNEXT:
    if (NewDir) {
        _makepath(acMask, acDrive, acDir, NULL, NULL);
        strcat(acMask, pInfo->pMask);
        hFind = FindFirstFile(acMask, &Context);
        if (hFind == INVALID_HANDLE_VALUE) {
            FindClose(hFind);
            hFind = 0;
            return 1;
        }
    } else {
        r = FindNextFile(hFind, &Context);
        if (r == 0) {
            FindClose(hFind);
            hFind = 0;
            return 1;
        }
    }
    NewDir = 0;
    //
    // Generate attribute string (pInfo->pAttrib)
    //
    for (i = 0; i < GUI_COUNTOF(_aAttrib); i++) {
        c = (Context.dwFileAttributes & _aAttrib[i].Mask) ? _aAttrib[i].c : '-';
        acAttrib[i] = c;
    }
    //
    // Make name and extension (pInfo->pName, pInfo->pExt)
    //
    if ((Context.dwFileAttributes & FILE_ATTRIBUTE_DIRECTORY) == 0) {
        _splitpath(Context.cFileName, NULL, NULL, acName, acExt);
    } else {
        strcpy(acName, Context.cFileName);
        acExt[0] = 0;
    }
    //
    // Pass data to dialog
    //
    pInfo->pAttrib = acAttrib;
    pInfo->pName = acName;
    pInfo->pExt = acExt;
    pInfo->SizeL = Context.nFileSizeLow;
    pInfo->SizeH = Context.nFileSizeHigh;
    pInfo->Flags = (Context.dwFileAttributes & FILE_ATTRIBUTE_DIRECTORY)
        ? CHOOSEFILE_FLAG_DIRECTORY : 0;
}
return 0;
}

```

### 6.3.6.4.1.2 CHOOSEFILE\_EnableToolTips()

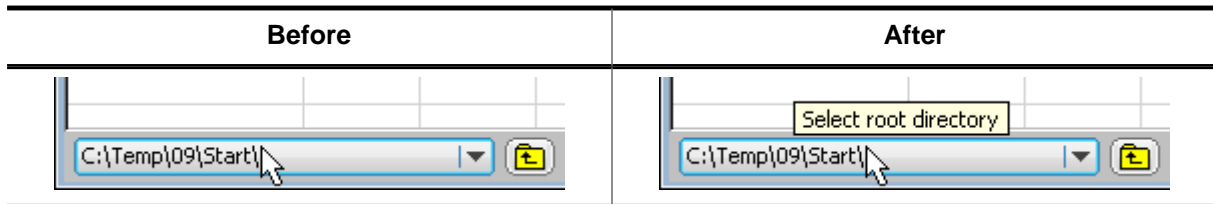

#### Description

Enables ToolTips for CHOOSEFILE dialogs.

#### Prototype

```
void CHOOSEFILE_EnableToolTips(void);
```

#### Additional information

The text of the ToolTips can be configured. Details can be found in the description of `CHOOSEFILE_SetToolTips`.

### 6.3.6.4.1.3 CHOOSEFILE\_SetButtonText()

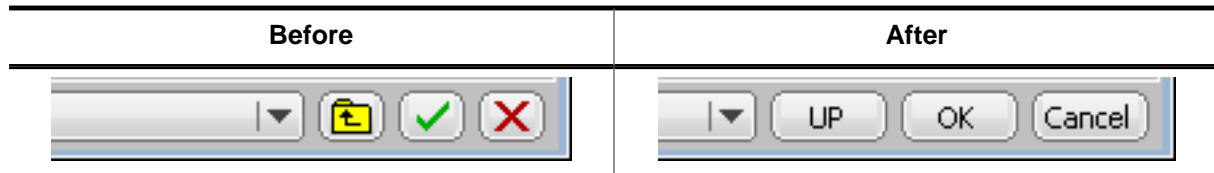

#### Description

Uses text instead of the default image.

#### Prototype

```
void CHOOSEFILE_SetButtonText(    WM_HWIN    hWin,
                                unsigned    ButtonIndex,
                                const char  * pText);
```

#### Parameters

| Parameter                | Description  |
|--------------------------|--|
| <code>hWin</code>        | Handle of the CHOOSEFILE dialog.   |
| <code>ButtonIndex</code> | See <i>CHOOSEFILE</i> button indexes on page 2505 for a full list of permitted values. |
| <code>pText</code>       | Pointer to a string to be used.  |

#### Additional information

The function copies the string(s) into its own memory location(s). The size of the buttons depend on the used text. The dialog makes sure, that all buttons which use text instead of an image have the same size.

#### 6.3.6.4.1.4 CHOOSEFILE\_SetDefaultButtonText()

##### Description

Sets the default text to be used for new dialogs.

##### Prototype

```
void CHOOSEFILE_SetDefaultButtonText(    unsigned   ButtonIndex,  
                                       const char  * pText);
```

##### Parameters

| Parameter                   | Description  |
|-----------------------------|--|
| <a href="#">ButtonIndex</a> | See <i>CHOOSEFILE</i> button indexes on page 2505 for a full list of permitted values. |
| <a href="#">pText</a>       | Text to be used per default.   |

### 6.3.6.4.1.5 CHOOSEFILE\_SetDelim()

#### Description

Sets the delimiter used within a path. Default is a backslash.

#### Prototype

```
void CHOOSEFILE_SetDelim(char Delim);
```

#### Parameters

| Parameter          | Description           |
|--------------------|-----------------------|
| <code>Delim</code> | Delimiter to be used. |



### 6.3.6.4.1.6 CHOOSEFILE\_SetToolTips()

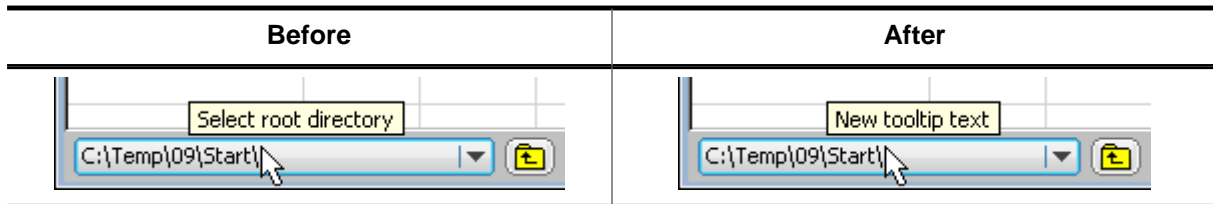

#### Description

Sets the text to be shown by the ToolTips.

#### Prototype

```
void CHOOSEFILE_SetToolTips(const TOOLTIP_INFO * pInfo,
                             int NumItems);
```

#### Parameters

| Parameter             | Description  |
|-----------------------|--|
| <code>pInfo</code>    | Pointer to an array of <code>TOOLTIP_INFO</code> structures. |
| <code>NumItems</code> | Number of items pointed by <code>pInfo</code> .              |

#### Additional information

The elements of the `TOOLTIP_INFO` structure are described in the section *ToolTips* on page 810.

### 6.3.6.4.1.7 CHOOSEFILE\_SetTopMode()

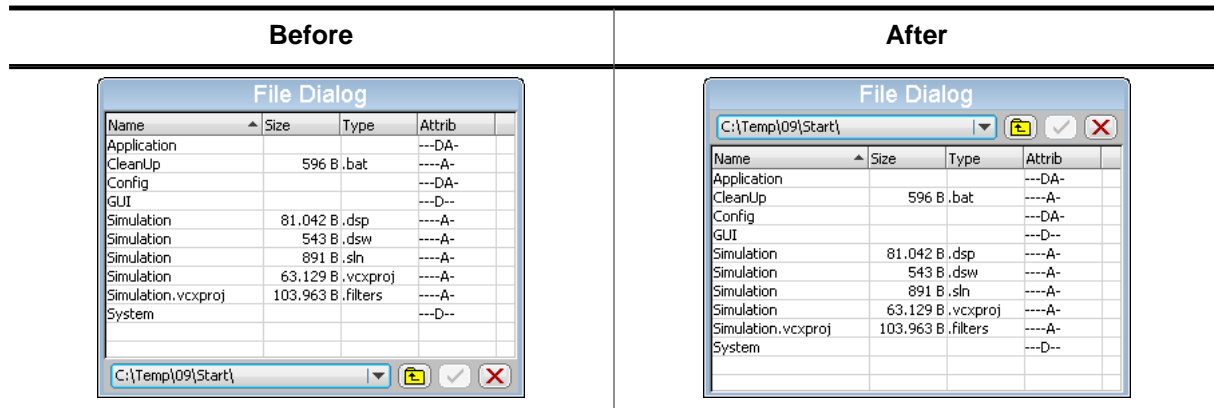

#### Description

Makes the button bar visible at the top of the dialog.

#### Prototype

```
void CHOOSEFILE_SetTopMode( unsigned OnOff );
```

#### Parameters

| Parameter          | Description                                  |
|--------------------|--|
| <code>OnOff</code> | 1 for top mode, 0 (default) for bottom mode. |

### 6.3.6.4.2 Data structures

#### 6.3.6.4.3 CHOOSEFILE\_INFO

##### Description

Structure that contains information for creating a CHOOSEFILE dialog.

##### Type definition

```
typedef struct {
    int          Cmd;
    const char   * pMask;
    char         * pName;
    char         * pExt;
    char         * pAttrib;
    U32          SizeL;
    U32          SizeH;
    U32          Flags;
    char         pRoot[CHOOSEFILE_MAXLEN];
    int          (* pfGetData)(CHOOSEFILE_INFO * pInfo);
} CHOOSEFILE_INFO;
```

##### Structure members

| Member                 | Description  |
|------------------------|--|
| <code>Cmd</code>       | Command for GetData() function. See below.   |
| <code>pMask</code>     | This parameter is passed to the GetData() function and contains a mask which can be used for filtering the search result.          |
| <code>pName</code>     | Pointer to the file name of the requested file.  |
| <code>pExt</code>      | Pointer to the extension of the requested file.  |
| <code>pAttrib</code>   | Pointer to the attribute string of the requested file.   |
| <code>SizeL</code>     | Lower 32 bit of the file size.   |
| <code>SizeH</code>     | Upper 32 bit of the file size.   |
| <code>Flags</code>     | If the requested file is a directory it should be set to <code>CHOOSEFILE_FLAG_DIRECTORY</code> , otherwise it should be set to 0. |
| <code>pRoot</code>     | Pointer to a string containing the complete path of the currently used directory.  |
| <code>pfGetData</code> | Pointer to the GetData() function to be used.  |

| Permitted values for element <code>Cmd</code> |  |
|---|--|
| <code>CHOOSEFILE_FINDFIRST</code>             | The first entry of the current directory should be returned. |
| <code>CHOOSEFILE_FINDNEXT</code>              | The next entry of the current directory should be returned.  |

##### Element CHOOSEFILE\_FINDFIRST

This command is sent to the given callback routine to get the first entry of the current directory. The element `pRoot` of the `CHOOSEFILE_INFO` structure pointed by the parameter `pInfo` of the callback function contains the path to be used.

The following elements of the `CHOOSEFILE_INFO` structure should be used by the application to return information of the requested file: `pName`, `pExt`, `pAttrib`, `SizeL`, `SizeH` and `Flags`. The parameter `pAttrib` contains a string to be shown in the 'Attrib' column. This string has to be build by the application. So each attributes independent of the used file system can be shown.

All strings used to return information about the file are copied by the dialog into its own memory locations.

If no file could be found the `GetData()` function should return 1.

### **Element CHOOSEFILE\_FINDNEXT**

This command is sent to the given callback routine to get the next entry of the chosen directory. If no further file could be found the `GetData()` function should return 1.

### 6.3.6.4.4 Defines

#### 6.3.6.4.4.1 CHOOSEFILE button indexes

##### Description

Button indexes used by the CHOOSEFILE dialog.

##### Definition

```
#define CHOOSEFILE_BI_CANCEL    0
#define CHOOSEFILE_BI_OK      1
#define CHOOSEFILE_BI_UP      2
```

##### Symbols

| Definition                           | Description               |
|--------------------------------------|---------------------------|
| <a href="#">CHOOSEFILE_BI_CANCEL</a> | Index of 'Cancel' button. |
| <a href="#">CHOOSEFILE_BI_OK</a>     | Index of 'Ok' button.     |
| <a href="#">CHOOSEFILE_BI_UP</a>     | Index of 'Up' button.     |

## 6.3.7 MESSAGEBOX dialog

A MESSAGEBOX is used to show a message in a frame window with a title bar, as well as an "OK" button which must be pressed in order to close the window. It requires only one line of code to create or to create and execute a message box.

### Note

All MESSAGEBOX-related routines are in the file(s) MESSAGEBOX\*.c, MESSAGEBOX.h and GUI.h.

### Simple message boxes



### 6.3.7.1 Configuration options

| Type | Macro              | Default   | Description   |
|------|--------------------|-----------|---|
| N    | MESSAGEBOX_BORDER  | 4         | Distance between the elements of a message box and the elements of the client window frame. |
| N    | MESSAGEBOX_XSIZEOK | 50        | X-size of the "OK" button.  |
| N    | MESSAGEBOX_YSIZEOK | 20        | Y-size of the "OK" button.  |
| S    | MESSAGEBOX_BKCOLOR | GUI_WHITE | Color of the client window background.  |

### 6.3.7.2 Keyboard reaction

The widget consists of a FRAMEWIN, a TEXT and a BUTTON widget. When executing a message box the BUTTON widget gains the input focus. Detailed information on how keyboard events are handled by the BUTTON widget can be found in the section *BUTTON: Button widget* on page 1003.

### 6.3.7.3 MESSAGEBOX API

The table below lists the available emWin MESSAGEBOX-related routines in alphabetical order. Detailed descriptions follow.

| Routine                             | Description                         |
|-------------------------------------|-------------------------------------|
| <a href="#">GUI_MessageBox()</a>    | Creates and displays a message box. |
| <a href="#">MESSAGEBOX_Create()</a> | Creates a message box.              |

### 6.3.7.3.1 GUI\_MessageBox()

#### Description

Creates and displays a message box.

#### Prototype

```
int GUI_MessageBox(const char * sMessage,
                  const char * sCaption,
                  int    Flags);
```

#### Parameters

| Parameter             | Description                                    |
|-----------------------|--|
| <code>sMessage</code> | Message to display.                            |
| <code>sCaption</code> | Caption for the title bar of the frame window. |
| <code>Flags</code>    | See table below.                               |

| Permitted values for parameter <code>Flags</code> |  |
|---|--|
| <code>GUI_MESSAGEBOX_CF_MOVEABLE</code>           | The message box can be moved by dragging the title bar or the frame. |
| <code>0</code>                                    | No function.   |

#### Additional information

This function offers the possibility to create and execute a MESSAGEBOX with one line of code. An example implementation can be found in the sample application `DIALOG_MessageBox.c` which is located in the `Sample` folder. Details about dragging can be found in the description of `FRAMEWIN_SetMoveable()`.

### 6.3.7.3.2 MESSAGEBOX\_Create()

#### Description

Creates a message box.

#### Prototype

```
WM_HWIN MESSAGEBOX_Create(const char * sMessage,
                          const char * sCaption,
                          int      Flags);
```

#### Parameters

| Parameter             | Description                                    |
|-----------------------|--|
| <code>sMessage</code> | Message to display.                            |
| <code>sCaption</code> | Caption for the title bar of the frame window. |
| <code>Flags</code>    | See table below.                               |

| Permitted values for parameter <code>Flags</code> |   |
|---|---|
| <code>GUI_MESSAGEBOX_CF_MODAL</code>              | Creates a modal message box. The default is creating a non modal message box. |

#### Return value

Handle of the message box window.

#### Additional information

The function creates a message box consisting of a frame window with the caption text in the title bar, a text widget with the message text and a button widget representing the 'OK' button. After creating the message box the dialog behavior may be changed by using a user defined callback function or the properties of the box items can be modified using the widget API functions.

The following IDs can be used for accessing the items:

| ID                        | Description  |
|---------------------------|--|
| <code>GUI_ID_TEXT0</code> | ID of the TEXT widget containing the message text. |
| <code>GUI_ID_OK</code>    | ID of the 'OK' BUTTON widget.                      |

The frame window can be accessed by the handle returned by this function. The function `GUI_ExecCreatedDialog()` should be used to execute the message box.



## 6.4 Skinning

Skinning is a method of changing the appearance of one or multiple widgets. It allows changing the look by using a dedicated skin which defines how the widgets are rendered. This makes it easy to change the appearance of a complete group of widgets in a similar way by changing only the skin.

Without skinning, widget member functions have to be used to change the look for each single widget or the callback function has to be overwritten.



### 6.4.1 What is a 'skin'

A skin is just a simple callback function which is available for drawing all details of a widget. It works by exactly same way as a 'user draw function' of a widget, an older method of widget customization which was available before skinning was implemented.

### 6.4.2 From using API functions to skinning

There are different methods to change the appearance of a widget. Widget API functions, user draw functions, skinning and overwriting the callback function can be used to modify the appearance of a widget. The decision of the method to be used depends on what should be changed. The following explains what can be achieved with each method.

#### Using widget API functions

The default API functions can be used to change attributes like size, color, font or bitmaps used to draw a widget using the classical design. The following screenshot shows a typical sample of what can be done:

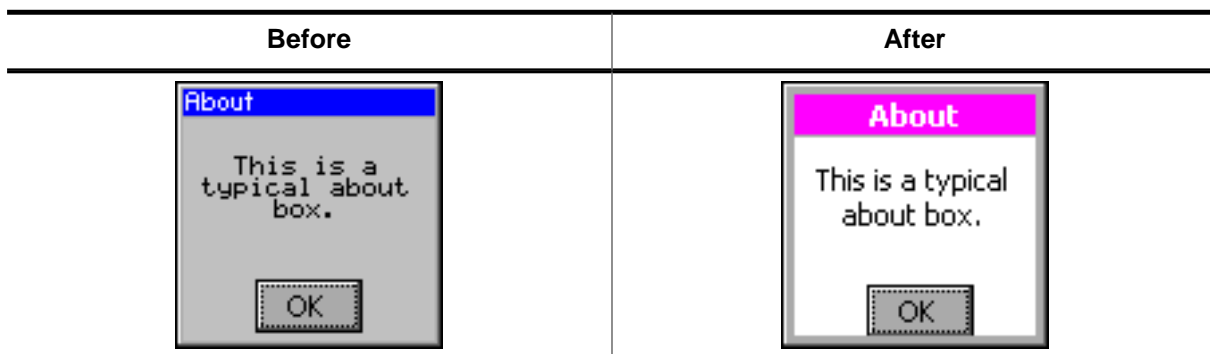

Some attributes can be changed but the basic appearance stays the same.

### User draw functions

Some widgets like LISTBOX, FRAMEWIN, GRAPH or BUTTON widgets offer user draw functions. These functions can be used to draw some additional details or to replace the default drawing method for some items. The following screenshot shows a user drawn title area of a frame window. The user draw function renders the gradient in the title area, which can't be achieved with the widget API functions:

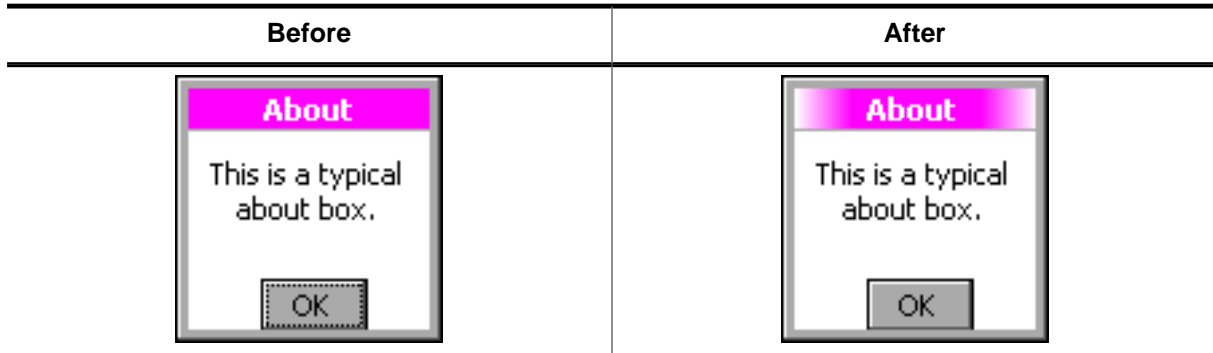

### Skinning

Contrary to the methods mentioned above skinning covers the drawing of the whole widget and not only some details. We also used this opportunity to lift the appearance of the skinnable widgets which look much more up-to-date as the classical widget design. The following table shows the look of the about box from above in comparison with the new default skin:

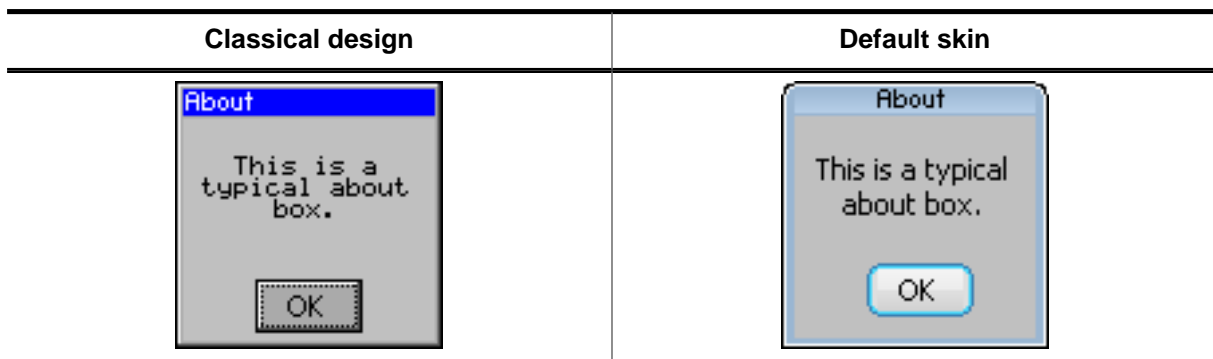

### Overwriting the callback function of a widget

Before skinning was implemented, the only method of changing the complete appearance of a widget was overwriting the callback function of a widget. This gives full control over the complete message processing of the widget. It can be used in combination with the other methods. The main disadvantage of overwriting the callback function is that lots of code needs to be written by the user. This process is prone to error.

### Using widget API for skinned widgets

Some functions do not have an effect anymore on widget properties. For example, the function `BUTTON_SetColor()` doesn't work with the Flex skin, due to the fact that the `BUTTON` doesn't consist of a single color anymore.

### 6.4.3 Skinnable widgets

Skinning only makes sense if a widget consists of several widget specific details. It does not make sense for each kind of widget. A TEXT widget for example does not require a separate skin, because it consists only of the text itself.

Currently the following widgets support skinning:

- BUTTON
- CHECKBOX
- DROPDOWN
- FRAMEWIN
- HEADER
- MENU
- MULTIPAGE
- PROGBAR
- RADIO
- SCROLLBAR
- SLIDER
- SPINBOX

### 6.4.4 Using a skin

The shipment of emWin contains a ready-to-use default skin for all above listed skinnable widgets. They have been named <WIDGET>\_SKIN\_FLEX.

The following table shows the available default skins for all skinnable widgets:

| Widget    | Default skin        |
|-----------|---------------------|
| BUTTON    | BUTTON_SKIN_FLEX    |
| CHECKBOX  | CHECKBOX_SKIN_FLEX  |
| DROPDOWN  | DROPDOWN_SKIN_FLEX  |
| FRAMEWIN  | FRAMEWIN_SKIN_FLEX  |
| HEADER    | HEADER_SKIN_FLEX    |
| MENU      | MENU_SKIN_FLEX      |
| MULTIPAGE | MULTIPAGE_SKIN_FLEX |
| PROGBAR   | PROGBAR_SKIN_FLEX   |
| RADIO     | RADIO_SKIN_FLEX     |
| SCROLLBAR | SCROLLBAR_SKIN_FLEX |
| SLIDER    | SLIDER_SKIN_FLEX    |
| SPINBOX   | SPINBOX_SKIN_FLEX   |

### 6.4.4.1 Runtime configuration

To use these skins the function `<WIDGET>_SetSkin(<WIDGET>_SKIN_FLEX)` can be used. Further it is possible to set a default skin by `<WIDGET>_SetDefaultSkin()` which is used automatically for each new widget.

#### Switching from classic design to a skin

The most recommended way of using a skin is first setup the widget behavior and then creating the widget.

#### Example

The following example shows how a skin can be used:

```
BUTTON_SetSkin(hButton, BUTTON_SKIN_FLEX); // Sets the skin for the given widget
BUTTON_SetDefaultSkin(BUTTON_SKIN_FLEX); // Sets the default skin for new widgets
```

#### Additional information

|  |  |
|--|--|
| <code>&lt;WIDGET&gt;_SetSkin()</code>        | can be called at any time causing the given widget to use the set skinning routine.    |
| <code>&lt;WIDGET&gt;_SetDefaultSkin()</code> | has to be called before creating the widget which should use the set skinning routine. |
| <code>&lt;WIDGET&gt;_SetDefaultSkin()</code> | should be used when multiple or all widgets should use the same skinning routine.      |

### 6.4.4.2 Compile-time configuration

If Skinning should be used by default the compile time configuration macro `WIDGET_USE_FLEX_SKIN` needs to be defined as 1 in `GUIConf.h`.

#### Example

To use skinning per default the macro should be added to the file `GUIConf.h`:

```
#define WIDGET_USE_FLEX_SKIN 1
```

## 6.4.5 Simple changes to the look of the 'Flex' skin

Similar to the API functions available for changing the attributes of the classical look the attributes of the 'Flex' skin can also be changed. This can be done without knowing all details of the skinning mechanism.

The function(s) `<WIDGET>_SetSkinFlexProps()` explained in detail later in this chapter can be used to change the attributes. For each skin exist functions for getting and setting the attributes.

#### Example

The following code shows how to change the attributes of the button skin:

```
BUTTON_GetSkinFlexProps(&Props, BUTTON_SKINFLEX_FOCUSED);
Props.aColorFrame[0] = 0x007FB13C;
Props.aColorFrame[1] = 0x008FfF8F;
Props.Radius = 6;
BUTTON_SetSkinFlexProps(&Props, BUTTON_SKINFLEX_FOCUSED);
WM_InvalidateWindow(hWin);
```

Since skin properties are general to a certain type of widget, setting skin properties does not invalidate any window. Widgets which are affected by any changes have to be invalidated as shown above.

**Screenshot**

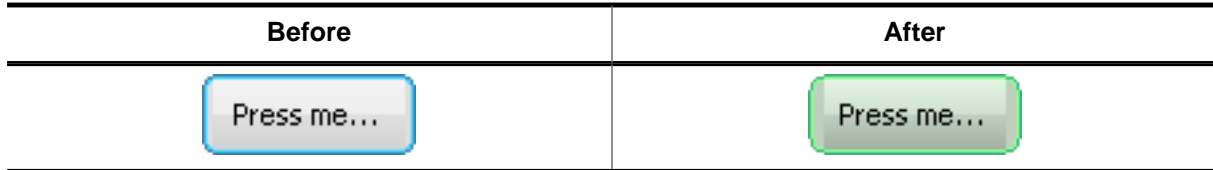

**6.4.6 Major changes to the 'Flex' skin**

The drawing mechanism of the default design without skinning is a 'black box' for the application designer. The same is true for skinning if no major changes of the default look are required. If changing the attributes of the default skin is not sufficient to realize the required look, it is required to understand the details of the drawing mechanism of skinning.

**6.4.6.1 The skinning callback mechanism**

The drawing mechanism for all skinnable widgets is very similar and looks as follows:

```
int <WIDGET>_DrawSkin(const WIDGET_ITEM_DRAW_INFO * pDrawItemInfo) {
    switch (pDrawItemInfo->Cmd) {
        case WIDGET_ITEM_DRAW_BACKGROUND:
            /* Draw the background */
            break;
        case WIDGET_ITEM_DRAW_TEXT:
            /* Draw the text */
            break;
        case WIDGET_ITEM_CREATE:
            /* Additional function calls required to create the widget */
            break;
        ...
    }
}
```

**Elements of structure WIDGET\_ITEM\_DRAW\_INFO**

| Data type | Element   | Description                                  |
|-----------|-----------|--|
| WM_HWIN   | hWin      | Handle to the widget.                        |
| int       | Cmd       | Command to be processed.                     |
| int       | ItemIndex | Index of item to be drawn.                   |
| int       | x0        | Leftmost coordinate in window coordinates.   |
| int       | y0        | Topmost coordinate in window coordinates.    |
| int       | x1        | Rightmost coordinate in window coordinates.  |
| int       | y1        | Bottommost coordinate in window coordinates. |
| void *    | p         | Data pointer to widget specific information. |

This scheme is identical to all skinnable widgets. The callback function receives a pointer to a WIDGET\_ITEM\_DRAW\_INFO structure. The structure pointed by pDrawItemInfo contains a command which has to be processed, a handle to the widget and further information whose meaning may vary by widget. The skinning callback function has to react with drawing a dedicated detail or with returning a dedicated value. How to use the drawing information in detail is explained later in this chapter.

**6.4.6.2 Changing the look of the default skin**

Understanding the above callback mechanism is important because changing a skin can easily be done by deriving a new skin from an existing one. A small example should show how the look of the default skin of a widget can be changed. Assuming the default look of the frame window skin should be changed because an icon should be shown on the left side of the title bar. The default appearance of the FRAMEWIN skin is as follows:

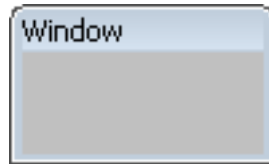

This should be changed to the following:

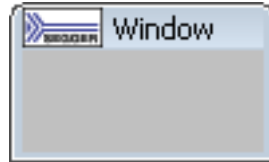

This can be done easily by using a customized skin derived from the default skin. The following code shows how this can be achieved. It shows a custom skinning callback function which is used as skin by the function `FRAMEWIN_SetSkin()`. Because the icon should be drawn in the text area of the frame window the function overwrites the default behavior of the text drawing:

```
case WIDGET_ITEM_DRAW_TEXT:
    ...
    All other tasks should be performed by the default skin:
    default:
        return FRAMEWIN_DrawSkinFlex(pDrawItemInfo);
```

## Example

```
static int _DrawSkinFlex_FRAME(const WIDGET_ITEM_DRAW_INFO * pDrawItemInfo) {
    char acBuffer[20];
    GUI_RECT Rect;
    switch (pDrawItemInfo->Cmd) {
        case WIDGET_ITEM_DRAW_TEXT:
            //
            // Draw icon at the left side
            //
            GUI_DrawBitmap(&_bmLogo_30x15, pDrawItemInfo->x0, pDrawItemInfo->y0);
            //
            // Draw text beneath
            //
            FRAMEWIN_GetText(pDrawItemInfo->hWin, acBuffer, sizeof(acBuffer));
            GUI_SetColor(GUI_BLACK);
            Rect.x0 = pDrawItemInfo->x0 // Default position of text
                + _bmLogo_30x15.XSize // + X-size of icon
                + 4; // + small gap between icon and text
            Rect.y0 = pDrawItemInfo->y0;
            Rect.x1 = pDrawItemInfo->x1;
            Rect.y1 = pDrawItemInfo->y1;
            GUI_DispStringInRect(acBuffer, &Rect, GUI_TA_VCENTER);
            break;
        default:
            //
            // Use the default skinning routine for processing all other commands
            //
            return FRAMEWIN_DrawSkinFlex(pDrawItemInfo);
    }
    return 0;
}

void _SetSkin(WM_HWIN) {
    //
    // Set the derived
    //
    FRAMEWIN_SetSkin(hFrame, _DrawSkinFlex_FRAME);
}
```

### 6.4.6.3 List of commands

The skinning routine receives a pointer to a `WIDGET_ITEM_DRAW_INFO` structure. The `Cmd` member of this structure contains the command which needs to be processed. There are several commands which are sent to the skinning routine of a widget, but only a set of commands is sent to a certain type of widget. Further the exact meaning may vary according to the widget. How to react to commands is explained in the widget specific sections of this chapter. The following table gives an overview of the commands which are sent to the skinning routines:

| Command Id (Cmd)             | Description   |
|------------------------------|---|
| Creation messages            |   |
| WIDGET_ITEM_CREATE           | Sent to each skinnable widget after it has been created but before it is drawn. |
| Information messages         |   |
| WIDGET_ITEM_GET_BORDERSIZE_B | Used to get the size of the bottom border.                                      |
| WIDGET_ITEM_GET_BORDERSIZE_L | Used to get the size of the left border.  |
| WIDGET_ITEM_GET_BORDERSIZE_R | Used to get the size of the right border.                                       |
| WIDGET_ITEM_GET_BORDERSIZE_T | Used to get the size of the top border.   |
| WIDGET_ITEM_GET_BUTTONSIZE   | Used to get the button size.  |
| WIDGET_ITEM_GET_XSIZE        | Used to get the X-size.   |
| WIDGET_ITEM_GET_YSIZE        | Used to get the Y-size.   |
| Drawing messages             |   |
| WIDGET_ITEM_DRAW_ARROW       | Used to draw an arrow.  |
| WIDGET_ITEM_DRAW_BACKGROUND  | Used to draw the background.  |
| WIDGET_ITEM_DRAW_BITMAP      | Used to draw a bitmap.  |
| WIDGET_ITEM_DRAW_BUTTON      | Used to draw the button area.   |
| WIDGET_ITEM_DRAW_BUTTON_L    | Used to draw the left button area.  |
| WIDGET_ITEM_DRAW_BUTTON_R    | Used to draw the right button area.   |
| WIDGET_ITEM_DRAW_FOCUS       | Used to draw the focus rectangle.   |
| WIDGET_ITEM_DRAW_FRAME       | Used to draw the frame of a widget.   |
| WIDGET_ITEM_DRAW_OVERLAP     | Used to draw the overlapping region.  |
| WIDGET_ITEM_DRAW_SEP         | Used to draw a separator.   |
| WIDGET_ITEM_DRAW_SHAFT       | Used to draw the shaft area.  |
| WIDGET_ITEM_DRAW_SHAFT_L     | Used to draw the left shaft area.   |
| WIDGET_ITEM_DRAW_SHAFT_R     | Used to draw the right shaft area.  |
| WIDGET_ITEM_DRAW_TEXT        | Used to draw the text.  |
| WIDGET_ITEM_DRAW_THUMB       | Used to draw the thumb area.  |
| WIDGET_ITEM_DRAW_TICKS       | Used to draw tick marks.  |

## 6.4.7 General Skinning API

The table below lists available skinning-related routines in alphabetical order. These functions are common to all skinnable widgets, and are listed here in order to avoid repetition. Detailed descriptions of the routines follow. The additional skinning member functions available for each widget may be found in later sections.

| Routine   | Description   |
|---|---|
| <code>&lt;WIDGET&gt;_DrawSkinFlex()</code>          | Skinning callback function of the default skin.       |
| <code>&lt;WIDGET&gt;_GetSkinFlexProps()</code>      | Returns the current properties of the skin.           |
| <code>&lt;WIDGET&gt;_SetDefaultSkin()</code>        | Sets the default skin used for new widgets.           |
| <code>&lt;WIDGET&gt;_SetDefaultSkinClassic()</code> | Sets the classical design as default for new widgets. |
| <code>&lt;WIDGET&gt;_SetSkin()</code>               | Sets a skin for the given widget.                     |
| <code>&lt;WIDGET&gt;_SetSkinClassic()</code>        | Sets the classical design for the given widget.       |
| <code>&lt;WIDGET&gt;_SetSkinFlexProps()</code>      | Sets the properties of the skin.                      |



### 6.4.7.1 <WIDGET>\_DrawSkinFlex()

#### Description

These functions are the skinning callback functions of the default skin and are responsible to draw the complete widget.

#### Prototype

```
int <WIDGET>_DrawSkinFlex(const WIDGET_ITEM_DRAW_INFO * pDrawItemInfo);
```

#### Parameters

| Parameter                  | Description  |
|----------------------------|--|
| <code>pDrawItemInfo</code> | Pointer to a data structure of type <code>WIDGET_ITEM_DRAW_INFO</code> . |

#### Additional information

A derived skin can use this function for drawing details of the default skin.

### 6.4.7.2 <WIDGET>\_GetSkinFlexProps()

#### Description

These functions return the attributes of the default skin. The widget specific descriptions later in this chapter explain the skin attributes in detail.

#### Prototype

```
void <WIDGET>_GetSkinFlexProps(<WIDGET>_SKINFLEX_PROPS * pProps,  
                             int Index);
```

#### Parameters

| Parameter           | Description   |
|---------------------|---|
| <code>pProps</code> | Pointer to a skin specific configuration structure of type <code>&lt;WIDGET&gt;_SKINFLEX_PROPS</code> to be filled by the function. |
| <code>Index</code>  | Widget state (pressed, active, selected, ...) for which the details should be retrieved.  |

### 6.4.7.3 <WIDGET>\_SetDefaultSkin()

#### Description

These functions set the default skin which is used for new widgets of the dedicated type.

#### Prototype

```
void <WIDGET>_SetDefaultSkin(WIDGET_DRAW_ITEM_FUNC * pfDrawSkin);
```

#### Parameters

| Parameter               | Description  |
|-------------------------|--|
| <code>pfDrawSkin</code> | Pointer to a skinning callback function of type <code>WIDGET_DRAW_ITEM_FUNC</code> . |

#### Additional information

The given pointer should point to the skinning callback routine to be used for all new widgets. Details can be found in the description of `<WIDGET>_SetSkin()` on page 2521.

#### 6.4.7.4 <WIDGET>\_SetDefaultSkinClassic()

##### Description

These functions set the classical design for all new widgets of the dedicated type.

##### Prototype

```
void <WIDGET>_SetDefaultSkinClassic(void);
```

##### Additional information

The behavior of widgets which use the classical design is completely identical to the behavior before implementing the skinning feature.

### 6.4.7.5 <WIDGET>\_SetSkin()

#### Description

These functions can be used for setting a skin for the given widget.

#### Prototype

```
void <WIDGET>_SetSkin(<WIDGET>_Handle      hObj,  
                    WIDGET_DRAW_ITEM_FUNC * pfDrawSkin);
```

#### Parameters

| Parameter               | Description  |
|-------------------------|--|
| <code>hObj</code>       | Handle to the dedicated widget.  |
| <code>pfDrawSkin</code> | Pointer to a skinning callback function of type <code>WIDGET_DRAW_ITEM_FUNC</code> . |

#### WIDGET\_DRAW\_ITEM\_FUNC

```
typedef int WIDGET_DRAW_ITEM_FUNC(const WIDGET_ITEM_DRAW_INFO * pDrawItemInfo);
```

#### Additional information

Default widget API functions may have no effect in case a skin is used.

### 6.4.7.6 <WIDGET>\_SetSkinClassic()

#### Description

These functions switch to the classical design without skinning for the given widget.

#### Prototype

```
void <WIDGET>_SetSkinClassic(<WIDGET>_Handle hObj);
```

#### Parameters

| Parameter            | Description                     |
|----------------------|---------------------------------|
| <a href="#">hObj</a> | Handle to the dedicated widget. |

#### Additional information

Additional information can be found in the description of `<WIDGET>_SetDefaultSkinClassic()` on page 2520.

### 6.4.7.7 <WIDGET>\_SetSkinFlexProps()

#### Description

With these functions some attributes of the default skin can be changed without deriving an own skin. The widget specific descriptions later in this chapter will explain in detail what can be changed.

#### Prototype

```
void <WIDGET>_SetSkinFlexProps(const <WIDGET>_SKINFLEX_PROPS * pProps,  
                               int Index);
```

#### Parameters

| Parameter           | Description  |
|---------------------|--|
| <code>pProps</code> | Pointer to a skin specific configuration structure of type <WIDGET>_SKINFLEX_PROPS.          |
| <code>Index</code>  | Details of the state (pressed, active, selected, ...) for which the details should be valid. |

### 6.4.8 BUTTON\_SKIN\_FLEX

The following picture shows the details of the skin:



The BUTTON skin consists of a rounded border and a rectangular inner area which is filled by 2 gradients. The surrounding border is drawn by 2 colors.

| Detail | Description   |
|--------|---|
| A      | Top color of top gradient.  |
| B      | Bottom color of top gradient.                                       |
| C      | Top color of bottom gradient.                                       |
| D      | Bottom color of bottom gradient.                                    |
| E      | Outer color of surrounding frame.                                   |
| F      | Inner color of surrounding frame.                                   |
| G      | Color of area between surrounding frame and inner rectangular area. |
| R      | Radius of rounded corner.   |
| T      | Optional text.  |

#### 6.4.8.1 Configuration structure

To set up the default appearance of the skin or to change it at run time configuration structures of type `BUTTON_SKINFLEX_PROPS` are used:

##### Elements of structure `BUTTON_SKINFLEX_PROPS`

| Data type | Element                     | Description   |
|-----------|-----------------------------|---|
| U32       | <code>aColorFrame[3]</code> | [0] - Outer color of surrounding frame.<br>[1] - Inner color of surrounding frame.<br>[2] - Color of area between frame and inner area. |
| U32       | <code>aColorUpper[2]</code> | [0] - First (upper) color of upper gradient.<br>[1] - Second (lower) color of upper gradient.   |
| U32       | <code>aColorLower[2]</code> | [0] - First (upper) color of lower gradient.<br>[1] - Second (lower) color of lower gradient.   |
| int       | <code>Radius</code>         | Radius of rounded corner.   |



### 6.4.8.2 Configuration options

The default appearance of the skin can be defined using custom configuration structures of the type `BUTTON_SKINFLEX_PROPS` in `GUIConf.h`. The following table shows the identifiers which are used for the different states of the skinned `BUTTON` widget:

| Macro                                  | Description   |
|--|---|
| <code>BUTTON_SKINPROPS_PRESSED</code>  | Defines the default attributes used for pressed state.  |
| <code>BUTTON_SKINPROPS_FOCUSED</code>  | Defines the default attributes used for focused state.  |
| <code>BUTTON_SKINPROPS_ENABLED</code>  | Defines the default attributes used for enabled state.  |
| <code>BUTTON_SKINPROPS_DISABLED</code> | Defines the default attributes used for disabled state. |

### 6.4.8.3 Skinning API

The table below lists the available routines in alphabetical order:

| Routine                                     | Description   |
|---|---|
| <code>BUTTON_DrawSkinFlex()</code>          | Skinning callback function of <code>BUTTON_SKIN_FLEX</code> . (Explained at the beginning of the chapter) |
| <code>BUTTON_GetSkinFlexProps()</code>      | Returns the properties of the given button skin. (Explained at the beginning of the chapter)              |
| <code>BUTTON_SetDefaultSkin()</code>        | Sets the default skin used for new button widgets. (Explained at the beginning of the chapter)            |
| <code>BUTTON_SetDefaultSkinClassic()</code> | Sets the classical design as default for new button widgets. (Explained at the beginning of the chapter)  |
| <code>BUTTON_SetSkin()</code>               | Sets a skin for the given button widget. (Explained at the beginning of the chapter)                      |
| <code>BUTTON_SetSkinClassic()</code>        | Sets the classical design for the given button widget. (Explained at the beginning of the chapter)        |
| <code>BUTTON_SetSkinFlexProps()</code>      | Sets the properties of the given button skin.   |

### 6.4.8.3.1 BUTTON\_SetSkinFlexProps()

| Before  | After  |
|---|--|
|  |  |

#### Description

Sets the properties of the given button skin.

#### Prototype

```
void BUTTON_SetSkinFlexProps(const BUTTON_SKINFLEX_PROPS * pProps,
                             int Index);
```

#### Parameters

| Parameter              | Description   |
|------------------------|---|
| <a href="#">pProps</a> | Pointer to a structure of type <code>BUTTON_SKINFLEX_PROPS</code> . |
| <a href="#">Index</a>  | See table below.  |

| Permitted values for parameter <a href="#">Index</a> |                                |
|--|--------------------------------|
| <code>BUTTON_SKINFLEX_PI_PRESSED</code>              | Properties for pressed state.  |
| <code>BUTTON_SKINFLEX_PI_FOCUSED</code>              | Properties for focused state.  |
| <code>BUTTON_SKINFLEX_PI_ENABLED</code>              | Properties for enabled state.  |
| <code>BUTTON_SKINFLEX_PI_DISABLED</code>             | Properties for disabled state. |

#### Additional information

The function passes a pointer to a `BUTTON_SKINFLEX_PROPS` structure. It can be used to set up the colors and the radius of the skin.

### 6.4.8.4 List of commands

The skinning routine receives a pointer to a `WIDGET_ITEM_DRAW_INFO` structure. The `Cmd` member of this structure contains the command which needs to be processed. The following table shows all commands passed to the `BUTTON_SKIN_FLEX` callback function:

| Command                                  | Description   |
|--|---|
| <code>WIDGET_ITEM_CREATE</code>          | Is sent immediately after creating the widget.                |
| <code>WIDGET_ITEM_DRAW_BACKGROUND</code> | The skinning function should draw the background.             |
| <code>WIDGET_ITEM_DRAW_BITMAP</code>     | The skinning function should draw the optional button bitmap. |
| <code>WIDGET_ITEM_DRAW_TEXT</code>       | The skinning function should draw the optional button text.   |

The `WIDGET_ITEM_DRAW_INFO` structure is explained at the beginning of the chapter.

#### 6.4.8.4.1 WIDGET\_ITEM\_CREATE

The skinning routine should, if necessary, set up skin related properties like e.g. transparency or text alignment.

#### 6.4.8.4.2 WIDGET\_ITEM\_DRAW\_BACKGROUND

The background of the widget should be drawn.

#### Elements of structure `WIDGET_ITEM_DRAW_INFO`

| Data type            | Element                | Description  |
|----------------------|------------------------|--|
| <code>WM_HWIN</code> | <code>hWin</code>      | Handle to the widget.                                  |
| <code>int</code>     | <code>ItemIndex</code> | See table below.                                       |
| <code>int</code>     | <code>x0</code>        | Leftmost coordinate in window coordinates, normally 0. |
| <code>int</code>     | <code>y0</code>        | Topmost coordinate in window coordinates, normally 0.  |
| <code>int</code>     | <code>x1</code>        | Rightmost coordinate in window coordinates.            |
| <code>int</code>     | <code>y1</code>        | Bottommost coordinate in window coordinates.           |

| Permitted values for element <code>ItemIndex</code> |  |
|---|--|
| <code>BUTTON_SKINFLEX_PI_PRESSED</code>             | The widget is pressed.                 |
| <code>BUTTON_SKINFLEX_PI_FOCUSED</code>             | The widget is not pressed but focused. |
| <code>BUTTON_SKINFLEX_PI_ENABLED</code>             | The widget is not focused but enabled. |
| <code>BUTTON_SKINFLEX_PI_DISABLED</code>            | The widget is disabled.                |

#### 6.4.8.4.3 WIDGET\_ITEM\_DRAW\_BITMAP

The optional button bitmap should be drawn.

#### WIDGET\_ITEM\_DRAW\_INFO

A detailed description of the elements can be found under `WIDGET_ITEM_DRAW_BACKGROUND` on page 2527.

#### Additional information

The function `BUTTON_GetBitmap()` can be used to get the optional button bitmap.

#### 6.4.8.4.4 WIDGET\_ITEM\_DRAW\_TEXT

The optional button text should be drawn.

#### WIDGET\_ITEM\_DRAW\_INFO

A detailed description of the elements can be found under *WIDGET\_ITEM\_DRAW\_BACKGROUND* on page 2527.

#### Additional information

The function `BUTTON_GetText()` can be used to get the optional text.

### 6.4.9 CHECKBOX\_SKIN\_FLEX

The following picture shows the details of the skin:

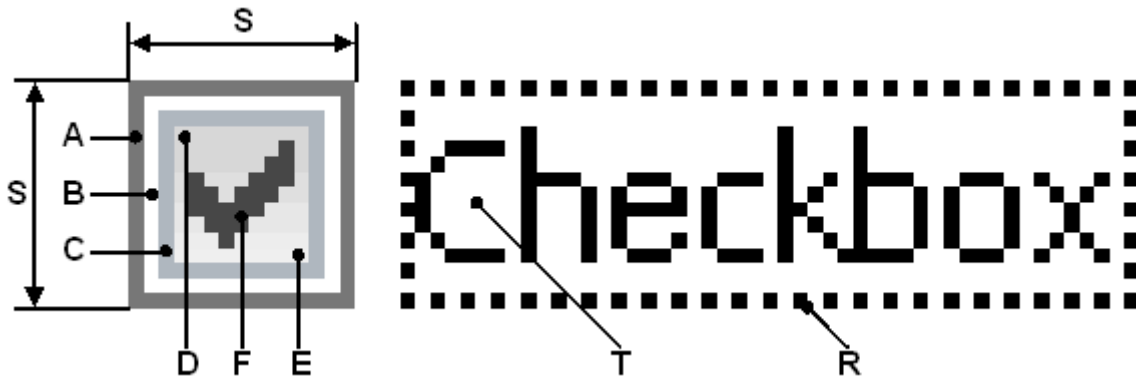

The button area of the CHECKBOX skin consists of a frame and a rectangular inner area which is filled by a gradient. The frame is drawn by 3 colors. If it is checked, a checkmark is shown in the center of the box:

| Detail | Description                    |
|--------|--------------------------------|
| A      | First color of frame.          |
| B      | Second color of frame.         |
| C      | Third color of frame.          |
| D      | Upper color of gradient.       |
| E      | Lower color of gradient.       |
| F      | Color of checkmark.            |
| R      | Focus rectangle.               |
| S      | Size in pixels of button area. |
| T      | Optional text.                 |

#### 6.4.9.1 Configuration structure

To set up the default appearance of the skin or to change it at run time configuration structures of type CHECKBOX\_SKINFLEX\_PROPS are used:

##### Elements of structure CHECKBOX\_SKINFLEX\_PROPS

| Data type | Element        | Description  |
|-----------|----------------|--|
| U32       | aColorFrame[3] | [0] - Outer color of frame.<br>[1] - Middle color of frame.<br>[2] - Inner color of frame.   |
| U32       | aColorInner[2] | [0] - First (upper) color of gradient.<br>[1] - Second (lower) color of gradient.  |
| U32       | ColorCheck     | Color of checkmark.  |
| int       | ButtonSize     | Size in pixels of the button area. (Obsolete. Use the functions CHECKBOX_GetSkinFlexButtonSize() and CHECKBOX_SetSkinFlexButtonSize()) |

### 6.4.9.2 Configuration options

The default appearance of the skin can be determined by setting custom configuration structures of the above type in `GUIConf.h`. The following table shows the available configuration options:

| Macro                                    | Description   |
|--|---|
| <code>CHECKBOX_SKINPROPS_ENABLED</code>  | Defines the default attributes used for enabled state.  |
| <code>CHECKBOX_SKINPROPS_DISABLED</code> | Defines the default attributes used for disabled state. |

### 6.4.9.3 Skinning API

The table below lists the available routines in alphabetical order:

| Routine                                       | Description   |
|---|---|
| <code>CHECKBOX_DrawSkinFlex()</code>          | Skinning callback function of <code>CHECKBOX_SKIN_FLEX</code> . (Explained at the beginning of the chapter) |
| <code>CHECKBOX_GetSkinFlexButtonSize()</code> | Returns the button size of the specified <code>CHECKBOX</code> widget.                                      |
| <code>CHECKBOX_GetSkinFlexProps()</code>      | Returns the properties of the given checkbox skin. (Explained at the beginning of the chapter)              |
| <code>CHECKBOX_SetDefaultSkin()</code>        | Sets the default skin used for new checkbox widgets. (Explained at the beginning of the chapter)            |
| <code>CHECKBOX_SetDefaultSkinClassic()</code> | Sets the classical design as default for new checkbox widgets. (Explained at the beginning of the chapter)  |
| <code>CHECKBOX_SetSkin()</code>               | Sets a skin for the given checkbox widget. (Explained at the beginning of the chapter)                      |
| <code>CHECKBOX_SetSkinClassic()</code>        | Sets the classical design for the given checkbox widget. (Explained at the beginning of the chapter)        |
| <code>CHECKBOX_SetSkinFlexButtonSize()</code> | Sets the button size of the specified <code>CHECKBOX</code> widget.   |
| <code>CHECKBOX_SetSkinFlexProps()</code>      | The function can be used to change the properties of the skin.  |

### 6.4.9.3.1 CHECKBOX\_GetSkinFlexButtonSize()

#### Description

Returns the button size of the specified CHECKBOX widget.

#### Prototype

```
int CHECKBOX_GetSkinFlexButtonSize(CHECKBOX_Handle hObj);
```



#### Parameters

| Parameter            | Description                  |
|----------------------|------------------------------|
| <a href="#">hObj</a> | Handle to a CHECKBOX widget. |

#### Return value

Button size.

### 6.4.9.3.2 CHECKBOX\_SetSkinFlexButtonSize()

| Before  | After   |
|---|---|
|  |  |

#### Description

Sets the button size of the specified CHECKBOX widget.

#### Prototype

```
void CHECKBOX_SetSkinFlexButtonSize(CHECKBOX_Handle hObj,
                                     int ButtonSize);
```

#### Parameters

| Parameter               | Description                  |
|-------------------------|------------------------------|
| <code>hObj</code>       | Handle to a CHECKBOX widget. |
| <code>ButtonSize</code> | Size to be set.              |



### 6.4.9.3.3 CHECKBOX\_SetSkinFlexProps()

| Before  | After   |
|---|---|
|  Check |  Check |

#### Description

The function can be used to change the properties of the skin.

#### Prototype

```
void CHECKBOX_SetSkinFlexProps(const CHECKBOX_SKINFLEX_PROPS * pProps,
                               int Index);
```

#### Parameters

| Parameter           | Description   |
|---------------------|---|
| <code>pProps</code> | Pointer to a structure of type <code>CHECKBOX_SKINFLEX_PROPS</code> . |
| <code>Index</code>  | See table below.  |

| Permitted values for parameter <code>Index</code> |                                |
|---|--------------------------------|
| <code>CHECKBOX_SKINFLEX_PI_ENABLED</code>         | Properties for enabled state.  |
| <code>CHECKBOX_SKINFLEX_PI_DISABLED</code>        | Properties for disabled state. |

#### Additional information

The function passes a pointer to a `CHECKBOX_SKINFLEX_PROPS` structure. It can be used to set up the colors of the skin. Please note that the size of the widgets using the skin won't be changed if for example the new button size is different to the old button size. This can not be done by the skin, because it does not 'know' which widget is using it. If required resizing should be done by the application, for example with `WM_ResizeWindow()`. The function `CHECKBOX_GetSkinFlexProps()` can be used to get the current attributes of the skin.

### 6.4.9.4 List of commands

The skinning routine receives a pointer to a `WIDGET_ITEM_DRAW_INFO` structure. The `Cmd` member of this structure contains the command which needs to be processed. The following table shows all commands passed to the `CHECKBOX_SKIN_FLEX` callback function:

| Command                              | Description  |
|--------------------------------------|--|
| <code>WIDGET_ITEM_CREATE</code>      | Is sent immediately after creating the widget.     |
| <code>WIDGET_ITEM_DRAW_BUTTON</code> | The background of the button area should be drawn. |
| <code>WIDGET_ITEM_DRAW_BITMAP</code> | The checkmark of the button area should be drawn.  |
| <code>WIDGET_ITEM_DRAW_FOCUS</code>  | The focus rectangle should be drawn.               |
| <code>WIDGET_ITEM_DRAW_TEXT</code>   | The optional text should be drawn.                 |

#### 6.4.9.4.1 WIDGET\_ITEM\_CREATE

The skinning routine should, if necessary, set up skin related properties like e.g. transparency or text alignment.

#### 6.4.9.4.2 WIDGET\_ITEM\_DRAW\_BUTTON

The button area of the widget without checkmark should be drawn. It is typically drawn at the left side of the widget area.

#### Elements of structure `WIDGET_ITEM_DRAW_INFO`

| Data type            | Element           | Description   |
|----------------------|-------------------|---|
| <code>WM_HWIN</code> | <code>hWin</code> | Handle to the widget.   |
| <code>int</code>     | <code>x0</code>   | Leftmost coordinate of widget area in window coordinates, normally 0. |
| <code>int</code>     | <code>y0</code>   | Topmost coordinate of widget area in window coordinates, normally 0.  |
| <code>int</code>     | <code>x1</code>   | Rightmost coordinate of widget area in window coordinates.            |
| <code>int</code>     | <code>y1</code>   | Bottommost coordinate of widget area in window coordinates.           |

The content of `hWin`, `x0`, `y0`, `x1` and `y1` is the same for all commands of this skin.

#### 6.4.9.4.3 WIDGET\_ITEM\_DRAW\_BITMAP

The checkmark should be drawn in the center of the button area.

#### Elements of structure `WIDGET_ITEM_DRAW_INFO`

| Element                           | Description   |
|-----------------------------------|---|
| <code>ItemIndex</code>            | 1 - The widget is checked.<br>2 - Second checked state when using a 3 state button.   |
| <code>hWin, x0, y0, x1, y1</code> | These elements are described under <code>WIDGET_ITEM_DRAW_BUTTON</code> on page 2534. |

#### 6.4.9.4.4 WIDGET\_ITEM\_DRAW\_FOCUS

The focus rectangle should be drawn around the text.

##### Elements of structure WIDGET\_ITEM\_DRAW\_INFO

| Element              | Description   |
|----------------------|---|
| p                    | The void pointer points to the zero terminated optional text of the widget.     |
| hWin, x0, y0, x1, y1 | These elements are described under <i>WIDGET_ITEM_DRAW_BUTTON</i> on page 2534. |

##### Additional information

The element p can be casted to a text pointer. Details can be found in the description of *WIDGET\_ITEM\_DRAW\_TEXT* on page 2528.

#### 6.4.9.4.5 WIDGET\_ITEM\_DRAW\_TEXT

The optional text should be drawn. The text is typically drawn at the right side of the button area.

##### Elements of structure WIDGET\_ITEM\_DRAW\_INFO

| Element              | Description   |
|----------------------|---|
| p                    | The void pointer points to the zero terminated optional text of the widget.     |
| hWin, x0, y0, x1, y1 | These elements are described under <i>WIDGET_ITEM_DRAW_BUTTON</i> on page 2534. |

##### Additional information

To get a text pointer the element p can be casted to a text pointer:

```
char * s;
s = (char *)pDrawItemInfo->p;
GUI_DispString(s);
```

### 6.4.10 DROPDOWN\_SKIN\_FLEX

The following picture shows the details of the skin:

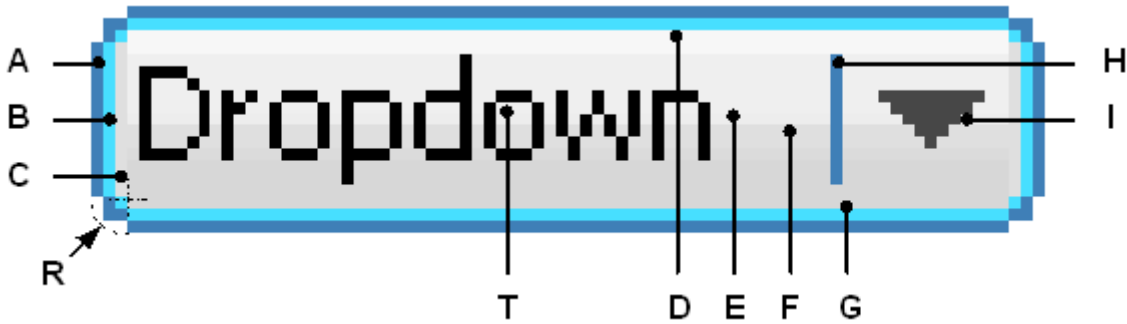

The DROPDOWN skin consists of a rounded frame and a rectangular inner area which is filled by two gradients. The rounded frame is drawn by 3 colors. At the right side a small triangle is drawn. Between text and triangle a small separator is drawn:

| Detail | Description                          |
|--------|--------------------------------------|
| A      | First color of frame.                |
| B      | Second color of frame.               |
| C      | Third color of frame.                |
| D      | Top color of top gradient.           |
| E      | Bottom color of top gradient.        |
| F      | Top color of bottom gradient.        |
| G      | Bottom color of bottom gradient.     |
| H      | Separator between text and triangle. |
| I      | Triangle.                            |
| R      | Radius of rounded corner.            |
| T      | Optional text.                       |

The dropdown widget in open state consists of an additional LISTBOX widget. The skin does not affect the LISTBOX.

#### 6.4.10.1 Configuration structure

To set up the default appearance of the skin or to change it at run time configuration structures of type `DROPDOWN_SKINFLEX_PROPS` are used:

##### Elements of structure `DROPDOWN_SKINFLEX_PROPS`

| Data type | Element        | Description   |
|-----------|----------------|---|
| U32       | aColorFrame[3] | [0] - Outer color of surrounding frame.<br>[1] - Inner color of surrounding frame.<br>[2] - Color of area between frame and inner area. |
| U32       | aColorUpper[2] | [0] - Top color of top gradient.<br>[1] - Bottom color of top gradient.   |
| U32       | aColorLower[2] | [0] - Top color of bottom gradient.<br>[1] - Bottom color of bottom gradient.   |
| U32       | ColorArrow     | Color used to draw the arrow.   |
| U32       | ColorText      | Color used to draw the text.  |
| U32       | ColorSep       | Color used to draw the separator.   |
| int       | Radius         | Radius of rounded corner.   |

## 6.4.10.2 Configuration options

The default appearance of the skin can be determined by setting custom configuration structures of the above type in `GUIConf.h`. The following table shows the available configuration options:

| Macro                                    | Description   |
|--|---|
| <code>DROPDOWN_SKINPROPS_OPEN</code>     | Defines the default attributes used for open state.     |
| <code>DROPDOWN_SKINPROPS_FOCUSED</code>  | Defines the default attributes used for focused state.  |
| <code>DROPDOWN_SKINPROPS_ENABLED</code>  | Defines the default attributes used for enabled state.  |
| <code>DROPDOWN_SKINPROPS_DISABLED</code> | Defines the default attributes used for disabled state. |

## 6.4.10.3 Skinning API

The table below lists the available routines in alphabetical order:

| Routine                                       | Description   |
|---|---|
| <code>DROPDOWN_DrawSkinFlex()</code>          | Skinning callback function of <code>DROPDOWN_SKIN_FLEX</code> . (Explained at the beginning of the chapter) |
| <code>DROPDOWN_GetSkinFlexProps()</code>      | Returns the properties of the given dropdown skin. (Explained at the beginning of the chapter)              |
| <code>DROPDOWN_SetDefaultSkin()</code>        | Sets the default skin used for new dropdown widgets. (Explained at the beginning of the chapter)            |
| <code>DROPDOWN_SetDefaultSkinClassic()</code> | Sets the classical design as default for new dropdown widgets. (Explained at the beginning of the chapter)  |
| <code>DROPDOWN_SetSkin()</code>               | Sets a skin for the given dropdown widget. (Explained at the beginning of the chapter)                      |
| <code>DROPDOWN_SetSkinClassic()</code>        | Sets the classical design for the given dropdown widget. (Explained at the beginning of the chapter)        |
| <code>DROPDOWN_SetSkinFlexProps()</code>      | The function can be used to change the properties of the skin.  |

### 6.4.10.3.1 DROPDOWN\_SetSkinFlexProps()



#### Description

The function can be used to change the properties of the skin.

#### Prototype

```
void DROPDOWN_SetSkinFlexProps(const DROPDOWN_SKINFLEX_PROPS * pProps,
                               int Index);
```

#### Parameters

| Parameter           | Description   |
|---------------------|---|
| <code>pProps</code> | Pointer to a structure of type <code>DROPDOWN_SKINFLEX_PROPS</code> . |
| <code>Index</code>  | See table below.  |

| Permitted values for parameter <code>Index</code> |                                |
|---|--------------------------------|
| <code>DROPDOWN_SKINFLEX_PI_OPEN</code>            | Properties for open state.     |
| <code>DROPDOWN_SKINFLEX_PI_FOCUSED</code>         | Properties for focused state.  |
| <code>DROPDOWN_SKINFLEX_PI_ENABLED</code>         | Properties for enabled state.  |
| <code>DROPDOWN_SKINFLEX_PI_DISABLED</code>        | Properties for disabled state. |

#### Additional information

The function passes a pointer to a `DROPDOWN_SKINFLEX_PROPS` structure. It can be used to set up the colors and the radius of the skin. The function `DROPDOWN_GetSkinFlexProps()` can be used to get the current attributes of the skin.

## 6.4.10.4 List of commands

The skinning routine receives a pointer to a `WIDGET_ITEM_DRAW_INFO` structure. The `Cmd` member of this structure contains the command which needs to be processed. The following table shows all commands passed to the `DROPDOWN_SKIN_FLEX` callback function:

| Command                                  | Description   |
|--|---|
| <code>WIDGET_ITEM_CREATE</code>          | Is sent immediately after creating the widget.              |
| <code>WIDGET_ITEM_DRAW_ARROW</code>      | The skinning function should draw the arrow.                |
| <code>WIDGET_ITEM_DRAW_BACKGROUND</code> | The skinning function should draw the background.           |
| <code>WIDGET_ITEM_DRAW_TEXT</code>       | The skinning function should draw the optional button text. |

### 6.4.10.4.1 WIDGET\_ITEM\_CREATE

The skinning routine should, if necessary, set up skin related properties like e.g. transparency or text alignment.

### 6.4.10.4.2 WIDGET\_ITEM\_DRAW\_ARROW

The triangle (arrow) at the right side should be drawn.

#### Elements of structure `WIDGET_ITEM_DRAW_INFO`

A detailed description of the elements can be found under `WIDGET_ITEM_DRAW_BACKGROUND` on page 2527.

### 6.4.10.4.3 WIDGET\_ITEM\_DRAW\_BACKGROUND

The background of the widget should be drawn.

#### Elements of structure `WIDGET_ITEM_DRAW_INFO`

| Data type            | Element                | Description  |
|----------------------|------------------------|--|
| <code>WM_HWIN</code> | <code>hWin</code>      | Handle to the widget.                                  |
| <code>int</code>     | <code>ItemIndex</code> | See table below.                                       |
| <code>int</code>     | <code>x0</code>        | Leftmost coordinate in window coordinates, normally 0. |
| <code>int</code>     | <code>y0</code>        | Topmost coordinate in window coordinates, normally 0.  |
| <code>int</code>     | <code>x1</code>        | Rightmost coordinate in window coordinates.            |
| <code>int</code>     | <code>y1</code>        | Bottommost coordinate in window coordinates.           |

#### Permitted values for element `ItemIndex`

|  |   |
|--|---|
| <code>DROPDOWN_SKINFLEX_PI_EXPANDED</code> | The widget is expanded.                   |
| <code>DROPDOWN_SKINFLEX_PI_FOCUSED</code>  | The widget is in not pressed but focused. |
| <code>DROPDOWN_SKINFLEX_PI_ENABLED</code>  | The widget is in not focused but enabled. |
| <code>DROPDOWN_SKINFLEX_PI_DISABLED</code> | The widget is disabled.                   |

### 6.4.10.4.4 WIDGET\_ITEM\_DRAW\_TEXT

The text of the currently selected string should be drawn within the button area of the dropdown widget. The text is typically drawn at the left side of the button area.

#### Elements of structure `WIDGET_ITEM_DRAW_INFO`

A detailed description of the elements can be found under `WIDGET_ITEM_DRAW_BACKGROUND` on page 2527.

## 6.4.11 FRAMEWIN\_SKIN\_FLEX

The following picture shows the details of the skin:

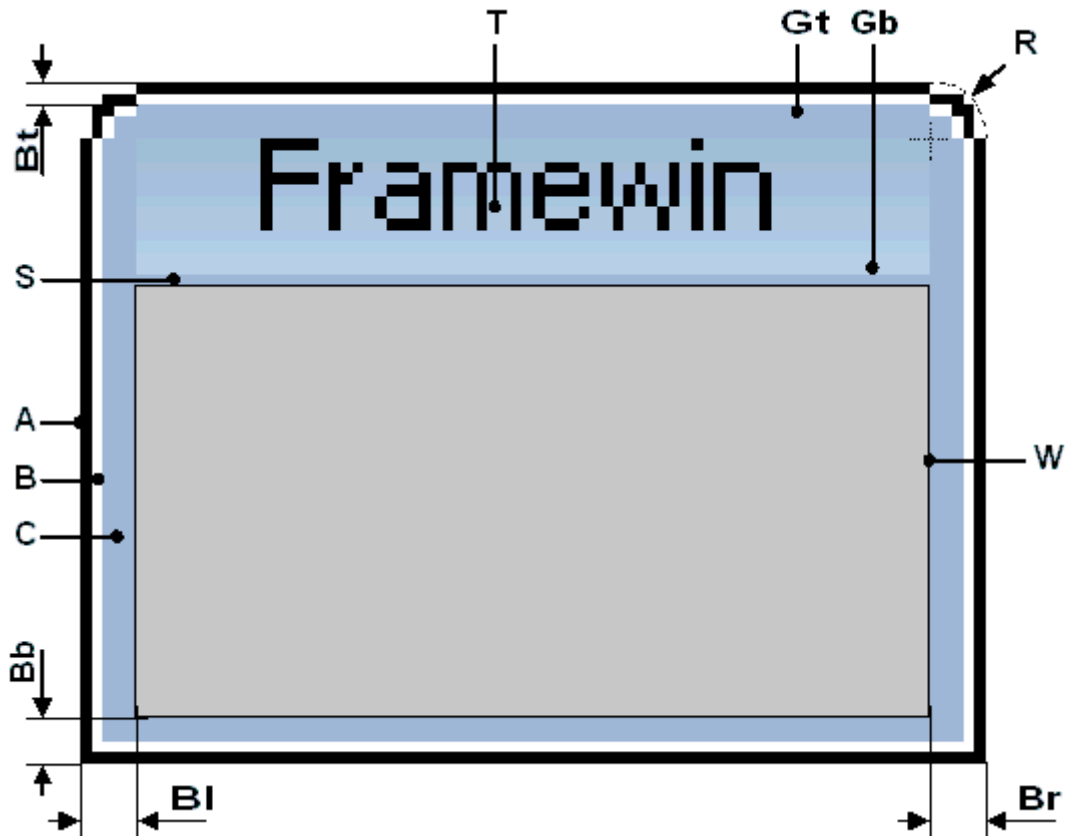

The FRAMEWIN skin consists of a title bar, rounded corners at the top, a gradient used to draw the background of the title bar, a border whose size is configurable and a separator between title bar and client area:

| Detail | Description                                 |
|--------|---|
| A      | Outer color of surrounding frame.           |
| B      | Inner color of surrounding frame.           |
| C      | Color of area between frame and inner area. |
| Gt     | Top color of top title bar gradient.        |
| Gb     | Bottom color of title bar gradient.         |
| Bt     | Top size of border.                         |
| Bb     | Bottom size of border.                      |
| Bl     | Left size of border.                        |
| Br     | Right size of border.                       |
| W      | Area of client window.                      |
| R      | Radius of rounded corner.                   |
| T      | Optional text.                              |

### 6.4.11.1 Configuration structure

To set up the default appearance of the skin or to change it at run time configuration structures of type `FRAMEWIN_SKINFLEX_PROPS` are used:



## Elements of structure FRAMEWIN\_SKINFLEX\_PROPS

| Data type | Element        | Description   |
|-----------|----------------|---|
| U32       | aColorFrame[3] | [0] - Outer color of surrounding frame.<br>[1] - Inner color of surrounding frame.<br>[2] - Color of area between frame and inner area. |
| U32       | aColorTitle[2] | [0] - Top color of top title bar gradient.<br>[1] - Bottom color of title bar gradient.   |
| int       | Radius         | Radius of rounded corners.  |
| int       | SpaceX         | Optional space in X between title text and border of title gradient.  |
| int       | BorderSizeL    | Left size of border.  |
| int       | BorderSizeR    | Right size of border.   |
| int       | BorderSizeT    | Top size of border.   |
| int       | BorderSizeB    | Bottom size of border.  |

### 6.4.11.2 Configuration options

The default appearance of the skin can be determined by setting custom configuration structures of the above type in `GUIConf.h`. The following table shows the available configuration options:

| Macro                       | Description   |
|-----------------------------|---|
| FRAMEWIN_SKINPROPS_ACTIVE   | Defines the default attributes used for active state.   |
| FRAMEWIN_SKINPROPS_INACTIVE | Defines the default attributes used for inactive state. |

### 6.4.11.3 Skinning API

The table below lists the available routines in alphabetical order:

| Routine                                       | Description   |
|---|---|
| <code>FRAMEWIN_DrawSkinFlex()</code>          | Skinning callback function of <code>FRAMEWIN_SKIN_FLEX</code> . (Explained at the beginning of the chapter) |
| <code>FRAMEWIN_GetSkinFlexProps()</code>      | Returns the properties of the given <code>FRAMEWIN</code> skin. (Explained at the beginning of the chapter) |
| <code>FRAMEWIN_SetDefaultSkin()</code>        | Sets the default skin used for new framewin widgets. (Explained at the beginning of the chapter)            |
| <code>FRAMEWIN_SetDefaultSkinClassic()</code> | Sets the classical design as default for new framewin widgets. (Explained at the beginning of the chapter)  |
| <code>FRAMEWIN_SetSkin()</code>               | Sets a skin for the given framewin widget. (Explained at the beginning of the chapter)                      |
| <code>FRAMEWIN_SetSkinClassic()</code>        | Sets the classical design for the given framewin widget. (Explained at the beginning of the chapter)        |
| <code>FRAMEWIN_SetSkinFlexProps()</code>      | The function can be used to change the properties of the skin.  |

### 6.4.11.3.1 FRAMEWIN\_SetSkinFlexProps()



#### Description

The function can be used to change the properties of the skin.

#### Prototype

```
void FRAMEWIN_SetSkinFlexProps(const FRAMEWIN_SKINFLEX_PROPS * pProps,
                               int Index);
```

#### Parameters

| Parameter           | Description   |
|---------------------|---|
| <code>pProps</code> | Pointer to a structure of type <code>FRAMEWIN_SKINFLEX_PROPS</code> . |
| <code>Index</code>  | See table below.  |

| Permitted values for parameter <code>Index</code> |                                |
|---|--------------------------------|
| <code>FRAMEWIN_SKINFLEX_PI_ACTIVE</code>          | Properties for active state.   |
| <code>FRAMEWIN_SKINFLEX_PI_INACTIVE</code>        | Properties for inactive state. |

#### Additional information

The function passes a pointer to a `FRAMEWIN_SKINFLEX_PROPS` structure. It can be used to set up the colors, radius and border size of the skin. The function `FRAMEWIN_GetSkinFlexProps()` can be used to get the current attributes of the skin. When creating a frame window using this skin the values for inactive state are used for calculating size and position of the client window.

### 6.4.11.4 List of commands

The skinning routine receives a pointer to a `WIDGET_ITEM_DRAW_INFO` structure. The `Cmd` member of this structure contains the command which needs to be processed. The following table shows all commands passed to the `FRAMEWIN_SKIN_FLEX` callback function:

| Command                                   | Description  |
|---|--|
| <code>WIDGET_ITEM_CREATE</code>           | Is sent immediately after creating the widget.                 |
| <code>WIDGET_ITEM_DRAW_BACKGROUND</code>  | The skinning function should draw the title background.        |
| <code>WIDGET_ITEM_DRAW_FRAME</code>       | The skinning function should draw the frame.                   |
| <code>WIDGET_ITEM_DRAW_SEP</code>         | The skinning function should draw the separator.               |
| <code>WIDGET_ITEM_DRAW_TEXT</code>        | The skinning function should draw the title text.              |
| <code>WIDGET_ITEM_GET_BORDERSIZE_L</code> | The skinning function should return the left border size.      |
| <code>WIDGET_ITEM_GET_BORDERSIZE_R</code> | The skinning function should return the right border size.     |
| <code>WIDGET_ITEM_GET_BORDERSIZE_T</code> | The skinning function should return the top border size.       |
| <code>WIDGET_ITEM_GET_BORDERSIZE_B</code> | The skinning function should return the bottom border size.    |
| <code>WIDGET_ITEM_GET_RADIUS</code>       | The skinning function should return the radius of the corners. |

#### 6.4.11.4.1 WIDGET\_ITEM\_CREATE

The skinning routine should, if necessary, set up skin related properties like e.g. transparency or text alignment.

#### 6.4.11.4.2 WIDGET\_ITEM\_DRAW\_BACKGROUND

The skinning routine should draw the background of the title area.

#### Elements of structure `WIDGET_ITEM_DRAW_INFO`

| Data type            | Element                | Description  |
|----------------------|------------------------|--|
| <code>WM_HWIN</code> | <code>hWin</code>      | Handle to the widget.                                      |
| <code>int</code>     | <code>ItemIndex</code> | See table below.   |
| <code>int</code>     | <code>x0</code>        | Leftmost coordinate of title area in window coordinates.   |
| <code>int</code>     | <code>y0</code>        | Topmost coordinate of title area in window coordinates.    |
| <code>int</code>     | <code>x1</code>        | Rightmost coordinate of title area in window coordinates.  |
| <code>int</code>     | <code>y1</code>        | Bottommost coordinate of title area in window coordinates. |

Permitted values for element `ItemIndex`

|  |                                  |
|--|----------------------------------|
| <code>FRAMEWIN_SKINFLEX_PI_ACTIVE</code>   | The widget is in active state.   |
| <code>FRAMEWIN_SKINFLEX_PI_INACTIVE</code> | The widget is in inactive state. |

### 6.4.11.4.3 WIDGET\_ITEM\_DRAW\_FRAME

The skinning routine should draw the complete border without the title area and the separator.

#### Elements of structure WIDGET\_ITEM\_DRAW\_INFO

| Data type | Element   | Description  |
|-----------|-----------|--|
| WM_HWIN   | hWin      | Handle to the widget.  |
| int       | ItemIndex | See table below.   |
| int       | x0        | Leftmost coordinate in window coordinates, normally 0.             |
| int       | y0        | Topmost coordinate in window coordinates, normally 0.              |
| int       | x1        | Rightmost coordinate in window coordinates (xSize of window - 1).  |
| int       | y1        | Bottommost coordinate in window coordinates (ySize of window - 1). |

#### Permitted values for element ItemIndex

|                               |                                  |
|-------------------------------|----------------------------------|
| FRAMEWIN_SKINFLEX_PI_ACTIVE   | The widget is in active state.   |
| FRAMEWIN_SKINFLEX_PI_INACTIVE | The widget is in inactive state. |

### 6.4.11.4.4 WIDGET\_ITEM\_DRAW\_TEXT

The skinning routine should draw title text.

#### Elements of structure WIDGET\_ITEM\_DRAW\_INFO

A detailed description of the elements can be found under *WIDGET\_ITEM\_DRAW\_BACKGROUND* on page 2527.

### 6.4.11.4.5 WIDGET\_ITEM\_GET\_BORDERSIZE\_L

### 6.4.11.4.6 WIDGET\_ITEM\_GET\_BORDERSIZE\_R

### 6.4.11.4.7 WIDGET\_ITEM\_GET\_BORDERSIZE\_T

### 6.4.11.4.8 WIDGET\_ITEM\_GET\_BORDERSIZE\_B

The skinning routine should return the size of the according border.

## 6.4.12 HEADER\_SKIN\_FLEX

The following picture shows the details of the skin:

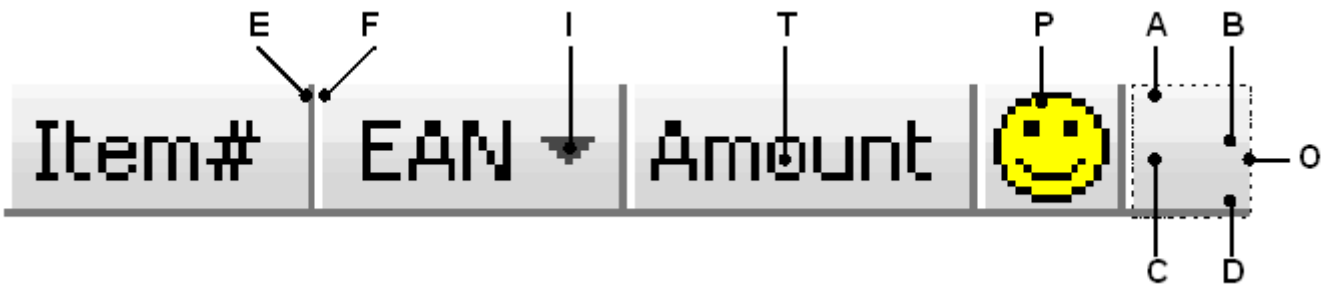

The HEADER skin consists of a bar with a thin border which is divided into separate items. The background of the bar consists of a top and a bottom gradient. Each item can have a text, a bitmap and an indicator which can be used for example to show the sorting order:

| Detail | Description                      |
|--------|----------------------------------|
| A      | Top color of top gradient.       |
| B      | Bottom color of top gradient.    |
| C      | Top color of bottom gradient.    |
| D      | Bottom color of bottom gradient. |
| E      | First color of frame.            |
| F      | Second color of frame.           |
| I      | Indicator.                       |
| T      | Text (optional).                 |
| P      | Bitmap (optional).               |

### 6.4.12.1 Configuration structure

To set up the default appearance of the skin or to change it at run time configuration structures of type `HEADER_SKINFLEX_PROPS` are used:

#### Elements of structure `HEADER_SKINFLEX_PROPS`

| Data type | Element                     | Description   |
|-----------|-----------------------------|---|
| U32       | <code>aColorFrame[2]</code> | [0] - First color of frame and separators.<br>[1] - Second color of frame and separators. |
| U32       | <code>aColorUpper[2]</code> | [0] - Top color of top gradient.<br>[1] - Bottom color of top gradient.                   |
| U32       | <code>aColorLower[2]</code> | [0] - Top color of bottom gradient.<br>[1] - Bottom color of bottom gradient.             |
| U32       | <code>ColorArrow</code>     | Color of indicator.   |

### 6.4.12.2 Configuration options

The default appearance of the skin can be determined by setting custom configuration structures of the above type in `GUIConf.h`. The following table shows the available configuration options:



| Macro                         | Description   |
|-------------------------------|---|
| <code>HEADER_SKINPROPS</code> | Defines the default attributes used for drawing the skin. |

### 6.4.12.3 Skinning API

The table below lists the available routines in alphabetical order:

| Routine                                     | Description   |
|---|---|
| <code>HEADER_DrawSkinFlex()</code>          | Skinning callback function of <code>HEADER_SKIN_FLEX</code> . (Explained at the beginning of the chapter)             |
| <code>HEADER_GetSkinFlexProps()</code>      | Returns the properties of the given <code>HEADER</code> skin. (Explained at the beginning of the chapter)             |
| <code>HEADER_SetDefaultSkin()</code>        | Sets the default skin used for new <code>HEADER</code> widgets. (Explained at the beginning of the chapter)           |
| <code>HEADER_SetDefaultSkinClassic()</code> | Sets the classical design as default for new <code>HEADER</code> widgets. (Explained at the beginning of the chapter) |
| <code>HEADER_SetSkin()</code>               | Sets a skin for the given <code>HEADER</code> widget. (Explained at the beginning of the chapter)                     |
| <code>HEADER_SetSkinClassic()</code>        | Sets the classical design for the given <code>HEADER</code> widget. (Explained at the beginning of the chapter)       |
| <code>HEADER_SetSkinFlexProps()</code>      | The function can be used to change the properties of the skin.  |

### 6.4.12.3.1 HEADER\_SetSkinFlexProps()

| Before  | After  |
|---|--|
|  |  |

#### Description

The function can be used to change the properties of the skin.

#### Prototype

```
void HEADER_SetSkinFlexProps(const HEADER_SKINFLEX_PROPS * pProps,
                             int Index);
```

#### Parameters

| Parameter           | Description   |
|---------------------|---|
| <code>pProps</code> | Pointer to a structure of type <code>HEADER_SKINFLEX_PROPS</code> . |
| <code>Index</code>  | See table below.  |

#### Additional information

The function passes a pointer to a `HEADER_SKINFLEX_PROPS` structure. It can be used to set up the colors of the skin. The function `HEADER_GetSkinFlexProps()` can be used to get the current attributes of the skin.

### 6.4.12.4 List of commands

The skinning routine receives a pointer to a `WIDGET_ITEM_DRAW_INFO` structure. The `Cmd` member of this structure contains the command which needs to be processed. The following table shows all commands passed to the `HEADER_SKIN_FLEX` callback function:

| Command                                  | Description   |
|--|---|
| <code>WIDGET_ITEM_CREATE</code>          | Is sent immediately after creating the widget.          |
| <code>WIDGET_ITEM_DRAW_ARROW</code>      | The indicator arrow of the header item should be drawn. |
| <code>WIDGET_ITEM_DRAW_BACKGROUND</code> | The background of the header item should be drawn.      |
| <code>WIDGET_ITEM_DRAW_BITMAP</code>     | The bitmap of the header item should be drawn.          |
| <code>WIDGET_ITEM_DRAW_OVERLAP</code>    | The overlapping region of the widget should be drawn.   |
| <code>WIDGET_ITEM_DRAW_TEXT</code>       | The text of the header item should be drawn.            |

#### 6.4.12.4.1 WIDGET\_ITEM\_CREATE

The skinning routine should, if necessary, set up skin related properties like e.g. transparency or text alignment.

#### 6.4.12.4.2 WIDGET\_ITEM\_DRAW\_ARROW

The skinning routine should draw the optional direction indicator. This message is sent only if the indicator of the header item is enabled.

#### Elements of structure `WIDGET_ITEM_DRAW_INFO`

A detailed description of the elements can be found under `WIDGET_ITEM_DRAW_BACKGROUND` on page 2527.

#### 6.4.12.4.3 WIDGET\_ITEM\_DRAW\_BACKGROUND

The skinning routine should draw the background of an item area.

#### Elements of structure `WIDGET_ITEM_DRAW_INFO`

| Data type            | Element                | Description   |
|----------------------|------------------------|---|
| <code>WM_HWIN</code> | <code>hWin</code>      | Handle to the widget.                                     |
| <code>int</code>     | <code>ItemIndex</code> | Is always 0.  |
| <code>int</code>     | <code>x0</code>        | Leftmost coordinate of item area in window coordinates.   |
| <code>int</code>     | <code>y0</code>        | Topmost coordinate of item area in window coordinates.    |
| <code>int</code>     | <code>x1</code>        | Rightmost coordinate of item area in window coordinates.  |
| <code>int</code>     | <code>y1</code>        | Bottommost coordinate of item area in window coordinates. |

#### 6.4.12.4.4 WIDGET\_ITEM\_DRAW\_BITMAP

The skinning routine should draw the optional item bitmap. The message is only sent in case of an existing bitmap.

#### Elements of structure `WIDGET_ITEM_DRAW_INFO`

A detailed description of the elements can be found under `WIDGET_ITEM_DRAW_BACKGROUND` on page 2527.



#### 6.4.12.4.5 WIDGET\_ITEM\_DRAW\_OVERLAP

The skinning routine should draw the overlapping region.

##### Elements of structure WIDGET\_ITEM\_DRAW\_INFO

A detailed description of the elements can be found under *WIDGET\_ITEM\_DRAW\_BACKGROUND* on page 2527.

#### 6.4.12.4.6 Widget\_ITEM\_DRAW\_TEXT

The skinning routine should draw the optional item text. The message is only sent in case of an existing text.

##### Elements of structure WIDGET\_ITEM\_DRAW\_INFO

A detailed description of the elements can be found under *WIDGET\_ITEM\_DRAW\_BACKGROUND* on page 2527.

### 6.4.13 MENU\_SKIN\_FLEX

The following picture shows the details of the skin:

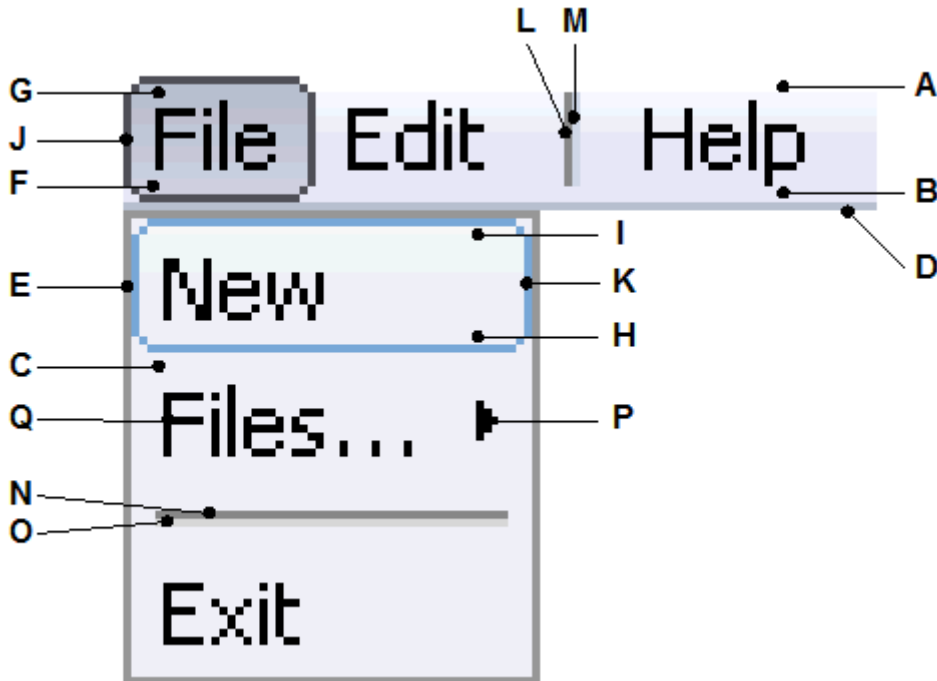

The MENU skin covers horizontal as well as vertical MENU widgets. Since both variations require the ability to be handled differently, most items can be colored separately. The background is drawn by a gradient for horizontal MENU widgets. The vertical version only consists of a single background color. Selected and selected items having a submenu are drawn using a gradient and a frame. All vertical items are surrounded by a frame. Horizontal items are just underlined. Vertical items with a submenu consist of an arrow indicating the submenu. Separators are drawn using 2 lines with 2 different colors. The item text is displayed using the same color for all items.

| Detail | Description  |
|--------|--|
| A      | Top color of the background gradient. (horizontal)                       |
| B      | Bottom color of the background gradient. (horizontal)                    |
| C      | Background color. (vertical)   |
| D      | Frame color. (horizontal)  |
| E      | Frame color. (vertical)  |
| F      | Bottom color of the background gradient for selected items. (horizontal) |
| G      | Top color of the background gradient for selected items. (horizontal)    |
| H      | Bottom color of the background gradient for selected items. (vertical)   |
| I      | Top color of the background gradient for selected items. (vertical)      |
| J      | Frame color for selected items. (horizontal)                             |
| K      | Frame color for selected items. (vertical)                               |
| L      | Left separator color. (horizontal)                                       |
| M      | Right separator color. (horizontal)                                      |
| N      | Top separator color. (vertical)  |
| O      | Bottom separator color. (vertical)                                       |
| P      | Color of the arrow indicating submenus.                                  |
| Q      | Color of the text.   |

### 6.4.13.1 Configuration structure

To set up the default appearance of the skin or to change it at run time configuration a structure of the type `MENU_SKINFLEX_PROPS` must be used:

#### Elements of structure `MENU_SKINFLEX_PROPS`

| Data type  | Element                     | Description  |
|------------|-----------------------------|--|
| Background |                             |  |
| U32        | <code>aBkColorH[2]</code>   | Horizontal:<br>[0] - Top color of background gradient.<br>[1] - Bottom color of horizontal background gradient.                                    |
| U32        | <code>BkColorV</code>       | Background color. (vertical)   |
| U32        | <code>FrameColorH</code>    | Frame color. (horizontal)  |
| U32        | <code>FrameColorV</code>    | Frame color. (vertical)  |
| Selection  |                             |  |
| U32        | <code>aSelColorH[2]</code>  | Horizontal:<br>[0] - Top color of the background gradient for selected items.<br>[1] - Bottom color of the background gradient for selected items. |
| U32        | <code>aSelColorV[2]</code>  | Vertical:<br>[0] - Top color of the background gradient for selected items.<br>[1] - Bottom color of the background gradient for selected items.   |
| U32        | <code>FrameColorSelH</code> | Frame color for selected items. (horizontal)   |
| U32        | <code>FrameColorSelV</code> | Frame color for selected items. (vertical)   |
| Separator  |                             |  |
| U32        | <code>aSepColorH[2]</code>  | Horizontal:<br>[0] - Left separator color.<br>[1] - Right separator color.   |
| U32        | <code>aSepColorV[2]</code>  | Vertical:<br>[0] - Top separator color.<br>[1] - Bottom separator color.   |
| General    |                             |  |
| U32        | <code>ArrowColor</code>     | Color of the arrow indicating submenus.  |
| U32        | <code>TextColor</code>      | Color of the text.   |

### 6.4.13.2 Configuration options

The default appearance of the skin can be determined by setting custom configuration structures of the above type in `GUIConf.h`. The following table shows the available configuration options:

| Macro                                      | Description  |
|--|--|
| <code>MENU_SKINPROPS_ACTIVE_SUBMENU</code> | Defines the default attributes which are used to draw the item in case its submenu is active.            |
| <code>MENU_SKINPROPS_DISABLED</code>       | Defines the default attributes which are used to draw the item in disabled state.                        |
| <code>MENU_SKINPROPS_DISABLED_SEL</code>   | Defines the default attributes which are used to draw the item in case it is selected in disabled state. |
| <code>MENU_SKINPROPS_ENABLED</code>        | Defines the default attributes which are used to draw the item in enabled state.                         |
| <code>MENU_SKINPROPS_SELECTED</code>       | Defines the default attributes which are used to draw the item in selected state.                        |

### 6.4.13.3 Skinning API

The table below lists the available routines in alphabetical order:

| Routine                                   | Description   |
|---|---|
| <code>MENU_DrawSkinFlex()</code>          | Skinning callback function of <code>MENU_SKIN_FLEX</code> . (Explained at the beginning of the chapter)             |
| <code>MENU_GetSkinFlexProps()</code>      | Returns the properties of the given <code>MENU</code> skin. (Explained at the beginning of the chapter)             |
| <code>MENU_SetDefaultSkin()</code>        | Sets the default skin used for new <code>MENU</code> widgets. (Explained at the beginning of the chapter)           |
| <code>MENU_SetDefaultSkinClassic()</code> | Sets the classical design as default for new <code>MENU</code> widgets. (Explained at the beginning of the chapter) |
| <code>MENU_SetSkin()</code>               | Sets a skin for the given <code>MENU</code> widget. (Explained at the beginning of the chapter)                     |
| <code>MENU_SetSkinClassic()</code>        | Sets the classical design for the given <code>MENU</code> widget. (Explained at the beginning of the chapter)       |
| <code>MENU_SetSkinFlexProps()</code>      | The function can be used to change the colors of the skin.  |
| <code>MENU_SkinEnableArrow()</code>       | Toggles the drawing of an arrow.  |

### 6.4.13.3.1 MENU\_SetSkinFlexProps()

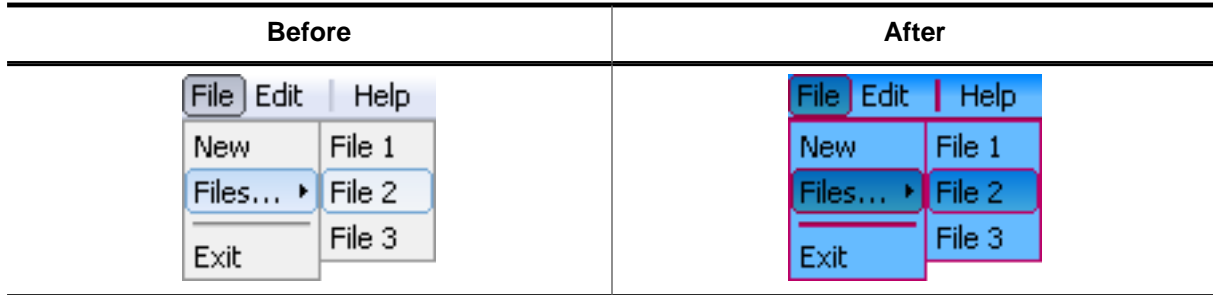

#### Description

The function can be used to change the colors of the skin.

#### Prototype

```
void MENU_SetSkinFlexProps(const MENU_SKINFLEX_PROPS * pProps,
                          int Index);
```

#### Parameters

| Parameter           | Description   |
|---------------------|---|
| <code>pProps</code> | Pointer to a structure of type <code>MENU_SKINFLEX_PROPS</code> . |
| <code>Index</code>  | See table below.  |

| Permitted values for parameter <code>Index</code> |   |
|---|---|
| <code>MENU_SKINFLEX_PI_ENABLED</code>             | Properties for enabled state.           |
| <code>MENU_SKINFLEX_PI_SELECTED</code>            | Properties for selected state.          |
| <code>MENU_SKINFLEX_PI_DISABLED</code>            | Properties for disabled state.          |
| <code>MENU_SKINFLEX_PI_DISABLED_SEL</code>        | Properties for disabled selected state. |
| <code>MENU_SKINFLEX_PI_ACTIVE_SUBMENU</code>      | Properties for active submenu state.    |

#### Additional information

The function passes a pointer to a `MENU_SKINFLEX_PROPS` structure. It can be used to set up the colors of the skin. The function `MENU_GetSkinFlexProps()` can be used to get the current attributes of the skin.

### 6.4.13.3.2 MENU\_SkinEnableArrow()

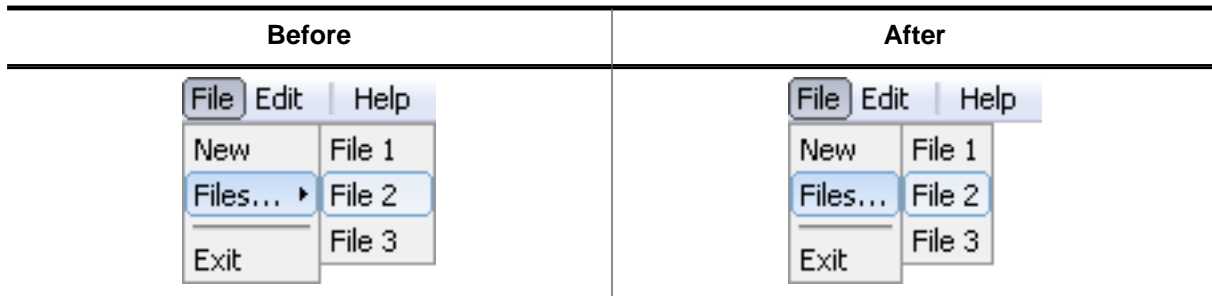

#### Description

Toggles the drawing of an arrow.

#### Prototype

```
void MENU_SkinEnableArrow(MENU_Handle hObj,
                          int         OnOff);
```

#### Parameters

| Parameter          | Description  |
|--------------------|--|
| <code>hObj</code>  | Handle the MENU widget.  |
| <code>OnOff</code> | 1 to enable drawing of arrows. 0 to disable drawing of arrows. |

#### Additional information

Arrows are drawn only...

- ...if the item is part of a vertical MENU widget.
- ...if the item consists of a submenu.
- ...if drawing of arrows is enabled using this function.

### 6.4.13.4 List of commands

The skinning routine receives a pointer to a `WIDGET_ITEM_DRAW_INFO` structure. The `Cmd` member of this structure contains the command which needs to be processed. The following table shows all commands passed to the `MENU_SKIN_FLEX` callback function:

| Command                                  | Description                                       |
|--|---|
| <code>WIDGET_ITEM_CREATE</code>          | Is sent immediately after creating the widget.    |
| <code>WIDGET_ITEM_DRAW_ARROW</code>      | The skinning function should draw the arrow.      |
| <code>WIDGET_ITEM_DRAW_BACKGROUND</code> | The skinning function should draw the background. |
| <code>WIDGET_ITEM_DRAW_FRAME</code>      | The skinning function should draw the frame.      |
| <code>WIDGET_ITEM_DRAW_SEP</code>        | The skinning function should draw the separator.  |
| <code>WIDGET_ITEM_DRAW_TEXT</code>       | The skinning function should draw the text.       |

#### 6.4.13.4.1 WIDGET\_ITEM\_CREATE

The skinning routine should, if necessary, set up skin related properties like e.g. transparency or text alignment.

#### 6.4.13.4.2 WIDGET\_ITEM\_DRAW\_ARROW

The skinning routine should draw the arrow.

#### Elements of structure `WIDGET_ITEM_DRAW_INFO`

| Data type            | Element                | Description   |
|----------------------|------------------------|---|
| <code>WM_HWIN</code> | <code>hWin</code>      | Handle to the widget.   |
| <code>int</code>     | <code>ItemIndex</code> | Index of the according item ( $\geq 0$ ).                     |
| <code>int</code>     | <code>x0</code>        | Leftmost coordinate of the item area in window coordinates.   |
| <code>int</code>     | <code>y0</code>        | Topmost coordinate of the item area in window coordinates.    |
| <code>int</code>     | <code>x1</code>        | Rightmost coordinate of the item area in window coordinates.  |
| <code>int</code>     | <code>y1</code>        | Bottommost coordinate of the item area in window coordinates. |

#### Additional information

This message is sent only in case drawing arrows is enabled. Drawing is enabled by default when using `MENU_SKIN_FLEX`. Detailed information on how to enable/disable drawing of arrows can be found in the description of the function `MENU_SkinEnableArrow` on page 2554.

#### Additional information

This message is sent only in case drawing arrows is enabled. Drawing is enabled by default when using `MENU_SKIN_FLEX`. Detailed information on how to enable/disable drawing of arrows can be found in the description of the function `MENU_SkinEnableArrow` on page 2554.

### 6.4.13.4.3 WIDGET\_ITEM\_DRAW\_BACKGROUND

The skinning routine should draw the background.

#### Elements of structure WIDGET\_ITEM\_DRAW\_INFO

| Data type | Element   | Description   |
|-----------|-----------|---|
| WM_HWIN   | hWin      | Handle to the widget.   |
| int       | ItemIndex | Index of the according item ( $\geq 0$ ) or -1.               |
| int       | x0        | Leftmost coordinate of the item area in window coordinates.   |
| int       | y0        | Topmost coordinate of the item area in window coordinates.    |
| int       | x1        | Rightmost coordinate of the item area in window coordinates.  |
| int       | y1        | Bottommost coordinate of the item area in window coordinates. |

#### Additional information

This message is sent once per each item of the MENU widget. In case a horizontal MENU widget is not completely covered by items, `WIDGET_ITEM_DRAW_BACKGROUND` is sent one more time with `ItemIndex = -1` and the coordinates of the unused area right of the last item.

### 6.4.13.4.4 WIDGET\_ITEM\_DRAW\_FRAME

The skinning routine should draw the surrounding frame.

#### Elements of structure WIDGET\_ITEM\_DRAW\_INFO

See `WIDGET_ITEM_DRAW_ARROW` on page 2539.

### 6.4.13.4.5 WIDGET\_ITEM\_DRAW\_TEXT

The skinning routine should draw the text.

#### Elements of structure WIDGET\_ITEM\_DRAW\_INFO

See `WIDGET_ITEM_DRAW_ARROW` on page 2539.



### 6.4.14 MULTIPAGE\_SKIN\_FLEX

The following picture shows the details of the skin:

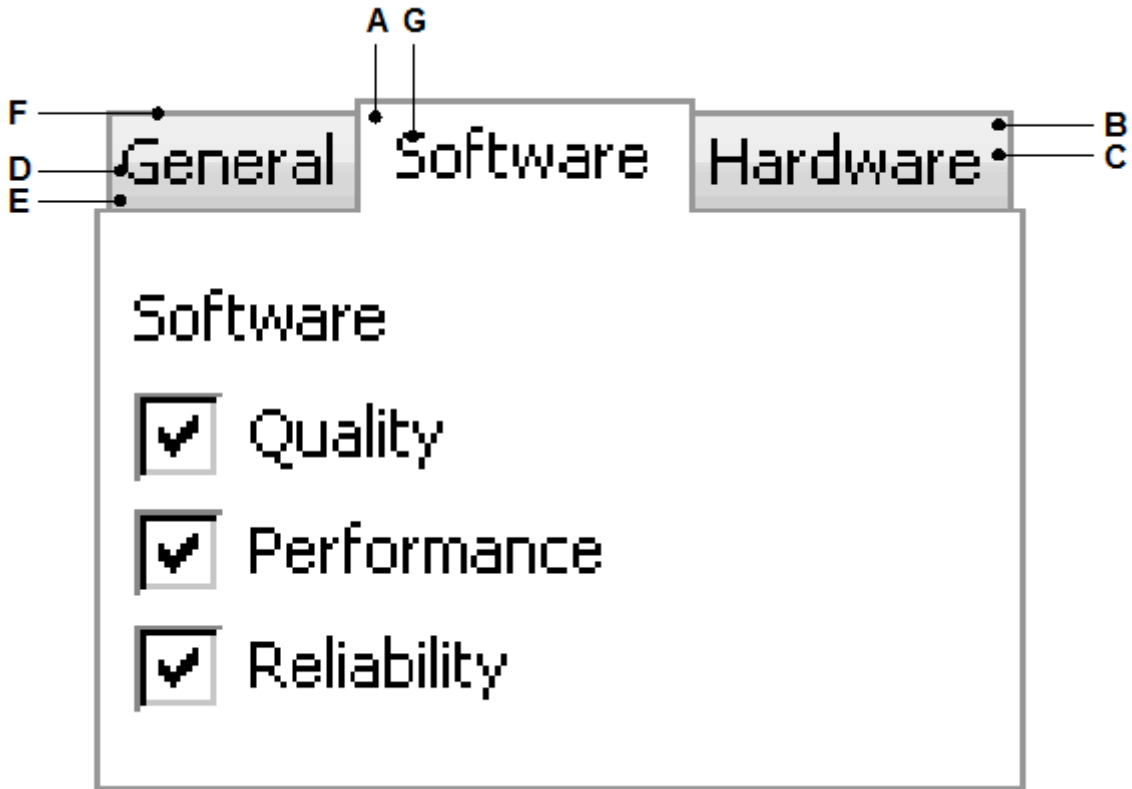

The MULTIPAGE skin consists of the tabs which are drawn using a frame and 2 horizontal gradients as background. The according text is displayed on top of the background:

| Detail | Description                          |
|--------|--------------------------------------|
| A      | Background color for selected items. |
| B      | Top color of top gradient.           |
| C      | Bottom color of top gradient.        |
| D      | Top color of bottom gradient.        |
| E      | Bottom color of bottom gradient.     |
| F      | Frame color.                         |
| G      | Text color.                          |

#### 6.4.14.1 Configuration structure

To set up the default appearance of the skin or to change it at run time configuration structures of type MULTIPAGE\_SKINFLEX\_PROPS are used:

##### Elements of structure MULTIPAGE\_SKINFLEX\_PROPS

| Data type | Element     | Description   |
|-----------|-------------|---|
| U32       | BkColor     | Background color for selected items.  |
| U32       | aBkUpper[2] | [0] - Top color of top gradient.<br>[1] - Bottom color of top gradient.       |
| U32       | aBkLower[2] | [0] - Top color of bottom gradient.<br>[1] - Bottom color of bottom gradient. |
| U32       | FrameColor  | Frame color.  |
| U32       | TextColor   | Text color.   |

### 6.4.14.2 Configuration options

The default appearance of the skin can be determined by setting custom configuration structures of the above type in `GUIConf.h`. The following table shows the available configuration options:

| Macro                                     | Description   |
|---|---|
| <code>MULTIPAGE_SKINPROPS_ENABLED</code>  | Defines the default attributes for drawing enabled tabs.  |
| <code>MULTIPAGE_SKINPROPS_SELECTED</code> | Defines the default attributes for drawing selected tabs. |
| <code>MULTIPAGE_SKINPROPS_DISABLED</code> | Defines the default attributes for drawing disabled tabs. |

### 6.4.14.3 Skinning API

The table below lists the available routines in alphabetical order:

| Routine  | Description  |
|--|--|
| <code>MULTIPAGE_DrawSkinFlex()</code>          | Skinning callback function of <code>MULTIPAGE_SKIN_FLEX</code> . (Explained at the beginning of the chapter)             |
| <code>MULTIPAGE_GetSkinFlexProps()</code>      | Returns the properties of the given <code>MULTIPAGE</code> skin. (Explained at the beginning of the chapter)             |
| <code>MULTIPAGE_SetDefaultSkin()</code>        | Sets the default skin used for new <code>MULTIPAGE</code> widgets. (Explained at the beginning of the chapter)           |
| <code>MULTIPAGE_SetDefaultSkinClassic()</code> | Sets the classical design as default for new <code>MULTIPAGE</code> widgets. (Explained at the beginning of the chapter) |
| <code>MULTIPAGE_SetSkin()</code>               | Sets a skin for the given <code>MULTIPAGE</code> widget. (Explained at the beginning of the chapter)                     |
| <code>MULTIPAGE_SetSkinClassic()</code>        | Sets the classical design for the given <code>MULTIPAGE</code> widget. (Explained at the beginning of the chapter)       |
| <code>MULTIPAGE_SetSkinFlexProps()</code>      | The function can be used to change the colors of the skin.   |

### 6.4.14.3.1 MULTIPAGE\_SetSkinFlexProps()

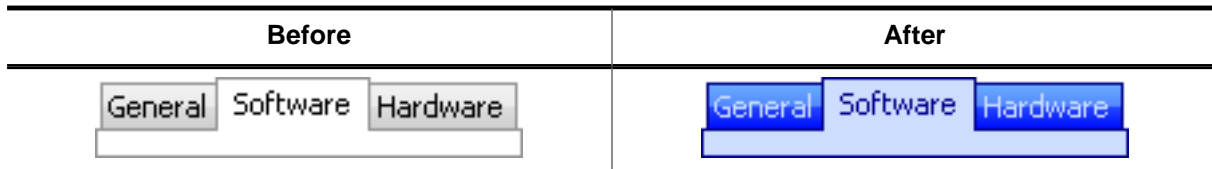

#### Description

The function can be used to change the colors of the skin.

#### Prototype

```
void MULTIPAGE_SetSkinFlexProps(const MULTIPAGE_SKINFLEX_PROPS * pProps,
                                int Index);
```

#### Parameters

| Parameter           | Description  |
|---------------------|--|
| <code>pProps</code> | Pointer to a structure of type <code>MULTIPAGE_SKINFLEX_PROPS</code> . |
| <code>Index</code>  | See table below.   |

| Permitted values for parameter <code>Index</code> |                                |
|---|--------------------------------|
| <code>MULTIPAGE_SKINFLEX_PI_ENABLED</code>        | Properties for enabled state.  |
| <code>MULTIPAGE_SKINFLEX_PI_SELECTED</code>       | Properties for selected state. |
| <code>MULTIPAGE_SKINFLEX_PI_DISABLED</code>       | Properties for disabled state. |

#### Additional information

The function passes a pointer to a `MULTIPAGE_SKINFLEX_PROPS` structure. It can be used to set up the colors of the skin. The function `MULTIPAGE_GetSkinFlexProps()` can be used to get the current attributes of the skin.

### 6.4.14.4 List of commands

The skinning routine receives a pointer to a `WIDGET_ITEM_DRAW_INFO` structure. The `Cmd` member of this structure contains the command which needs to be processed. The following table shows all commands passed to the `MULTIPAGE_SKIN_FLEX` callback function:

| Command                                  | Description                                       |
|--|---|
| <code>WIDGET_ITEM_CREATE</code>          | Is sent immediately after creating the widget.    |
| <code>WIDGET_ITEM_DRAW_BACKGROUND</code> | The skinning function should draw the background. |
| <code>WIDGET_ITEM_DRAW_FRAME</code>      | The skinning function should draw the frame.      |
| <code>WIDGET_ITEM_DRAW_TEXT</code>       | The skinning function should draw the text.       |

All commands make use of the `WIDGET_ITEM_DRAW_INFO` structure, which contains the required information to draw the widget using a skin.

#### Elements of structure `WIDGET_ITEM_DRAW_INFO`

| Data type            | Element                | Description   |
|----------------------|------------------------|---|
| <code>WM_HWIN</code> | <code>hWin</code>      | Handle to the widget.   |
| <code>int</code>     | <code>ItemIndex</code> | Index of the item to display.   |
| <code>int</code>     | <code>x0</code>        | Leftmost coordinate of the client area/current tab in window coordinates.   |
| <code>int</code>     | <code>y0</code>        | Topmost coordinate of the client area/current tab in window coordinates.    |
| <code>int</code>     | <code>x1</code>        | Rightmost coordinate of the client area/current tab in window coordinates.  |
| <code>int</code>     | <code>y1</code>        | Bottommost coordinate of the client area/current tab in window coordinates. |
| <code>void *</code>  | <code>p</code>         | Pointer to a <code>MULTIPAGE_SKIN_INFO</code> structure.                    |

#### Elements of structure `MULTIPAGE_SKIN_INFO`

| Data type                   | Element                 | Description   |
|-----------------------------|-------------------------|---|
| <code>GUI_ROTATION *</code> | <code>pRotation</code>  | <code>GUI_ROTATE_0</code> , if the <code>MULTIPAGE</code> widget is horizontal. <code>GUI_ROTATE_CW</code> , if the <code>MULTIPAGE</code> widget is vertical.        |
| <code>unsigned</code>       | <code>Align</code>      | Current alignment of the <code>MULTIPAGE</code> widget. Contains an or-combination of the bit definitions listed below.   |
| <code>int</code>            | <code>Sel</code>        | Index of the currently selected item. This helps to determine if the currently processed item is selected and therefore might require to be drawn in a different way. |
| <code>U16</code>            | <code>State</code>      | Current state of the <code>MULTIPAGE</code> widget. See table below.  |
| <code>U8</code>             | <code>FrameFlags</code> | Determines which lines of the frame need to be drawn using an or-combination of the bit definitions listed below.   |
| <code>U8</code>             | <code>PageStatus</code> | State of the current page.  |

| Possible bits set in the element <i>Align</i>      |   |
|--|---|
| MULTIPAGE_ALIGN_RIGHT                              | If set, items must be aligned to the right. Otherwise items must be aligned to the left.          |
| MULTIPAGE_ALIGN_BOTTOM                             | If set, items must be aligned to the bottom. Otherwise items must be aligned to the left.         |
| Possible bits set in the element <i>State</i>      |   |
| WIDGET_STATE_VERTICAL                              | If set, items must be drawn in vertical order. Otherwise items must be drawn in horizontal order. |
| Possible bits set in the element <i>FrameFlags</i> |   |
| MULTIPAGE_SKIN_FRAME_TOP                           | If set, the top line of the frame needs to be drawn.  |
| MULTIPAGE_SKIN_FRAME_BOTTOM                        | If set, the bottom line of the frame needs to be drawn.   |
| MULTIPAGE_SKIN_FRAME_LEFT                          | If set, the left line of the frame needs to be drawn.   |
| MULTIPAGE_SKIN_FRAME_RIGHT                         | If set, the right line of the frame needs to be drawn.  |
| Possible bits set in the element <i>PageStatus</i> |   |
| MULTIPAGE_STATE_ENABLED                            | If set, items must be drawn in vertical order. Otherwise items must be drawn in horizontal order. |

#### 6.4.14.4.1 WIDGET\_ITEM\_CREATE

The skinning routine should, if necessary, set up skin related properties like e.g. transparency or text alignment.

#### 6.4.14.4.2 WIDGET\_ITEM\_DRAW\_BACKGROUND

The skinning routine should draw the background of the given tab.

#### 6.4.14.4.3 WIDGET\_ITEM\_DRAW\_FRAME

The skinning routine should draw the surrounding frame. In case *ItemIndex* is given with -1 the frame of the client window has to be drawn. In case of  $ItemIndex \geq 0$ , a single tab should be drawn. The coordinates in the *WIDGET\_ITEM\_DRAW\_INFO* structure are set according to the *ItemIndex*.

#### 6.4.14.4.4 WIDGET\_ITEM\_DRAW\_TEXT

The skinning routine should draw the text.

### 6.4.15 PROGBAR\_SKIN\_FLEX

The following picture shows the details of the skin:

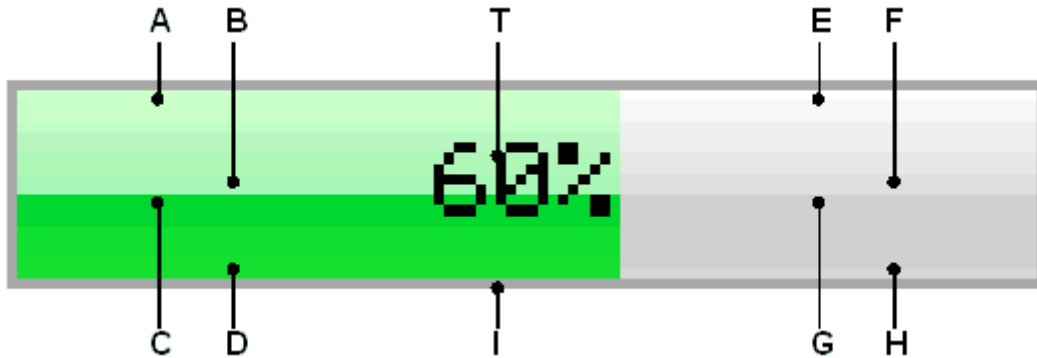

The PROGBAR skin consists of a bar with a thin border. The background is drawn by 4 gradients, a top and a bottom gradient at the left and at the right side and a text which shows the current state per default:

| Detail | Description                            |
|--------|--|
| A      | Top color of top left gradient.        |
| B      | Bottom color of top left gradient.     |
| C      | Top color of bottom left gradient.     |
| D      | Bottom color of bottom left gradient.  |
| E      | Top color of top right gradient.       |
| F      | Bottom color of top right gradient.    |
| G      | Top color of bottom right gradient.    |
| H      | Bottom color of bottom right gradient. |
| I      | Color of frame.                        |
| T      | Text (optional).                       |

#### 6.4.15.1 Configuration structure

To set up the default appearance of the skin or to change it at run time configuration structures of type `PROGBAR_SKINFLEX_PROPS` are used:

##### Elements of structure `PROGBAR_SKINFLEX_PROPS`

| Data type | Element                      | Description   |
|-----------|------------------------------|---|
| U32       | <code>aColorUpperL[2]</code> | [0] - Top color of top gradient.<br>[1] - Bottom color of top gradient.       |
| U32       | <code>aColorLowerL[2]</code> | [0] - Top color of bottom gradient.<br>[1] - Bottom color of bottom gradient. |
| U32       | <code>aColorUpperR[2]</code> | [0] - Top color of top gradient.<br>[1] - Bottom color of top gradient.       |
| U32       | <code>aColorLowerR[2]</code> | [0] - Top color of bottom gradient.<br>[1] - Bottom color of bottom gradient. |
| U32       | <code>ColorFrame</code>      | Color of frame.   |
| U32       | <code>ColorText</code>       | Color of text.  |

### 6.4.15.2 Configuration options

The default appearance of the skin can be determined by setting custom configuration structures of the above type in `GUIConf.h`. The following table shows the available configuration options:

| Macro                          | Description   |
|--------------------------------|---|
| <code>PROGBAR_SKINPROPS</code> | Defines the default attributes used for drawing the skin. |

### 6.4.15.3 Skinning API

The table below lists the available routines in alphabetical order:

| Routine                                      | Description  |
|--|--|
| <code>PROGBAR_DrawSkinFlex()</code>          | Skinning callback function of <code>PROGBAR_SKIN_FLEX</code> . (Explained at the beginning of the chapter)             |
| <code>PROGBAR_GetSkinFlexProps()</code>      | Returns the properties of the given <code>PROGBAR</code> skin. (Explained at the beginning of the chapter)             |
| <code>PROGBAR_SetDefaultSkin()</code>        | Sets the default skin used for new <code>PROGBAR</code> widgets. (Explained at the beginning of the chapter)           |
| <code>PROGBAR_SetDefaultSkinClassic()</code> | Sets the classical design as default for new <code>PROGBAR</code> widgets. (Explained at the beginning of the chapter) |
| <code>PROGBAR_SetSkin()</code>               | Sets a skin for the given <code>PROGBAR</code> widget. (Explained at the beginning of the chapter)                     |
| <code>PROGBAR_SetSkinClassic()</code>        | Sets the classical design for the given <code>PROGBAR</code> widget. (Explained at the beginning of the chapter)       |
| <code>PROGBAR_SetSkinFlexProps()</code>      | The function can be used to change the colors of the skin.   |

### 6.4.15.3.1 PROGBAR\_SetSkinFlexProps()

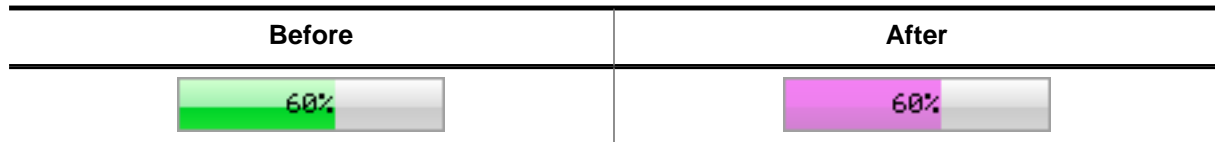

#### Additional information

The function passes a pointer to a `PROGBAR_SKINFLEX_PROPS` structure. It can be used to set up the colors of the skin. The function `PROGBAR_GetSkinFlexProps()` can be used to get the current attributes of the skin.



## 6.4.15.4 List of commands

The skinning routine receives a pointer to a `WIDGET_ITEM_DRAW_INFO` structure. The `Cmd` member of this structure contains the command which needs to be processed. The following table shows all commands passed to the `PROGBAR_SKIN_FLEX` callback function:

| Command                                  | Description                                       |
|--|---|
| <code>WIDGET_ITEM_CREATE</code>          | Is sent immediately after creating the widget.    |
| <code>WIDGET_ITEM_DRAW_BACKGROUND</code> | The skinning function should draw the background. |
| <code>WIDGET_ITEM_DRAW_FRAME</code>      | The skinning function should draw the frame.      |
| <code>WIDGET_ITEM_DRAW_TEXT</code>       | The skinning function should draw the text.       |

### 6.4.15.4.1 WIDGET\_ITEM\_CREATE

The skinning routine should, if necessary, set up skin related properties like e.g. transparency or text alignment.

### 6.4.15.4.2 WIDGET\_ITEM\_DRAW\_BACKGROUND

The skinning routine should draw the background.

#### Elements of structure `WIDGET_ITEM_DRAW_INFO`

| Data type            | Element                | Description   |
|----------------------|------------------------|---|
| <code>WM_HWIN</code> | <code>hWin</code>      | Handle to the widget.                                       |
| <code>int</code>     | <code>ItemIndex</code> | Is always 0.  |
| <code>int</code>     | <code>x0</code>        | Leftmost coordinate of widget area in window coordinates.   |
| <code>int</code>     | <code>y0</code>        | Topmost coordinate of widget area in window coordinates.    |
| <code>int</code>     | <code>x1</code>        | Rightmost coordinate of widget area in window coordinates.  |
| <code>int</code>     | <code>y1</code>        | Bottommost coordinate of widget area in window coordinates. |
| <code>void *</code>  | <code>p</code>         | Pointer to a <code>PROGBAR_SKINFLEX_INFO</code> structure.  |

#### Elements of structure `PROGBAR_SKINFLEX_INFO`

| Data type                 | Element                 | Description   |
|---------------------------|-------------------------|---|
| <code>int</code>          | <code>IsVertical</code> | 0 if the progress bar is horizontal, 1 if it is vertical. |
| <code>int</code>          | <code>Index</code>      | See table below.  |
| <code>const char *</code> | <code>pText</code>      | Pointer to the text to be drawn.                          |

| Permitted values for element <code>Index</code> |   |
|---|---|
| <code>PROGBAR_SKINFLEX_L</code>                 | Horizontal progress bar: The left part should be drawn.<br>Vertical progress bar: The top part should be drawn.     |
| <code>PROGBAR_SKINFLEX_R</code>                 | Horizontal progress bar: The right part should be drawn.<br>Vertical progress bar: The bottom part should be drawn. |

#### Additional information

The message is sent twice, once for the left/top part and once for the right/bottom part of the progress bar. The information in the `PROGBAR_SKINFLEX_INFO` structure pointed by element `p` of the `WIDGET_ITEM_DRAW_INFO` structure can be used to get the information what exactly should be drawn. The parameters `x0`, `y0`, `x1` and `y1` of the `WIDGET_ITEM_DRAW_INFO` structure mark only the area which should be drawn, left/right or top/bottom.

### 6.4.15.4.3 WIDGET\_ITEM\_DRAW\_FRAME

The skinning routine should draw the surrounding frame.

#### Elements of structure WIDGET\_ITEM\_DRAW\_INFO

| Data    | Element   | Description   |
|---------|-----------|---|
| WM_HWIN | hWin      | Handle to the widget.                                       |
| int     | ItemIndex | Is always 0.  |
| int     | x0        | Leftmost coordinate of widget area in window coordinates.   |
| int     | y0        | Topmost coordinate of widget area in window coordinates.    |
| int     | x1        | Rightmost coordinate of widget area in window coordinates.  |
| int     | y1        | Bottommost coordinate of widget area in window coordinates. |

### 6.4.15.4.4 WIDGET\_ITEM\_DRAW\_TEXT

The skinning routine should draw the text.

#### Elements of structure WIDGET\_ITEM\_DRAW\_INFO

A detailed description of the elements can be found under *WIDGET\_ITEM\_DRAW\_FRAME* on page 2544.

### 6.4.16 RADIO\_SKIN\_FLEX

The following picture shows the details of the skin:

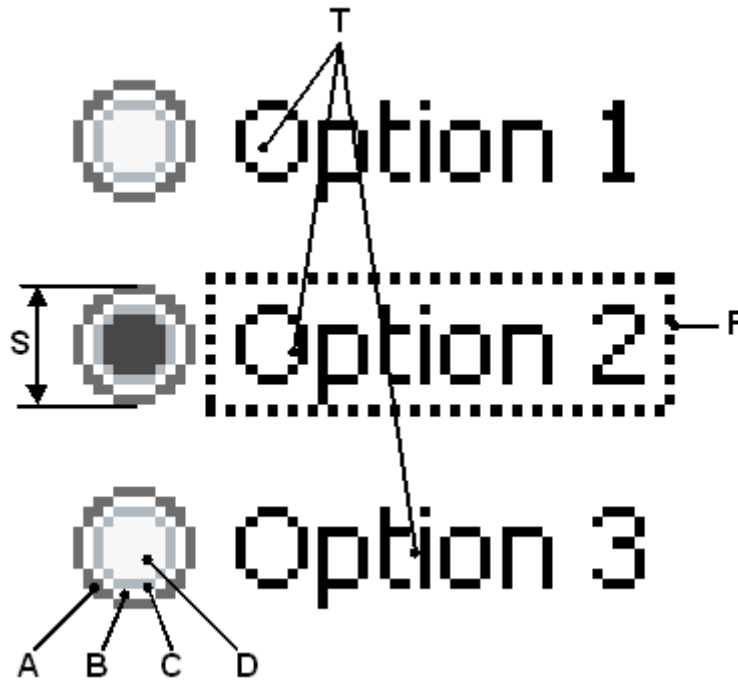

The RADIO skin consists of a configurable button and a text for each item. If the widget has the input focus the currently selected item text is surrounded by a focus rectangle:

| Detail | Description                   |
|--------|-------------------------------|
| A      | Outer color of button frame.  |
| B      | Middle color of button frame. |
| C      | Inner color of button frame.  |
| D      | Inner color of button.        |
| F      | Focus rectangle.              |
| S      | Size of button.               |
| T      | Item text.                    |

#### 6.4.16.1 Configuration structure

To set up the default appearance of the skin or to change it at run time configuration structures of type RADIO\_SKINFLEX\_PROPS are used:

##### Elements of structure RADIO\_SKINFLEX\_PROPS

| Data type | Element         | Description   |
|-----------|-----------------|---|
| U32       | aColorButton[4] | [0] - Outer color of button frame.<br>[1] - Middle color of button frame.<br>[2] - Inner color of button frame.<br>[3] - Inner color of button. |
| int       | ButtonSize      | Size of the button in pixels. Only even values are allowed. If an odd value is entered, the value will be reduced by 1.                         |

### 6.4.16.2 Configuration options

The default appearance of the skin can be determined by setting custom configuration structures of the above type in `GUIConf.h`. The following table shows the available configuration options:

| Macro                                  | Description  |
|--|--|
| <code>RADIO_SKINPROPS_CHECKED</code>   | Defines the default attributes used for checked state.   |
| <code>RADIO_SKINPROPS_UNCHECKED</code> | Defines the default attributes used for unchecked state. |

### 6.4.16.3 Skinning API

The table below lists the available routines in alphabetical order:

| Routine                                    | Description  |
|--|--|
| <code>RADIO_DrawSkinFlex()</code>          | Skinning callback function of <code>RADIO_SKIN_FLEX</code> . (Explained at the beginning of the chapter) |
| <code>RADIO_GetSkinFlexProps()</code>      | Returns the properties of the given RADIO skin. (Explained at the beginning of the chapter)              |
| <code>RADIO_SetDefaultSkin()</code>        | Sets the default skin used for new RADIO widgets. (Explained at the beginning of the chapter)            |
| <code>RADIO_SetDefaultSkinClassic()</code> | Sets the classical design as default for new RADIO widgets. (Explained at the beginning of the chapter)  |
| <code>RADIO_SetSkin()</code>               | Sets a skin for the given RADIO widget. (Explained at the beginning of the chapter)                      |
| <code>RADIO_SetSkinClassic()</code>        | Sets the classical design for the given RADIO widget. (Explained at the beginning of the chapter)        |
| <code>RADIO_SetSkinFlexProps()</code>      | The function can be used to change the colors of the skin and the size of the button.                    |

### 6.4.16.3.1 RADIO\_SetSkinFlexProps()

| Before  | After   |
|---|---|
| <input type="radio"/> Option 1<br><input checked="" type="radio"/> Option 2<br><input type="radio"/> Option 3 | <input type="radio"/> Option 1<br><input checked="" type="radio"/> Option 2<br><input type="radio"/> Option 3 |

#### Description

The function can be used to change the colors of the skin and the size of the button.

#### Prototype

```
void RADIO_SetSkinFlexProps(const RADIO_SKINFLEX_PROPS * pProps,
                           int Index);
```

#### Parameters

| Parameter           | Description  |
|---------------------|--|
| <code>pProps</code> | Pointer to a structure of type <code>RADIO_SKINFLEX_PROPS</code> . |
| <code>Index</code>  | Should be 0.   |

#### Additional information

The function passes a pointer to a `RADIO_SKINFLEX_PROPS` structure. It can be used to set up the colors and the button size of the skin. The function `RADIO_GetSkinFlexProps()` can be used to get the current attributes of the skin.

## 6.4.16.4 List of commands

The skinning routine receives a pointer to a `WIDGET_ITEM_DRAW_INFO` structure. The `Cmd` member of this structure contains the command which needs to be processed. The following table shows all commands passed to the `RADIO_SKIN_FLEX` callback function:

| Command                                 | Description   |
|---|---|
| <code>WIDGET_ITEM_CREATE</code>         | Is sent immediately after creating the widget.            |
| <code>WIDGET_ITEM_DRAW_BUTTON</code>    | The skinning function should draw the button of one item. |
| <code>WIDGET_ITEM_DRAW_FOCUS</code>     | The skinning function should draw the focus rectangle.    |
| <code>WIDGET_ITEM_DRAW_TEXT</code>      | The skinning function should draw the text of one item.   |
| <code>WIDGET_ITEM_GET_BUTTONSIZE</code> | The skinning function should return the button size.      |

### WIDGET\_ITEM\_CREATE

The skinning routine should, if necessary, set up skin related properties like e.g. transparency or text alignment.

### WIDGET\_ITEM\_DRAW\_BUTTON

The skinning routine should draw the button of one item.

### Elements of structure `WIDGET_ITEM_DRAW_INFO`

| Data type            | Element                | Description   |
|----------------------|------------------------|---|
| <code>WM_HWIN</code> | <code>hWin</code>      | Handle to the widget.   |
| <code>int</code>     | <code>ItemIndex</code> | Index of item to be drawn.                                      |
| <code>int</code>     | <code>x0</code>        | Leftmost coordinate of the button area in window coordinates.   |
| <code>int</code>     | <code>y0</code>        | Topmost coordinate of the button area in window coordinates.    |
| <code>int</code>     | <code>x1</code>        | Rightmost coordinate of the button area in window coordinates.  |
| <code>int</code>     | <code>y1</code>        | Bottommost coordinate of the button area in window coordinates. |

#### 6.4.16.4.1 WIDGET\_ITEM\_DRAW\_FOCUS

The skinning routine should draw the focus rectangle around the text of the currently selected item.

##### Elements of structure WIDGET\_ITEM\_DRAW\_INFO

| Data type | Element   | Description   |
|-----------|-----------|---|
| WM_HWIN   | hWin      | Handle to the widget.   |
| int       | ItemIndex | Index of item to be drawn.  |
| int       | x0        | Leftmost coordinate of the focus rectangle in window coordinates.   |
| int       | y0        | Topmost coordinate of the focus rectangle in window coordinates.    |
| int       | x1        | Rightmost coordinate of the focus rectangle in window coordinates.  |
| int       | y1        | Bottommost coordinate of the focus rectangle in window coordinates. |

##### Additional information

The given rectangular area in x0, y0, x1 and y1 considers the font settings and the item text.

#### 6.4.16.4.2 WIDGET\_ITEM\_DRAW\_TEXT

The skinning routine should draw the text of one item.

##### Elements of structure WIDGET\_ITEM\_DRAW\_INFO

| Data type | Element   | Description   |
|-----------|-----------|---|
| WM_HWIN   | hWin      | Handle to the widget.   |
| int       | ItemIndex | Index of item to be drawn.                                    |
| int       | x0        | Leftmost coordinate of the text area in window coordinates.   |
| int       | y0        | Topmost coordinate of the text area in window coordinates.    |
| int       | x1        | Rightmost coordinate of the text area in window coordinates.  |
| int       | y1        | Bottommost coordinate of the text area in window coordinates. |

##### Additional information

The given rectangular area in x0, y0, x1 and y1 considers the font settings and the item text.

#### 6.4.16.4.3 WIDGET\_ITEM\_GET\_BUTTONSIZE

The skinning routine should return the button size.

## 6.4.17 SCROLLBAR\_SKIN\_FLEX

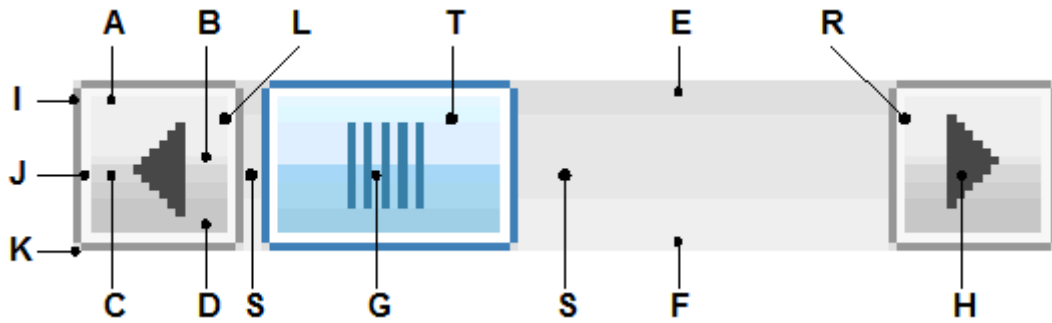

The SCROLLBAR skin consists of a left and a right button with an arrow, a shaft area and a thumb with a grasp:

| Detail | Description                      |
|--------|----------------------------------|
| A      | Top color of top gradient.       |
| B      | Bottom color of top gradient.    |
| C      | Top color of bottom gradient.    |
| D      | Bottom color of bottom gradient. |
| E      | Top color of shaft gradient.     |
| F      | Bottom color of shaft gradient.  |
| G      | Grasp of thumb area.             |
| H      | Button arrow.                    |
| I      | Outer frame color.               |
| J      | Inner frame color.               |
| K      | Color of frame edges.            |
| L      | Left button.                     |
| T      | Thumb area.                      |
| R      | Right button.                    |
| S      | Shaft area.                      |

### 6.4.17.1 Configuration structure

To set up the default appearance of the skin or to change it at run time configuration structures of type `SCROLLBAR_SKINFLEX_PROPS` are used:

#### Elements of structure `SCROLLBAR_SKINFLEX_PROPS`

| Data type | Element        | Description  |
|-----------|----------------|--|
| U32       | aColorFrame[3] | [0] - Outer frame color.<br>[1] - Inner frame color.<br>[2] - Color of frame edges |
| U32       | aColorUpper[2] | [0] - Top color of top gradient.<br>[1] - Bottom color of top gradient.            |
| U32       | aColorLower[2] | [0] - Top color of bottom gradient.<br>[1] - Bottom color of bottom gradient.      |
| U32       | aColorShaft[2] | [0] - Top color of shaft gradient.<br>[1] - Bottom color of shaft gradient.        |
| U32       | ColorArrow     | Color of button arrow.   |
| U32       | ColorGrasp     | Color of grasp.  |



### 6.4.17.2 Configuration options

The default appearance of the skin can be determined by setting custom configuration structures of the above type in `GUIConf.h`. The following table shows the available configuration options:

| Macro                                      | Description  |
|--|--|
| <code>SCROLLBAR_SKINPROPS_PRESSED</code>   | Defines the default attributes used for pressed state.   |
| <code>SCROLLBAR_SKINPROPS_UNPRESSED</code> | Defines the default attributes used for unpressed state. |

### 6.4.17.3 Skinning API

The table below lists the available routines in alphabetical order:

| Routine  | Description  |
|--|--|
| <code>SCROLLBAR_DrawSkinFlex()</code>          | Skinning callback function of <code>SCROLLBAR_SKIN_FLEX</code> . (Explained at the beginning of the chapter)             |
| <code>SCROLLBAR_GetSkinFlexProps()</code>      | Returns the properties of the given <code>SCROLLBAR</code> skin. (Explained at the beginning of the chapter)             |
| <code>SCROLLBAR_SetDefaultSkin()</code>        | Sets the default skin used for new <code>SCROLLBAR</code> widgets. (Explained at the beginning of the chapter)           |
| <code>SCROLLBAR_SetDefaultSkinClassic()</code> | Sets the classical design as default for new <code>SCROLLBAR</code> widgets. (Explained at the beginning of the chapter) |
| <code>SCROLLBAR_SetSkin()</code>               | Sets a skin for the given <code>SCROLLBAR</code> widget. (Explained at the beginning of the chapter)                     |
| <code>SCROLLBAR_SetSkinClassic()</code>        | Sets the classical design for the given <code>SCROLLBAR</code> widget. (Explained at the beginning of the chapter)       |
| <code>SCROLLBAR_SetSkinFlexProps()</code>      | The function can be used to change the colors of the skin and the size of the button.                                    |

### 6.4.17.3.1 SCROLLBAR\_SetSkinFlexProps()



#### Description

The function can be used to change the colors of the skin and the size of the button.

#### Prototype

```
void SCROLLBAR_SetSkinFlexProps(const SCROLLBAR_SKINFLEX_PROPS * pProps,
                                int Index);
```

#### Parameters

| Parameter           | Description  |
|---------------------|--|
| <code>pProps</code> | Pointer to a structure of type <code>SCROLLBAR_SKINFLEX_PROPS</code> . |
| <code>Index</code>  | Should be 0.   |

| Permitted values for parameter <code>Index</code> |                                 |
|---|---------------------------------|
| <code>SCROLLBAR_SKINFLEX_PI_PRESSED</code>        | Properties for pressed state.   |
| <code>SCROLLBAR_SKINFLEX_PI_UNPRESSED</code>      | Properties for unpressed state. |

#### Additional information

The function passes a pointer to a `SCROLLBAR_SKINFLEX_PROPS` structure. It can be used to set up the colors of the skin. The function `SCROLLBAR_GetSkinFlexProps()` can be used to get the current attributes of the skin.

## 6.4.17.4 List of commands

The skinning routine receives a pointer to a `WIDGET_ITEM_DRAW_INFO` structure. The `Cmd` member of this structure contains the command which needs to be processed. The following table shows all commands passed to the `SCROLLBAR_SKIN_FLEX` callback function:

| Command                                 | Description  |
|---|--|
| <code>WIDGET_ITEM_CREATE</code>         | Is sent immediately after creating the widget.                 |
| <code>WIDGET_ITEM_DRAW_BUTTON_L</code>  | The skinning function should draw the left button.             |
| <code>WIDGET_ITEM_DRAW_BUTTON_R</code>  | The skinning function should draw the right button.            |
| <code>WIDGET_ITEM_DRAW_OVERLAP</code>   | The skinning function should draw the overlapping area.        |
| <code>WIDGET_ITEM_DRAW_SHAFT_L</code>   | The skinning function should draw the left part of the shaft.  |
| <code>WIDGET_ITEM_DRAW_SHAFT_R</code>   | The skinning function should draw the right part of the shaft. |
| <code>WIDGET_ITEM_DRAW_THUMB</code>     | The skinning function should draw the thumb.                   |
| <code>WIDGET_ITEM_GET_BUTTONSIZE</code> | The skinning function should return the button size.           |

### 6.4.17.4.1 WIDGET\_ITEM\_DRAW\_BUTTON\_L

### 6.4.17.4.2 WIDGET\_ITEM\_DRAW\_BUTTON\_R

The skinning routine should draw a button.

#### Elements of structure `WIDGET_ITEM_DRAW_INFO`

| Data type            | Element                | Description  |
|----------------------|------------------------|--|
| <code>WM_HWIN</code> | <code>hWin</code>      | Handle to the widget.  |
| <code>int</code>     | <code>ItemIndex</code> | Index of item to be drawn.                                   |
| <code>int</code>     | <code>x0</code>        | Leftmost coordinate of the button in window coordinates.     |
| <code>int</code>     | <code>y0</code>        | Topmost coordinate of the button in window coordinates.      |
| <code>int</code>     | <code>x1</code>        | Rightmost coordinate of the button in window coordinates.    |
| <code>int</code>     | <code>y1</code>        | Bottommost coordinate of the button in window coordinates.   |
| <code>void *</code>  | <code>p</code>         | Pointer to a <code>SCROLLBAR_SKINFLEX_INFO</code> structure. |

#### Elements of structure `SCROLLBAR_SKINFLEX_INFO`

| Datatype         | Element                 | Description   |
|------------------|-------------------------|---|
| <code>int</code> | <code>IsVertical</code> | 0 if the progress bar is horizontal, 1 if it is vertical. |
| <code>int</code> | <code>State</code>      | See table below.  |

| Permitted values for element <code>State</code> |                              |
|---|------------------------------|
| <code>PRESSED_STATE_NONE</code>                 | Nothing is pressed.          |
| <code>PRESSED_STATE_RIGHT</code>                | The right button is pressed. |
| <code>PRESSED_STATE_LEFT</code>                 | The left button is pressed.  |
| <code>PRESSED_STATE_THUMB</code>                | The thumb is pressed.        |

### 6.4.17.4.3 WIDGET\_ITEM\_DRAW\_OVERLAP

The skinning routine should draw the thumb.

#### Elements of structure WIDGET\_ITEM\_DRAW\_INFO

| Data type | Element   | Description  |
|-----------|-----------|--|
| WM_HWIN   | hWin      | Handle to the widget.  |
| int       | ItemIndex | Index of item to be drawn.   |
| int       | x0        | Leftmost coordinate of the overlapping area in window coordinates.   |
| int       | y0        | Topmost coordinate of the overlapping area in window coordinates.    |
| int       | x1        | Rightmost coordinate of the overlapping area in window coordinates.  |
| int       | y1        | Bottommost coordinate of the overlapping area in window coordinates. |

#### Additional information

An overlapping area can exist if a dialog has a vertical and a horizontal scroll bar at the borders. Normally the overlapping region looks identical to the shaft area.

#### Example

The following screenshot shows a window with 2 scroll bars which have an overlapping region at the lower right corner of the client window:

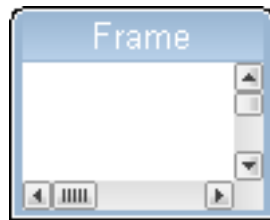

### 6.4.17.4.4 WIDGET\_ITEM\_DRAW\_SHAFT\_L

### 6.4.17.4.5 WIDGET\_ITEM\_DRAW\_SHAFT\_R

The skinning routine should draw a shaft area.

#### Elements of structure WIDGET\_ITEM\_DRAW\_INFO

| Data type | Element   | Description  |
|-----------|-----------|--|
| WM_HWIN   | hWin      | Handle to the widget.  |
| int       | ItemIndex | Index of item to be drawn.                                     |
| int       | x0        | Leftmost coordinate of the shaft area in window coordinates.   |
| int       | y0        | Topmost coordinate of the shaft area in window coordinates.    |
| int       | x1        | Rightmost coordinate of the shaft area in window coordinates.  |
| int       | y1        | Bottommost coordinate of the shaft area in window coordinates. |

#### 6.4.17.4.6 WIDGET\_ITEM\_DRAW\_THUMB

The skinning routine should draw the thumb.

#### Elements of structure WIDGET\_ITEM\_DRAW\_INFO

| Data type | Element   | Description  |
|-----------|-----------|--|
| WM_HWIN   | hWin      | Handle to the widget.  |
| int       | ItemIndex | Index of item to be drawn.                                     |
| int       | x0        | Leftmost coordinate of the thumb area in window coordinates.   |
| int       | y0        | Topmost coordinate of the thumb area in window coordinates.    |
| int       | x1        | Rightmost coordinate of the thumb area in window coordinates.  |
| int       | y1        | Bottommost coordinate of the thumb area in window coordinates. |
| void *    | p         | Pointer to a SCROLLBAR_SKINFLEX_INFO structure.                |

#### SCROLLBAR\_SKINFLEX\_INFO

A detailed description of the elements can be found under *WIDGET\_ITEM\_DRAW\_BUTTON\_L* on page 2575.

#### 6.4.17.4.7 WIDGET\_ITEM\_GET\_BUTTONSIZE

The skinning routine should return the button size. The button size means the following:

- A horizontal scroll bar should return the height of the scroll bar.
- A vertical scroll bar should return the width of the scroll bar.

#### Example

The following code can be used to return the right values in most cases:

```
int _SkinningCallback(const WIDGET_ITEM_DRAW_INFO * pDrawItemInfo) {
    SCROLLBAR_SKINFLEX_INFO * pSkinInfo;
    pSkinInfo = (SCROLLBAR_SKINFLEX_INFO *)pDrawItemInfo->p;
    switch (pDrawItemInfo->Cmd) {
        case WIDGET_ITEM_GET_BUTTONSIZE:
            return (pSkinInfo->IsVertical) ?
                pDrawItemInfo->x1 - pDrawItemInfo->x0 + 1 :
                pDrawItemInfo->y1 - pDrawItemInfo->y0 + 1;
        ...
    }
}
```

### 6.4.18 SLIDER\_SKIN\_FLEX

The following picture shows the details of the skin:

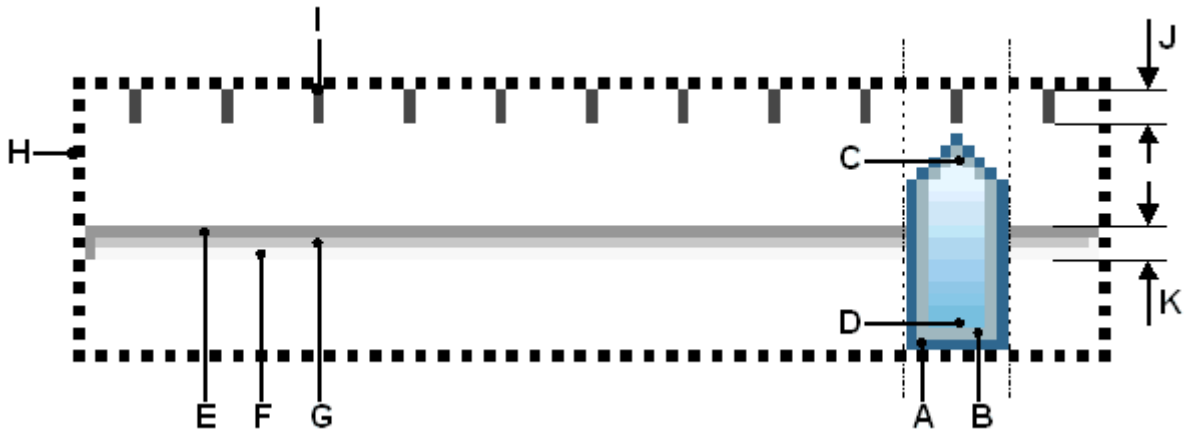

The SLIDER skin consists of a shaft with slider and tick marks above. Further a focus rectangle is shown if the widget has the input focus. The slider is drawn by a frame and a gradient:

| Detail | Description                  |
|--------|------------------------------|
| A      | Outer color of slider frame. |
| B      | Inner color of slider frame  |
| C      | Top color of gradient.       |
| D      | Bottom color of gradient.    |
| E      | First color of shaft.        |
| F      | Second color of shaft.       |
| G      | Third color of shaft.        |
| H      | Focus rectangle.             |
| I      | Tick marks.                  |
| J      | Size of a tick mark.         |
| K      | Size of the shaft.           |

#### 6.4.18.1 Configuration structure

To set up the default appearance of the skin or to change it at run time configuration structures of type SLIDER\_SKINFLEX\_PROPS are used:

#### Elements of structure SLIDER\_SKINFLEX\_PROPS

| Data type | Element        | Description  |
|-----------|----------------|--|
| U32       | aColorFrame[2] | [0] - Outer frame color.<br>[1] - Inner frame color.   |
| U32       | aColorInner[2] | [0] - Top color of gradient.<br>[1] - Bottom color of gradient.  |
| U32       | aColorShaft[3] | [0] - First frame color of shaft.<br>[1] - Second frame color of shaft.<br>[2] - Inner color of shaft. |
| U32       | ColorTick      | Color of tick marks.   |
| U32       | ColorFocus     | Color of focus rectangle.  |
| int       | TickSize       | Size of tick marks.  |

| Data type | Element   | Description    |
|-----------|-----------|----------------|
| int       | ShaftSize | Size of shaft. |

### 6.4.18.2 Configuration options

The default appearance of the skin can be determined by setting custom configuration structures of the above type in `GUIConf.h`. The following table shows the available configuration options:

| Macro                                   | Description  |
|---|--|
| <code>SLIDER_SKINPROPS_PRESSED</code>   | Defines the default attributes used for pressed state.   |
| <code>SLIDER_SKINPROPS_UNPRESSED</code> | Defines the default attributes used for unpressed state. |

### 6.4.18.3 Skinning API

The table below lists the available routines in alphabetical order:

| Routine                                     | Description   |
|---|---|
| <code>SLIDER_DrawSkinFlex()</code>          | Skinning callback function of <code>SLIDER_SKIN_FLEX</code> . (Explained at the beginning of the chapter)             |
| <code>SLIDER_GetSkinFlexProps()</code>      | Returns the properties of the given <code>SLIDER</code> skin. (Explained at the beginning of the chapter)             |
| <code>SLIDER_SetDefaultSkin()</code>        | Sets the default skin used for new <code>SLIDER</code> widgets. (Explained at the beginning of the chapter)           |
| <code>SLIDER_SetDefaultSkinClassic()</code> | Sets the classical design as default for new <code>SLIDER</code> widgets. (Explained at the beginning of the chapter) |
| <code>SLIDER_SetSkin()</code>               | Sets a skin for the given <code>SLIDER</code> widget. (Explained at the beginning of the chapter)                     |
| <code>SLIDER_SetSkinClassic()</code>        | Sets the classical design for the given <code>SLIDER</code> widget. (Explained at the beginning of the chapter)       |
| <code>SLIDER_SetSkinFlexProps()</code>      | The function can be used to change colors, tick mark and shaft size of the skin.                                      |

### 6.4.18.3.1 SLIDER\_SetSkinFlexProps()

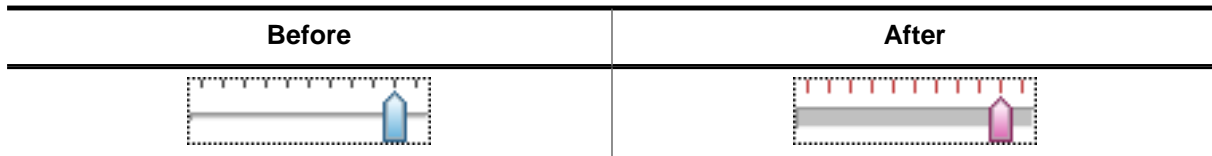

#### Description

The function can be used to change colors, tick mark and shaft size of the skin.

#### Prototype

```
void SLIDER_SetSkinFlexProps(const SLIDER_SKINFLEX_PROPS * pProps,
                             int Index);
```

#### Parameters

| Parameter              | Description   |
|------------------------|---|
| <a href="#">pProps</a> | Pointer to a structure of type <code>SLIDER_SKINFLEX_PROPS</code> . |
| <a href="#">Index</a>  | Should be 0.  |

#### Permitted values for parameter [Index](#)

|   |                                 |
|---|---------------------------------|
| <code>SLIDER_SKINFLEX_PI_PRESSED</code>   | Properties for pressed state.   |
| <code>SLIDER_SKINFLEX_PI_UNPRESSED</code> | Properties for unpressed state. |

#### Additional information

The function passes a pointer to a `SLIDER_SKINFLEX_PROPS` structure. It can be used to set up the colors of the skin. The function `SLIDER_GetSkinFlexProps()` can be used to get the current attributes of the skin.



## 6.4.18.4 List of commands

The skinning routine receives a pointer to a `WIDGET_ITEM_DRAW_INFO` structure. The `Cmd` member of this structure contains the command which needs to be processed. The following table shows all commands passed to the `SLIDER_SKIN_FLEX` callback function:

| Command                             | Description  |
|-------------------------------------|--|
| <code>WIDGET_ITEM_CREATE</code>     | Is sent immediately after creating the widget.         |
| <code>WIDGET_ITEM_DRAW_FOCUS</code> | The skinning function should draw the focus rectangle. |
| <code>WIDGET_ITEM_DRAW_SHAFT</code> | The skinning function should draw the shaft.           |
| <code>WIDGET_ITEM_DRAW_THUMB</code> | The skinning function should draw the slider.          |
| <code>WIDGET_ITEM_DRAW_TICKS</code> | The skinning function should draw the tick marks.      |

### 6.4.18.4.1 WIDGET\_ITEM\_CREATE

The skinning routine should, if necessary, set up skin related properties like e.g. transparency or text alignment.

### 6.4.18.4.2 WIDGET\_ITEM\_DRAW\_FOCUS

The skinning routine should draw the focus rectangle.

#### Elements of structure `WIDGET_ITEM_DRAW_INFO`

| Data type            | Element                | Description  |
|----------------------|------------------------|--|
| <code>WM_HWIN</code> | <code>hWin</code>      | Handle to the widget.                                      |
| <code>int</code>     | <code>ItemIndex</code> | Index of item to be drawn.                                 |
| <code>int</code>     | <code>x0</code>        | Leftmost coordinate of the widget in window coordinates.   |
| <code>int</code>     | <code>y0</code>        | Topmost coordinate of the widget in window coordinates.    |
| <code>int</code>     | <code>x1</code>        | Rightmost coordinate of the widget in window coordinates.  |
| <code>int</code>     | <code>y1</code>        | Bottommost coordinate of the widget in window coordinates. |

### 6.4.18.4.3 WIDGET\_ITEM\_DRAW\_SHAFT

The skinning routine should draw the shaft.

#### Elements of structure `WIDGET_ITEM_DRAW_INFO`

| Data type            | Element                | Description  |
|----------------------|------------------------|--|
| <code>WM_HWIN</code> | <code>hWin</code>      | Handle to the widget.  |
| <code>int</code>     | <code>ItemIndex</code> | Index of item to be drawn.                                     |
| <code>int</code>     | <code>x0</code>        | Leftmost coordinate of the widget + 1 in window coordinates.   |
| <code>int</code>     | <code>y0</code>        | Topmost coordinate of the widget + 1 in window coordinates.    |
| <code>int</code>     | <code>x1</code>        | Rightmost coordinate of the widget - 1 in window coordinates.  |
| <code>int</code>     | <code>y1</code>        | Bottommost coordinate of the widget - 1 in window coordinates. |

#### 6.4.18.4.4 WIDGET\_ITEM\_DRAW\_THUMB

The skinning routine should draw the slider itself.

##### Elements of structure WIDGET\_ITEM\_DRAW\_INFO

| Data type | Element   | Description  |
|-----------|-----------|--|
| WM_HWIN   | hWin      | Handle to the widget.                                      |
| int       | ItemIndex | Index of item to be drawn.                                 |
| int       | x0        | Leftmost coordinate of the slider in window coordinates.   |
| int       | y0        | Topmost coordinate of the slider in window coordinates.    |
| int       | x1        | Rightmost coordinate of the slider in window coordinates.  |
| int       | y1        | Bottommost coordinate of the slider in window coordinates. |
| void *    | p         | Pointer to a SLIDER_SKINFLEX_INFO structure.               |

##### Elements of structure SLIDER\_SKINFLEX\_INFO

| Data type | Element    | Description   |
|-----------|------------|---|
| int       | Width      | Width of the slider.                                |
| int       | IsPressed  | 1 if the slider is pressed, 0 if not.               |
| int       | IsVertical | 0 if the slider is horizontal, 1 if it is vertical. |

#### 6.4.18.4.5 WIDGET\_ITEM\_DRAW\_TICKS

The skinning routine should draw the tick marks.

##### Elements of structure WIDGET\_ITEM\_DRAW\_INFO

| Data type | Element   | Description  |
|-----------|-----------|--|
| WM_HWIN   | hWin      | Handle to the widget.  |
| int       | ItemIndex | Index of item to be drawn.                                     |
| int       | x0        | Leftmost coordinate of the widget + 1 in window coordinates.   |
| int       | y0        | Topmost coordinate of the widget + 1 in window coordinates.    |
| int       | x1        | Rightmost coordinate of the widget - 1 in window coordinates.  |
| int       | y1        | Bottommost coordinate of the widget - 1 in window coordinates. |
| void *    | p         | Pointer to a SLIDER_SKINFLEX_INFO structure.                   |

##### Elements of structure SLIDER\_SKINFLEX\_INFO

| Data type | Element    | Description   |
|-----------|------------|---|
| int       | Width      | Width of the slider.                                |
| int       | NumTicks   | Number of ticks to be drawn.                        |
| int       | Size       | Length of the tick mark line.                       |
| int       | IsPressed  | 1 if the slider is pressed, 0 if not.               |
| int       | IsVertical | 0 if the slider is horizontal, 1 if it is vertical. |

### 6.4.19 SPINBOX\_SKIN\_FLEX

The following picture shows the details of the skin:

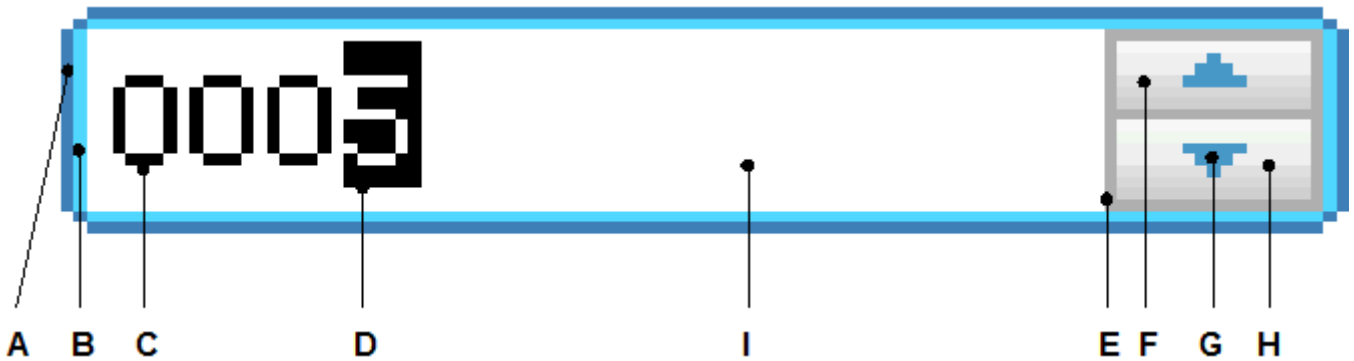

The SPINBOX skin consists of a rounded border and 2 rectangular inner areas which are drawn in dependence of the size of the EDIT widget. The background color of the EDIT widget is set to the set color of the inner area of the SPINBOX widget. The 2 buttons are drawn each with a gradient of 2 colors.

| Detail | Description                                |
|--------|--|
| A      | Outer color of surrounding frame.          |
| B      | Inner color of surrounding frame.          |
| C      | Color of the displayed value.              |
| D      | Color of the text cursor (always inverse). |
| E      | Color of the button frame.                 |
| F      | 2 color gradient of the upper button.      |
| G      | Arrow color.                               |
| H      | 2 color gradient of the lower button.      |
| I      | Background color.                          |

#### Configuration structure

To set up the default appearance of the skin or to change it at run time, configuration structures of type `SPINBOX_SKINFLEX_PROPS` are used:

#### Elements of structure `SPINBOX_SKINFLEX_PROPS`

| Data type | Element          | Description  |
|-----------|------------------|--|
| GUI_COLOR | aColorFrame[2]   | [0] - Outer color of the surrounding frame.<br>[1] - Inner color of the surrounding frame.         |
| GUI_COLOR | aColorUpper[2]   | [0] - Upper gradient color of the upper button.<br>[1] - Lower gradient color of the upper button. |
| GUI_COLOR | aColorLower[2]   | [0] - Upper gradient color of the lower button.<br>[1] - Lower gradient color of the lower button. |
| GUI_COLOR | ColorArrow       | Color of the button arrows.  |
| GUI_COLOR | ColorBk          | Color of the background.   |
| GUI_COLOR | ColorText        | Color of the text.   |
| GUI_COLOR | ColorButtonFrame | Color of the button frame.   |

### 6.4.19.1 Configuration options

The default appearance of the skin can be determined by setting custom configuration structures of the above type in `GUIConf.h`. The following table shows the available configuration options:

| Macro                                   | Description   |
|---|---|
| <code>SPINBOX_SKINPROPS_PRESSED</code>  | Defines the default attributes used for pressed state.  |
| <code>SPINBOX_SKINPROPS_FOCUSED</code>  | Defines the default attributes used for focused state.  |
| <code>SPINBOX_SKINPROPS_ENABLED</code>  | Defines the default attributes used for enabled state.  |
| <code>SPINBOX_SKINPROPS_DISABLED</code> | Defines the default attributes used for disabled state. |

### 6.4.19.2 Skinning API

The table below lists the available routines in alphabetical order:

| Routine                                      | Description  |
|--|--|
| <code>SPINBOX_DrawSkinFlex()</code>          | Skinning callback function of <code>SPINBOX_SKIN_FLEX</code> . (Explained at the beginning of the chapter) |
| <code>SPINBOX_GetSkinFlexProps()</code>      | Returns the properties of the given spinbox skin. (Explained at the beginning of the chapter)              |
| <code>SPINBOX_SetDefaultSkin()</code>        | Sets the default skin used for new spinbox widgets. (Explained at the beginning of the chapter)            |
| <code>SPINBOX_SetDefaultSkinClassic()</code> | Sets the classical design as default for new spinbox widgets. (Explained at the beginning of the chapter)  |
| <code>SPINBOX_SetSkin()</code>               | Sets a skin for the given spinbox widget. (Explained at the beginning of the chapter)                      |
| <code>SPINBOX_SetSkinClassic()</code>        | Sets the classical design for the given spinbox widget. (Explained at the beginning of the chapter)        |
| <code>SPINBOX_SetSkinFlexProps()</code>      | The function can be used to change the properties of the skin.   |

### 6.4.19.2.1 SPINBOX\_SetSkinFlexProps()

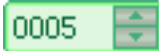
| Before  | After   |
|---|---|
|  |  |

#### Description

The function can be used to change the properties of the skin.

#### Prototype

```
void SPINBOX_SetSkinFlexProps(const SPINBOX_SKINFLEX_PROPS * pProps,
                             int Index);
```

#### Parameters

| Parameter           | Description  |
|---------------------|--|
| <code>pProps</code> | Pointer to a structure of type <code>SPINBOX_SKINFLEX_PROPS</code> . |
| <code>Index</code>  | Should be 0.   |

| Permitted values for parameter <code>Index</code> |                                |
|---|--------------------------------|
| <code>SPINBOX_SKINFLEX_PI_PRESSED</code>          | Properties for pressed state.  |
| <code>SPINBOX_SKINFLEX_PI_FOCUSED</code>          | Properties for focused state.  |
| <code>SPINBOX_SKINFLEX_PI_ENABLED</code>          | Properties for enabled state.  |
| <code>SPINBOX_SKINFLEX_PI_DISABLED</code>         | Properties for disabled state. |

#### Additional information

The function passes a pointer to a `SPINBOX_SKINFLEX_PROPS` structure. It can be used to set up the colors and the radius of the skin. The function `SPINBOX_GetSkinFlexProps()` can be used to get the current attributes of the skin.

### 6.4.19.3 List of commands

The skinning routine receives a pointer to a `WIDGET_ITEM_DRAW_INFO` structure. The `Cmd` member of this structure contains the command which needs to be processed. The following table shows all commands passed to the `SPINBOX_SKIN_FLEX` callback function:

| Command                                  | Description  |
|--|--|
| <code>WIDGET_ITEM_CREATE</code>          | Is sent immediately after creating the widget.           |
| <code>WIDGET_ITEM_DRAW_BACKGROUND</code> | The skinning function should draw the background.        |
| <code>WIDGET_ITEM_DRAW_BUTTON_U</code>   | The skinning function should draw the upper button.      |
| <code>WIDGET_ITEM_DRAW_BUTTON_D</code>   | The skinning function should draw the lower button.      |
| <code>WIDGET_ITEM_DRAW_FRAME</code>      | The skinning function should draw the surrounding frame. |

The `WIDGET_ITEM_DRAW_INFO` structure is explained at the beginning of the chapter.

#### 6.4.19.3.1 WIDGET\_ITEM\_CREATE

The skinning routine should, if necessary, set up skin related properties like e.g. transparency or text alignment.

#### 6.4.19.3.2 WIDGET\_ITEM\_DRAW\_BACKGROUND

The background should be drawn.

#### Elements of structure `WIDGET_ITEM_DRAW_INFO`

| Data type            | Element                | Description                             |
|----------------------|------------------------|---|
| <code>WM_HWIN</code> | <code>hWin</code>      | Handle to the widget.                   |
| <code>int</code>     | <code>ItemIndex</code> | See table below.                        |
| <code>int</code>     | <code>x0</code>        | Leftmost window coordinate, normally 0. |
| <code>int</code>     | <code>y0</code>        | Topmost window coordinate, normally 0.  |
| <code>int</code>     | <code>x1</code>        | Rightmost window coordinate.            |
| <code>int</code>     | <code>y1</code>        | Bottommost window coordinate.           |

#### Permitted values for element `ItemIndex`

|   |  |
|---|--|
| <code>SPINBOX_SKINFLEX_PI_PRESSED</code>  | The widget is pressed.                 |
| <code>SPINBOX_SKINFLEX_PI_FOCUSED</code>  | The widget is not pressed but focused. |
| <code>SPINBOX_SKINFLEX_PI_ENABLED</code>  | The widget is not focused but enabled. |
| <code>SPINBOX_SKINFLEX_PI_DISABLED</code> | The widget is disabled.                |

#### 6.4.19.3.3 WIDGET\_ITEM\_DRAW\_BUTTON\_U

The upper button should be drawn.

#### `WIDGET_ITEM_DRAW_INFO`

A detailed description of the elements can be found under `WIDGET_ITEM_DRAW_BACKGROUND` on page 2527.

#### **6.4.19.3.4 WIDGET\_ITEM\_DRAW\_BUTTON\_D**

The lower button should be drawn.

#### **WIDGET\_ITEM\_DRAW\_INFO**

A detailed description of the elements can be found under *WIDGET\_ITEM\_DRAW\_BACKGROUND* on page 2527.

#### **WIDGET\_ITEM\_DRAW\_FRAME**

The surrounding frame should be drawn.

#### **WIDGET\_ITEM\_DRAW\_INFO**

A detailed description of the elements can be found under *WIDGET\_ITEM\_DRAW\_BACKGROUND* on page 2527.

## 6.5 Anti-aliasing

Lines are approximated by a series of pixels that must lie at display coordinates. They can therefore appear jagged, particularly lines which are nearly horizontal or nearly vertical. This jaggedness is called aliasing.

Anti-aliasing is the smoothing of lines and curves. It reduces the jagged, stair-step appearance of any line that is not exactly horizontal or vertical. emWin supports different anti-aliasing qualities, anti-aliased fonts and high-resolution coordinates. Support for anti-aliasing is a separate software item and is not included in the emWin basic package. The software for anti-aliasing is located in the subdirectory `GUI\AntiAlias`.

### 6.5.1 Introduction

Anti-aliasing smooths curves and diagonal lines by “blending” the background color with that of the foreground. The higher the number of shades used between background and foreground colors, the better the anti-aliasing result (and the longer the computation time).

### 6.5.2 Quality of anti-aliasing

The quality of anti-aliasing is set by the routine `GUI_AA_SetFactor()`, which is explained later in this chapter. For an idea of the relationship between the anti-aliasing factor and the corresponding result, take a look at the image pictured.







The first line is drawn without anti-aliasing (factor 1). The second line is drawn anti-aliased using factor 2. This means that the number of shades from foreground to background is  $2 * 2 = 4$ . The next line is drawn with an anti-aliasing factor of 3, so there are  $3 * 3 = 9$  shades, and so on. Factor 4 should be sufficient for most applications. Increasing the anti-aliasing factor further does not improve the result significantly, but increases the calculation time dramatically.

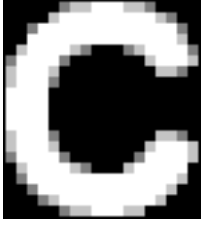

### 6.5.3 Anti-aliased fonts

Two types of anti-aliased fonts, low-quality (2bpp) and high-quality (4bpp), are supported. The routines required to display these fonts are automatically linked when using them. The following table shows the effect on drawing the character C without anti-aliasing and with both types of anti-aliased fonts:

| Font type   | Black on white   | White on black   |
|---|--|--|
| <p><b>Standard<br/>(no anti-aliasing)</b><br/>1 bpp<br/>2 shades</p>  |   |   |
| <p><b>Low-quality<br/>(anti-aliased)</b><br/>2 bpp<br/>4 shades</p>   |   |   |
| <p><b>High-quality<br/>(anti-aliased)</b><br/>4 bpp<br/>16 shades</p> |  |  |

Anti-aliased fonts can be created using the Font Converter. The general purpose of using anti-aliased fonts is to improve the appearance of text. While the effect of using high-quality anti-aliasing will be visually more pleasing than low-quality anti-aliasing, computation time and memory consumption will increase proportionally. Low-quality (2bpp) fonts require twice the memory of non-anti-aliased (1bpp) fonts; high-quality (4bpp) fonts require four times the memory.

#### 6.5.3.1 Character representation in font files

The pixels of anti-aliased fonts are represented by intensity values of 2 bits (2bpp fonts) and 4 bits (4bpp fonts). Those values are used to calculate the pixel intensities (a value between 0 and 255) for mixing the foreground with the background. The intensities are calculated per default as follows:

##### 2bpp

$$\text{Intensity} = \langle \text{value in font} \rangle \times (255 \div 3)$$

##### 4bpp

$$\text{Intensity} = \langle \text{value in font} \rangle \times (255 \div 15)$$

#### 6.5.3.2 Gamma correction

If the above described linear calculation does not lead into the expected appearance, the intensities could be set by the customer. To be able to do that gamma correction should be enabled by `GUI_AA_EnableGammaAA4()` and user defined values should be set by `GUI_AA_SetGammaAA4()`.

## 6.5.4 High-resolution coordinates

When drawing items using anti-aliasing, the same coordinates are used as for regular (non-anti-aliasing) drawing routines. This is the default mode. It is not required to consider the anti-aliasing factor in the function arguments. An anti-aliased line from (50, 100) to (100, 50) would be drawn with the following function call:

```
GUI_AA_DrawLine(50, 100, 100, 50);
```

The high-resolution feature of emWin lets you use the virtual space determined by the anti-aliasing factor and your display size. The advantage of using high-resolution coordinates is that items can be placed not only at physical positions of your display but also "between" them. The virtual space of a high-resolution pixel is illustrated below based on an anti-aliasing factor of 3:

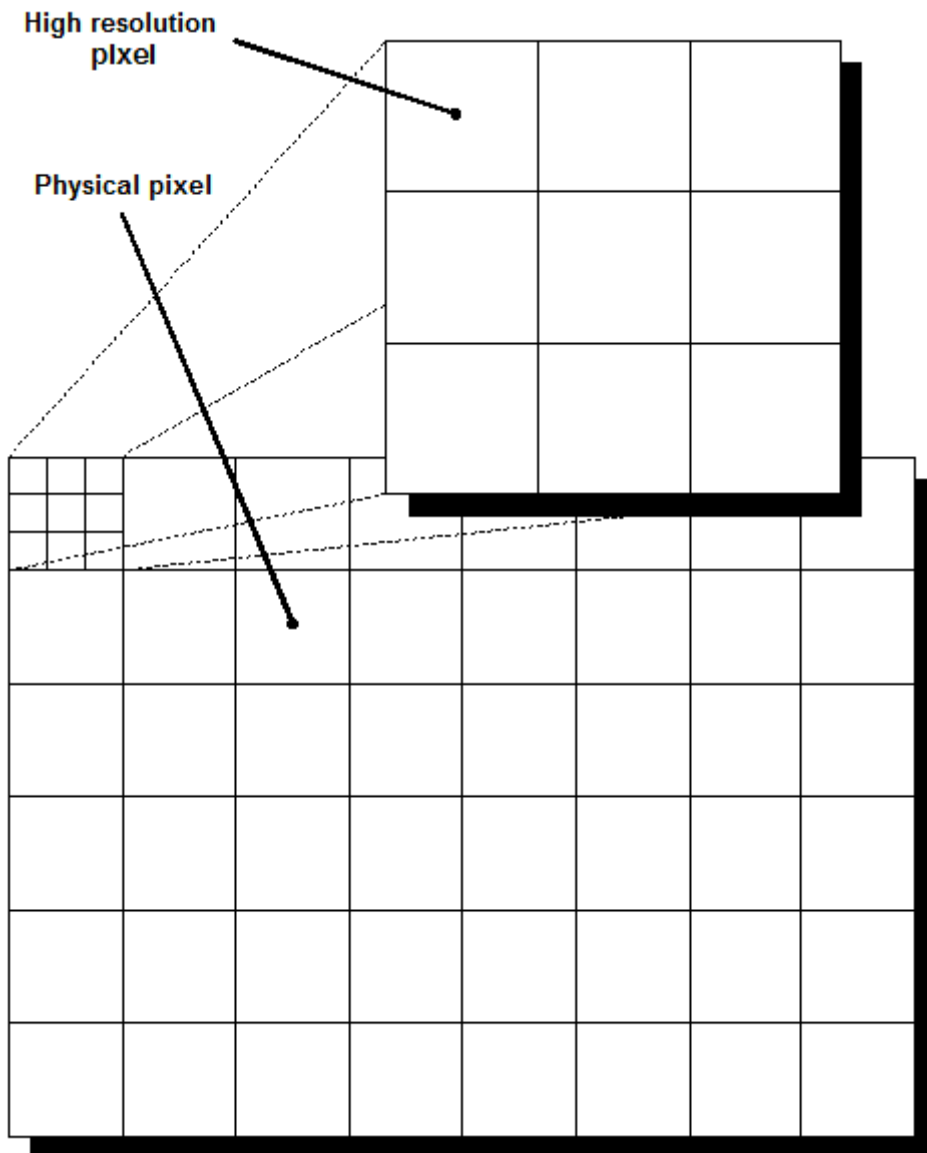

To draw a line from pixel (50, 100) to (100, 50) in high-resolution mode with anti-aliasing factor 3, you would write:

```
GUI_AA_DrawLine(150, 300, 300, 150);
```

High-resolution coordinates must be enabled with the routine `GUI_AA_EnableHiRes()`, and may be disabled with `GUI_AA_DisableHiRes()`. Both functions are explained later in the

chapter. For example programs using the high-resolution feature, see the examples at the end of the chapter.

## 6.5.5 Anti-aliasing API

The table below lists the available routines in the anti-aliasing package, in alphabetical order within their respective categories. Detailed descriptions of the routines can be found in the sections that follow.

| Routine                                  | Description   |
|--|---|
| Control functions                        |   |
| <code>GUI_AA_DisableHiRes()</code>       | Disables high-resolution coordinates.   |
| <code>GUI_AA_EnableHiRes()</code>        | Enables high-resolution coordinates.  |
| <code>GUI_AA_GetFactor()</code>          | Returns the current antialiasing quality factor.  |
| <code>GUI_AA_PreserveTrans()</code>      | Makes sure that alpha channel remains after drawing operations.   |
| <code>GUI_AA_SetBufferSize()</code>      | Sets the antialiasing buffer size which is required for managing one pixel line.  |
| <code>GUI_AA_SetFactor()</code>          | Sets the antialiasing quality factor.   |
| Drawing functions                        |   |
| <code>GUI_AA_DrawArc()</code>            | Displays an antialiased arc at a specified position in the current window.  |
| <code>GUI_AA_DrawCircle()</code>         | This functions draws an anti aliased circle.  |
| <code>GUI_AA_DrawLine()</code>           | Displays an antialiased line at a specified position in the current window.   |
| <code>GUI_AA_DrawPie()</code>            | Draws a circle sector.  |
| <code>GUI_AA_DrawPolyOutline()</code>    | Displays the outline of an antialiased polygon defined by a list of points, at a specified position in the current window and with a specified thickness. |
| <code>GUI_AA_DrawPolyOutlineEx()</code>  | Displays the outline of an antialiased polygon defined by a list of points, at a specified position in the current window and with a specified thickness. |
| <code>GUI_AA_DrawRoundedFrame()</code>   | Draws an anti-aliased rounded frame at a specified position.  |
| <code>GUI_AA_DrawRoundedFrameEx()</code> | Draws an anti-aliased rounded frame using a pointer to a <code>GUI_RECT</code> structure.   |
| <code>GUI_AA_DrawRoundedRect()</code>    | Draws the outline of an antialiased rectangle with rounded corners using the current pen size.  |
| <code>GUI_AA_DrawRoundedRectEx()</code>  | Draws the outline of an antialiased rectangle with rounded corners using the current pen size.  |
| <code>GUI_AA_FillCircle()</code>         | Displays a filled, antialiased circle at a specified position in the current window.  |
| <code>GUI_AA_FilleEllipse()</code>       | Displays a filled, antialiased ellipse at a specified position in the current window.   |
| <code>GUI_AA_FilleEllipseXL()</code>     | Displays a filled, antialiased ellipse at a specified position in the current window.   |
| <code>GUI_AA_FillPolygon()</code>        | Fills an antialiased polygon defined by a list of points, at a specified position in the current window.  |
| <code>GUI_AA_FillRoundedRect()</code>    | Draws a filled and antialiased rectangle with rounded corners.  |
| <code>GUI_AA_FillRoundedRectEx()</code>  | Draws a filled and antialiased rectangle with rounded corners.  |

| Routine                                 | Description  |
|---|--|
| <a href="#">GUI_AA_SetDrawMode()</a>    | This function determines how the background color is fetched for mixing. |
| Gamma correction                        |  |
| <a href="#">GUI_AA_EnableGammaAA4()</a> | Enables custom defined intensity values for 4bpp antialiased fonts.      |
| <a href="#">GUI_AA_GetGammaAA4()</a>    | Retrieves the currently used intensity values.                           |
| <a href="#">GUI_AA_SetGammaAA4()</a>    | Sets the intensity values to be used.                                    |

## 6.5.5.1 Control functions

### 6.5.5.1.1 GUI\_AA\_DisableHiRes()

#### Description

Disables high-resolution coordinates.

#### Prototype

```
void GUI_AA_DisableHiRes(void);
```

#### Additional information

High-resolution coordinates are disabled by default.

### 6.5.5.1.2 GUI\_AA\_EnableHiRes()

#### Description

Enables high-resolution coordinates.

#### Prototype

```
void GUI_AA_EnableHiRes(void);
```

### 6.5.5.1.3 GUI\_AA\_GetFactor()

#### Description

Returns the current antialiasing quality factor.

#### Prototype

```
int GUI_AA_GetFactor(void);
```

#### Return value

The current antialiasing factor.



#### 6.5.5.1.4 GUI\_AA\_PreserveTrans()

##### Description

For a detailed description please refer to *GUI\_PreserveTrans* on page 323.

##### Prototype

```
unsigned GUI_AA_PreserveTrans(unsigned OnOff);
```

| Parameter | Description                                       |
|-----------|---|
| OnOff     | 1 enables transparency preserving, 0 disables it. |

##### Return value

Old state.

### 6.5.5.1.5 GUI\_AA\_SetBufferSize()

#### Description

Sets the antialiasing buffer size which is required for managing one pixel line.

#### Prototype

```
void GUI_AA_SetBufferSize(int BufferSize);
```

#### Parameters

| Parameter  | Description                  |
|------------|------------------------------|
| BufferSize | Size of the buffer in bytes. |

#### Additional information

It is important, that the buffer size is at least as large as the width of the widest display. After the buffer is initialized once, there is no check if the size fits to the requirements of the drawing operation. A too small buffer size leads into undefined behavior. One byte is required for each pixel.

### 6.5.5.1.6 GUI\_AA\_SetFactor()

#### Description

Sets the antialiasing quality factor.

#### Prototype

```
void GUI_AA_SetFactor(int Factor);
```

#### Parameters

| Parameter | Description   |
|-----------|---|
| Factor    | Antialiasing quality factor to use. Minimum: 1 (no antialiasing); default: 3; maximum: 6. |

#### Additional information

For good quality and performance, it is recommended to use an antialiasing quality factor of 2-4.

## 6.5.5.2 Drawing functions

### 6.5.5.2.1 GUI\_AA\_DrawArc()

#### Description

Displays an antialiased arc at a specified position in the current window.

#### Prototype

```
void GUI_AA_DrawArc(int x0,  
                   int y0,  
                   int rx,  
                   int ry,  
                   int a0,  
                   int a1);
```

#### Parameters

| Parameter       | Description                        |
|-----------------|------------------------------------|
| <code>x0</code> | Horizontal position of the center. |
| <code>y0</code> | Vertical position of the center.   |
| <code>rx</code> | Horizontal radius.                 |
| <code>ry</code> | Vertical radius.                   |
| <code>a0</code> | Starting angle (degrees).          |
| <code>a1</code> | Ending angle (degrees).            |

#### Limitations

Currently the `ry` parameter is not available. The `rx` parameter is used instead.

#### Additional information

If working in high-resolution mode, position and radius must be in high-resolution coordinates. Otherwise they must be specified in pixels.

### 6.5.5.2.2 GUI\_AA\_DrawCircle()

#### Description

This functions draws an anti aliased circle.

#### Prototype

```
void GUI_AA_DrawCircle(int x0,  
                      int y0,  
                      int r);
```

#### Parameters

| Parameter | Description        |
|-----------|--------------------|
| x0        | X-center position. |
| y0        | Y-center position. |
| r         | Radius to be used. |

#### Additional information

This function uses the set pensize to draw the circle.

### 6.5.5.2.3 GUI\_AA\_DrawLine()

#### Description

Displays an antialiased line at a specified position in the current window.

#### Prototype

```
void GUI_AA_DrawLine(int x0,  
                    int y0,  
                    int x1,  
                    int y1);
```

#### Parameters

| Parameter | Description          |
|-----------|----------------------|
| x0        | X-starting position. |
| y0        | Y-starting position. |
| x1        | X-end position.      |
| y1        | Y-end position.      |

#### Additional information

If working in high-resolution mode, the coordinates must be in high-resolution coordinates. Otherwise they must be specified in pixels.

#### 6.5.5.2.4 GUI\_AA\_DrawPie()

##### Description

Draws a circle sector.

##### Prototype

```
void GUI_AA_DrawPie(int x0,  
                   int y0,  
                   int r,  
                   I32 a0,  
                   I32 a1);
```

##### Parameters

| Parameter       | Description  |
|-----------------|--|
| <code>x0</code> | X-position of the center of the circle in pixels of the client window. |
| <code>y0</code> | Y-position of the center of the circle in pixels of the client window. |
| <code>r</code>  | Radius of the circle (half the diameter).                              |
| <code>a0</code> | Starting angle (degrees * 1000).                                       |
| <code>a1</code> | End angle (degrees * 1000).  |

### 6.5.5.2.5 GUI\_AA\_DrawPolyOutline()

#### Note

This routine cannot be used within transparent windows!

#### Description

Displays the outline of an antialiased polygon defined by a list of points, at a specified position in the current window and with a specified thickness. The number of points is limited to 10.

#### Prototype

```
void GUI_AA_DrawPolyOutline(const GUI_POINT * pSrc,
                           int           NumPoints,
                           int           Thickness,
                           int           x,
                           int           y);
```

#### Parameters

| Parameter              | Description                                       |
|------------------------|---|
| <code>pPoint</code>    | Pointer to the polygon to display.                |
| <code>NumPoints</code> | Number of points specified in the list of points. |
| <code>Thickness</code> | <code>Thickness</code> of the outline.            |
| <code>x</code>         | X-position of origin.                             |
| <code>y</code>         | Y-position of origin.                             |

#### Additional information

The polyline drawn is automatically closed by connecting the endpoint to the starting point. The starting point must not be specified a second time as an endpoint. If working in high-resolution mode, the coordinates must be in high-resolution coordinates. Otherwise they must be specified in pixels. Per default the number of points processed by this function is limited to 10. If the polygon consists of more than 10 points the function `GUI_AA_DrawPolyOutlineEx` should be used.

#### Example

```
#define countof(Array) (sizeof(Array) / sizeof(Array[0]))
static GUI_POINT aPoints[] = {
    { 0, 0 },
    { 15, 30 },
    { 0, 20 },
    {-15, 30 }
};
void Sample(void) {
    GUI_AA_DrawPolyOutline(aPoints, countof(aPoints), 3, 150, 40);
}
```

#### Screenshot of above example





### 6.5.5.2.6 GUI\_AA\_DrawPolyOutlineEx()

#### Note

This routine cannot be used within transparent windows!

#### Description

Displays the outline of an antialiased polygon defined by a list of points, at a specified position in the current window and with a specified thickness.

#### Prototype

```
void GUI_AA_DrawPolyOutlineEx(const GUI_POINT * pSrc,
                             int           NumPoints,
                             int           Thickness,
                             int           x,
                             int           y,
                             GUI_POINT * pBuffer);
```

#### Parameters

| Parameter              | Description   |
|------------------------|---|
| <code>pPoint</code>    | Pointer to the polygon to display.                      |
| <code>NumPoints</code> | Number of points specified in the list of points.       |
| <code>Thickness</code> | <code>Thickness</code> of the outline.                  |
| <code>x</code>         | X-position of origin.                                   |
| <code>y</code>         | Y-position of origin.                                   |
| <code>pBuffer</code>   | Pointer to a buffer of <code>GUI_POINT</code> elements. |

#### Additional information

The number of polygon points is not limited by this function. Internally the function needs a buffer of `GUI_POINT` elements for calculation purpose. The number of points of the buffer needs to be  $\geq$  the number of points of the polygon. For more details, refer to `GUI_AA_DrawPolyOutline()`.

### 6.5.5.2.7 GUI\_AA\_DrawRoundedFrame()

#### Description

Draws an anti-aliased rounded frame at a specified position.

#### Prototype

```
void GUI_AA_DrawRoundedFrame( int x0,
                              int y0,
                              int x1,
                              int y1,
                              int r );
```

#### Parameters

| Parameter | Description                           |
|-----------|---------------------------------------|
| x0        | X-position of the upper left corner.  |
| y0        | Y-position of the upper left corner.  |
| x1        | X-position of the lower right corner. |
| y1        | Y-position of the lower right corner. |
| r         | Radius of frame.                      |

#### Additional information

In contrast to a rounded rectangle, an anti-aliased frame does not have semi-transparent lines on the outside. Furthermore, with increased pen size, the drawn frame stays within the given rectangular area.

### 6.5.5.2.8 GUI\_AA\_DrawRoundedFrameEx()

#### Description

Draws an anti-aliased rounded frame using a pointer to a GUI\_RECT structure.

#### Prototype

```
void GUI_AA_DrawRoundedFrameEx(const GUI_RECT * pRect,  
                               int r);
```

#### Parameters

| Parameter          | Description                    |
|--------------------|--------------------------------|
| <code>pRect</code> | Pointer to GUI_RECT structure. |
| <code>r</code>     | Radius of frame.               |

#### Additional information

See GUI\_AA\_DrawRoundedFrame().

### 6.5.5.2.9 GUI\_AA\_DrawRoundedRect()

#### Description

Draws the outline of an antialiased rectangle with rounded corners using the current pen size.

#### Prototype

```
void GUI_AA_DrawRoundedRect(int x0,  
                             int y0,  
                             int x1,  
                             int y1,  
                             int r);
```

#### Parameters

| Parameter | Description                                |
|-----------|--|
| x0        | X-position of the upper left corner.       |
| y0        | Y-position of the upper left corner.       |
| x1        | X-position of the lower right corner.      |
| y1        | Y-position of the lower right corner.      |
| r         | Radius to be used for the rounded corners. |

#### Example

```
#include "GUI.h"  
void MainTask(void) {  
    GUI_Init();  
    GUI_SetBkColor(GUI_WHITE);  
    GUI_Clear();  
    GUI_SetColor(GUI_DARKBLUE);  
    GUI_SetPenSize(5);  
    GUI_AA_DrawRoundedRect(10, 10, 50, 50, 5);  
}
```

#### Screenshot of above example



### 6.5.5.2.10 GUI\_AA\_DrawRoundedRectEx()

#### Description

Draws the outline of an antialiased rectangle with rounded corners using the current pen size.

#### Prototype

```
void GUI_AA_DrawRoundedRectEx(const GUI_RECT * pRect,  
                             int r);
```

#### Parameters

| Parameter          | Description                                |
|--------------------|--|
| <code>pRect</code> | Pointer to the rectangle to draw.          |
| <code>r</code>     | Radius to be used for the rounded corners. |

### 6.5.5.2.11 GUI\_AA\_FillCircle()

#### Description

Displays a filled, antialiased circle at a specified position in the current window.

#### Prototype

```
void GUI_AA_FillCircle(int x0,  
                      int y0,  
                      int r);
```

#### Parameters

| Parameter       | Description  |
|-----------------|--|
| <code>x0</code> | X-position of the center of the circle in pixels of the client window. |
| <code>y0</code> | Y-position of the center of the circle in pixels of the client window. |
| <code>r</code>  | Radius of the circle (half of the diameter).                           |

#### Additional information

If working in high-resolution mode, the coordinates must be in high-resolution coordinates. Otherwise they must be specified in pixels.

### 6.5.5.2.12 GUI\_AA\_FillEllipse()

#### Description

Displays a filled, antialiased ellipse at a specified position in the current window.

#### Prototype

```
void GUI_AA_FillEllipse(int x0,  
                       int y0,  
                       int rx,  
                       int ry);
```

#### Parameters

| Parameter       | Description   |
|-----------------|---|
| <code>x0</code> | X-position of the center of the ellipse in pixels of the client window. |
| <code>y0</code> | Y-position of the center of the ellipse in pixels of the client window. |
| <code>rx</code> | Radius in X of the ellipse.   |
| <code>ry</code> | Radius in Y of the ellipse.   |

#### Additional information

If working in high-resolution mode, the coordinates must be in high-resolution coordinates. Otherwise they must be specified in pixels.

### 6.5.5.2.13 GUI\_AA\_FillEllipseXL()

#### Description

Displays a filled, antialiased ellipse at a specified position in the current window.

#### Prototype

```
void GUI_AA_FillEllipseXL(int x0,  
                          int y0,  
                          int rx,  
                          int ry);
```

#### Parameters

| Parameter       | Description   |
|-----------------|---|
| <code>x0</code> | X-position of the center of the ellipse in pixels of the client window. |
| <code>y0</code> | Y-position of the center of the ellipse in pixels of the client window. |
| <code>rx</code> | Radius in X of the ellipse.   |
| <code>ry</code> | Radius in Y of the ellipse.   |

#### Additional information

If working in high-resolution mode, the coordinates must be in high-resolution coordinates. Otherwise they must be specified in pixels.

This function can be used for large ellipses.



### 6.5.5.2.14 GUI\_AA\_FillPolygon()

#### Description

Fills an antialiased polygon defined by a list of points, at a specified position in the current window.

#### Prototype

```
void GUI_AA_FillPolygon(const GUI_POINT * pPoints,
                       int NumPoints,
                       int x0,
                       int y0);
```

#### Parameters

| Parameter              | Description                                       |
|------------------------|---|
| <code>pPoint</code>    | Pointer to the polygon to display.                |
| <code>NumPoints</code> | Number of points specified in the list of points. |
| <code>x</code>         | X-position of origin.                             |
| <code>y</code>         | Y-position of origin.                             |

#### Additional information

The polyline drawn is automatically closed by connecting the endpoint to the starting point. The starting point must not be specified a second time as an endpoint. If working in high-resolution mode, the coordinates must be in high-resolution coordinates. Otherwise they must be specified in pixels.

### 6.5.5.2.15 GUI\_AA\_FillRoundedRect()

#### Description

Draws a filled and antialiased rectangle with rounded corners.

#### Prototype

```
int GUI_AA_FillRoundedRect(int x0,
                          int y0,
                          int x1,
                          int y1,
                          int r);
```

#### Parameters

| Parameter | Description                                |
|-----------|--|
| x0        | X-position of the upper left corner.       |
| y0        | Y-position of the upper left corner.       |
| x1        | X-position of the lower right corner.      |
| y1        | Y-position of the lower right corner.      |
| r         | Radius to be used for the rounded corners. |

#### Return value

- 0 On success.
- 1 On error due to invalid parameters (e.g. radius is too big).

#### Example

```
#include "GUI.h"
void MainTask(void) {
    GUI_Init();
    GUI_SetBkColor(GUI_WHITE);
    GUI_Clear();
    GUI_SetColor(GUI_DARKBLUE);
    GUI_AA_FillRoundedRect(10, 10, 54, 54, 5);
}
```

#### Screenshot of above example



### 6.5.5.2.16 GUI\_AA\_FillRoundedRectEx()

#### Description

Draws a filled and antialiased rectangle with rounded corners.

#### Prototype

```
int GUI_AA_FillRoundedRectEx(const GUI_RECT * pRect,  
                             int           r);
```

#### Parameters

| Parameter          | Description                                |
|--------------------|--|
| <code>pRect</code> | Pointer to the rectangle to draw.          |
| <code>r</code>     | Radius to be used for the rounded corners. |

#### Return value

- 0 On success.
- 1 On error due to invalid parameters (e.g. radius is too big).

### 6.5.5.2.17 GUI\_AA\_SetDrawMode()

#### Description

This function determines how the background color is fetched for mixing.

#### Prototype

```
int GUI_AA_SetDrawMode(int Mode);
```

#### Parameters

| Parameter | Description                       |
|-----------|-----------------------------------|
| Mode      | Mode to be used (see table below) |

| Permitted values for parameter Mode |   |
|-------------------------------------|---|
| GUI_AA_TRANS                        | Default behavior. Anti-aliased pixels are mixed with the current content of the frame buffer. |
| GUI_AA_NOTRANS                      | Anti-aliased pixels are mixed with the current background color set with GUI_SetBkColor().    |

#### Return value

- 0 on success
- 1 if Mode did not contain a permitted value.

#### Additional information

The default behavior of antialiasing in emWin is mixing pixels with the current content of the frame buffer. But under certain circumstances using the currently set background color (GUI\_SetBkColor()) for mixing may be an advantage. This makes it possible to redraw antialiased items completely without having to redraw the background.

### 6.5.5.3 Gamma correction

#### 6.5.5.3.1 GUI\_AA\_EnableGammaAA4()

##### Description

Enables custom defined intensity values for 4bpp antialiased fonts. As described at the beginning of that chapter per default the intensities are calculated by a linear manner. After enabling gamma correction the intensities could be set by `GUI_AA_SetGammaAA4()`.

##### Prototype

```
void GUI_AA_EnableGammaAA4(int OnOff);
```

##### Parameters

| Parameter          | Description   |
|--------------------|---|
| <code>OnOff</code> | 1 for enabling gamma correction, 0 for using linear default values. |

### 6.5.5.3.2 GUI\_AA\_GetGammaAA4()

#### Description

Retrieves the currently used intensity values.

#### Prototype

```
void GUI_AA_GetGammaAA4(U8 * pGamma);
```

#### Parameters

| Parameter              | Description  |
|------------------------|--|
| <a href="#">pGamma</a> | The pointer should point to an array of U8 values. |

#### Additional information

The function copies the currently used set of values into the given buffer.

### 6.5.5.3.3 GUI\_AA\_SetGammaAA4()

#### Description

Sets the intensity values to be used.

#### Prototype

```
void GUI_AA_SetGammaAA4(U8 * pGamma);
```

#### Parameters

| Parameter              | Description  |
|------------------------|--|
| <a href="#">pGamma</a> | The pointer should point to an array of 16 intensity values. |

#### Additional information

The function copies the values to an emWin internal buffer.

## 6.5.6 Examples

### 6.5.6.1 Different anti-aliasing factors

The following example creates diagonal lines with and without anti-aliasing. The source code is available as `AA_Lines.c` in the examples shipped with emWin.

```

/*****
 *
 *          SEGGER Microcontroller GmbH
 *
 *      Solutions for real time microcontroller applications
 *
 *
 *          emWin example code
 *
 *****/
-----
File       : AA_Lines.c
Purpose    : Shows lines with different antialiasing qualities
-----
*/
#include "GUI.h"
/*****
 *
 *      Show lines with different antialiasing qualities
 *
 *****/
*/
static void DemoAntialiasing(void) {
    int i, x1, x2, y;
    y = 2;
    //
    // Set drawing attributes
    //
    GUI_SetColor(GUI_BLACK);
    GUI_SetBkColor(GUI_WHITE);
    GUI_Clear();
    x1 = 10;
    x2 = 90;
    //
    // Draw lines without antialiasing
    //
    GUI_DispStringHCenterAt("\nNormal", (x1 + x2) / 2, 10);
    for (i = 1; i < 12; i++) {
        GUI_SetPenSize(i);
        GUI_DrawLine(x1, 40 + i * 15, x2, 40 + i * 15 + y);
    }
    x1 = 110;
    x2 = 190;
    //
    // Draw lines with antialiasing quality factor 2
    //
    GUI_AA_SetFactor(2);
    GUI_DispStringHCenterAt("Antialiased\n\nusing factor 2", (x1 + x2) / 2, 10);
    for (i = 1; i < 12; i++) {
        GUI_SetPenSize(i);
        GUI_AA_DrawLine(x1, 40 + i * 15, x2, 40 + i * 15 + y);
    }
    x1 = 210;
    x2 = 290;
    //
    // Draw lines with antialiasing quality factor 6
    //
    GUI_AA_SetFactor(6);
    GUI_DispStringHCenterAt("Antialiased\n\nusing factor 6", (x1 + x2) / 2, 10);
    for (i = 1; i < 12; i++) {
        GUI_SetPenSize(i);
        GUI_AA_DrawLine(x1, 40 + i * 15, x2, 40 + i * 15 + y);
    }
}

```



```
    }  
  }  
  /*****  
  *  
  *      MainTask  
  *  
  *****/  
  */  
void MainTask(void) {  
    GUI_Init();  
    DemoAntialiasing();  
    while(1)  
        GUI_Delay(100);  
}
```

### Screenshot of above example

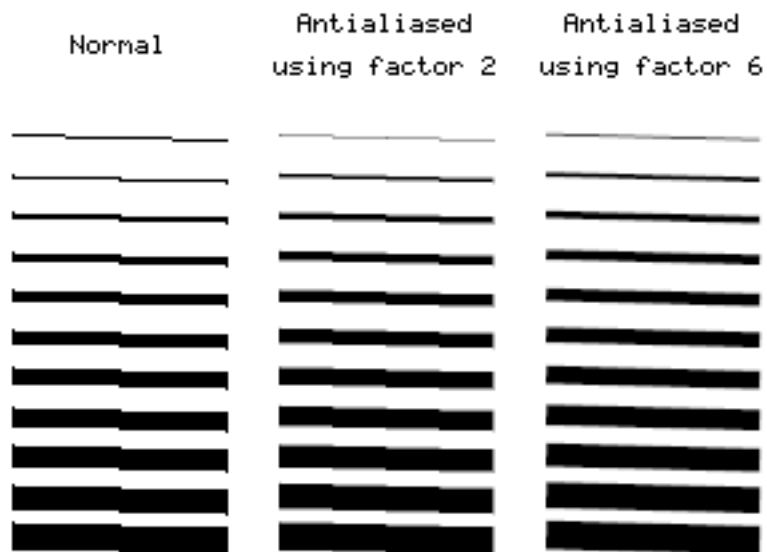

### 6.5.6.2 Lines placed on high-resolution coordinates

This example shows anti-aliased lines placed on high-resolution coordinates. It is available as `AA_HiResPixels.c`.

```

/*****
 *
 *           SEGGER Microcontroller GmbH
 *           Solutions for real time microcontroller applications
 *
 *           emWin example code
 *
 *****/
-----
File       : AA_HiResPixels.c
Purpose    : Demonstrates high resolution pixels
-----
*/
#include "GUI.h"
/*****
 *
 *           Show lines placed on high resolution pixels
 *
 *****/
*/
static void ShowHiResPixels(void) {
    int i, Factor;
    Factor = 5;
    GUI_SetBkColor(GUI_WHITE);
    GUI_SetColor(GUI_BLACK);
    GUI_Clear();
    GUI_SetLBorder(50);
    GUI_DispStringAt("This example uses high resolution pixels.\n", 50, 10);
    GUI_DispString ("Not only the physical pixels are used.\n");
    GUI_DispString ("Enabling high resolution simulates more\n");
    GUI_DispString ("pixels by using antialiasing.\n");
    GUI_DispString ("Please take a look at the magnified output\n");
    GUI_DispString ("to view the result.\n");
    GUI_SetPenSize(2);
    GUI_AA_EnableHiRes();      /* Enable high resolution */
    GUI_AA_SetFactor(Factor); /* Set quality factor */
    //
    // Drawing lines using high resolution pixels
    //
    for (i = 0; i < Factor; i++) {
        int x = (i + 1) * 5 * Factor + i - 1;
        GUI_AA_DrawLine(x, 50, x, 199);
    }
}
/*****
 *
 *           MainTask
 *
 *****/
*/
void MainTask(void) {
    GUI_Init();
    ShowHiResPixels();
    while(1) {
        GUI_Delay(100);
    }
}

```

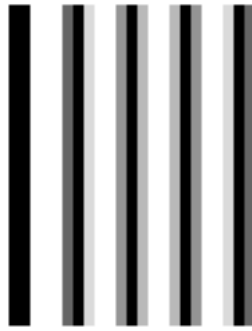
**Magnified screenshot of above example**

### 6.5.6.3 Moving pointer using high-resolution anti-aliasing

This example illustrates the use of high-resolution anti-aliasing by drawing a rotating pointer that turns 0.1 degrees with each step. There is no screenshot of this example because the effects of high-resolution anti-aliasing are only visible in the movement of the pointers. Without high-resolution the pointer appears to make short "jumps", whereas in high-resolution mode there is no apparent jumping. The example can be found as `AA_HiResAntialiasing.c`.

```

/*****
 *
 *      SEGGER Microcontroller GmbH
 *      Solutions for real time microcontroller applications
 *
 *
 *      emWin example code
 *
 *****/
-----
File       : AA_HiResAntialiasing.c
Purpose    : Demonstrates high resolution antialiasing
-----
*/
#include "GUI.H"
/*****
 *
 *      Data
 *
 *****/
*/
#define countof(Obj) (sizeof(Obj)/sizeof(Obj[0]))
static const GUI_POINT aPointer[] = {
    { 0, 3 },
    { 85, 1 },
    { 90, 0 },
    { 85, -1 },
    { 0, -3 }
};
static GUI_POINT aPointerHiRes[countof(aPointer)];
typedef struct {
    GUI_AUTODEV_INFO AutoInfo;
    GUI_POINT aPoints[countof(aPointer)];
    int Factor;
} PARAM;
/*****
 *
 *      Drawing routines
 *
 *****/
*/
static void DrawHiRes(void * p) {
    PARAM * pParam = (PARAM *)p;
    if (pParam->AutoInfo.DrawFixed) {
        GUI_ClearRect(0, 0, 99, 99);
    }
    GUI_AA_FillPolygon(pParam->aPoints, countof(aPointer),
        5 * pParam->Factor, 95 * pParam->Factor);
}
static void Draw(void * p) {
    PARAM * pParam = (PARAM *)p;
    if (pParam->AutoInfo.DrawFixed) {
        GUI_ClearRect(100, 0, 199, 99);
    }
    GUI_AA_FillPolygon(pParam->aPoints, countof(aPointer), 105, 95);
}
/*****
 *
 *      Demonstrate high resolution by drawing rotating pointers
 *
 *****/

```

```

*****
*/
static void ShowHiresAntialiasing(void) {
    GUI_AUTODEV aAuto[2];
    PARAM      Param;
    int        i;
    Param.Factor = 3;
    GUI_DispStringHCenterAt("Using\nhigh\nresolution\nmode", 50, 120);
    GUI_DispStringHCenterAt("Not using\nhigh\nresolution\nmode", 150, 120);
    //
    // Create GUI_AUTODEV objects
    //
    for (i = 0; i < countof(aAuto); i++) {
        GUI_MEMDEV_CreateAuto(&aAuto[i]);
    }
    //
    // Calculate pointer for high resolution
    //
    for (i = 0; i < countof(aPointer); i++) {
        aPointerHiRes[i].x = aPointer[i].x * Param.Factor;
        aPointerHiRes[i].y = aPointer[i].y * Param.Factor;
    }
    GUI_AA_SetFactor(Param.Factor); /* Set antialiasing factor */
    while(1) {
        for (i = 0; i < 1800; i++) {
            float Angle = (i >= 900) ? 1800 - i : i;
            Angle *= 3.1415926f / 1800;
            //
            // Draw pointer with high resolution
            //
            GUI_AA_EnableHiRes();
            GUI_RotatePolygon(Param.aPoints, aPointerHiRes, countof(aPointer), Angle);
            GUI_MEMDEV_DrawAuto(&aAuto[0], &Param.AutoInfo, DrawHiRes, &Param);
            //
            // Draw pointer without high resolution
            //
            GUI_AA_DisableHiRes();
            GUI_RotatePolygon(Param.aPoints, aPointer, countof(aPointer), Angle);
            GUI_MEMDEV_DrawAuto(&aAuto[1], &Param.AutoInfo, Draw, &Param);
            GUI_Delay(2);
        }
    }
}
/*****
*
*      MainTask
*
*****
*/
void MainTask(void) {
    GUI_Init();
    ShowHiresAntialiasing();
}

```

## 6.6 Memory Devices

Memory Devices can be used in a variety of situations, mainly to be used as a buffer for further drawing operations. For example, some images take some time to be displayed or loaded from memory. To reduce the overhead of loading or decoding images again and again, these images be drawn only once into a Memory Device. Later on only the Memory Device has to be displayed which is in most cases a simple `memcpy` operation. This will highly reduce the drawing time for frequently used images.







Memory Devices can also be used to modify a drawing before displaying it. This includes rotation, changing color and alpha values as well as blurring and blending. Further Memory Devices can be used as a last option to prevent flickering, but the first choice should be multi-buffering or a cache in case of an indirect display driver.

### Note

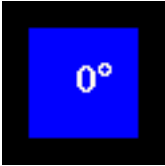
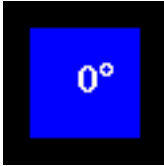
Memory Devices are an additional (optional) software item and are not shipped with the emWin basic package. The software for Memory Devices is located in the subdirectory `GUI\Memdev`.

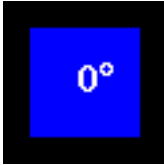
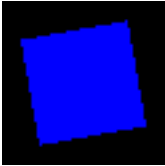
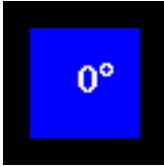
### 6.6.1 Using Memory Devices: Illustration

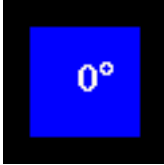
The following table shows screenshots of the same operations handled with and without a Memory Device. The objective in both cases is identical: a work piece is to be rotated and labeled with the respective angle of rotation (here, 10 degrees). In the first case (without a Memory Device) the screen must be cleared, then the polygon is redrawn in the new position and a string with the new label is written. In the second case (with a Memory Device) the same operations are performed in memory, but the screen is not updated during this time. The only update occurs when the routine `GUI_MEMDEV_CopyToLCD` is called, and this update reflects all the operations at once. Note that the initial states and final outputs of both procedures are identical.

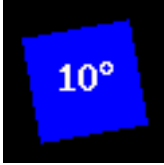
| API function  | Without Memory Device   | With Memory Device  |
|---|---|---|
| Step 0:<br>Initial state  |    |    |
| Step 1:<br><code>GUI_Clear()</code>   |    |    |
| Step 2:<br><code>GUI_DrawPolygon()</code>   |   |   |
| Step 3:<br><code>GUI_DispString()</code>  |  |  |
| Step 4:<br><code>GUI_MEMDEV_CopyToLCD()</code><br>(only when using Memory Device) |  |  |

## 6.6.2 Supported color depth (bpp)

Memory Devices are available in 4 different color depths:

- 1 bpp
- 8 bpp
- 16 bpp
- 32 bpp

### Creating Memory Devices "compatible" to the display

There are two ways to create Memory Devices. If they are used to avoid flickering, a Memory Device compatible to the display is created. This "compatible" Memory Device needs to have the same or a higher color depth as the display. emWin automatically selects the "right" type of Memory Device for the display if the functions `GUI_MEMDEV_Create()`, `GUI_MEMDEV_CreateEx()` are used.

The Window Manager, which also has the ability to use Memory Devices for some or all windows in the system, also uses these functions.

This way, the Memory Device with the lowest color depth (using the least memory) is automatically used.

### Creating Memory Devices for other purposes

Memory Devices of any type can be created using `GUI_MEMDEV_CreateFixed()`. A typical application would be the use of a Memory Device for printing as described later in this chapter.

## 6.6.3 Memory Devices and the Window Manager

The Window Manager works seamlessly with Memory Devices. Every window has a flag which tells the Window Manager if a Memory Device should be used for rendering. This flag can be specified when creating the window or set/reset at any time.

If the Memory Device flag is set for a particular window, the WM automatically uses a Memory Device when drawing the window. It creates a Memory Device before drawing a window and deletes it after the drawing operation. If enough memory is available, the whole window fits into the size of the Memory Device created by the WM. If not enough memory is available for the complete window in one Memory Device, the WM uses 'banding' for drawing the window. Details about 'banding' are described in the chapter *Banding Memory Device* on page 2679. The memory used for the drawing operation is only allocated during the drawing operation. If there is not enough memory available when (re-)drawing the window, the window is redrawn without Memory Device.



## 6.6.4 Memory Devices and multiple layers

The Memory Device API does not offer any option to specify a layer. Memory Devices are associated with the current layer at creation. The color conversion settings of the current layer are automatically used by Memory Devices.

### Example

```
//  
// Create a Memory Device associated with layer 1  
//  
GUI_SelectLayer(1);  
hMem = GUI_MEMDEV_Create(0, 0, 100, 100);  
GUI_MEMDEV_Select(hMem);  
GUI_DrawLine(0, 0, 99, 99);  
GUI_MEMDEV_Select(0);  
//  
// Select layer 0  
//  
GUI_SelectLayer(0);  
//  
// The following line copies the Memory Device to layer 1 and not to layer 0  
//  
GUI_MEMDEV_CopyToLCD(hMem);
```

## 6.6.5 Memory requirements

If creating a Memory Device the required number of bytes depends on the color depth of the Memory Device and whether transparency support is needed or not.

### Memory usage without transparency support

The following table shows the memory requirement in dependence of the system color depth for Memory Devices without transparency support.

| Color depth of Memory Device | System color depth (LCD_BITSPERPIXEL) | Memory usage  |
|------------------------------|---------------------------------------|---|
| 1 bpp                        | 1 bpp                                 | 1 byte / 8 pixels:<br>$(XSIZE + 7) \div 8 \times YSIZE$ |
| 8 bpp                        | 2, 4 and 8 bpp                        | $XSIZE \times YSIZE$                                    |
| 16 bpp                       | 12 and 16 bpp                         | 2 bytes / pixel:<br>$XSIZE \times YSIZE \times 2$       |
| 32 bpp                       | 18, 24 and 32 bpp                     | 4 bytes / pixel:<br>$XSIZE \times YSIZE \times 4$       |

### Example

A Memory Device of 111 pixels in X and 33 pixels in Y should be created. It should be compatible to a display with a color depth of 12 bpp and should support transparency. The required number of bytes can be calculated as follows:

$$\text{Number of required bytes} = (111 \times 2 + (111 + 7) \div 8) \times 33 = 7788 \text{ bytes}$$

### Memory usage with transparency support

If a Memory Device should support transparency it needs one additional byte / 8 pixels for internal management.

| Color depth of Memory Device | System color depth (LCD_BITSPERPIXEL) | Memory usage   |
|------------------------------|---------------------------------------|--|
| 1 bpp                        | 1 bpp                                 | 2 byte / 8 pixels:<br>$(XSIZE + 7) \div 8 \times YSIZE \times 2$                             |
| 8 bpp                        | 2, 4 and 8 bpp                        | 1 bytes / pixel + 1 byte / 8 pixels:<br>$(XSIZE + (XSIZE + 7) \div 8) \times YSIZE$          |
| 16 bpp                       | 12 and 16 bpp                         | 2 bytes / pixel + 1 byte / 8 pixels:<br>$(XSIZE \times 2 + (XSIZE + 7) \div 8) \times YSIZE$ |
| 32 bpp                       | 18, 24 and 32 bpp                     | 4 bytes / pixel:<br>$XSIZE \times 4 \times YSIZE$  |

### Example

A Memory Device of 200 pixels in X and 50 pixels in Y should be created. It should be compatible to a display with a color depth of 4bpp and should support transparency. The required number of bytes can be calculated as follows:

$$\text{Number of required bytes} = (200 + (200 + 7) \div 8) \times 50 = 11250 \text{ bytes}$$

### Memory usage with window animation functions

One static Memory Device is created for each, the given window and all of its child window. The color depth is always 32bpp.

## 6.6.6 Performance

Using Memory Devices typically does not significantly affect performance. When Memory Devices are used, the work of the driver is easier: It simply transfers bitmaps to the display controller. On systems with slow drivers (for example displays connected via serial interface), the performance is better if Memory Devices are used; on systems with a fast driver (such as memory mapped display memory, `GUIDRV_Lin` and others) the use of Memory Devices costs some performance.

If 'banding' is needed, the used time to draw a window increases with the number of bands. The more memory available for Memory Devices, the better the performance.

## 6.6.7 Basic functions

The following routines are those that are normally called when using Memory Devices. Basic usage is rather simple:

1. Create the Memory Device (using `GUI_MEMDEV_Create()`).
2. Activate it (using `GUI_MEMDEV_Select()`).
3. Execute drawing operations.
4. Copy the result into the display (using `GUI_MEMDEV_CopyToLCD()`).
5. Delete the Memory Device if you no longer need it (using `GUI_MEMDEV_Delete()`).
6. De-select the Memory Device (using `GUI_MEMDEV_Select(0)` or with the return value of the previous call of `GUI_MEMDEV_Select()`).

## 6.6.8 In order to be able to use Memory Devices...

Memory Devices are enabled by default. In order to optimize performance of the software, support for Memory Devices can be switched off in the configuration file `GUIConf.h` by including the following line:

```
#define GUI_SUPPORT_MEMDEV 0
```

If this line is in the configuration file and you want to use Memory Devices, either delete the line or change the define to 1.

## 6.6.9 MultiLayer / MultiDisplay configuration

As explained earlier in this chapter Memory Devices "compatible" to the display needs to have the same or a higher color depth as the display. When creating a Memory Device compatible to the display `emWin` "knows" the color depth of the currently selected layer/display and automatically uses the lowest color depth.

## 6.6.10 Configuration options

| Type | Macro                                       | Default | Description   |
|------|---|---------|---|
| B    | <code>GUI_USE_MEMDEV_1BPP_FOR_SCREEN</code> | 1       | Enables the use of 1bpp Memory Devices with displays of 1bpp color depth. |

### GUI\_USE\_MEMDEV\_1BPP\_FOR\_SCREEN

On systems with a display color depth  $\leq 8$ bpp the default color depth of Memory Devices compatible to the display is 8bpp. To enable the use of 1bpp Memory Devices with displays of 1bpp color depth the following line should be added to the configuration file `GUIConf.h`:

```
#define GUI_USE_MEMDEV_1BPP_FOR_SCREEN 0
```

## 6.6.11 Memory Device API

The table below lists the available routines of the emWin Memory Device API. All functions are listed in alphabetical order within their respective categories. Detailed descriptions of the routines can be found in the sections that follow.

### Functions

| Routine                                    | Description  |
|--|--|
| Basic functions                            |  |
| <code>GUI_MEMDEV_Clear()</code>            | Marks the entire contents of a Memory Device as "unchanged".   |
| <code>GUI_MEMDEV_ClearAlpha()</code>       | Clears all alpha values in the given memory device.  |
| <code>GUI_MEMDEV_CopyFromLCD()</code>      | Reads back the content of the display and stores it in the given Memory Device.                                    |
| <code>GUI_MEMDEV_CopyToLCD()</code>        | Copies the contents of a Memory Device from memory to the LCD.   |
| <code>GUI_MEMDEV_CopyToLCDAA()</code>      | Copies the contents of a Memory Device (antialiased) to the LCD.   |
| <code>GUI_MEMDEV_CopyToLCDAt()</code>      | Copies the contents of a Memory Device to the LCD at the given position.   |
| <code>GUI_MEMDEV_Create()</code>           | Creates the Memory Device (first step).  |
| <code>GUI_MEMDEV_CreateCopy()</code>       | This function creates a copy from a memory device.   |
| <code>GUI_MEMDEV_CreateEx()</code>         | Creates a Memory Device.   |
| <code>GUI_MEMDEV_CreateFixed()</code>      | Creates a Memory Device with dedicated color depth color conversion.   |
| <code>GUI_MEMDEV_CreateFixed32()</code>    | Creates a 32bpp Memory Device.   |
| <code>GUI_MEMDEV_Delete()</code>           | Deletes a Memory Device.   |
| <code>GUI_MEMDEV_DrawPerspectiveX()</code> | Draws the given Memory Device perspective distorted into the current selected device.                              |
| <code>GUI_MEMDEV_GetBitsPerPixel()</code>  | Returns the color depth of given Memory Device.  |
| <code>GUI_MEMDEV_GetDataPtr()</code>       | Returns a pointer to the data area (image area) of a Memory Device.  |
| <code>GUI_MEMDEV_GetSelMemdev()</code>     | Returns a handle to the currently selected Memory Device.  |
| <code>GUI_MEMDEV_GetXSize()</code>         | Returns the X-size (width) of a Memory Device.   |
| <code>GUI_MEMDEV_GetYSize()</code>         | Returns the Y-size (height) of a Memory Device in pixels.  |
| <code>GUI_MEMDEV_MarkDirty()</code>        | Marks a rectangle area as dirty.   |
| <code>GUI_MEMDEV_PunchOutDevice()</code>   | Punches out a shape of a Memory Device defined by a 8bpp mask Memory Device.                                       |
| <code>GUI_MEMDEV_ReduceYSize()</code>      | Reduces the Y-size of a Memory Device.   |
| <code>GUI_MEMDEV_Rotate()</code>           | Rotates and scales a Memory Device and writes the result into a Memory Device using the 'nearest neighbor' method. |
| <code>GUI_MEMDEV_RotateAlpha()</code>      | Rotates and scales a Memory Device and blends in the result into a Memory Device                                   |

| Routine                                  | Description   |
|--|---|
|  | using the 'nearest neighbor' method and the given alpha value.  |
| <code>GUI_MEMDEV_RotateHQ()</code>       | Rotates and scales a Memory Device and writes the result into a Memory Device using the 'high quality' method.  |
| <code>GUI_MEMDEV_RotateHQAlpha()</code>  | Rotates and scales a Memory Device and blends in the result into a Memory Device using the 'high quality' method and the given alpha value.                                     |
| <code>GUI_MEMDEV_RotateHQHR()</code>     | Rotates and scales a Memory Device and writes the result into a Memory Device using the 'high quality' as well as the 'high resolution' method.                                 |
| <code>GUI_MEMDEV_RotateHQT()</code>      | Rotates and scales a Memory Device and writes the result into a Memory Device using the 'high quality' method. (Optimized for images with a large amount of transparent pixels) |
| <code>GUI_MEMDEV_RotateHR()</code>       | Rotates and scales a Memory Device and writes the result into a Memory Device using the 'high resolution' method.   |
| <code>GUI_MEMDEV_Select()</code>         | Activates a Memory Device (or activates LCD if handle is 0).  |
| <code>GUI_MEMDEV_SerializeBMP()</code>   | Creates a BMP file from the given Memory Device.  |
| <code>GUI_MEMDEV_SerializeExBMP()</code> | Creates a BMP file from a given rectangular area of a memory device.  |
| <code>GUI_MEMDEV_SetOrg()</code>         | Changes the origin of the Memory Device on the LCD.   |
| <code>GUI_MEMDEV_Write()</code>          | Writes the content of the given Memory Device into the currently selected device.   |
| <code>GUI_MEMDEV_WriteAlpha()</code>     | Writes the content of the given Memory Device into the currently selected device using alpha blending.  |
| <code>GUI_MEMDEV_WriteAlphaAt()</code>   | Writes the content of the given Memory Device into the currently selected device at the specified position using alpha blending.  |
| <code>GUI_MEMDEV_WriteAt()</code>        | Writes the content of the given Memory Device into the currently selected device at the specified position.   |
| <code>GUI_MEMDEV_WriteEx()</code>        | Writes the content of the given Memory Device into the currently selected device at position (0, 0) using alpha blending and scaling.   |
| <code>GUI_MEMDEV_WriteExAt()</code>      | Writes the content of the given Memory Device into the currently selected device at the specified position using alpha blending and scaling.                                    |
| <code>GUI_MEMDEV_WriteOpaque()</code>    | Writes the content of the given Memory Device into the currently selected device.   |
| <code>GUI_MEMDEV_WriteOpaqueAt()</code>  | Writes the content of the given Memory Device into the currently selected device at the specified position.   |

| Routine  | Description  |
|--|--|
| <code>GUI_SelectLCD()</code>                         | Selects the LCD as target for drawing operations.  |
| <b>Banding Memory Device</b>                         |  |
| <code>GUI_MEMDEV_Draw()</code>                       | Use a Memory Device for drawing.   |
| <b>Auto device object functions</b>                  |  |
| <code>GUI_MEMDEV_CreateAuto()</code>                 | Creates an auto device object.   |
| <code>GUI_MEMDEV_DeleteAuto()</code>                 | Deletes an auto device object.   |
| <code>GUI_MEMDEV_DrawAuto()</code>                   | Executes a specified drawing routine using a banding Memory Device.                          |
| <b>Measurement device object functions</b>           |  |
| <code>GUI_MEASDEV_ClearRect()</code>                 | Clears the measurement rectangle.  |
| <code>GUI_MEASDEV_Create()</code>                    | Creates a measurement device.  |
| <code>GUI_MEASDEV_Delete()</code>                    | Deletes a measurement device.  |
| <code>GUI_MEASDEV_GetRect()</code>                   | Retrieves the measurement result.  |
| <code>GUI_MEASDEV_Select()</code>                    | Selects a measurement device as target for drawing operations.                               |
| <b>Animation functions</b>                           |  |
| <code>GUI_MEMDEV_FadeInDevices()</code>              | Performs fading in one device over another Memory Device.                                    |
| <code>GUI_MEMDEV_FadeOutDevices()</code>             | Performs fading out one device overlaying another Memory Device.                             |
| <code>GUI_MEMDEV_SetAnimationCallback()</code>       | Sets a user defined callback function to be called while animations are processed.           |
| <code>GUI_MEMDEV_SetTimePerFrame()</code>            | Sets the minimum time used for one animation frame.  |
| <b>Animation functions (Window Manager required)</b> |  |
| <code>GUI_MEMDEV_FadeInWindow()</code>               | Fades in a window by animating the alpha value from transparent to opaque.                   |
| <code>GUI_MEMDEV_FadeOutWindow()</code>              | Fades out a window animating the alpha value from opaque to transparent.                     |
| <code>GUI_MEMDEV_MoveInWindow()</code>               | Moves a window into the screen.  |
| <code>GUI_MEMDEV_MoveOutWindow()</code>              | Moves a window out of the screen.  |
| <code>GUI_MEMDEV_ShiftInWindow()</code>              | Shifts a Window in a specified direction into the screen to its actual position.             |
| <code>GUI_MEMDEV_ShiftOutWindow()</code>             | Shifts a Window in a specified direction out of the screen from its actual position.         |
| <code>GUI_MEMDEV_SwapWindow()</code>                 | Swaps a window with the old content of the target area.                                      |
| <b>Blending, Blurring and Dithering functions</b>    |  |
| <code>GUI_MEMDEV_BlendColor32()</code>               | Blends a window with the given color and blending intensity.                                 |
| <code>GUI_MEMDEV_CreateBlurredDevice32()</code>      | Creates a blurred copy of the given Memory Device using the currently set blurring function. |
| <code>GUI_MEMDEV_CreateBlurredDevice32HQ()</code>    | Creates a blurred copy of the given Memory Device at high quality.                           |
| <code>GUI_MEMDEV_CreateBlurredDevice32LQ()</code>    | Creates a blurred copy of the given Memory Device at low quality.                            |

| Routine  | Description   |
|--|---|
| <code>GUI_MEMDEV_Dither32()</code>                               | The function dithers the given memory device using the given fixed palette mode.                  |
| <code>GUI_MEMDEV_SetBlurHQ()</code>                              | Sets the blurring behavior of the function <code>GUI_MEMDEV_CreateBlurredDevice32()</code> to HQ. |
| <code>GUI_MEMDEV_SetBlurLQ()</code>                              | Sets the blurring behavior of the function <code>GUI_MEMDEV_CreateBlurredDevice32()</code> to LQ. |
| <b>Blending and Blurring functions (Window Manager required)</b> |   |
| <code>GUI_MEMDEV_BlendWinBk()</code>                             | Blends the background of a window.  |
| <code>GUI_MEMDEV_BlurAndBlendWinBk()</code>                      | Blurs and blends the background of a window.  |
| <code>GUI_MEMDEV_BlurWinBk()</code>                              | Blurs the background of a window.   |
| <b>Setting up multiple buffering for animation functions</b>     |   |
| <code>GUI_MEMDEV_MULTIBUF_Enable()</code>                        | Enable use of multiple buffers for memory device animation functions.                             |

## Defines

| Group of defines                        | Description  |
|---|--|
| <code>Color conversion routines</code>  | Defines the desired color conversion routine for a memory device.    |
| <code>Direction symbols</code>          | Direction in which a window should be moved to using memory devices. |
| <code>Memory device color depths</code> | Available color depths for fixed memory devices.                     |
| <code>Memory device flags</code>        | Flags to be used for the creation of a memory device.                |

## 6.6.11.1 Basic functions

### 6.6.11.1.1 GUI\_MEMDEV\_Clear()

#### Description

Marks the entire contents of a Memory Device as “unchanged”.

#### Prototype

```
void GUI_MEMDEV_Clear(GUI_MEMDEV_Handle hMem);
```

#### Parameters

| Parameter         | Description                |
|-------------------|----------------------------|
| <code>hMem</code> | Handle to a Memory Device. |

#### Additional information

The next drawing operation with `GUI_MEMDEV_CopyToLCD()` will then write only the bytes modified between `GUI_MEMDEV_Clear()` and `GUI_MEMDEV_CopyToLCD()`.



### 6.6.11.1.2 GUI\_MEMDEV\_ClearAlpha()

#### Description

Clears all alpha values in the given Memory Device with the help of an 1bpp Memory Device mask.

#### Prototype

```
int GUI_MEMDEV_ClearAlpha(GUI_MEMDEV_Handle hMemData,
                          GUI_MEMDEV_Handle hMemMask);
```

#### Parameters

| Parameter                | Description   |
|--------------------------|---|
| <a href="#">hMemData</a> | Handle to a Memory Device. Must be a 32bpp Memory Device.   |
| <a href="#">hMemMask</a> | Optional handle to a Memory Device mask. Must be an 1bpp Memory Device with the same size as the <a href="#">hMemData</a> handle. |

#### Return value

- 0 on success
- 1 on error.

#### Additional information

The Memory Device mask must have the same dimensions as the given [hMemData](#) Memory Device. To use the Memory Device mask, an area has to be specified where the alpha values should be cleared. To do so basic drawing functions should be used. The function sets all pixels of the data memory device to opaque, which have the index value 1 in the mask memory device. If [hMemMask](#) is 0, the alpha values of the whole memory device will be set to opaque. No transparency remains then.

#### Example

```
#include "GUI.h"
/*****
 *
 *      MainTask
 */
void MainTask(void) {
    GUI_MEMDEV_Handle hMemData;
    GUI_MEMDEV_Handle hMemMask;
    GUI_Init();
    //
    // Background
    //
    GUI_SetBkColor(GUI_DARKBLUE);
    GUI_Clear();
    GUI_DrawGradientV(0, 0, 320, 240, GUI_BLUE, GUI_RED);
    //
    // Mask device
    //
    hMemMask = GUI_MEMDEV_CreateFixed(0, 0, 320, 240, GUI_MEMDEV_NOTRANS,
                                     GUI_MEMDEV_APILIST_1, GUICC_1);

    GUI_MEMDEV_Select(hMemMask);
    GUI_SetPenSize(8);
    GUI_DrawLine(0, 240, 320, 0);
    GUI_DrawLine(0, 0, 320, 240);
    GUI_MEMDEV_Select(0);
    //
    // Data Device
    //
```

```

hMemData = GUI_MEMDEV_CreateFixed(0, 0, 320, 240, GUI_MEMDEV_NOTRANS,
                                  GUI_MEMDEV_APILIST_32, GUICC_8888);

GUI_MEMDEV_Select(hMemData);
GUI_Clear();
GUI_DrawGradientH(0, 0, 320, 240, GUI_BLUE, GUI_TRANSPARENT);
GUI_MEMDEV_Select(0);
//
// Calling GUI_MEMDEV_ClearAlpha()
//
GUI_MEMDEV_ClearAlpha(hMemData, hMemMask);
//
// Result
//
GUI_MEMDEV_Write(hMemData);
while (1) {
    GUI_Delay(100);
}
}

```

## Screenshots

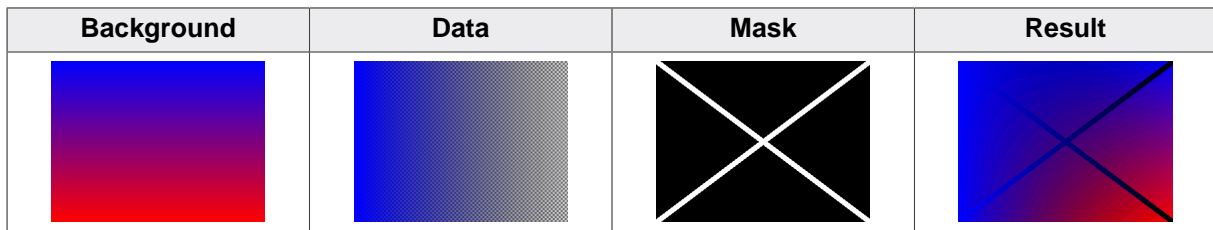

### 6.6.11.1.3 GUI\_MEMDEV\_CopyFromLCD()

#### Description

Reads back the content of the display and stores it in the given Memory Device.

#### Prototype

```
void GUI_MEMDEV_CopyFromLCD(GUI_MEMDEV_Handle hMem);
```

#### Parameters

| Parameter            | Description                |
|----------------------|----------------------------|
| <a href="#">hMem</a> | Handle to a Memory Device. |

#### 6.6.11.1.4 GUI\_MEMDEV\_CopyToLCD()

##### Description

Copies the contents of a Memory Device from memory to the LCD.

##### Prototype

```
void GUI_MEMDEV_CopyToLCD(GUI_MEMDEV_Handle hMem);
```

##### Parameters

| Parameter            | Description                |
|----------------------|----------------------------|
| <a href="#">hMem</a> | Handle to a Memory Device. |

##### Additional information

This function ignores the clipping area of the Window Manager as well as the alpha channel. Therefore using this function from within a paint event is not recommended. In order to display a Memory Device regarding the clipping area as well as the alpha channel, the function `GUI_MEMDEV_WriteAt()` should be used instead.

### 6.6.11.1.5 GUI\_MEMDEV\_CopyToLCDAA()

#### Description

Copies the contents of a Memory Device (antialiased) to the LCD.

#### Prototype

```
void GUI_MEMDEV_CopyToLCDAA(GUI_MEMDEV_Handle hMem);
```

#### Parameters

| Parameter | Description                |
|-----------|----------------------------|
| hMem      | Handle to a Memory Device. |

#### Additional information

The device data is handled as antialiased data. A matrix of 2x2 pixels is converted to 1 pixel. The intensity of the resulting pixel depends on how many pixels are set in the matrix.

#### Example

Creates a Memory Device and selects it for output. A large font is then set and a text is written to the Memory Device:

```
GUI_MEMDEV_Handle hMem = GUI_MEMDEV_Create(0,0,60,32);
GUI_MEMDEV_Select(hMem);
GUI_SetFont(&GUI_Font32B_ASCII);
GUI_DispString("Text");
GUI_MEMDEV_CopyToLCDAA(hMem);
```

#### Screenshot of above example



### 6.6.11.1.6 GUI\_MEMDEV\_CopyToLCDAt()

#### Description

Copies the contents of a Memory Device to the LCD at the given position.

#### Prototype

```
void GUI_MEMDEV_CopyToLCDAt(GUI_MEMDEV_Handle hMem,  
                             int x,  
                             int y);
```

#### Parameters

| Parameter            | Description                |
|----------------------|----------------------------|
| <a href="#">hMem</a> | Handle to a Memory Device. |
| <a href="#">x</a>    | Position in X              |
| <a href="#">y</a>    | Position in Y              |

### 6.6.11.1.7 GUI\_MEMDEV\_Create()

#### Description

Creates a Memory Device.

#### Prototype

```
GUI_MEMDEV_Handle GUI_MEMDEV_Create(int x0,  
                                     int y0,  
                                     int xSize,  
                                     int ySize);
```

#### Parameters

| Parameter | Description                      |
|-----------|----------------------------------|
| x0        | X-position of the Memory Device. |
| y0        | Y-position of the Memory Device. |
| xSize     | X-size of the Memory Device.     |
| ySize     | Y-size of the Memory Device.     |

#### Return value

Handle of the created Memory Device. If the routine fails the return value is 0.

### 6.6.11.1.8 GUI\_MEMDEV\_CreateCopy()

#### Description

This function creates a copy from a memory device.

#### Prototype

```
GUI_MEMDEV_Handle GUI_MEMDEV_CreateCopy(GUI_MEMDEV_Handle hMemSrc);
```

#### Parameters

| Parameter               | Description                               |
|-------------------------|---|
| <a href="#">hMemSrc</a> | Handle of the memory device to be copied. |

#### Return value

The return value is a handle of a memory device containing the copy of [hMemSrc](#). If there is not enough memory to create a memory device as copy, this function returns 0.



### 6.6.11.1.9 GUI\_MEMDEV\_CreateEx()

#### Description

Creates a Memory Device.

#### Prototype

```
GUI_MEMDEV_Handle GUI_MEMDEV_CreateEx(int x0,
                                       int y0,
                                       int xSize,
                                       int ySize,
                                       int Flags);
```

#### Parameters

| Parameter          | Description  |
|--------------------|--|
| <code>x0</code>    | x-position of the Memory Device.   |
| <code>y0</code>    | y-position of the Memory Device.   |
| <code>xSize</code> | x-size of the Memory Device.   |
| <code>ySize</code> | y-size of the Memory Device.   |
| <code>Flags</code> | A list of permitted values can be found under <i>Memory device flags</i> on page 2714. |

#### Return value

Handle of the created Memory Device. If the routine fails the return value is 0.

### 6.6.11.1.10 GUI\_MEMDEV\_CreateFixed()

#### Description

Creates a Memory Device with dedicated color depth color conversion.

#### Prototype

```
GUI_MEMDEV_Handle GUI_MEMDEV_CreateFixed(    int          x0,
                                             int          y0,
                                             int          xSize,
                                             int          ySize,
                                             int          Flags,
                                             const GUI_DEVICE_API * pDeviceAPI,
                                             const LCD_API_COLOR_CONV * pColorConvAPI);
```

#### Parameters

| Parameter                  | Description   |
|----------------------------|---|
| <code>x0</code>            | x-position of the Memory Device.  |
| <code>y0</code>            | y-position of the Memory Device.  |
| <code>xSize</code>         | x-size of the Memory Device.  |
| <code>ySize</code>         | y-size of the Memory Device.  |
| <code>Flags</code>         | A list of permitted values can be found under <i>Memory device flags</i> on page 2714.                          |
| <code>pMemDevAPI</code>    | A list of permitted color depths can be found under <i>Memory device color depths</i> on page 2713.             |
| <code>pColorConvAPI</code> | A list of permitted color conversion routines can be found under <i>Color conversion routines</i> on page 2711. |

#### Return value

Handle of the created Memory Device. If the routine fails the return value is 0.

#### Additional information

This function can be used if a Memory Device with a specified color conversion should be created. This could make sense if for example some items should be printed on a printer device. The `Sample` folder contains the code example `MEMDEV_Printing.c` which shows how to use the function to print something in 1bpp color conversion mode.

#### Example

The following example shows how to create a Memory Device with 1bpp color depth:

```
GUI_MEMDEV_Handle hMem;
hMem = GUI_MEMDEV_CreateFixed(0, 0, 128, 128, 0,
                             GUI_MEMDEV_APILIST_1, // Used API list
                             GUI_COLOR_CONV_1);
// Black/white color conversion
GUI_MEMDEV_Select(hMem);
```

### 6.6.11.1.11 GUI\_MEMDEV\_CreateFixed32()

#### Description

Creates a Memory Device with a color depth of 32bpp and GUICC\_8888 color conversion.

#### Prototype

```
GUI_MEMDEV_Handle GUI_MEMDEV_CreateFixed32(int x0,  
                                           int y0,  
                                           int xSize,  
                                           int ySize);
```

#### Parameters

| Parameter             | Description                      |
|-----------------------|----------------------------------|
| <a href="#">x0</a>    | x-position of the Memory Device. |
| <a href="#">y0</a>    | y-position of the Memory Device. |
| <a href="#">xSize</a> | x-size of the Memory Device.     |
| <a href="#">ySize</a> | y-size of the Memory Device.     |

#### Return value

Handle to the created Memory Device. If the routine fails the return value is 0.

#### Additional information

This function makes it more easy to create a 32 bpp memory device which is often required.

### 6.6.11.1.12 GUI\_MEMDEV\_Delete()

#### Description

Deletes a Memory Device.

#### Prototype

```
void GUI_MEMDEV_Delete(GUI_MEMDEV_Handle hMemDev);
```

#### Parameters

| Parameter            | Description  |
|----------------------|--|
| <a href="#">hMem</a> | Handle to the Memory Device which has to be deleted. |

### 6.6.11.1.13 GUI\_MEMDEV\_DrawPerspectiveX()

#### Description

Draws the given Memory Device perspectively distorted into the currently selected device.

#### Prototype

```
void GUI_MEMDEV_DrawPerspectiveX(GUI_MEMDEV_Handle hMem,
                                int x,
                                int y,
                                int h0,
                                int h1,
                                int dx,
                                int dy);
```

#### Parameters

| Parameter         | Description   |
|-------------------|---|
| <code>hMem</code> | Handle to source Memory Device with the image to be drawn.  |
| <code>x</code>    | Horizontal start position in pixels.  |
| <code>y</code>    | Vertical start position in pixels.  |
| <code>h0</code>   | Height of the leftmost edge of the image to be drawn.   |
| <code>h1</code>   | Height of the rightmost edge of the image to be drawn.  |
| <code>dx</code>   | Width of the image to be drawn.   |
| <code>dy</code>   | Position in <code>y</code> from the topmost pixel at the right relative to the topmost pixel at the left. |

The picture below explains the parameters more detailed:

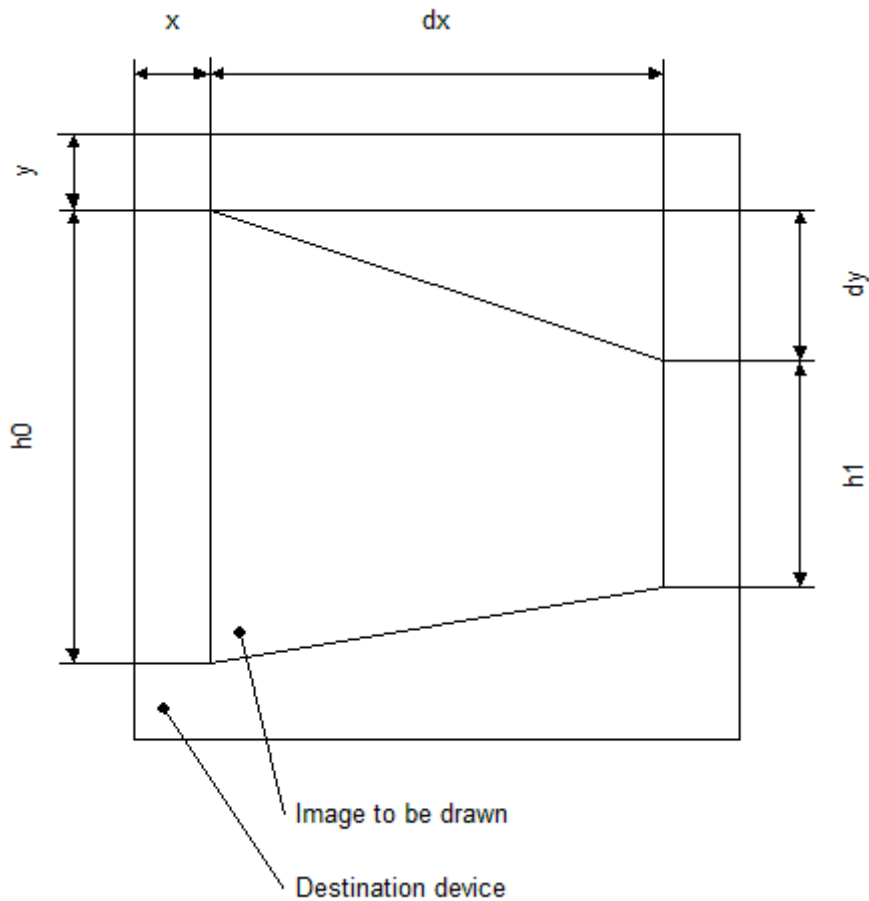

## Additional information

The function draws the contents of the given Memory Device into the currently selected device. The origin of the source device should be (0, 0). Size and distortion of the new image is defined by the parameters `dx`, `dy`, `h0` and `h1`. Note that the function currently only works with Memory Devices with 32-bpp color depth and a system color depth of 32 bpp.

## Example

The following example shows how to use the function:

```
GUI_MEMDEV_Handle hMem0, hMem1, hMem2;
hMem0 = GUI_MEMDEV_CreateFixed(0, 0, 150, 150, GUI_MEMDEV_NOTRANS,
                               GUI_MEMDEV_APILIST_32,
                               GUI_COLOR_CONV_888);
hMem1 = GUI_MEMDEV_CreateFixed(0, 0, 75, 150, GUI_MEMDEV_HASTRANS,
                               GUI_MEMDEV_APILIST_32,
                               GUI_COLOR_CONV_888);
hMem2 = GUI_MEMDEV_CreateFixed(0, 0, 75, 150, GUI_MEMDEV_HASTRANS,
                               GUI_MEMDEV_APILIST_32,
                               GUI_COLOR_CONV_888);

GUI_MEMDEV_Select(hMem0);
GUI_JPEG_Draw(_aJPEG, sizeof(_aJPEG), 0, 0);
GUI_MEMDEV_Select(hMem1);
GUI_MEMDEV_DrawPerspectiveX(hMem0, 0, 0, 150, 110, 75, 20);
GUI_MEMDEV_Select(hMem2);
GUI_MEMDEV_DrawPerspectiveX(hMem0, 0, 20, 110, 150, 75, -20);
GUI_MEMDEV_CopyToLCDAt(hMem0, 0, 10);
GUI_MEMDEV_CopyToLCDAt(hMem1, 160, 10);
GUI_MEMDEV_CopyToLCDAt(hMem2, 245, 10);
```

## Screenshot of above example

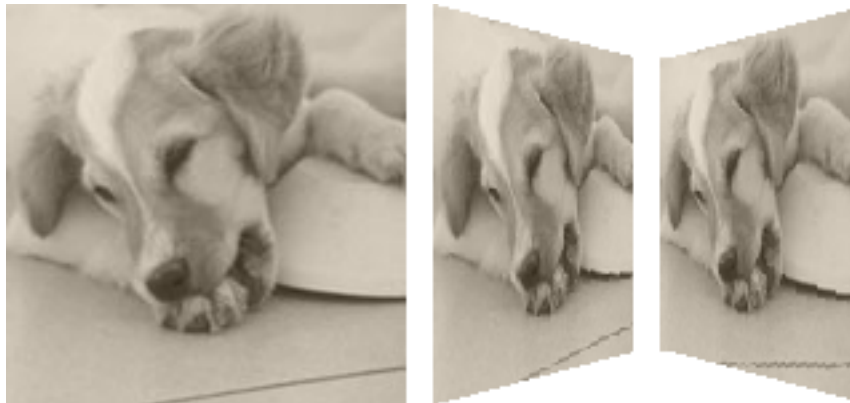

#### 6.6.11.1.14 GUI\_MEMDEV\_GetBitsPerPixel()

##### Description

Returns the color depth of given Memory Device.

##### Prototype

```
int GUI_MEMDEV_GetBitsPerPixel(GUI_MEMDEV_Handle hMemDev);
```

##### Parameters

| Parameter               | Description   |
|-------------------------|---|
| <a href="#">hMemDev</a> | Handle to the Memory Device which color depths should be retrieved. |

##### Return value

Bits per pixel of the given Memory Device.

### 6.6.11.1.15 GUI\_MEMDEV\_GetDataPtr()

#### Description

Returns a pointer to the data area (image area) of a Memory Device. This data area can then be manipulated without the use of GUI functions; it can for example be used as output buffer for a JPEG or video decompression routine.

#### Prototype

```
void *GUI_MEMDEV_GetDataPtr(GUI_MEMDEV_Handle hMem);
```

#### Parameters

| Parameter | Description              |
|-----------|--------------------------|
| hMem      | Handle to Memory Device. |

#### Return value

Data pointer to the Device's data area. NULL on error.

#### Additional information

The device data is stored from the returned address onwards. An application modifying this data has to take extreme caution that it does not overwrite memory outside of this data area.

#### Note

Allocating dynamic memory could cause invalid data pointers!

It should be kept sure, that no memory is allocated during the pointer is used. Allocating memory could cause invalid pointers because of memory cleaning operations.

#### Organization of the data area

The pixels are stored in the mode "native" to the display (or layer) for which they are intended. For layers with 8 bpp or less, 8 bits (1 byte) are used per pixel; for layers with more than 8 and less or equal 16 bpp, a 16 bit value (U16) is used for one pixel.

The memory is organized in reading order which means: First byte (or U16), stored at the start address, represents the color index of the pixel in the upper left corner ( $y=0, x=0$ ); the next pixel, stored right after the first one, is the one to the left at ( $y=0, x=1$ ). (Unless the Memory Device area is only 1 pixel wide).

The next line is stored right after the first line in memory, without any kind of padding. Endian mode is irrelevant, it is assumed that 16 bit units are accessed as 16 bit units and not as 2 separate bytes.

The data area is comprised of  $xSize * ySize$  pixels, so  $xSize * ySize$  bytes for 8bpp or lower Memory Devices,  $2 * xSize * ySize$  bytes (accessed as  $xSize * ySize$  units of 16 bits) for 16 bpp Memory Devices.



#### 6.6.11.1.16 GUI\_MEMDEV\_GetSelMemdev()

##### Description

Returns a handle to the currently selected Memory Device.

##### Prototype

```
GUI_MEMDEV_Handle GUI_MEMDEV_GetSelMemdev(void);
```

##### Return value

Handle of the currently selected Memory Device. 0 if no device is selected.

### 6.6.11.1.17 GUI\_MEMDEV\_GetXSize()

#### Description

Returns the X-size (width) of a Memory Device.

#### Prototype

```
int GUI_MEMDEV_GetXSize(GUI_MEMDEV_Handle hMem);
```

#### Parameters

| Parameter            | Description              |
|----------------------|--------------------------|
| <a href="#">hMem</a> | Handle to Memory Device. |

#### Return value

X-size of Memory Device.

### 6.6.11.1.18 GUI\_MEMDEV\_GetYSize()

#### Description

Returns the Y-size (height) of a Memory Device in pixels.

#### Prototype

```
int GUI_MEMDEV_GetYSize(GUI_MEMDEV_Handle hMem);
```

#### Parameters

| Parameter            | Description              |
|----------------------|--------------------------|
| <a href="#">hMem</a> | Handle to Memory Device. |

#### Return value

Y-size of Memory Device.

### 6.6.11.1.19 GUI\_MEMDEV\_MarkDirty()

#### Description

Marks a rectangle area as dirty.

#### Prototype

```
void GUI_MEMDEV_MarkDirty(GUI_MEMDEV_Handle hMem,  
                           int x0,  
                           int y0,  
                           int x1,  
                           int y1);
```

#### Parameters

| Parameter            | Description                             |
|----------------------|---|
| <a href="#">hMem</a> | Handle to Memory Device.                |
| <a href="#">x0</a>   | x-coordinate of the upper left corner.  |
| <a href="#">y0</a>   | y-coordinate of the upper left corner.  |
| <a href="#">x1</a>   | x-coordinate of the lower right corner. |
| <a href="#">y1</a>   | y-coordinate of the lower right corner. |

### 6.6.11.1.20 GUI\_MEMDEV\_PunchOutDevice()

#### Description

Punches out a shape of a Memory Device defined by a 8bpp mask Memory Device.

The mask device must consist of 8bpp index values which define the intensity of the pixels to be used:

- Intensity 0 means 100% transparent.
- Intensity 255 means 100% opaque.

Intensity values between 0 and 255 mean semi transparency. The behavior of the function depends on the draw mode:

- GUI\_DM\_TRANS - Pixel becomes semi transparent
- other value - Pixel is mixed with the current background color

The punching operation will be done in the given device hMemData.

#### Prototype

```
int GUI_MEMDEV_PunchOutDevice(GUI_MEMDEV_Handle hMemData,
                              GUI_MEMDEV_Handle hMemMask);
```

#### Parameters

| Parameter | Description  |
|-----------|--|
| hMemData  | Memory Device which should be punched out. Must be a 32 bit Memory Device. |
| hMemMask  | Handle to the Memory Device mask, which contains the intensity values.     |

#### Return value

- 0 on success
- 1 on error.

#### Example

```
#include "GUI.h"
/*****
 *
 *      MainTask
 */
void MainTask(void) {
    GUI_MEMDEV_Handle hMemData;
    GUI_MEMDEV_Handle hMemMask;
    GUI_RECT          Rect;
    GUI_Init();
    //
    // Background
    //
    GUI_SetBkColor(GUI_DARKBLUE);
    GUI_Clear();
    GUI_DrawGradientV(0, 0, 99, 49, GUI_DARKGRAY, GUI_DARKBLUE);
    GUI_SetColor(GUI_WHITE);
    //
    // Mask device
    //
    hMemMask = GUI_MEMDEV_CreateFixed(0, 0, 99, 49, GUI_MEMDEV_NOTRANS,
                                     GUI_MEMDEV_APILIST_8, GUICC_8);

    GUI_SetDrawMode(GUI_DM_TRANS);
    GUI_MEMDEV_Select(hMemMask);
    GUI_SetBkColor(GUI_BLACK);
    GUI_Clear();
    GUI_AA_FillCircle(49, 24, 20);
```

```

GUI_SetPenSize(8);
GUI_DrawLine(0, 0, 99, 49);
//
// Data Device
//
hMemData = GUI_MEMDEV_CreateFixed32(0, 0, 99, 49);
GUI_MEMDEV_Select(hMemData);
GUI_SetBkColor(GUI_LIGHTGRAY);
GUI_Clear();
Rect.x0 = 6;
Rect.y0 = 0;
Rect.x1 = 99;
Rect.y1 = 49;
GUI_SetColor(GUI_DARKGRAY);
GUI_DispStringInRectEx("Punch\nme\nout!", &Rect,
                       GUI_TA_HCENTER | GUI_TA_VCENTER, 20, GUI_ROTATE_0);
//
// Result
//
GUI_MEMDEV_Select(0);
GUI_MEMDEV_PunchOutDevice(hMemData, hMemMask);
GUI_MEMDEV_Write(hMemData);
while (1) {
    GUI_Delay(100);
}
}

```

## Screenshots



### 6.6.11.1.21 GUI\_MEMDEV\_ReduceYSize()

#### Description

Reduces the Y-size of a Memory Device.

#### Prototype

```
void GUI_MEMDEV_ReduceYSize(GUI_MEMDEV_Handle hMem,  
                             int YSize);
```

#### Parameters

| Parameter          | Description                      |
|--------------------|----------------------------------|
| <code>hMem</code>  | Handle to Memory Device.         |
| <code>YSize</code> | New Y-size of the Memory Device. |

#### Additional information

Changing the size of the Memory Device is more efficient than deleting and then recreating it.

**6.6.11.1.22 GUI\_MEMDEV\_Rotate()****6.6.11.1.23 GUI\_MEMDEV\_RotateAlpha()****6.6.11.1.24 GUI\_MEMDEV\_RotateHQ()****6.6.11.1.25 GUI\_MEMDEV\_RotateHQAlpha()****6.6.11.1.26 GUI\_MEMDEV\_RotateHQHR()****6.6.11.1.27 GUI\_MEMDEV\_RotateHQT()****6.6.11.1.28 GUI\_MEMDEV\_RotateHR()****General Description**

The functions rotate and scale the given source Memory Device. The source device will be rotated and scaled around its center and then shifted by the given amount of pixels. The result is saved into the given destination Memory Device. All these functions have similar postfixes containing the sequences 'HQ', 'HQT', 'HR' and 'Alpha' which are explained in the following:

**Description 'HQ'**

HQ stands for "High Quality". The functions which are named HQ use a more complex algorithm for calculating the destination pixel data. The HQ-algorithm can be used to achieve accurate results. The functions without the HQ addition use the 'nearest neighbor' method which is fast, but less accurate.

**Description 'HQT'**

HQT stands for "High Quality Transparency". The HQT algorithm improves the performance when rotating Memory Devices containing completely transparent pixels. The more completely transparent pixels the Memory Device contains, the more significant the performance boost gets. This function is still a HQ function and therefore produces results of the same accuracy.

**Description 'HR'**

HR stands for "High Resolution". The functions named HR use a precision of 8 sub-pixels. This makes it possible to display a Memory Device much more precisely on the screen.

**Description 'Alpha'**

The 'Alpha' functions allow to use an alpha value for blending in the source device into the destination device. A value between 0 and 255 can be used, where 0 means completely visible and 255 completely transparent. Of course alpha values of the source device will be considered.

**Prototypes**

```
void GUI_MEMDEV_Rotate (GUI_MEMDEV_Handle hSrc,
                       GUI_MEMDEV_Handle hDst,
                       int dx,
                       int dy,
                       int a,
                       int Mag);
```

```
void GUI_MEMDEV_RotateHQT (GUI_MEMDEV_Handle hSrc,
                           GUI_MEMDEV_Handle hDst,
                           int dx,
                           int dy,
                           int a,
                           int Mag);
```



```
void GUI_MEMDEV_RotateHQ (GUI_MEMDEV_Handle hSrc,
                          GUI_MEMDEV_Handle hDst,
                          int dx,
                          int dy,
                          int a,
                          int Mag);
```

## Parameters

| Parameter            | Description                                       |
|----------------------|---|
| <a href="#">hSrc</a> | Handle of Memory Device to be rotated and scaled. |
| <a href="#">hDst</a> | Handle of destination device.                     |
| <a href="#">dx</a>   | Distance in pixels for shifting the image in X.   |
| <a href="#">dy</a>   | Distance in pixels for shifting the image in Y.   |
| <a href="#">a</a>    | Angle to be used for rotation in degrees * 1000.  |
| <a href="#">Mag</a>  | Magnification factor * 1000.                      |

## Prototypes Alpha

```
void GUI_MEMDEV_RotateAlpha (GUI_MEMDEV_Handle hSrc,
                             GUI_MEMDEV_Handle hDst,
                             int dx,
                             int dy,
                             int a,
                             int Mag,
                             U8 Alpha);
```

```
void GUI_MEMDEV_RotateHQAlpha(GUI_MEMDEV_Handle hSrc,
                              GUI_MEMDEV_Handle hDst,
                              int dx,
                              int dy,
                              int a,
                              int Mag,
                              U8 Alpha);
```

## Parameters Alpha

| Parameter             | Description  |
|-----------------------|--|
| <a href="#">hSrc</a>  | Handle of Memory Device to be rotated and scaled.  |
| <a href="#">hDst</a>  | Handle of destination device.                      |
| <a href="#">dx</a>    | Distance in pixels for shifting the image in X.    |
| <a href="#">dy</a>    | Distance in pixels for shifting the image in Y.    |
| <a href="#">a</a>     | Angle to be used for rotation in degrees * 1000.   |
| <a href="#">Mag</a>   | Magnification factor * 1000.                       |
| <a href="#">Alpha</a> | Alpha value to be used for blending in the device. |

## Prototypes HR

```
void GUI_MEMDEV_RotateHQHR(GUI_MEMDEV_Handle hSrc,
                            GUI_MEMDEV_Handle hDst,
                            I32 dx,
                            I32 dy,
                            int a,
                            int Mag);
```

```
void GUI_MEMDEV_RotateHR (GUI_MEMDEV_Handle hSrc,
                          GUI_MEMDEV_Handle hDst,
                          I32 dx,
                          I32 dy,
                          int a,
```

`int` `Mag` ;

**Parameters HR**

| Parameter         | Description                                       |
|-------------------|---|
| <code>hSrc</code> | Handle of Memory Device to be rotated and scaled. |
| <code>hDst</code> | Handle of destination device.                     |
| <code>dx</code>   | Distance in pixels for shifting the image in X.   |
| <code>dy</code>   | Distance in pixels for shifting the image in Y.   |
| <code>a</code>    | Angle to be used for rotation in degrees * 1000.  |
| <code>Mag</code>  | Magnification factor * 1000.                      |

The following picture gives a more detailed impression of the parameters:

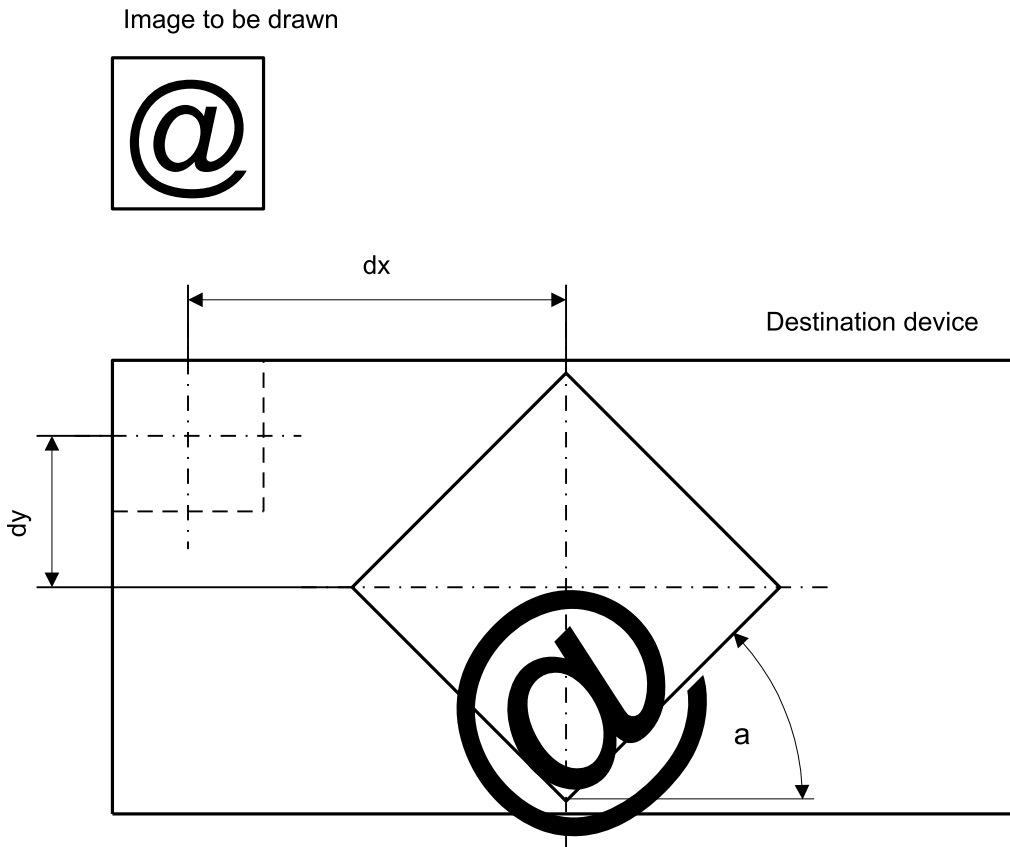

**Additional information**

Both Memory Devices, source and destination, need to be created using a color depth of 32bpp. Further `GUI_MEMDEV_NOTRANS` should be used as Flags parameter when creating the devices. If it is intended to preserve transparency, the according areas in both Memory Devices need to be filled with transparency before calling a rotate function. The Sample folder contains the `MEMDEV_ZoomAndRotate.c` application which shows in detail how the function can be used.

**Performance advantage of GUI\_MEMDEV\_RotateHQT()**

The following table shows an approximation of the performance in comparison to `GUI_MEMDEV_RotateHQ()` in dependence of the percentage of transparent pixels:

| Percentage of transparent pixels | Performance advantage |
|----------------------------------|-----------------------|
| 0%                               | - 3%                  |
| 10%                              | 0%                    |

| Percentage of transparent pixels | Performance advantage |
|----------------------------------|-----------------------|
| 50%                              | + 21%                 |
| 90%                              | + 74%                 |

## Example

```

GUI_MEMDEV_Handle hMemSource;
GUI_MEMDEV_Handle hMemDest;
GUI_RECT RectSource = {0, 0, 69, 39};
GUI_RECT RectDest  = {0, 0, 79, 79};
hMemSource = GUI_MEMDEV_CreateFixed(RectSource.x0, RectSource.y0,
                                   RectSource.x1 - RectSource.x0 + 1,
                                   RectSource.y1 - RectSource.y0 + 1,
                                   GUI_MEMDEV_NOTRANS,
                                   GUI_MEMDEV_APILIST_32, GUI_COLOR_CONV_888);
hMemDest  = GUI_MEMDEV_CreateFixed(RectDest.x0,  RectDest.y0,
                                   RectDest.x1  - RectDest.x0  + 1,
                                   RectDest.y1  - RectDest.y0  + 1,
                                   GUI_MEMDEV_NOTRANS,
                                   GUI_MEMDEV_APILIST_32, GUI_COLOR_CONV_888);

GUI_MEMDEV_Select(hMemSource);
GUI_DrawGradientV(RectSource.x0, RectSource.y0,
                  RectSource.x1, RectSource.y1,
                  GUI_WHITE, GUI_DARKGREEN);
GUI_SetColor(GUI_BLUE);
GUI_SetFont(&GUI_Font20B_ASCII);
GUI_SetTextMode(GUI_TM_TRANS);
GUI_DispStringInRect("emWin", &RectSource, GUI_TA_HCENTER | GUI_TA_VCENTER);
GUI_DrawRect(0, 0, RectSource.x1, RectSource.y1);
GUI_MEMDEV_Select(hMemDest);
GUI_Clear();
GUI_MEMDEV_Select(0);
GUI_MEMDEV_RotateHQ(hMemSource, hMemDest,
                    (RectDest.x1 - RectSource.x1) / 2,
                    (RectDest.y1 - RectSource.y1) / 2,
                    30 * 1000,
                    1000);
GUI_MEMDEV_CopyToLCDAt(hMemSource, 10, (RectDest.y1 - RectSource.y1) / 2);
GUI_MEMDEV_CopyToLCDAt(hMemDest, 100, 0);

```

### Screenshot of the above example using GUI\_MEMDEV\_Rotate()



### Screenshot of the above example using GUI\_MEMDEV\_RotateHQ()



### Screenshot of the above example using GUI\_MEMDEV\_RotateHQHR()

This screenshot shows the 8 steps to move an anti-aliased corner one pixel to the right using sub-pixels.

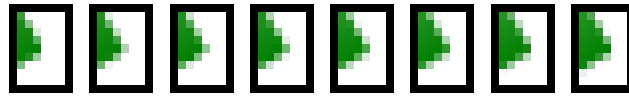

### 6.6.11.1.29 GUI\_MEMDEV\_Select()

#### Description

Activates a Memory Device (or activates LCD if handle is 0).

#### Prototype

```
GUI_MEMDEV_Handle GUI_MEMDEV_Select(GUI_MEMDEV_Handle hMemDev);
```

#### Parameters

| Parameter            | Description              |
|----------------------|--------------------------|
| <a href="#">hMem</a> | Handle to Memory Device. |

#### Return value

Previously selected device. 0, if the display was selected.

### 6.6.11.1.30 GUI\_MEMDEV\_SerializeBMP()

#### Description

Creates a BMP file from the given Memory Device.

#### Prototype

```
void GUI_MEMDEV_SerializeBMP(GUI_MEMDEV_Handle    hDev,
                             GUI_CALLBACK_VOID_U8_P * pfSerialize,
                             void                * p);
```

#### Parameters

| Parameter                | Description  |
|--------------------------|--|
| <code>hDev</code>        | Handle to Memory Device.   |
| <code>pfSerialize</code> | Pointer to a user defined serialization function. See prototype below. |
| <code>p</code>           | Pointer to user defined data passed to the serialization function.     |

#### Additional information

To create a BMP file the color depth of the given Memory Device is used. In case it is 32bpp the resulting BMP file will consist of valid alpha data which is recognized by the Bitmap Converter.

An example for serialization can be found in the description of `GUI_BMP_Serialize()`.

#### Prototype of GUI\_CALLBACK\_VOID\_U8\_P

```
void GUI_CALLBACK_VOID_U8_P(U8    Data,
                             void * p);
```

### 6.6.11.1.31 GUI\_MEMDEV\_SerializeExBMP()

#### Description

Creates a BMP file from a given rectangular area of a memory device.

#### Prototype

```
void GUI_MEMDEV_SerializeExBMP(GUI_MEMDEV_Handle    hDev,
                               GUI_CALLBACK_VOID_U8_P * pfSerialize,
                               void                * p,
                               int                 xPos,
                               int                 yPos,
                               int                 xSize,
                               int                 ySize);
```

#### Parameters

| Parameter                | Description  |
|--------------------------|--|
| <code>hDev</code>        | Handle to Memory Device.   |
| <code>pfSerialize</code> | Pointer to a user defined serialization function. See prototype below. |
| <code>p</code>           | Pointer to user defined data passed to the serialization function.     |
| <code>xPos</code>        | X-position of upper left position of the rectangular area.             |
| <code>yPos</code>        | Y-position of upper left position of the rectangular area.             |
| <code>xSize</code>       | X-size of the rectangular area.  |
| <code>ySize</code>       | Y-size of the rectangular area.  |

#### Additional information

An example for serialization can be found in the description of `GUI_BMP_Serialize()`.

#### Prototype of GUI\_CALLBACK\_VOID\_U8\_P

```
void GUI_CALLBACK_VOID_U8_P(U8    Data,
                           void * p);
```

### 6.6.11.1.32 GUI\_MEMDEV\_SetOrg()

#### Description

Changes the origin of the Memory Device on the LCD.

#### Prototype

```
void GUI_MEMDEV_SetOrg(GUI_MEMDEV_Handle hMem,  
                       int x0,  
                       int y0);
```

#### Parameters

| Parameter            | Description                                    |
|----------------------|--|
| <a href="#">hMem</a> | Handle to Memory Device.                       |
| <a href="#">x0</a>   | Horizontal position (of the upper left pixel). |
| <a href="#">y0</a>   | Vertical position (of the upper left pixel).   |

#### Additional information

This routine can be helpful when the same device is used for different areas of the screen or when the contents of the Memory Device are to be copied into different areas. Changing the origin of the Memory Device is more efficient than deleting and then recreating it.



### 6.6.11.1.33 GUI\_MEMDEV\_Write()

#### Description

Writes the content of the given Memory Device into the currently selected device.

#### Prototype

```
void GUI_MEMDEV_Write(GUI_MEMDEV_Handle hMem);
```

#### Parameters

| Parameter            | Description              |
|----------------------|--------------------------|
| <a href="#">hMem</a> | Handle to Memory Device. |

#### Additional information

In case of writing a 32 bpp memory device with alpha channel the alpha values will be considered for mixing the content of the given memory device with the content of the currently selected device.

### 6.6.11.1.34 GUI\_MEMDEV\_WriteAlpha()

#### Description

Writes the content of the given Memory Device into the currently selected device using alpha blending.

#### Prototype

```
void GUI_MEMDEV_WriteAlpha(GUI_MEMDEV_Handle hMem,  
                           int Alpha);
```

#### Parameters

| Parameter             | Description                                    |
|-----------------------|--|
| <a href="#">hMem</a>  | Handle to Memory Device.                       |
| <a href="#">Alpha</a> | <a href="#">Alpha</a> blending factor, 0 - 255 |

#### Additional information

[Alpha](#) blending means mixing 2 colors with a given intensity. This function makes it possible to write semi-transparent from one Memory Device into an other Memory Device. The [Alpha](#)-parameter specifies the intensity used when writing to the currently selected device. In case of writing a 32 bpp memory device with alpha channel the alpha values will also be considered.

### 6.6.11.1.35 GUI\_MEMDEV\_WriteAlphaAt()

#### Description

Writes the content of the given Memory Device into the currently selected device at the specified position using alpha blending.

#### Prototype

```
void GUI_MEMDEV_WriteAlphaAt(GUI_MEMDEV_Handle hMem,  
                             int Alpha,  
                             int x,  
                             int y);
```

#### Parameters

| Parameter             | Description                                    |
|-----------------------|--|
| <a href="#">hMem</a>  | Handle to Memory Device.                       |
| <a href="#">Alpha</a> | <a href="#">Alpha</a> blending factor, 0 - 255 |
| <a href="#">x</a>     | Position in X                                  |
| <a href="#">y</a>     | Position in Y                                  |

#### Additional information

See [GUI\\_MEMDEV\\_WriteAlpha\(\)](#).

### 6.6.11.1.36 GUI\_MEMDEV\_WriteAt()

#### Description

Writes the content of the given Memory Device into the currently selected device at the specified position.

#### Prototype

```
void GUI_MEMDEV_WriteAt(GUI_MEMDEV_Handle hMem,  
                        int x,  
                        int y);
```

#### Parameters

| Parameter         | Description              |
|-------------------|--------------------------|
| <code>hMem</code> | Handle to Memory Device. |
| <code>x</code>    | Position in X            |
| <code>y</code>    | Position in Y            |

#### Additional information

(See *GUI\_MEMDEV\_Write* on page 2669)

### 6.6.11.1.37 GUI\_MEMDEV\_WriteEx()

#### Description

Writes the content of the given Memory Device into the currently selected device at position (0, 0) using alpha blending and scaling.

#### Prototype

```
void GUI_MEMDEV_WriteEx(GUI_MEMDEV_Handle hMem,  
                        int                xMag,  
                        int                yMag,  
                        int                Alpha);
```

#### Parameters

| Parameter             | Description                                     |
|-----------------------|---|
| <a href="#">hMem</a>  | Handle to Memory Device.                        |
| <a href="#">xMag</a>  | Scaling factor for X-axis * 1000.               |
| <a href="#">yMag</a>  | Scaling factor for Y-axis * 1000.               |
| <a href="#">Alpha</a> | <a href="#">Alpha</a> blending factor, 0 - 255. |

#### Additional information

A negative scaling factor mirrors the output. Also refer to `GUI_MEMDEV_WriteExAt()` below.

### 6.6.11.1.38 GUI\_MEMDEV\_WriteExAt()

#### Description

Writes the content of the given Memory Device into the currently selected device at the specified position using alpha blending and scaling.

#### Prototype

```
void GUI_MEMDEV_WriteExAt(GUI_MEMDEV_Handle hMem,
                          int                x,
                          int                y,
                          int                xMag,
                          int                yMag,
                          int                Alpha);
```

#### Parameters

| Parameter          | Description                       |
|--------------------|-----------------------------------|
| <code>hMem</code>  | Handle to Memory Device.          |
| <code>x</code>     | Position in X.                    |
| <code>y</code>     | Position in Y.                    |
| <code>xMag</code>  | Scaling factor for X-axis * 1000. |
| <code>yMag</code>  | Scaling factor for Y-axis * 1000. |
| <code>Alpha</code> | Alpha blending factor, 0 - 255.   |

#### Additional information

A negative scaling factor mirrors the output.

#### Example

The following example creates 2 Memory Devices: `hMem0` (40x10) and `hMem1` (80x20). A small white text is drawn at the upper left position of `hMem0` and `hMem1`. Then the function `GUI_MEMDEV_WriteEx()` writes the content of `hMem0` to `hMem1` using mirroring and magnifying:

```
GUI_MEMDEV_Handle hMem0, hMem1;
GUI_Init();
hMem0 = GUI_MEMDEV_Create(0, 0, 40, 10);
hMem1 = GUI_MEMDEV_Create(0, 0, 80, 20);
GUI_MEMDEV_Select(hMem0);
GUI_SetTextMode(GUI_TM_TRANS);
GUI_DispString("Text");
GUI_MEMDEV_Select(hMem1);
GUI_SetBkColor(GUI_RED);
GUI_Clear();
GUI_DispStringAt("Text", 0, 0);
GUI_MEMDEV_WriteExAt(hMem0, 0, 0, -2000, -2000, 160);
GUI_MEMDEV_CopyToLCD(hMem1);
```

#### Screenshot of the above example



### 6.6.11.1.39 GUI\_MEMDEV\_WriteOpaque()

#### Description

Writes the content of the given Memory Device into the currently selected device.

#### Prototype

```
void GUI_MEMDEV_WriteOpaque(GUI_MEMDEV_Handle hMem);
```

#### Parameters

| Parameter            | Description              |
|----------------------|--------------------------|
| <a href="#">hMem</a> | Handle to Memory Device. |

#### Additional information

In case of writing a 32 bpp memory device with alpha channel the alpha values will not be changed and copied as they are. Although, the name implies that the memory device becomes fully opaque the alpha values will remain. The alpha values will be copied without mixing with the background.

#### 6.6.11.1.40 GUI\_MEMDEV\_WriteOpaqueAt()

##### Description

Writes the content of the given Memory Device into the currently selected device at the specified position.

##### Prototype

```
void GUI_MEMDEV_WriteOpaqueAt(GUI_MEMDEV_Handle hMem,  
                               int x,  
                               int y);
```

##### Parameters

| Parameter            | Description              |
|----------------------|--------------------------|
| <a href="#">hMem</a> | Handle to Memory Device. |

##### Additional information

In case of writing a 32 bpp memory device with alpha channel the alpha values will not be changed and copied as they are. Although, the name implies that the memory device becomes fully opaque the alpha values will remain. The alpha values will be copied without mixing with the background.



#### 6.6.11.1.41 GUI\_SelectLCD()

##### Description

Selects the LCD as target for drawing operations.

##### Prototype

```
void GUI_SelectLCD(void);
```

### 6.6.11.2 Example for using a Memory Device

The `Sample` folder contains the following example which shows how Memory Devices can be used:

- `MEMDEV_MemDev.c`

This example demonstrates the use of a Memory Device. Some items are written to a Memory Device and then copied to the display. Note that several other examples also make use of Memory Devices and may also be helpful to get familiar with them.

#### Screenshot of above example

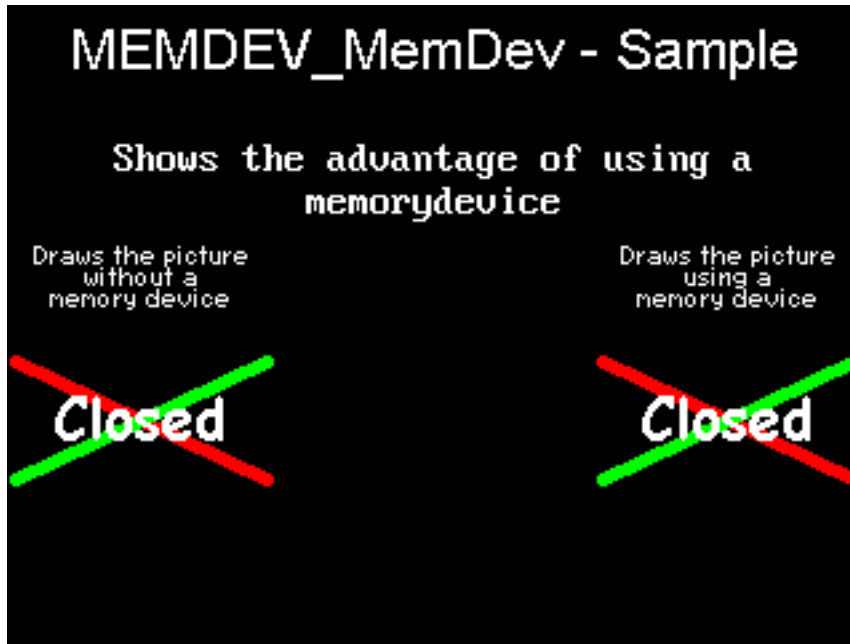

### 6.6.11.3 Banding Memory Device

A Memory Device is first filled by executing the specified drawing functions. After filling the device, the contents are drawn to the LCD. There may be not enough memory available to store the complete output area at once, depending on your configuration. A banding Memory Device divides the drawing area into bands, in which each band covers as many lines as possible with the currently available memory.

#### 6.6.11.3.1 GUI\_MEMDEV\_Draw()

##### Description

Drawing function to avoid flickering.

##### Prototype

```
int GUI_MEMDEV_Draw(GUI_RECT          * pRect,
                   GUI_CALLBACK_VOID_P * pfDraw,
                   void                * pData,
                   int                 NumLines,
                   int                 Flags);
```

##### Parameters

| Parameter                | Description   |
|--------------------------|---|
| <a href="#">pRect</a>    | Pointer to a GUI_RECT structure for the used LCD area.  |
| <a href="#">pfDraw</a>   | Pointer to a callback function for executing the drawing.   |
| <a href="#">pData</a>    | Pointer to a data structure used as parameter for the callback function.  |
| <a href="#">NumLines</a> | 0 (recommended) or number of lines for the Memory Device.   |
| <a href="#">Flags</a>    | A list of permitted values can be found under <i>Memory device flags</i> on page 2714. GUI_MEMDEV_NOTRANS is recommended. |

##### Return value

0        if successful.  
1        if the routine fails.

##### Additional information

If the parameter [NumLines](#) is 0, the number of lines in each band is calculated automatically by the function. The function then iterates over the output area band by band by moving the origin of the Memory Device.

### 6.6.11.3.2 Example for using a banding Memory Device

The `Sample` folder contains the following example which shows how the function can be used:

- `MEMDEV_Banding.c`

#### Screenshot of above example



## 6.6.11.4 Auto device object functions

Memory Devices are useful when the display must be updated to reflect the movement or changing of items, since it is important in such applications to prevent the LCD from flickering. An auto device object is based on the banding Memory Device, and may be more efficient for applications such as moving indicators, in which only a small part of the display is updated at a time.

The device automatically distinguishes which areas of the display consist of fixed objects and which areas consist of moving or changing objects that must be updated. When the drawing function is called for the first time, all items are drawn. Each further call updates only the space used by the moving or changing objects. The actual drawing operation uses the banding Memory Device, but only within the necessary space. The main advantage of using an auto device object (versus direct usage of a banding Memory Device) is that it saves computation time, since it does not keep updating the entire display.

### 6.6.11.4.1 GUI\_MEMDEV\_CreateAuto()

#### Description

Creates an auto device object.

#### Prototype

```
int GUI_MEMDEV_CreateAuto(GUI_AUTODEV * pAutoDev);
```

#### Parameters

| Parameter             | Description                      |
|-----------------------|----------------------------------|
| <code>pAutoDev</code> | Pointer to a GUI_AUTODEV object. |

#### Return value

Currently 0, reserved for later use.

#### 6.6.11.4.2 GUI\_MEMDEV\_DeleteAuto()

##### Description

Deletes an auto device object.

##### Prototype

```
void GUI_MEMDEV_DeleteAuto(GUI_AUTODEV * pAutoDev);
```

##### Parameters

| Parameter             | Description                      |
|-----------------------|----------------------------------|
| <code>pAutoDev</code> | Pointer to a GUI_AUTODEV object. |

### 6.6.11.4.3 GUI\_MEMDEV\_DrawAuto()

#### Description

Executes a specified drawing routine using a banding Memory Device.

#### Prototype

```
int GUI_MEMDEV_DrawAuto(GUI_AUTODEV      * pAutoDev,
                        GUI_AUTODEV_INFO * pAutoDevInfo,
                        GUI_CALLBACK_VOID_P * pfDraw,
                        void              * pData);
```

#### Parameters

| Parameter                 | Description   |
|---------------------------|---|
| <code>pAutoDev</code>     | Pointer to a GUI_AUTODEV object.                                      |
| <code>pAutoDevInfo</code> | Pointer to a GUI_AUTODEV_INFO object.                                 |
| <code>pfDraw</code>       | Pointer to the user-defined drawing function which is to be executed. |
| <code>pData</code>        | Pointer to a data structure passed to the drawing function.           |

#### Return value

0 if successful.  
1 if the routine fails.

#### Additional information

The GUI\_AUTODEV\_INFO structure contains the information about what items must be drawn by the user function:

```
typedef struct {
    char DrawFixed;
} GUI_AUTODEV_INFO;
```

DrawFixed is set to 1 if all items have to be drawn. It is set to 0 when only the moving or changing objects have to be drawn. We recommend the following procedure when using this feature:

```
typedef struct {
    GUI_AUTODEV_INFO AutoDevInfo; /* Information about what has to be drawn */
    /* Additional data used by the user function */
    ...
} PARAM;
static void Draw(void * p) {
    PARAM * pParam = (PARAM *)p;
    if (pParam->AutoDevInfo.DrawFixed) {
        /* Draw fixed background */
        ...
    }
    /* Draw moving objects */
    ...
    if (pParam->AutoDevInfo.DrawFixed) {
        /* Draw fixed foreground (if needed) */
        ...
    }
}
void main(void) {
    PARAM Param; /* Parameters for drawing routine */
    GUI_AUTODEV AutoDev; /* Object for banding Memory Device */
    /* Set/modify information for drawing routine */
    ...
}
```

```
GUI_MEMDEV_CreateAuto(&AutoDev); /* Create GUI_AUTODEV-object */
GUI_MEMDEV_DrawAuto(&AutoDev, /* Use GUI_AUTODEV-object for drawing */
    &Param.AutoDevInfo,
    &Draw,
    &Param);
GUI_MEMDEV_DeleteAuto(&AutoDev); /* Delete GUI_AUTODEV-object */
}
```

#### 6.6.11.4.4 Example for using an auto device object

The example `MEMDEV_AutoDev.c` demonstrates the use of an auto device object. It can be found as `MEMDEV_AutoDev.c`. A scale with a moving needle is drawn in the background and a small text is written in the foreground. The needle is drawn with the anti-aliasing feature of `emWin`. High-resolution anti-aliasing is used here to improve the appearance of the moving needle. For more information, see the chapter *Antialiasing* on page 2837.

#### Screenshot of above example

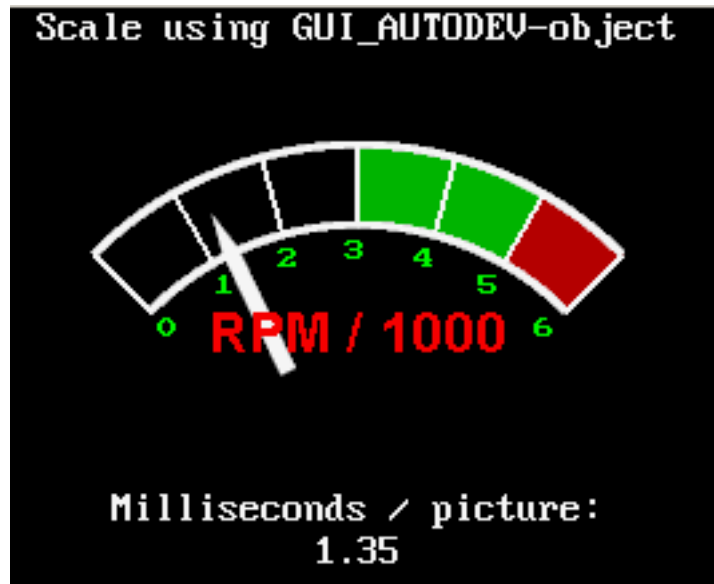



## 6.6.11.5 Measurement device object functions

Measurement devices are useful when you need to know the area used to draw something. Creating and selecting a measurement device as target for drawing operations makes it possible to retrieve the rectangle used for drawing operations.

### 6.6.11.5.1 GUI\_MEASDEV\_ClearRect()

#### Description

Call this function to clear the measurement rectangle of the given measurement device.

#### Prototype

```
void GUI_MEASDEV_ClearRect(GUI_MEASDEV_Handle hMemDev);
```

#### Parameters

| Parameter            | Description                   |
|----------------------|-------------------------------|
| <a href="#">hMem</a> | Handle to measurement device. |

### 6.6.11.5.2 GUI\_MEASDEV\_Create()

#### Description

Creates a measurement device.

#### Prototype

```
GUI_MEASDEV_Handle GUI_MEASDEV_Create(void);
```

#### Return value

The handle of the measurement device.

### 6.6.11.5.3 GUI\_MEASDEV\_Delete()

#### Description

Deletes a measurement device.

#### Prototype

```
void GUI_MEASDEV_Delete(GUI_MEASDEV_Handle hMemDev);
```

#### Parameters

| Parameter            | Description                   |
|----------------------|-------------------------------|
| <a href="#">hMem</a> | Handle to measurement device. |

#### 6.6.11.5.4 GUI\_MEASDEV\_GetRect()

##### Description

Retrieves the result of the drawing operations.

##### Prototype

```
void GUI_MEASDEV_GetRect(GUI_MEASDEV_Handle hMem,  
                        GUI_RECT * pRect);
```

##### Parameters

| Parameter          | Description                                    |
|--------------------|--|
| <code>hMem</code>  | Handle to measurement device.                  |
| <code>pRect</code> | Pointer to GUI_RECT-structure to store result. |

### 6.6.11.5.5 GUI\_MEASDEV\_Select()

#### Description

Selects a measurement device as target for drawing operations.

#### Prototype

```
void GUI_MEASDEV_Select(GUI_MEASDEV_Handle hMemDev);
```

#### Parameters

| Parameter | Description                   |
|-----------|-------------------------------|
| hMem      | Handle to measurement device. |

#### Example

The following example shows the use of a measurement device. It creates a measurement device, draws a line and displays the result of the measurement device:

```
void MainTask(void) {
    GUI_MEASDEV_Handle hMeasdev;
    GUI_RECT Rect;
    GUI_Init();
    hMeasdev = GUI_MEASDEV_Create();
    GUI_MEASDEV_Select(hMeasdev);
    GUI_DrawLine(10, 20, 30, 40);
    GUI_SelectLCD();
    GUI_MEASDEV_GetRect(hMeasdev, &Rect);
    GUI_MEASDEV_Delete(hMeasdev);
    GUI_DispString("X0:");
    GUI_DispDec(Rect.x0, 3);
    GUI_DispString(" Y0:");
    GUI_DispDec(Rect.y0, 3);
    GUI_DispString(" X1:");
    GUI_DispDec(Rect.x1, 3);
    GUI_DispString(" Y1:");
    GUI_DispDec(Rect.y1, 3);
}
```

#### Screenshot of the above example

```
X0:010 Y0:020 X1:030 Y1:040
```

## 6.6.11.6 Animation functions

Animations can be used to inject some life into the application. They will always help to let the user's eye smoothly capture what happens. All animation functions require 32-bit devices.

### 6.6.11.6.1 GUI\_MEMDEV\_FadeInDevices()

#### Description

Performs fading in one device over another Memory Device.

#### Prototype

```
int GUI_MEMDEV_FadeInDevices(GUI_MEMDEV_Handle hMem0,
                             GUI_MEMDEV_Handle hMem1,
                             int Period);
```

#### Parameters

| Parameter           | Description                                   |
|---------------------|---|
| <code>hMem0</code>  | Handle of background Memory Device.           |
| <code>hMem1</code>  | Handle of Memory Device to be faded in.       |
| <code>Period</code> | Time period in which the fading is processed. |

#### Return value

0 if successful.  
1 if the function fails.

#### Additional information

This function requires `hMem0` and `hMem1` to be of the same size and to be located at the same position on the screen.

#### Example

An example application using fading functions can be found in the file `MEMDEV_FadingPerformance.c` which is located in the folder `Sample\Tutorial`.

#### Screenshots



### 6.6.11.6.2 GUI\_MEMDEV\_FadeOutDevices()

#### Description

Performs fading out one device overlaying another Memory Device.

#### Prototype

```
int GUI_MEMDEV_FadeOutDevices(GUI_MEMDEV_Handle hMem0,  
                              GUI_MEMDEV_Handle hMem1,  
                              int Period);
```

#### Parameters

| Parameter              | Description                                   |
|------------------------|---|
| <a href="#">hMem0</a>  | Handle of background Memory Device.           |
| <a href="#">hMem1</a>  | Handle of Memory Device to be faded out.      |
| <a href="#">Period</a> | Time period in which the fading is processed. |

#### Return value

0 if successful.  
1 if the function fails.

#### Additional information

This function requires [hMem0](#) and [hMem1](#) to be of the same size and to be located at the same position on the screen.

### 6.6.11.6.3 GUI\_MEMDEV\_SetAnimationCallback()

#### Description

Sets a user defined callback function to be called while animations are processed. The function should contain code to determine whether processing of the current animation shall go on or abort.

#### Prototype

```
void GUI_MEMDEV_SetAnimationCallback(GUI_ANIMATION_CALLBACK_FUNC * pCbAnimation,
                                     void * pVoid);
```

#### Parameters

| Parameter                 | Description                                    |
|---------------------------|--|
| <code>pCbAnimation</code> | Pointer to the user defined callback function. |
| <code>pVoid</code>        | Data pointer.                                  |

#### Additional information

The callback function is called every time an animation function has just copied the actual step to the screen.

#### Example

The following example shows the use of a `GUI_ANIMATION_CALLBACK_FUNC`, which gives the possibility to react on PID events:

```
static int _cbAnimation(int TimeRem, void * pVoid) {
    int Pressed;
    if (TimeRem /* Insert Condition */) {
        /* ... React on remaining Time ... */
    }
    Pressed = _GetButtonState();
    if (Pressed) {
        return 1; // Button was pressed, stop animation
    } else {
        return 0; // Button was not pressed, continue animation
    }
}
void main(void) {
    GUI_Init();
    GUI_MEMDEV_SetAnimationCallback(_cbAnimation, (void *)&_Pressed);
    while (1) {
        /* Do animations... */
    }
}
```



#### 6.6.11.6.4 GUI\_MEMDEV\_SetTimePerFrame()

##### Description

Sets the minimum time used for one animation frame. If the process of drawing requires less time `GUI_X_Delay()` is called with the time difference.

##### Prototype

```
void GUI_MEMDEV_SetTimePerFrame(unsigned TimePerFrame);
```

##### Parameters

| Parameter                 | Description                                |
|---------------------------|--|
| <code>TimePerFrame</code> | Minimum time used for one animation frame. |

### 6.6.11.7 Animation functions (Window Manager required)

The following animation functions require usage of the Window Manager.

#### 6.6.11.7.1 GUI\_MEMDEV\_FadeInWindow()

#### 6.6.11.7.2 GUI\_MEMDEV\_FadeOutWindow()

##### Description

Fades in/out a window by decreasing/increasing the alpha value.

##### Prototypes

```
int GUI_MEMDEV_FadeInWindow (WM_HWIN hWin,
                             int      Period);
```

```
int GUI_MEMDEV_FadeOutWindow(WM_HWIN hWin,
                              int      Period);
```

##### Parameters

| Parameter           | Description                                     |
|---------------------|---|
| <code>hWin</code>   | Handle to the window which has to be faded out. |
| <code>Period</code> | Time period in which the fading is processed.   |

##### Return value

0 if successful.  
1 if the function fails.

##### Additional information

After the window has been faded the desktop and its child windows are validated.

##### Example

An example application using the fading functions for windows can be found in the file `SKINNING_NestedModal.c` which is located in the folder `Sample\Tutorial`.

##### Screenshots



### 6.6.11.7.3 GUI\_MEMDEV\_MoveInWindow()

### 6.6.11.7.4 GUI\_MEMDEV\_MoveOutWindow()

#### Description

Moves a window into/out of the screen. First the window is drawn minimized/maximized at the specified position/its actual position and then moved to its actual position/the specified position while magnifying to its actual size/demagnifying. The window can be spun clockwise as well as counterclockwise while it is moving.

#### Prototypes

```
int GUI_MEMDEV_MoveInWindow (WM_HWIN hWin,
                             int      x,
                             int      y,
                             int      a180,
                             int      Period);

int GUI_MEMDEV_MoveOutWindow(WM_HWIN hWin,
                             int      x,
                             int      y,
                             int      a180,
                             int      Period);
```

#### Parameters

| Parameter           | Description   |
|---------------------|---|
| <code>hWin</code>   | Handle to the window which has to be moved  |
| <code>x</code>      | Position in <code>x</code> from/to where the window is moved  |
| <code>y</code>      | Position in <code>y</code> from/to where the window is moved  |
| <code>a180</code>   | Count of degrees the window will be spun for: <code>a180 = 0</code> -> no spinning <code>a180 &gt; 0</code> -> clockwise <code>a180 &lt; 0</code> -> counterclockwise |
| <code>Period</code> | Time period in which the moving is processed  |

#### Return value

0        if successful.  
1        if the function fails.

#### Additional information

First the window is drawn maximized at its actual position and then moved to the specified position while demagnifying. The window can be spun clockwise as well as counterclockwise while it is moving. After the window has been moved the desktop and its child windows are validated. `GUI_MEMDEV_MoveOutWindow()` requires approximately 1 MB of dynamic memory to run properly in QVGA mode.

#### Example

An example application using the functions `GUI_MEMDEV_MoveInWindow()` and `GUI_MEMDEV_MoveOutWindow()` can be found in the file `SKINNING_NestedModal.c` which is located in the folder `Sample\Tutorial` folder.

### Screenshots

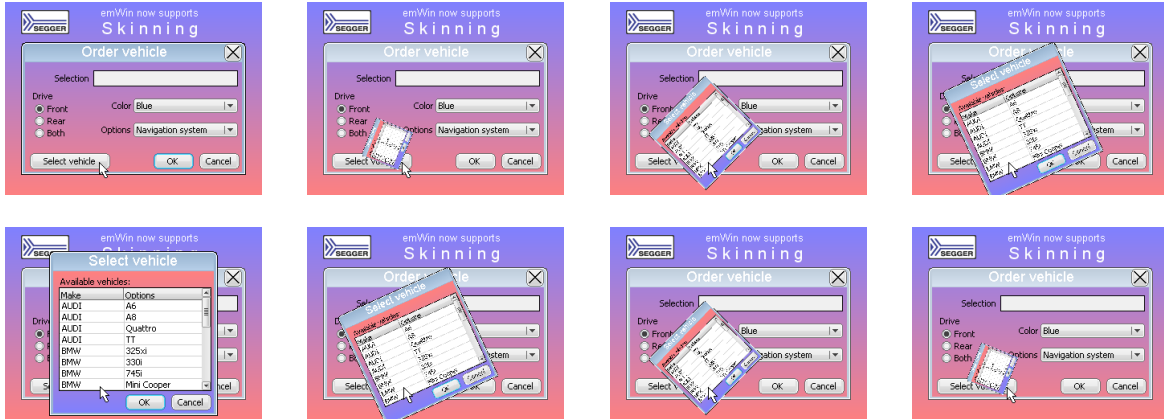

### 6.6.11.7.5 GUI\_MEMDEV\_ShiftInWindow()

### 6.6.11.7.6 GUI\_MEMDEV\_ShiftOutWindow()

#### Description

Shifts a Window in a specified direction into/out of the screen to/from its actual position.

#### Prototypes

```
int GUI_MEMDEV_ShiftInWindow (WM_HWIN hWin,
                             int      Period,
                             int      Direction);

int GUI_MEMDEV_ShiftOutWindow(WM_HWIN hWin,
                              int      Period,
                              int      Direction);
```

#### Parameters

| Parameter           | Description   |
|---------------------|---|
| <code>hWin</code>   | Handle to the window which has to be shifted.                     |
| <code>Period</code> | Time period in which the shifting is processed.                   |
| <code>Edge</code>   | See permitted values under <i>Direction symbols</i> on page 2712. |

#### Return value

0 if successful.  
1 if the function fails.

#### Additional information

After the window has been shifted the desktop and its child windows are validated. `GUI_MEMDEV_ShiftOutWindow()` requires approximately 1 MB of dynamic memory to run properly in QVGA mode.

#### Example

An example application using the functions `GUI_MEMDEV_ShiftInWindow()` and `GUI_MEMDEV_ShiftOutWindow()` can be found in the file `SKINNING_Notepad.c` which is located in the folder `Sample\Tutorial` folder.

#### Screenshots

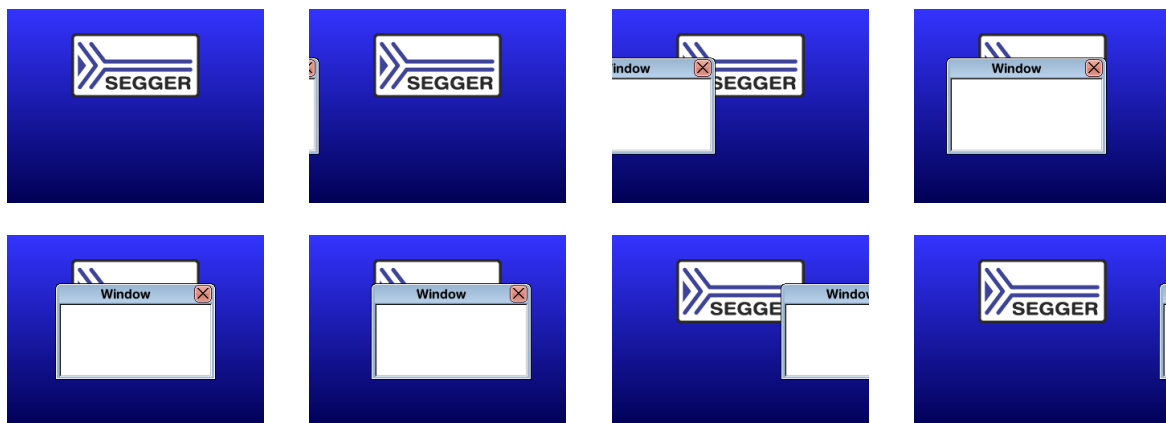

### 6.6.11.7.7 GUI\_MEMDEV\_SwapWindow()

#### Description

Swaps a window with the old content of the target area.

#### Prototype

```
int GUI_MEMDEV_SwapWindow(WM_HWIN hWin,
                          int      Period,
                          int      Edge);
```

#### Parameters

| Parameter           | Description   |
|---------------------|---|
| <code>hWin</code>   | Handle to the window which has to be swapped.                     |
| <code>Period</code> | Time period in which the shifting is processed.                   |
| <code>Edge</code>   | See permitted values under <i>Direction symbols</i> on page 2712. |

#### Return value

- 0 if successful.
- 1 if the function fails.

#### Additional information

After the window has been swapped the desktop and its child windows are validated. GUI\_MEMDEV\_SwapWindow() requires approximately 1 MB of dynamic memory to run properly in QVGA mode.

#### Screenshots

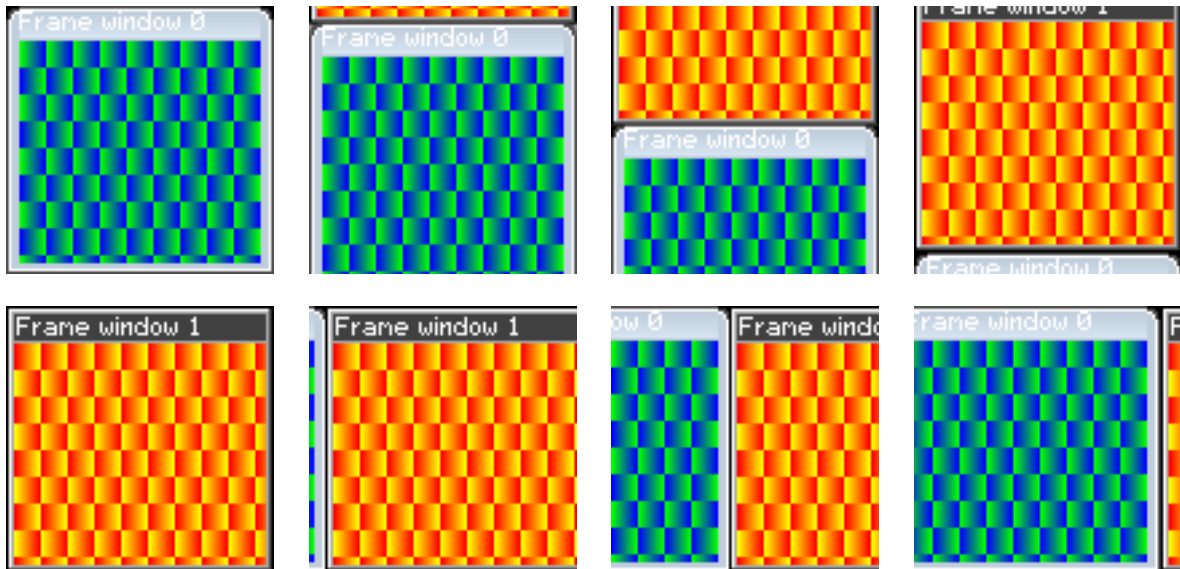

## 6.6.11.8 Blending, Blurring and Dithering functions

### 6.6.11.8.1 GUI\_MEMDEV\_BlendColor32()

#### Description

Blends a window with the given color and blending intensity.

#### Prototype

```
int GUI_MEMDEV_BlendColor32(GUI_MEMDEV_Handle hMem,
                             U32 BlendColor,
                             U8 BlendIntens);
```

#### Parameters

| Parameter                | Description  |
|--------------------------|--|
| <code>hMem</code>        | Handle to the Memory Device which has to be blended.                               |
| <code>BlendColor</code>  | Color which is used for the blending effect.                                       |
| <code>BlendIntens</code> | Intensity of the blending effect. Should be 0 (no blending) - 255 (full blending). |

#### Return value

0        on success  
1        on error.

### 6.6.11.8.2 GUI\_MEMDEV\_CreateBlurredDevice32()

#### Description

Creates a blurred copy of the given Memory Device using the currently set blurring function.

#### Prototype

```
GUI_MEMDEV_Handle GUI_MEMDEV_CreateBlurredDevice32(GUI_MEMDEV_Handle hMemSrc,
                                                    U8 Depth);
```

#### Parameters

| Parameter | Description  |
|-----------|--|
| hMem      | Handle to the Memory Device which has to be blurred.         |
| Depth     | Depth of the blurring effect. Should be specified with 1-10. |

#### Return value

Handle of the blurred Memory Device.

#### Additional information

The source Memory Device should consist of a color depth of 32 bpp. The resulting Memory Device will be of the same size at 32 bpp. Information about memory usage and performance can be found in the descriptions of the ...HQ() and ...LQ()-function. This function works according to the currently set blurring quality. In order to change the quality, the functions GUI\_MEMDEV\_SetBlurHQ() and GUI\_MEMDEV\_SetBlurLQ() can be used. The default quality is high.

#### Comparison

This screenshot shows the same elements without effect in the top row, blurred at high quality in the left column and blurred at low quality in the right column. The blurring depth was set as follows:

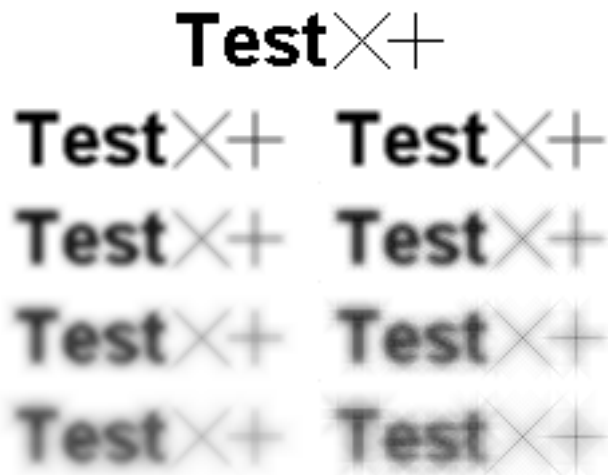

| Row number | Blurring depth |
|------------|----------------|
| 1st row    | 0              |
| 2nd row    | 1              |
| 3rd row    | 3              |
| 4th row    | 5              |
| 5th row    | 7              |



## Performance

The performance is given relative to the time it takes to create a blurred device at high quality using a blurring depth of 1.

| Blurring depth | High Quality | Low Quality |
|----------------|--------------|-------------|
| 1              | 1            | 1.32        |
| 3              | 3.54         | 2.01        |
| 5              | 8.65         | 2.65        |
| 7              | 16.16        | 3.26        |

According to the values creating a blurred device at high quality using a blurring depth of 5 takes approximately half the time it would take to create a blurred device at high quality using a blurring depth of 7.

### 6.6.11.8.3 GUI\_MEMDEV\_CreateBlurredDevice32HQ()

#### Description

Creates a blurred copy of the given Memory Device at high quality.

#### Prototype

```
GUI_MEMDEV_Handle GUI_MEMDEV_CreateBlurredDevice32HQ(GUI_MEMDEV_Handle hMemSrc,
                                                    U8 Depth);
```

#### Parameters

| Parameter             | Description  |
|-----------------------|--|
| <a href="#">hMem</a>  | Handle to the Memory Device which has to be blurred.                         |
| <a href="#">Depth</a> | <a href="#">Depth</a> of the blurring effect. Should be specified with 1-10. |

#### Return value

Handle of the blurred Memory Device. 0, if the function fails.

#### Additional information

The source Memory Device should consist of a color depth of 32 bpp. The resulting Memory Device will be of the same size at 32 bpp. This routine requires an addition of 16 bytes per pixel plus memory to allocate iterator arrays which are used to accelerate pixel addressing. The required memory for the iterator arrays depends on the blurring depth to perform. The number of bytes is calculated as follows:

```
Size = (1 + Depth * (Depth - 1) * 4) * (3 * sizeof(int) + 4)
```

A screenshot can be found under *GUI\_MEMDEV\_CreateBlurredDevice32* on page 2700.

#### 6.6.11.8.4 GUI\_MEMDEV\_CreateBlurredDevice32LQ()

##### Description

Creates a blurred copy of the given Memory Device at low quality.

##### Prototype

```
GUI_MEMDEV_Handle GUI_MEMDEV_CreateBlurredDevice32LQ(GUI_MEMDEV_Handle hMemSrc,  
                                                    U8 Depth);
```

##### Parameters

| Parameter             | Description  |
|-----------------------|--|
| <a href="#">hMem</a>  | Handle to the Memory Device which has to be blurred.                         |
| <a href="#">Depth</a> | <a href="#">Depth</a> of the blurring effect. Should be specified with 1-10. |

##### Return value

Handle of the blurred Memory Device. 0, if the function fails.

##### Additional information

The source Memory Device should consist of a color depth of 32 bpp. This is a creating function. The created Memory Device will be of the same size at 32 bpp. Beyond that no additional memory is required. A screenshot can be found under `GUI_MEMDEV_CreateBlurredDevice32()`.

### 6.6.11.8.5 GUI\_MEMDEV\_Dither32()

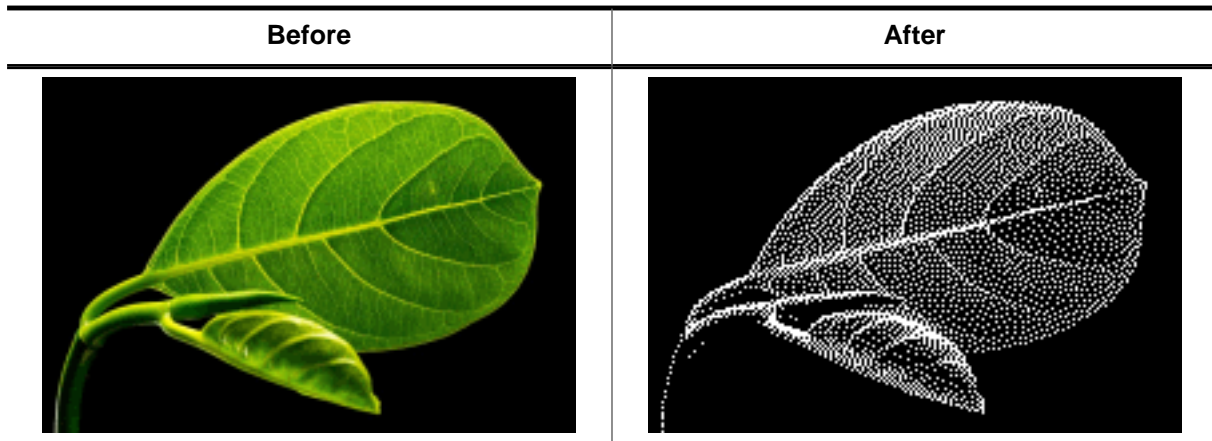

#### Description

The function dithers the given memory device using the given fixed palette mode. Please note that the function does not reduce the color depth of the memory device. If dithered images with a reduced color depth (and less storage requirement) are desired, the bitmap converter should be used to dither the images.

#### Prototype

```
int GUI_MEMDEV_Dither32(      GUI_MEMDEV_Handle  hMem,
                             const LCD_API_COLOR_CONV * pColorConvAPI);
```

#### Parameters

| Parameter                     | Description   |
|-------------------------------|---|
| <a href="#">hMem</a>          | Handle to the Memory Device which has to be dithered. |
| <a href="#">pColorConvAPI</a> | Color conversion to be used.                          |

#### Return value

0        on success  
1        on error.

#### Additional information

The function works only with memory devices having a color depth of 32bpp.

#### 6.6.11.8.6 GUI\_MEMDEV\_SetBlurHQ()

##### Description

Sets the blurring quality to high.

##### Prototype

```
void GUI_MEMDEV_SetBlurHQ(void);
```

##### Additional information

Setting the blurring quality affects the function GUI\_MEMDEV\_CreateBlurredDevice32() which in turn is called by other functions. (e.g. GUI\_MEMDEV\_BlurWinBk()).

### 6.6.11.8.7 GUI\_MEMDEV\_SetBlurLQ()

#### Description

Sets the blurring quality to low.

#### Prototype

```
void GUI_MEMDEV_SetBlurLQ(void);
```

#### Additional information

Additional information is stated under "GUI\_MEMDEV\_SetBlurHQ()".

## 6.6.11.9 Blending and Blurring functions (Window Manager required)

### 6.6.11.9.1 GUI\_MEMDEV\_BlendWinBk()

#### Description

Blends the background of a window within the given period from its initial state to the given blending intensity.

#### Prototype

```
int GUI_MEMDEV_BlendWinBk(WM_HWIN hWin,
                          int      Period,
                          U32      BlendColor,
                          U8       BlendIntens);
```

#### Parameters

| Parameter                | Description  |
|--------------------------|--|
| <code>hWin</code>        | Handle to the window which has to be blended.  |
| <code>Period</code>      | Effect <code>Period</code> .   |
| <code>BlendColor</code>  | Color which is used for the background to be blended with.                               |
| <code>BlendIntens</code> | Final intensity of the blending effect. Should be 0 (no blending) - 255 (full blending). |

#### Return value

0        on success  
1        on error.

#### Screenshots

The following screenshots show the background window being blended in 5 steps. The blending is performed using `GUI_BLACK` as `BlendColor`. `BlendIntens` is given with the highest possible value of 255.

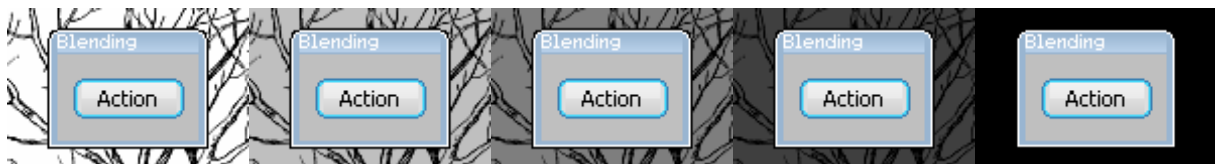

### 6.6.11.9.2 GUI\_MEMDEV\_BlurAndBlendWinBk()

#### Description

Blurs and blends the background of a window within the given period from its initial state to the given blurring value and blending intensity.

#### Prototype

```
int GUI_MEMDEV_BlurAndBlendWinBk(WM_HWIN hWin,
                                  int      Period,
                                  U8      BlurDepth,
                                  U32     BlendColor,
                                  U8      BlendIntens);
```

#### Parameters

| Parameter                | Description  |
|--------------------------|--|
| <code>hWin</code>        | Handle to the window which has to be blurred.  |
| <code>Period</code>      | Effect <code>Period</code> .   |
| <code>BlurDepth</code>   | Final depth of the blurring effect. Should be specified with 1-10.                       |
| <code>BlendColor</code>  | Color which is used for the background to be blended with.                               |
| <code>BlendIntens</code> | Final intensity of the blending effect. Should be 0 (no blending) - 255 (full blending). |

#### Return value

0        on success  
1        on error.

#### Additional information

The blurring quality can be changed using the functions `GUI_MEMDEV_SetBlurHQ()` or `GUI_MEMDEV_SetBlurLQ()`.

#### Screenshots

The following screenshots show the background window being blurred and blended in 5 steps. The used values are 10 as blurring depth and 64 as blending intensity. The blending color is `GUI_WHITE`.

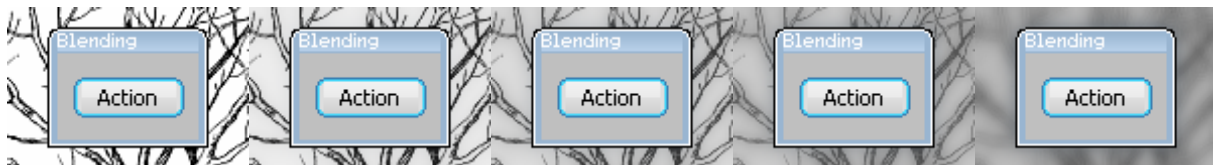



### 6.6.11.9.3 GUI\_MEMDEV\_BlurWinBk()

#### Description

Blurs the background of a window within the given period from its initial state to the given blurring value.

#### Prototype

```
int GUI_MEMDEV_BlurWinBk(WM_HWIN hWin,
                          int      Period,
                          U8       BlurDepth);
```

#### Parameters

| Parameter              | Description  |
|------------------------|--|
| <code>hWin</code>      | Handle to the window whose background has to be blurred.           |
| <code>Period</code>    | Effect <code>Period</code> .                                       |
| <code>BlurDepth</code> | Final depth of the blurring effect. Should be specified with 1-10. |

#### Return value

0        on success  
1        on error.

#### Additional information

The blurring quality can be changed using the functions `GUI_MEMDEV_SetBlurHQ()` or `GUI_MEMDEV_SetBlurLQ()`.

#### Screenshots

The following screenshots show the background window being blurred in 5 steps. The used blurring depth is 10.

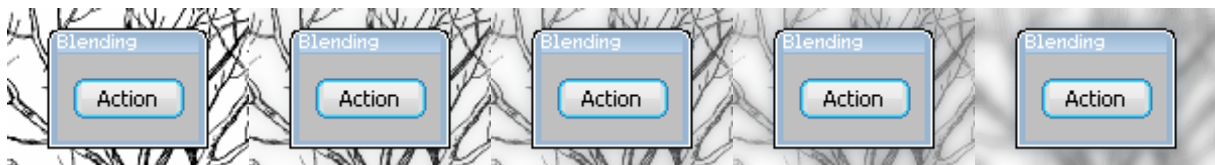

### 6.6.11.10 Setting up multiple buffering for animation functions

'Animation functions' refers to all functions listed in chapters

- *Animation functions* on page 2690
- *Animation functions (Window Manager required)* on page 2694
- *Blending, Blurring and Dithering functions* on page 2699
- *Blending and Blurring functions (Window Manager required)* on page 2707

#### 6.6.11.10.1 GUI\_MEMDEV\_MULTIBUF\_Enable()

##### Description

Normally memory device animation functions do not use multiple buffers. But under certain circumstances it could make sense to enable multiple buffers here. If enabled, the animation functions use `GUI_MULTIBUF_Begin()` and `GUI_MULTIBUF_End()` before/after drawing the memory device on the display.

##### Prototype

```
int GUI_MEMDEV_MULTIBUF_Enable(int OnOff);
```

##### Parameters

| Parameter          | Description  |
|--------------------|--|
| <code>OnOff</code> | Use 1 for enabling, 0 for disabling use of multiple buffers. |

##### Return value

Previous state.

##### Additional information

Normally memory device animation functions do not use multiple buffers. But under certain circumstances it could make sense to enable multiple buffers here. If enabled, the animation functions use `GUI_MULTIBUF_Begin()` and `GUI_MULTIBUF_End()` before/after drawing the memory device on the display. That function makes sense in connection with '`GUI_D-CACHE_SetClearCacheHook()`'.

## 6.6.11.11 Defines

### 6.6.11.11.1 Color conversion routines

#### Description

This parameter defines the desired color conversion. For more details about the used bits per pixel and the color conversion, refer to the chapter *Colors* on page 478.

#### Definition

```
#define GUICC_1          &LCD_API_ColorConv_1
#define GUICC_2          &LCD_API_ColorConv_2
#define GUICC_4          &LCD_API_ColorConv_4
#define GUICC_565        &LCD_API_ColorConv_565
#define GUICC_M565       &LCD_API_ColorConv_M565
#define GUICC_8666       &LCD_API_ColorConv_8666
#define GUICC_888        &LCD_API_ColorConv_888
#define GUICC_8888       &LCD_API_ColorConv_8888
```

#### Symbols

| Definition | Description                            |
|------------|--|
| GUICC_1    | Fixed palette mode 1. (black/white)    |
| GUICC_2    | Fixed palette mode 2. (4 gray scales)  |
| GUICC_4    | Fixed palette mode 4. (16 gray scales) |
| GUICC_565  | Fixed palette mode 565.                |
| GUICC_M565 | Fixed palette mode M565.               |
| GUICC_8666 | Fixed palette mode 8666.               |
| GUICC_888  | Fixed palette mode 888.                |
| GUICC_8888 | Fixed palette mode 8888.               |

### 6.6.11.11.2 Direction symbols

#### Description

Symbols used by memory device routines to determine in which direction a window should be moved.

#### Definition

```
#define GUI_MEMDEV_EDGE_LEFT      0
#define GUI_MEMDEV_EDGE_RIGHT    1
#define GUI_MEMDEV_EDGE_TOP      2
#define GUI_MEMDEV_EDGE_BOTTOM   3
```

#### Symbols

| Definition                             | Description                 |
|--|-----------------------------|
| <a href="#">GUI_MEMDEV_EDGE_LEFT</a>   | Shift window to the left.   |
| <a href="#">GUI_MEMDEV_EDGE_RIGHT</a>  | Shift window to the right.  |
| <a href="#">GUI_MEMDEV_EDGE_TOP</a>    | Shift window to the top.    |
| <a href="#">GUI_MEMDEV_EDGE_BOTTOM</a> | Shift window to the bottom. |

#### See also

- [GUI\\_MEMDEV\\_ShiftInWindow\(\)](#)
- [GUI\\_MEMDEV\\_ShiftOutWindow\(\)](#)
- [GUI\\_MEMDEV\\_SwapWindow\(\)](#)

### 6.6.11.11.3 Memory device color depths

#### Description

Defines the color depth of the Memory Device in bpp. The color depth of the Memory Device should be equal or greater than the required bits for the color conversion routines.

#### Definition

```
#define GUI_MEMDEV_APILIST_1      &GUI_MEMDEV_DEVICE_1
#define GUI_MEMDEV_APILIST_8      &GUI_MEMDEV_DEVICE_8
#define GUI_MEMDEV_APILIST_16     &GUI_MEMDEV_DEVICE_16
#define GUI_MEMDEV_APILIST_32     &GUI_MEMDEV_DEVICE_32
```

#### Symbols

| Definition                            | Description  |
|---------------------------------------|--|
| <a href="#">GUI_MEMDEV_APILIST_1</a>  | Create Memory Device with 1bpp color depth (1 byte per 8 pixels). Use if the specified color conversion requires 1bpp.                             |
| <a href="#">GUI_MEMDEV_APILIST_8</a>  | Create Memory Device with 8bpp color depth (1 byte per pixel). Use if the specified color conversion requires 8bpp or less.                        |
| <a href="#">GUI_MEMDEV_APILIST_16</a> | Create Memory Device with 16bpp color depth (1 U16 per pixel). Use if the specified color conversion requires more than 8 bpp (high color modes).  |
| <a href="#">GUI_MEMDEV_APILIST_32</a> | Create Memory Device with 32bpp color depth (1 U32 per pixel). Use if the specified color conversion requires more than 16 bpp (true color modes). |

#### Additional information

A Memory Device with a 1bpp color conversion ([GUI\\_COLOR\\_CONV\\_1](#)) for example requires at least a Memory Device with 1bpp color depth. The available Memory Devices are 1bpp, 8bpp, 16bpp and 32bpp Memory Devices. So an 1bpp Memory Device should be used.

If using a 4 bit per pixel color conversion ([GUI\\_COLOR\\_CONV\\_4](#)) at least 4bpp are needed for the Memory Device. In this case an 8bpp Memory Device should be used.

#### 6.6.11.11.4 Memory device flags

##### Description

Flags to be used for the creation of a memory device.

##### Definition

```
#define GUI_MEMDEV_HASTRANS    0
#define GUI_MEMDEV_NOTRANS    (1 << 0)
```

##### Symbols

| Definition                          | Description  |
|-------------------------------------|--|
| <a href="#">GUI_MEMDEV_HASTRANS</a> | Default: The Memory Device is created with a transparency flag which ensures that the background will be drawn correctly.  |
| <a href="#">GUI_MEMDEV_NOTRANS</a>  | Creates a Memory Device without transparency. The user must make sure that the background is drawn correctly. This way the Memory Device can be used for non-rectangular areas. An other advantage is the higher speed: Using this flag accelerates the Memory Device approx. by 30 - 50%. |

## 6.7 MultiTouch support (MT)

Initially the concept of emWin was based on a single touch and keyboard interface. Since smartphones with MultiTouch capabilities became more and more attractive, it was a need to implement MultiTouch capabilities also to emWin. The emWin implementation is able to recognize up to 10 touch points, whereas the maximum number of touch points is limited by the target hardware.

Single touch screens usually consist of resistive touch panels. Most of the MultiTouch panels are capacitive panels which behave different to resistive panels. Whereas a resistive touch panel needs a noticeable pressure, a capacitive panel just requires a smooth touch for recognizing the touch event.

MultiTouch support is an add-on and not part of the emWin basic package. It has to be purchased separately. The emWin Simulation supports the MultiTouch feature, so it is possible to evaluate MultiTouch samples which are provided on [www.segger.com](http://www.segger.com). To do so it is necessary to have a MultiTouch display connected to the computer.

The following chapter shows the implementation of MultiTouch functionality in emWin.

### 6.7.1 Introduction

A MultiTouch panel enables the application to react on multiple touch point inputs simultaneously. The implementation of MT support in emWin offers different consecutive levels of MT access:

- Basic buffer access
- Gesture support (requires the Window Manager)
- Automatic window animation (requires the Window Manager) Gesture support requires basic buffer access, window animation is based on gesture support.

#### Basic buffer access

The MT buffer is able to store a configurable number of MT events. The buffer access API functions consists of functions for storing new events, polling the buffer, setting the touch screen orientation and basically enabling MT support. A detailed description of the available API functions follows later.

#### Gesture support

This level of MT support is responsible for gesture recognition and requires the window manager. If a gesture is detected, a `WM_GESTURE` message with more detailed information is send to the according window. It can be used to modify any kind of data. Detailed descriptions how to use the gesture messages follow later.

#### Window animation

emWin also offers the possibility for automatic window animation via gesture support. Windows can be moved and resized automatically by gesture input. This can be achieved simply by setting the according flags when creating the window. It does not include automatic resizing of fonts and objects shown in the window. This need to be done by the application based on a factor which is passed to/from the application. Details follow later in this chapter.

## 6.7.2 Getting started

Only a few things need to be considered to be able to use MT support. It needs to be enabled, the MT buffer needs to be filled and it must be ensured that the buffer is polled by emWin if gesture support or window animation is required.

### Enabling MS support

To be able to use MT support it needs to be enabled once. It is recommended to do that immediately after the initialization:

```
void MainTask(void) {
    GUI_Init();
    GUI_MTOUCH_Enable(1);
}
```

### Filling the MT buffer

Further it is required to fill the MT buffer with MT events. That can be done either by an existing MT driver like `GUIMTDRV_TangoC32` or by filling the buffer by a custom driver. In case of using a custom driver the function `GUI_MTOUCH_StoreEvent()` needs to be used to do that. The function will be explained later in detail.

### Polling the MT buffer

Once MT support has been enabled, the window manager (WM) automatically polls the MT buffer. That is done when executing an emWin update function (typically `GUI_Exec()`, `GUI_Delay()` or `WM_Exec()`). If no gesture support is required the buffer can also be polled manually by the functions `GUI_MTOUCH_GetEvent()` and `GUI_MTOUCH_GetTouchInput()`. In case of automatic polling by emWin the gesture detecting module will automatically send `WM_GESTURE` messages to the according window.



## 6.7.3 Using basic buffer access

The functions explained later under *Basic buffer access API* on page 2721 can be used for that. Polling works as follows:

### Polling an MT event from the buffer

`GUI_MTOUCH_GetEvent()` should be used to get an existing MT event from the buffer. It passes a pointer to a `GUI_MTOUCH_EVENT` structure to the function to be filled with information like the number of touch points of the current event. If the function fails there is no existing event. Otherwise the `GUI_MTOUCH_EVENT` structure contains the number of touch points associated to the event.

### Getting the touch points of an MT event

`GUI_MTOUCH_GetTouchInput()` should be used for getting the point information for each single touch point. It passes a pointer to a `GUI_MTOUCH_INPUT` structure to the function to be filled by the function. That information comprises position, ID and flags.

### Example 1

The following code shows a very simple function which continuously polls the MT buffer and draws each touch point:

```
#include "GUI.h"
void MainTask(void) {
    GUI_MTOUCH_EVENT Event;
    GUI_MTOUCH_INPUT Input;
    unsigned i;
    GUI_Init();
    GUI_MTOUCH_Enable(1);
    GUI_SetPenSize(5);
    do {
        if (GUI_MTOUCH_GetEvent(&Event) == 0) {
            for (i = 0; i < Event.NumPoints; i++) {
                GUI_MTOUCH_GetTouchInput(&Event, &Input, i);
                GUI_DrawPoint(Input.x, Input.y);
            }
        }
        GUI_Delay(1);
    } while (1);
}
```

### Screenshot of above sample

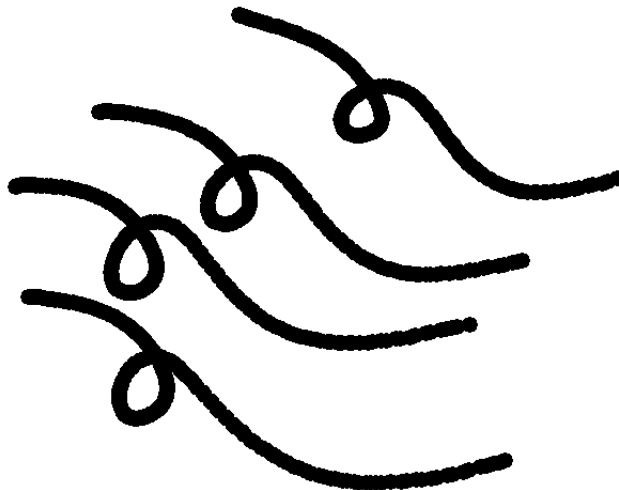

## Example 2

The sample folder of emWin contains the sample `MTOUCH_ScratchAndGestures.c`. It can be used to get more familiar with processing basic buffer access and MT support. It contains a scratchpad sub sample which detects multiple points and uses their IDs for assigning a unique color.

## Screenshot

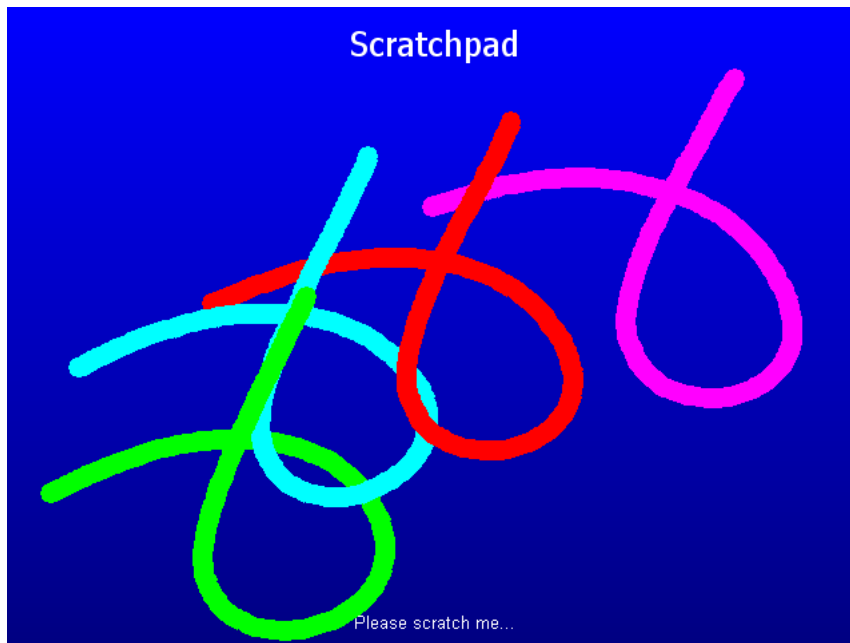

## 6.7.4 Using gestures

Gestures in emWin are based on motion detection via MultiTouch panel. Each gesture starts by detecting the first touch input and ends on releasing it.

### Requirements

To be able to use gesture support, the following needs to be considered:

- MT support needs to be enabled.
- Gesture support needs to be enabled via `WM_GESTURE_Enable()`.
- The flag `WM_CF_GESTURE` needs to be set by the according window.

### Supported gestures

The following table gives an overview of the currently supported gestures:

| Gesture         | Touch points | Description  |
|-----------------|--------------|--|
| <b>Panning</b>  | 1            | Dependent on the first motion detection the gesture supports motion on one axis (X or Y) or both simultaneous.   |
| <b>Zooming</b>  | 2            | This gesture is started when detecting a relative motion between 2 touch points and can be used to scale an object. Can be combined with rotating and panning. |
| <b>Rotating</b> | 2            | When detecting initially a change of the angle between 2 touch points rotation gesture is started. Can be combined with zooming and panning.                   |

### Processing gesture input

Gesture input is send to the according window by a `WM_GESTURE` message. For detailed gesture information a pointer to a structure of type `WM_GESTURE_INFO` (explained in detail below) is passed to the window. The "Flags" element of that structure is used to specify the kind of information passed to the window.

The supported flags are listed under *MultiTouch gesture flags* on page 2733.

The structure explained under `WM_GESTURE_INFO` on page 2730 explains all elements which are relevant for processing gesture messages. The `pZoomInfo` element should not be used by the application.

### Example

The sample folder of emWin contains the sample `MTOUCH_ScratchAndGestures.c`. It can be used to get more familiar with processing gestures and MT support. It contains a sub sample which animates a small vector graphic by gesture functions.

### Screenshot

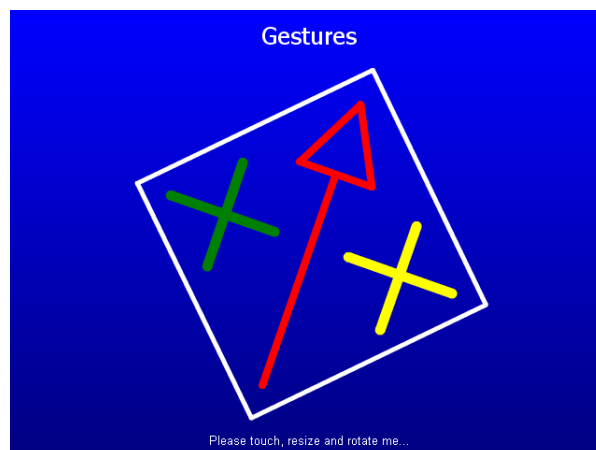

## 6.7.5 Window animation

Automatic window animation can be used to scale and pan windows automatically by gesture input. Currently that feature can be used for bare windows and can not be used with any of the widgets. Scaling of objects shown within scaled windows need to be done by the application. For that purpose the element "Factor" of the `WM_GESTURE_INFO` structure can be used as explained in the following.

### Requirements

To be able to use automatic window animation, the following needs to be considered:

- MT support needs to be enabled.
- Gesture support needs to be enabled via `WM_GESTURE_Enable()`.
- The window flags `WM_CF_GESTURE` and `WM_CF_ZOOM` need to be set.
- The window has to pass a pointer to a `WM_ZOOM_INFO` structure on demand.

### Reacting on gestures

Processing automatic window animation is similar to bare gesture support with the difference, that the object to be animated is the window itself which is modified automatically by `emWin`. But to be able to do this automatic animation the window manager needs additional information. This is done by passing a pointer to a `WM_ZOOM_INFO` structure to the WM. It is passed by the `pZoomInfo` element of the structure `WM_GESTURE_INFO`.

### Limits

The window to be animated can be moved and scaled by using the parent window as a kind of view port. If the size of the animated window is larger than the parent the WM makes sure that the zoomed window covers the complete area of the parent window. If it is smaller the WM makes sure, that it is not moved over the parents border.

### Scalable fonts

Text can be rendered at different sizes using scalable TrueType fonts. This requires a fast CPU and a reasonable amount of RAM and ROM. Details can be found in the chapter *TrueType Font (TTF) format* on page 531.

## 6.7.6 Basic buffer access API

The table below lists the available MT buffer access routines in alphabetical order. Detailed descriptions follow:

### Functions

| Routine                                  | Description   |
|--|---|
| <code>GUI_MTOUCH_Enable()</code>         | This routine needs to be called to enable the MT buffer.  |
| <code>GUI_MTOUCH_GetEvent()</code>       | Returns an event and removes it from the buffer.  |
| <code>GUI_MTOUCH_GetTouchInput()</code>  | This function is responsible for getting information of a dedicated touch point.                                    |
| <code>GUI_MTOUCH_IsEmpty()</code>        | Returns if the MT buffer is empty or not.   |
| <code>GUI_MTOUCH_SetOrientation()</code> | This function can be used to set the touch screen orientation, e.g.   |
| <code>GUI_MTOUCH_StoreEvent()</code>     | Routine to be used by the touch screen driver to store a new event with associated touch points into the MT buffer. |

### Data structures

| Structure                     | Description  |
|-------------------------------|--|
| <code>GUI_MTOUCH_EVENT</code> | Data structure used by <code>GUI_MTOUCH_GetEvent()</code> to store a multi touch event in. |
| <code>GUI_MTOUCH_INPUT</code> | Data structure used by <code>GUI_MTOUCH_GetEvent()</code> to store a multi touch event in. |
| <code>WM_GESTURE_INFO</code>  | Stores the information about a gesture.  |
| <code>WM_ZOOM_INFO</code>     |  |

### Defines

| Group of defines                      | Description  |
|---------------------------------------|--|
| <code>MultiTouch flags</code>         | Data structure used by <code>GUI_MTOUCH_GetEvent()</code> to store a multi touch event in. |
| <code>MultiTouch gesture flags</code> | Flags used for processing gesture input.   |

## 6.7.6.1 Functions

### 6.7.6.1.1 GUI\_MTOUCH\_Enable()

#### Description

This routine needs to be called to enable the MT buffer.

#### Prototype

```
void GUI_MTOUCH_Enable(int OnOff);
```

#### Parameters

| Parameter | Description                                 |
|-----------|---|
| OnOff     | 1 for enabling the buffer, 0 for disabling. |

### 6.7.6.1.2 GUI\_MTOUCH\_GetEvent()

#### Description

Returns an event and removes it from the buffer.

#### Prototype

```
int GUI_MTOUCH_GetEvent(GUI_MTOUCH_EVENT * pEvent);
```

#### Parameters

| Parameter           | Description  |
|---------------------|--|
| <code>pEvent</code> | Pointer to a structure of type <code>GUI_MTOUCH_EVENT</code> to be filled by the function. |

#### Return value

- 0 on success
- 1 if the function fails. Can be used to check if an event was available or not.

#### Additional information

The most important information returned by that function is the availability of an event and how many touch points are available. Further the time stamp may be of interest which is filled automatically on storing an event into the buffer.

### 6.7.6.1.3 GUI\_MTOUCH\_GetTouchInput()

#### Description

This function is responsible for getting information of a dedicated touch point. It requires a pointer to a `GUI_MTOUCH_EVENT` structure previously filled by `GUI_MTOUCH_GetEvent()` and a pointer to a `GUI_MTOUCH_INPUT` structure to be filled by this function with the touchpoint details.

#### Prototype

```
int GUI_MTOUCH_GetTouchInput (GUI_MTOUCH_EVENT * pEvent,
                             GUI_MTOUCH_INPUT * pInput,
                             unsigned          Index);
```

#### Parameters

| Parameter            | Description  |
|----------------------|--|
| <code>pEvent</code>  | Pointer to the event structure filled by <code>GUI_MTOUCH_GetEvent()</code> .              |
| <code>pBuffer</code> | Pointer to a structure of type <code>GUI_MTOUCH_INPUT</code> to be filled by the function. |
| <code>Index</code>   | <code>Index</code> of the requested touch point.   |

#### Return value

0        on success  
1        on error.

#### Additional information

The parameter `Index` needs to be < the available number of touch points. A unique `Id` is normally managed the touch controller which is passed by the `Id` element of `GUI_MTOUCH_INPUT`.



#### 6.7.6.1.4 GUI\_MTOUCH\_IsEmpty()

##### Description

Returns if the MT buffer is empty or not.

##### Prototype

```
int GUI_MTOUCH_IsEmpty(void);
```

##### Return value

1        if buffer is empty.  
0        if it contains MT events.

### 6.7.6.1.5 GUI\_MTOUCH\_SetOrientation()

#### Description

This function can be used to set the touch screen orientation, e.g. if the display does not operate by the default orientation or if the display orientation is different to the MT orientation.

#### Prototype

```
void GUI_MTOUCH_SetOrientation(int Orientation);
```

#### Parameters

| Parameter                   | Description   |
|-----------------------------|---|
| <a href="#">Orientation</a> | One or more "OR" combined values of the table below |

### 6.7.6.1.6 GUI\_MTOUCH\_StoreEvent()

#### Description

Routine to be used by the touch screen driver to store a new event with associated touch points into the MT buffer. The number of available touch points is passed by the `NumPoints` element of the structure pointed by `pEvent`. `pInput` then points to an array of `GUI_MTOUCH_INPUT` structures containing the information of each touch point.

#### Prototype

```
void GUI_MTOUCH_StoreEvent(GUI_MTOUCH_EVENT * pEvent,  
                           GUI_MTOUCH_INPUT * pInput);
```

#### Parameters

| Parameter           | Description   |
|---------------------|---|
| <code>pEvent</code> | Pointer to a structure of type <code>GUI_MTOUCH_EVENT</code> .                        |
| <code>pInput</code> | Pointer to the first element of an array of <code>GUI_MTOUCH_INPUT</code> structures. |

#### Additional information

The number of possible touch points is limited per default to 10. The new event will automatically get a time stamp information which can be used later.

#### Note

Make sure that the element `Id` of `GUI_MTOUCH_INPUT` is  $\neq 0$ .

## 6.7.6.2 Data structures

### 6.7.6.2.1 GUI\_MTOUCH\_EVENT

#### Description

Data structure used by `GUI_MTOUCH_GetEvent()` to store a multi touch event in.

#### Type definition

```
typedef struct {  
    int          LayerIndex;  
    unsigned     NumPoints;  
    GUI_TIMER_TIME TimeStamp;  
    PTR_ADDR     hInput;  
} GUI_MTOUCH_EVENT;
```

#### Structure members

| Member                  | Description                                |
|-------------------------|--|
| <code>LayerIndex</code> | Layer index of touched layer (normally 0). |
| <code>NumPoints</code>  | Number of available touch points.          |
| <code>TimeStamp</code>  | Time stamp in ms of that event.            |
| <code>hInput</code>     | Internal use.                              |

### 6.7.6.2.2 GUI\_MTOUCH\_INPUT

#### Description

Data structure used by `GUI_MTOUCH_GetEvent()` to store a multi touch event in.

#### Type definition

```
typedef struct {  
    I32  x;  
    I32  y;  
    U32  Id;  
    U16  Flags;  
} GUI_MTOUCH_INPUT;
```

#### Structure members

| Member             | Description  |
|--------------------|--|
| <code>x</code>     | X-position in pixels of the touch point.   |
| <code>y</code>     | Y-position in pixels of the touch point.   |
| <code>Id</code>    | Unique <code>Id</code> , should be provided by the touch driver. Make sure that this element is $\neq 0$ . |
| <code>Flags</code> | See <i>MultiTouch flags</i> on page 2732.  |

### 6.7.6.2.3 WM\_GESTURE\_INFO

#### Description

Stores the information about a gesture.

#### Type definition

```
typedef struct {
    int          Flags;
    GUI_POINT    Point;
    GUI_POINT    Center;
    I32          Angle;
    I32          Factor;
    WM_ZOOM_INFO * pZoomInfo;
} WM_GESTURE_INFO;
```

#### Structure members

| Member                    | Description   |
|---------------------------|---|
| <a href="#">Flags</a>     | Information regarding gesture type. See <i>MultiTouch gesture flags</i> on page 2733.   |
| <a href="#">Point</a>     | Relative movement to be processed by the application.   |
| <a href="#">Center</a>    | <a href="#">Center</a> point for zooming.   |
| <a href="#">Angle</a>     | Relative angle difference to be processed by the application.   |
| <a href="#">Factor</a>    | When starting a zoom gesture the application has to set the element to the initial value for the gesture. After that during the gesture it contains the updated value to be processed by the application. |
| <a href="#">pZoomInfo</a> | Pointer to be set to a valid location of a WM_ZOOM_INFO structure. The application should keep sure, that the location remains valid during the gesture.  |

### 6.7.6.2.4 WM\_ZOOM\_INFO

#### Type definition

```
typedef struct {
    I32      FactorMin;
    I32      FactorMax;
    U32      xSize;
    U32      ySize;
    U32      xSizeParent;
    U32      ySizeParent;
    I32      Factor0;
    int      xPos0;
    int      yPos0;
    GUI_POINT Center0;
} WM_ZOOM_INFO;
```

#### Structure members

| Member                      | Description  |
|-----------------------------|--|
| <a href="#">FactorMin</a>   | Minimum factor to be used (<< 16).                             |
| <a href="#">FactorMax</a>   | Maximum factor to be used (<< 16).                             |
| <a href="#">xSize</a>       | Native <a href="#">xSize</a> of window to be zoomed in pixels. |
| <a href="#">ySize</a>       | Native <a href="#">ySize</a> of window to be zoomed in pixels. |
| <a href="#">xSizeParent</a> | Internal use.  |
| <a href="#">ySizeParent</a> | Internal use.  |
| <a href="#">Factor0</a>     | Internal use.  |
| <a href="#">xPos0</a>       | Internal use.  |
| <a href="#">yPos0</a>       | Internal use.  |
| <a href="#">Center0</a>     | Internal use.  |

## 6.7.6.3 Defines

### 6.7.6.3.1 MultiTouch flags

#### Description

Data structure used by `GUI_MTOUCH_GetEvent()` to store a multi touch event in.

#### Definition

```
#define GUI_MTOUCH_FLAG_DOWN    (1 << 0)
#define GUI_MTOUCH_FLAG_MOVE   (1 << 1)
#define GUI_MTOUCH_FLAG_UP     (1 << 2)
```

#### Symbols

| Definition                           | Description                              |
|--------------------------------------|--|
| <a href="#">GUI_MTOUCH_FLAG_DOWN</a> | New touch point has touched the surface. |
| <a href="#">GUI_MTOUCH_FLAG_MOVE</a> | Touch point has been moved.              |
| <a href="#">GUI_MTOUCH_FLAG_UP</a>   | Touch point has released the surface.    |



### 6.7.6.3.2 MultiTouch gesture flags

#### Description

Flags used for processing gesture input.

#### Definition

```
#define WM_GF_BEGIN      (1 << 0)
#define WM_GF_END       (1 << 1)
#define WM_GF_PAN       (1 << 2)
#define WM_GF_ZOOM      (1 << 3)
#define WM_GF_ROTATE    (1 << 4)
#define WM_GF_DTAP     (1 << 5)
```

#### Symbols

| Definition                   | Description  |
|------------------------------|--|
| <a href="#">WM_GF_BEGIN</a>  | This flag is set when sending the first message for the gesture.   |
| <a href="#">WM_GF_END</a>    | Set when releasing a touch point at the end of a gesture.  |
| <a href="#">WM_GF_PAN</a>    | A panning gesture is detected. The element "Point" of WM_GESTURE_INFO contains the relative movement in pixels to be processed by the application.   |
| <a href="#">WM_GF_ZOOM</a>   | Zooming is active. When starting a zooming gesture the element "Factor" of WM_GESTURE_INFO has to be set to the initial value to be used by the gesture. During the gesture the same element contains the updated value to be processed by the application. If movement should be considered simultaneously the element "Point" contains also the relative movement. |
| <a href="#">WM_GF_ROTATE</a> | Rotation is active. The element "Angle" of WM_GESTURE_INFO contains the relative movement in degrees (<< 16) to be processed by the application. To be able to achieve a smooth rotation the value is passed in 1/65536 degrees. If movement should be considered simultaneously the element "Point" contains also the relative movement.                            |
| <a href="#">WM_GF_DTAP</a>   | Internal use.  |

## 6.8 VNC Server

The emWin VNC server can be used for administration of the embedded target and a variety of other purposes. It supports compressed (hextile) encoding. VNC stands for 'Virtual Network Computing'. It is a client server system based on a simple display protocol which allows the user to view and control a computing 'desktop' environment from anywhere on the Internet and from a wide variety of machine architectures, communicating via TCP/IP.

In other words: The display contents of the embedded device are visible on the screen of the machine running the client (for example, your PC); your mouse and keyboard can be used to control the target.

This feature is available in the emWin simulation and trial versions. emWin VNC support is available as a separate package and is therefore not included in the basic package. VNC support requires emWin color.

If a file system is available, it is possible to achieve file transfers between client and target together with the emWin VNC client.

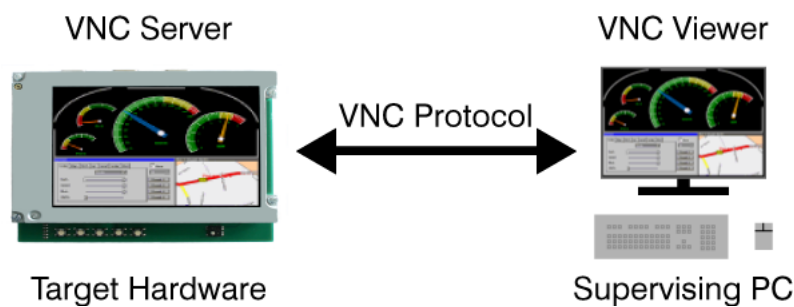

## 6.8.1 Introduction

VNC consists of two types of components. A server, which generates a display, and a viewer, which actually draws the display on your screen. The remote machine (target or simulation) can not only be viewed, but also controlled via mouse or keyboard. The server and the viewer may be on different machines and on different architectures. The protocol (RFB V3.3) which connects the server and viewer is simple, open, and platform independent. No state is stored at the viewer. Breaking the viewer's connection to the server and then reconnecting will not result in any loss of data. Because the connection can be remade from somewhere else, you have easy mobility. Using the VNC server, you may control your target from anywhere and you can make screenshots (for example, for a manual) from a "live" system.

### 6.8.1.1 Filetransfer

In addition to the default functionality of RFB V3.3 the emWin VNC server supports file transfers. Please note that file transfer is not part of the RFB protocol.

#### **Only supported client for file transfer is emVNC**

There does not exist a standard for file transfer operations within the RFB protocol. Because of that it requires a non-standard protocol extension which only works with the emVNC client. Only emVNC can be used for file transfers between the emWin VNC server and the client machine.

### 6.8.1.2 Requirements

#### **TCP/IP stack**

Since the communication between the server and the viewer is based on a TCP/IP connection, VNC requires a TCP/IP stack. In the Win32 simulation environment, TCP/IP (Winsock) is normally present. In the target, a TCP/IP stack needs to be present. The TCP/IP stack is NOT part of emWin. The flexible interface ensures that any TCP/IP stack can be used.

#### **Multi tasking**

The VNC server needs to run as a separate thread. Therefore a multi tasking system is required to use the emWin VNC server.

#### **File system (only for file transfers)**

A file system is required only if the file transfer feature should be used.

### 6.8.1.3 Notes on this implementation

#### **Supported client to server messages**

The emWin VNC server supports pointer event messages and keyboard event messages.

#### **Encoding**

The server supports raw encoding and hextile encoding.

#### **Performance**

Most viewers support hextile encoding, which supports descent compression. A typical quarter VGA screen requires typically 20 - 50 KB of data.

The server handles incremental updates; in most cases the updated display area is a lot smaller than the entire display and less data needs to be transmitted.

The following table shows some performance examples:

| Hardware / Configuration                               | ms / screen |
|--|-------------|
| STM32F4, 168MHz, internal RAM, WQVGA, 16bpp, HexTile   | 32 ms       |
| STM32F4, 168MHz, internal RAM, WQVGA, 16bpp, Raw       | 76 ms       |
| ARM7, 50MHz, external RAM cached, QVGA, 16bpp, HexTile | 250 ms      |

### Multiple servers

The implementation is fully thread safe and reentrant; multiple VNC-servers can be started on the same CPU for different layers or displays. If the target (of course the same holds true for the simulation) has multiple displays or multiple layers, this can be a useful option.

### Multiple connections

Multiple to the same layer are possible, given that for each connection a task and a `GUI_VNC_CONTEXT` structure is created.

## 6.8.2 emVNC client

The emVNC client is part of the emWin basic package and can be found in the tools folder as emVNC.exe. It can be used to establish a VNC connection from an MS Windows system to a VNC server. The viewer uses the RFB protocol 3.3. It has been tested with different VNC servers including the emWin VNC server, as well as TightVNC and RealVNC.

### 6.8.2.1 How to connect to a VNC-server

Once emVNC is started, it prompts for typing the network address of a VNC server to connect with:



#### Connecting to a VNC server using the simulation on the same PC

A VNC server running on the local host can be accessed by entering:

`localhost`

Alternatively connecting to `localhost` could be done by hitting the <RETURN> key or by pressing the "Connect" button while the text control is left empty.

#### Connecting to a VNC server running on a different PC or the target

In order to connect to a system in the network the IP address or the name has to be entered:

`192.168.1.14` or `Paul02`

Additionally the server index can be specified in order to connect to a certain server:

`192.168.1.14:1` or `Paul02:1`

#### Screenshot

The following screenshots show the viewer:

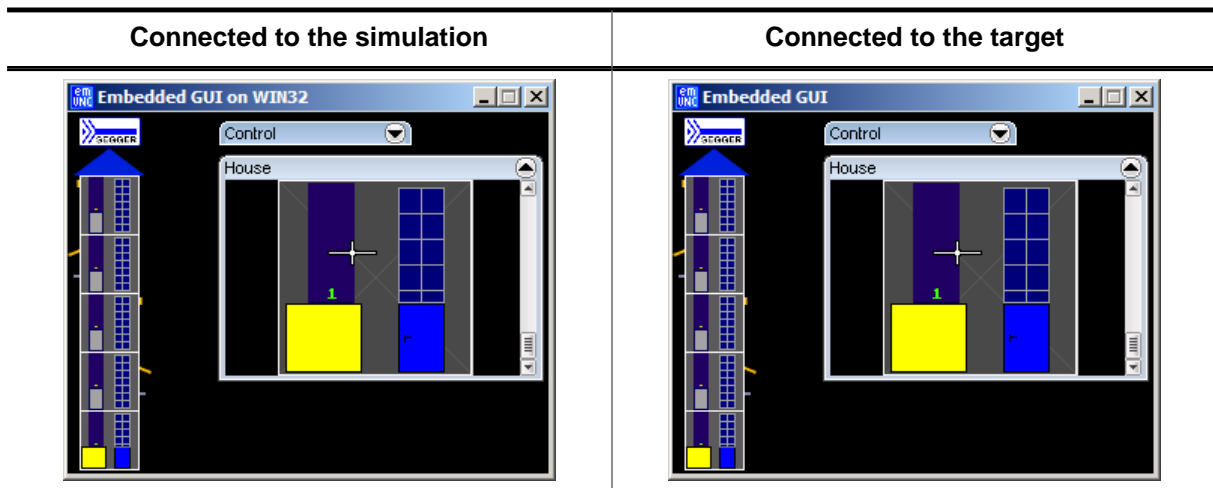

### 6.8.2.2 Opening the file transfer dialog

To spare a constantly visible menu bar in the VNC client, we added the menu option for opening the file transfer dialog to the system menu:

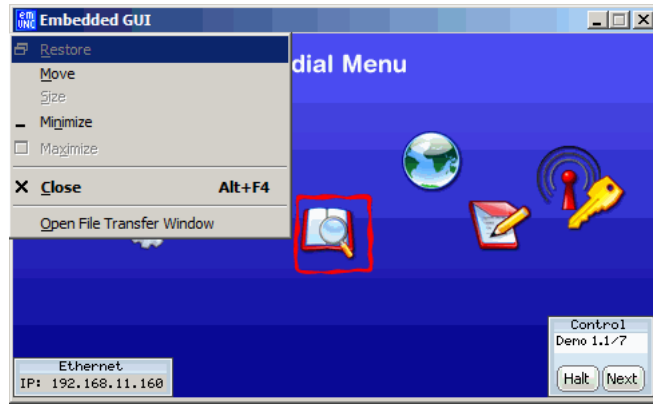

The system menu could be opened by a clicking on the upper left *emVNC* symbol or by the keyboard shortcut <ALT>+<SPACE>.

**Note**

The menu option 'Open file transfer window' is only available if the connected server has been started with file transfer support.

**6.8.2.3 The file transfer window**

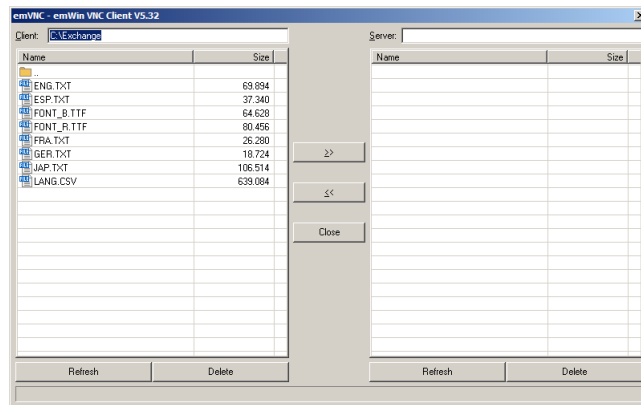

The above shown file transfer window is divided into a server- and a client side. It shows the content of the currently selected directories of both sides. The following operations are available:

**Selecting (multiple) files**

Single clicking multiple files during <STRG> is pressed or moving the cursor with <UP> or <DOWN> to the desired file(s) and press <SPACE> while <STRG> is pressed.

**Single file transfer**

Double-clicking a file starts a single transfer to the opposite side.

**Transfer selected files**

The buttons >> and << can be used for starting the transfer from client to server >> or from server to client <<.

**Deleting selected files**

The **Delete** buttons can be used to delete the selected files from server or client.

**Refreshing content**

Pressing the **Refresh** button updates the content.

## Closing the file transfer window

Pressing <ESC> or the **Close** button

### 6.8.2.4 Connecting with a web browser

#### Prerequisites

Additionally to an IP task, a webserver task is also necessary for a browser connection.

The example under `Sample\GUI_X\GUI_VNC_X_StartServer.c` contains an implementation using emNet for the IP and webserver stack and embOS as the operating system. The implementation can be adapted to different operating systems and/or IP stacks.

#### How to connect

Connecting with a web browser via WebSocket is also possible. **noVNC** is a free and open-source client that can be used.

#### Note

Before noVNC can be used with newer Firefox versions, the option `privacy.file_unique_origin` has to be set to `false` under `about:config`.

To connect, simply enter the target IP and the port 80. The path to be used is "websocketify".

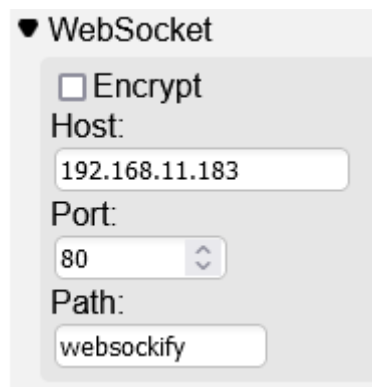

▼ WebSocket

Encrypt

Host:  
192.168.11.183

Port:  
80

Path:  
websocketify

Multiple connections are also possible through the browser, as long as a task and a `GUI_VNC_CONTEXT` structure is created for each desired connection.

## 6.8.3 emWin VNC server

### 6.8.3.1 Starting the emWin VNC server

The one and only thing to start the VNC server is to call the function `GUI_VNC_X_StartServer()`:

```
void MainTask(void) {
    GUI_Init();
    GUI_VNC_X_StartServer(0, // Layer index
                        0); // Server index
    ...
}
```

The above function call creates a thread which listens on port 5900 for an incoming connection. After a connection has been detected `GUI_VNC_Process()` will be called.

#### Ports

The VNC server listens on port 590x, where x is the server index. So for most PC servers, the port will be 5900, because they use display 0 by default.

### 6.8.3.2 Enabling file transfer support

File transfer is enabled by calling `GUI_VNC_X_StartServerFT()` instead of `GUI_VNC_X_StartServer()`. In addition to the task of starting the VNC-thread it sets an API-table containing function pointers for file access. Further it enables the RFB protocol extensions required for file transfers.

### 6.8.3.3 Starting the VNC server in the simulation

The simulation library contains a ready to use implementation of the function `GUI_VNC_X_StartServer()` which simply needs to be called by the application code. It creates a thread which listens on port 590x until an incoming connection is detected and then calls `GUI_VNC_Process()`, which is the implementation of the actual server.

### 6.8.3.4 Example of starting the VNC server on the target system

To be able to use the VNC server on the target it is required to have an implementation of `GUI_VNC_X_StartServer()` or `GUI_VNC_X_StartServerFT()` which works with the available IP library and in case of using file transfer also with the available file system. A ready to use implementation of that function which works with emNet and emFile is available under `Sample\GUI_X\GUI_VNC_X_StartServer.c`.

Since this example does not use dynamic memory allocation to allocate memory for the `GUI_VNC_CONTEXT` structure and task(s), the maximum number of connections has to be specified with the `VNC_MAX_CONNECTIONS` define.

This sample could also be used as starting point for adapting it to other libraries than emNet and emFile. Only small changes should be required in that case.

## 6.8.4 RAM and ROM requirements

#### ROM

About 4.9 KB on ARM7 with hextile encoding, about 3.5 KB without hextile encoding.

#### RAM

The VNC support does not use static data. For each instance one `GUI_VNC_CONTEXT` structure (approx. 60 bytes) is used.



## Others

Each instance needs one TCP/IP socket and one thread.

### 6.8.5 VNC Server API

The following table lists the available VNC-related functions in alphabetical order. Detailed function descriptions follow:

#### Functions

| Routine                                    | Description   |
|--|---|
| <code>GUI_VNC_AttachToLayer()</code>       | Attaches a VNC server to a layer. Without a MultiLayer configuration the given index must be 0.           |
| <code>GUI_VNC_EnableFileTransfer()</code>  | Enables file transfer extension.  |
| <code>GUI_VNC_EnableKeyboardInput()</code> | Enables or disables keyboard input via VNC.   |
| <code>GUI_VNC_GetNumConnections()</code>   | Returns the number of connections to the server.  |
| <code>GUI_VNC_Process()</code>             | The actual VNC server; initializes the communication with the viewer.                                     |
| <code>GUI_VNC_RingBell()</code>            | Rings a bell on the client if it has one.   |
| <code>GUI_VNC_SetFS_API()</code>           | Sets a function table used for file access.   |
| <code>GUI_VNC_SetLockFrame()</code>        | Configures the VNC server not to read the display while the GUI performs drawing operations.              |
| <code>GUI_VNC_SetPassword()</code>         | Sets the password required to connect with the server.  |
| <code>GUI_VNC_SetProgName()</code>         | Sets the text to be shown in the viewers title bar.   |
| <code>GUI_VNC_SetRetryCount()</code>       | Sets the number of additional trials in case of a write error.  |
| <code>GUI_VNC_SetSize()</code>             | Sets the area to be transmitted to the client.  |
| <code>GUI_VNC_X_StartServer()</code>       | Routine to be called to start a thread listening for an incoming connection and executing the VNC server. |
| <code>GUI_VNC_X_StartServerFT()</code>     | Same as above with file transfer support.   |

#### Data structures

| Structure              | Description   |
|------------------------|---|
| <code>IP_FS_API</code> | Table containing the function pointers for file access. |

## 6.8.5.1 Functions

### 6.8.5.1.1 GUI\_VNC\_AttachToLayer()

#### Description

This function attaches the given layer to the VNC server.

#### Prototype

```
void GUI_VNC_AttachToLayer(GUI_VNC_CONTEXT * pContext,  
                           int LayerIndex);
```

#### Parameters

| Parameter               | Description  |
|-------------------------|--|
| <code>pContext</code>   | Pointer to a GUI_VNC_CONTEXT structure.  |
| <code>LayerIndex</code> | Zero-based index of layer to be handled by the server. Normally, with single layer configurations, this parameter should be 0. |

#### Return value

= 0      if the function succeed  
≠ 0      if the function fails.

### 6.8.5.1.2 GUI\_VNC\_EnableFileTransfer()

#### Description

Enables or disables the file transfer extension.

#### Prototype

```
void GUI_VNC_EnableFileTransfer(unsigned OnOff);
```

#### Parameters

| Parameter | Description                                     |
|-----------|---|
| OnOff     | 1 for enabling keyboard input, 0 for disabling. |

#### Return value

= 0      if the function succeeds.  
≠ 0      if the function fails.

#### Additional information

This routine needs to be called by `GUI_VNC_X_StartServerFT()` for enabling file transfer in the protocol. Please also refer to the sample code under `Sample\GUI_X\GUI_VNC_X_StartServer.c` which shows how to enable file transfer on the target.

### 6.8.5.1.3 GUI\_VNC\_EnableKeyboardInput()

#### Description

Enables or disables keyboard input via VNC.

#### Prototype

```
void GUI_VNC_EnableKeyboardInput(int OnOff);
```

#### Parameters

| Parameter | Description                                     |
|-----------|---|
| OnOff     | 1 for enabling keyboard input, 0 for disabling. |

#### 6.8.5.1.4 GUI\_VNC\_GetNumConnections()

##### Description

Returns the number of currently existing connections to the server.

##### Prototype

```
int GUI_VNC_GetNumConnections(void);
```

##### Return value

Number of connections.

### 6.8.5.1.5 GUI\_VNC\_Process()

#### Description

The function sets the send and receive function used to send and receive data and starts the communication with the viewer.

#### Prototype

```
int GUI_VNC_Process(GUI_VNC_CONTEXT * pContext,
                   GUI_tSend       pfSend,
                   GUI_tRecv       pfReceive,
                   void             * pConnectInfo);
```

#### Parameters

| Parameter                 | Description  |
|---------------------------|--|
| <code>pContext</code>     | Pointer to a <code>GUI_VNC_CONTEXT</code> structure.                         |
| <code>pfSend</code>       | Pointer to the function to be used by the server to send data to the viewer. |
| <code>pfReceive</code>    | Pointer to the function to be used by the server to read from the viewer.    |
| <code>pConnectInfo</code> | Pointer to be passed to the send and receive function.                       |

#### Additional information

The `GUI_VNC_CONTEXT` structure is used by the server to store connection state information. The send and receive functions should return the number of bytes successfully send/received to/from the viewer. The pointer `pConnectInfo` is passed to the send and receive routines. It can be used to pass a pointer to a structure containing connection information or to pass a socket number. The following types are used as function pointers to the routines used to send and receive bytes from/to the viewer:

```
typedef int (* GUI_tSend) (const U8 * pData,
                          int         len,
                          void        * pConnectInfo);

typedef int (* GUI_tReceive) (U8 * pData,
                              int   len,
                              void  * pConnectInfo);
```

#### Example

```
static GUI_VNC_CONTEXT _Context; /* Data area for server */
static int _Send(const U8* buf, int len, void * pConnectionInfo) {
    SOCKET Socket = (SOCKET)pConnectionInfo;
    ...
}
static int _Recv(U8* buf, int len, void * pConnectionInfo) {
    SOCKET Socket = (SOCKET)pConnectionInfo;
    ...
}
static void _ServerTask(void) {
    int Socket;
    ...
    GUI_VNC_Process(&_Context, _Send, _Recv, (void *)Socket);
    ...
}
```

### 6.8.5.1.6 GUI\_VNC\_RingBell()

#### Description

Ring a bell on the client if it has one.

#### Prototype

```
void GUI_VNC_RingBell(void);
```

### 6.8.5.1.7 GUI\_VNC\_SetFS\_API()

#### Note

The following description of the `IP_FS_API` structure is an excerpt of the document **UM07001 User & Reference Guide for embOS/IP** which is also available separately on [www.segger.com](http://www.segger.com).

#### Description

Sets a function table used for accessing files.

#### Prototype

```
void GUI_VNC_SetFS_API(const IP_FS_API * pFS_API);
```

#### Parameters

| Parameter            | Description  |
|----------------------|--|
| <code>pFS_API</code> | Pointer to an <code>IP_FS_API</code> structure containing function pointers for file access. |

#### Additional information

This routine needs to be called by `GUI_VNC_X_StartServerFT()` for enabling file transfer in the protocol. Please also refer to the sample code under `Sample\GUI_X\GUI_VNC_X_StartServer.c` which shows how to enable file transfer on the target.



### 6.8.5.1.8 GUI\_VNC\_SetLockFrame()

#### Description

Configures the VNC server not to read the display while the GUI performs drawing operations.

#### Prototype

```
void GUI_VNC_SetLockFrame(unsigned OnOff);
```

#### Parameters

| Parameter | Description   |
|-----------|---|
| OnOff     | If set to a value >0 frame locking will be enabled. Default is enabled frame locking. |

#### Additional information

This can be configured at compile time by using the compile time switch `GUI_VNC_LOCK_FRAME`.

### 6.8.5.1.9 GUI\_VNC\_SetPassword()

#### Description

Sets a password required to connect to the server.

#### Prototype

```
void GUI_VNC_SetPassword(U8 * sPassword);
```

#### Parameters

| Parameter              | Description                                 |
|------------------------|---|
| <code>sPassword</code> | Password required to connect to the server. |

#### Additional information

Per default no password is required. If a password is set the server creates a random challenge of 16 Bytes and encrypts it using DES. The unencrypted challenge is sent to the client and should return encrypted. If the client's response matches the encrypted challenge, authentication was successful.

### 6.8.5.1.10 GUI\_VNC\_SetProgName()

#### Description

Sets the title to be displayed in the title bar of the client window.

#### Prototype

```
void GUI_VNC_SetProgName(const char * sProgName);
```

#### Parameters

| Parameter              | Description  |
|------------------------|--|
| <code>sProgName</code> | Title to be displayed in the title bar of the client window. |

### 6.8.5.1.11 GUI\_VNC\_SetRetryCount()

#### Description

Sets the number of additional trials in case of an error when trying to write data on the line.

#### Prototype

```
void GUI_VNC_SetRetryCount(unsigned Cnt);
```

#### Parameters

| Parameter | Description  |
|-----------|--|
| Cnt       | Number of additional trials to be used in case of an error (default is 0). |

### 6.8.5.1.12 GUI\_VNC\_SetSize()

#### Description

Sets the display size to be transmitted to the client.

#### Prototype

```
void GUI_VNC_SetSize(unsigned xSize,  
                    unsigned ySize);
```

#### Parameters

| Parameter          | Description        |
|--------------------|--------------------|
| <code>xSize</code> | X-size to be used. |
| <code>ySize</code> | Y-size to be used. |

#### Additional information

Per default the server uses the layer size. The size passed to this function can be smaller or larger than the real display.

### 6.8.5.1.13 GUI\_VNC\_X\_StartServer()

#### Description

This function has to start a thread listening for an incoming connection. If a connection is established it has to execute the actual VNC server `GUI_VNC_Process()`. The function has to be supplied by the customer because the implementation depends on the used TCP/IP stack and on the used operating system. The emWin shipment contains an example implementation under `Sample\GUI_X\GUI_VNC_X_StartServer.c`. It could be used as a starting point for adapting it to other systems.

#### Prototype

```
int GUI_VNC_X_StartServer(int LayerIndex,  
                          int ServerIndex);
```

#### Parameters

| Parameter                | Description                      |
|--------------------------|----------------------------------|
| <code>LayerIndex</code>  | Layer to be shown by the viewer. |
| <code>ServerIndex</code> | Server index.                    |

#### Return value

0        OK.  
-1       Error.

#### Additional information

There is no difference to start a VNC server in the simulation or on the target. In both cases you should call this function. The simulation contains an implementation of this function, the hardware implementation has to be done by the customer.

### 6.8.5.1.14 GUI\_VNC\_X\_StartServerFT()

#### Description

Function which has to be implemented by the customer to start the VNC server with file transfer support. Additionally to starting a server thread the function has to enable the file transfer extensions by calling `GUI_VNC_EnableFileTransfer()` and it has to set a function table to be used for file access by `GUI_VNC_SetFS_API()`.

#### Prototype

```
int GUI_VNC_X_StartServerFT(int LayerIndex,  
                           int ServerIndex);
```

#### Parameters

| Parameter                | Description                      |
|--------------------------|----------------------------------|
| <code>LayerIndex</code>  | Layer to be shown by the viewer. |
| <code>ServerIndex</code> | Server index.                    |

#### Return value

Returns 0.

#### Additional information

Under `Sample\GUI_X\GUI_VNC_X_StartServer.c` a sample is available which shows a sample implementation using `embOS/IP` and `emFile`.

## 6.8.5.2 Data structures

### 6.8.5.2.1 IP\_FS\_API

#### Description

Table containing the function pointers for file access.

#### Type definition

```
typedef struct {
    void * (* pfOpenFile)                (const char * sFilename,
                                         const char * sOpenFlags           );
    int    (* pfCloseFile)                (void * hFile           );
    int    (* pfReadAt)                   (void * hFile,
                                         void * pBuffer,
                                         U32    Pos,
                                         U32    NumBytes           );
    long   (* pfGetLen)                   (void * hFile           );
    void   (* pfForEachDirEntry)          (void * pContext,
                                         const char * sDir,
                                         void (* pf) (void * pContext,
                                                       void * pFileEntry));
    void   (* pfGetDirEntryFileName)     (void * pFileEntry,
                                         char * sFileName,
                                         U32    SizeOfBuffer           );
    U32    (* pfGetDirEntryFileSize)     (void * pFileEntry,
                                         U32    * pFileSizeHigh           );
    int    (* pfGetDirEntryFileTime)     (void * pFileEntry           );
    U32    (* pfGetDirEntryAttributes)   (void * pFileEntry           );
    void * (* pfCreate)                   (const char * sFileName           );
    void * (* pfDeleteFile)               (const char * sFilename           );
    int    (* pfRenameFile)               (const char * sOldFilename,
                                         const char * sNewFilename           );
    int    (* pfWriteAt)                  (void * hFile,
                                         void * pBuffer,
                                         U32    Pos,
                                         U32    NumBytes           );
    int    (* pfMKDir)                    (const char * sDirName           );
    int    (* pfRMDir)                    (const char * sDirName           );
    int    (* pfIsFolder)                  (const char * sPath              );
    int    (* pfMove)                     (const char * sOldFilename,
                                         const char * sNewFilename           );
} IP_FS_API;
```

#### Structure members

| Function                                   | Description   |
|--|---|
| Read only file system functions (required) |   |
| <a href="#">pfOpenFile</a>                 | Pointer to a function that creates/opens a file and returns the handle of these file. |
| <a href="#">pfCloseFile</a>                | Pointer to a function that closes a file.   |
| <a href="#">pfReadAt</a>                   | Pointer to a function that reads a file.  |
| <a href="#">pfGetLen</a>                   | Pointer to a function that returns the length of a file.                              |
| Directory query operations                 |   |
| <a href="#">pfForEachDirEntry</a>          | Pointer to a function which is called for each directory entry.                       |
| <a href="#">pfGetDirEntryFileName</a>      | Pointer to a function that returns the name of a file entry.                          |
| <a href="#">pfGetDirEntryFileSize</a>      | Pointer to a function that returns the size of a file.                                |



| Function                                   | Description   |
|--|---|
| <a href="#">pfGetDirEntryFileTime</a>      | Pointer to a function that returns the timestamp of a file.             |
| <a href="#">pfGetDirEntryAttributes</a>    | Pointer to a function that returns the attributes of a directory entry. |
| Write file operations                      |   |
| <a href="#">pfCreate</a>                   | Pointer to a function that creates a file.                              |
| <a href="#">pfDeleteFile</a>               | Pointer to a function that deletes a file.                              |
| <a href="#">pfRenameFile</a>               | Pointer to a function that renames a file.                              |
| <a href="#">pfWriteAt</a>                  | Pointer to a function that writes a file.                               |
| Additional directory operations (optional) |   |
| <a href="#">pfMKDir</a>                    | Pointer to a function that creates a directory.                         |
| <a href="#">pfRMDir</a>                    | Pointer to a function that deletes a directory.                         |
| Additional operations (optional)           |   |
| <a href="#">pfIsFolder</a>                 | Pointer to a function that checks if a path is a folder.                |
| <a href="#">pfMove</a>                     | Pointer to a function that moves a file or directory.                   |

# Chapter 7

## Legacy features

---

The following chapter contains all features of emWin that are considered to be outdated. These features are still supported by emWin, but are not recommended to be used anymore.

- Sprites
- Cursors
- Virtual screens / Virtual pages

# 7.1 Sprites

### Note

When using sprites the background over which they are moved must not be drawn using RLE-compressed or alpha channel bitmaps.

A **sprite** is an image which can be shown above all other graphics on the screen. A sprite preserves the screen area it covers. It can be moved or removed at any time, fully restoring the screen content. Animation by use of multiple images is possible. Sprites are completely independent from all other drawing operations as well as window operations: sprites do not affect drawing or window operations; drawing or window operations do not affect sprites. Sprites can be seen as objects which are sitting "on top" of the screen, similar to cursors.

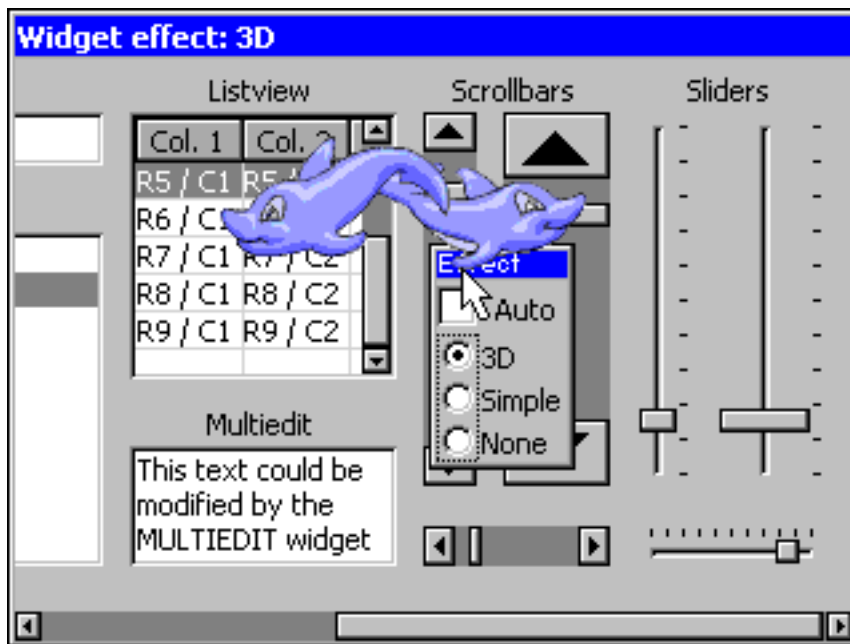

## 7.1.1 Introduction

emWin Sprites are implemented as a pure software solution. No additional hardware is required to use emWin Sprites. They can be shown, moved and deleted without affecting already visible graphics.

### Memory requirements

Each sprite needs a memory area for saving the display data 'behind' the sprite to be able to restore the background on moving operations or on removing the sprite. Further a memory area for a color cache is required. The size of the color cache depends on the number of colors used in the sprite image. So the complete number of bytes required for a sprite can be calculated as follows:

$$\text{SizeOfSpriteObject} \text{ (~30 bytes) } + (\text{XSize} * \text{YSize} + \text{NumberOfBitmapColors}) * \text{REQUIRED\_BYTES\_PER\_PIXEL}$$

### Maximum number of Sprites

The number of simultaneous visible sprites is not limited by emWin. It depends only on the available memory.

## Performance

Note that drawing a sprite is more computer-bound than drawing a simple bitmap, because it has to manage the background data and intersections with other sprites.

## Z-order

Z-order is an ordering of overlapping two-dimensional objects, in this case the sprites. When two sprites overlap, their Z-order determines which one appears on top of the other. The sprite created at last is the topmost sprite.

## 7.1.2 Sprite API

The table below lists the available Sprite-related routines in alphabetical order. Detailed descriptions follow:

| Routine  | Description  |
|--|--|
| <code>GUI_SPRITE_Create()</code>               | Creates a Sprite at the given position in the current layer.           |
| <code>GUI_SPRITE_CreateAnim()</code>           | Creates an animated Sprite at the given position in the current layer. |
| <code>GUI_SPRITE_CreateEx()</code>             | Creates a Sprite at the given position in the desired layer.           |
| <code>GUI_SPRITE_CreateExAnim()</code>         | Creates an animated Sprite at the given position in the current layer. |
| <code>GUI_SPRITE_CreateHidden()</code>         | Creates a hidden Sprite at the given position in the current layer.    |
| <code>GUI_SPRITE_CreateHiddenEx()</code>       | Creates a hidden Sprite at the given position in the given layer.      |
| <code>GUI_SPRITE_Delete()</code>               | Deletes the given Sprite.  |
| <code>GUI_SPRITE_GetState()</code>             | Returns if the given Sprite is visible or not.                         |
| <code>GUI_SPRITE_Hide()</code>                 | Hides the given Sprite.  |
| <code>GUI_SPRITE_SetBitmap()</code>            | Sets a new image for drawing the Sprite.                               |
| <code>GUI_SPRITE_SetBitmapAndPosition()</code> | Sets the position and the image at once.                               |
| <code>GUI_SPRITE_SetLoop()</code>              | Enables/Disables infinite animation of the given Sprite.               |
| <code>GUI_SPRITE_SetPosition()</code>          | Moves the Sprite to the new position.                                  |
| <code>GUI_SPRITE_Show()</code>                 | Shows the given Sprite.  |
| <code>GUI_SPRITE_StartAnim()</code>            | Starts the animation of the given Sprite.                              |
| <code>GUI_SPRITE_StopAnim()</code>             | Stops the animation of the given Sprite.                               |

### 7.1.2.1 GUI\_SPRITE\_Create()

#### Description

Creates a Sprite at the given position in the current layer.

#### Prototype

```
GUI_HSPRITE GUI_SPRITE_Create(const GUI_BITMAP * pBM,
                              int             x,
                              int             y);
```

#### Parameters

| Parameter        | Description  |
|------------------|--|
| <code>pBM</code> | Pointer to a bitmap structure to be used for drawing the Sprite. |
| <code>x</code>   | X-position of the Sprite in screen coordinates.                  |
| <code>y</code>   | Y-position of the Sprite in screen coordinates.                  |

#### Return value

Handle of the new Sprite, 0 on failure.

#### Additional information

The bitmap addressed by the parameter `pBM` needs to agree with the following requirements:

- It should not be compressed.
- It needs to be transparent.
- It needs to be a palette based bitmap with 1, 2, 4 or 8bpp or, if semi transparency is required, a true color bitmap. Other bitmaps or insufficient memory cause the function to fail.

## 7.1.2.2 GUI\_SPRITE\_CreateAnim()

### Description

Creates an animated Sprite at the given position in the current layer.

### Prototype

```
GUI_HSPRITE GUI_SPRITE_CreateAnim(const GUI_BITMAP ** ppBm,
                                   int x,
                                   int y,
                                   unsigned Period,
                                   const unsigned * pPeriod,
                                   int NumItems);
```

### Parameters

| Parameter             | Description   |
|-----------------------|---|
| <code>ppBM</code>     | Pointer to an array of bitmap pointers to be used for drawing the Sprite.           |
| <code>x</code>        | X-position of the Sprite in screen coordinates.                                     |
| <code>y</code>        | Y-position of the Sprite in screen coordinates.                                     |
| <code>Period</code>   | <code>Period</code> to be used to switch between the images.                        |
| <code>pPeriod</code>  | Pointer to an array containing the periods to be used to switch between the images. |
| <code>NumItems</code> | Number of images.   |

### Return value

Handle of the new Sprite, 0 on failure.

### Additional information

The bitmaps addressed by the parameter `ppBM` needs to agree with the following requirements:

- They need to have exactly the same X- and Y-size.
- They should not be compressed.
- They need to be transparent.
- They need to be palette based bitmaps with 1, 2, 4 or 8bpp or, if semi-transparency is required, true color bitmaps. Using bitmaps which do not match above criteria causes the function to fail as well as insufficient memory. The parameter `pPeriod` is required, only if the periods for the images are different. If the same period should be used for all images the parameter `Period` should be used. In this case `pPeriod` can be `NULL`. In case `pPeriod` is used, the animation will stop at the according image if one of the timer values is 0.

### 7.1.2.3 GUI\_SPRITE\_CreateEx()

#### Description

Creates a Sprite at the given position in the desired layer.

#### Prototype

```
GUI_HSPRITE GUI_SPRITE_CreateEx(const GUI_BITMAP * pBM,  
                                int x,  
                                int y,  
                                int Layer);
```

#### Parameters

| Parameter             | Description  |
|-----------------------|--|
| <a href="#">pBM</a>   | Pointer to a bitmap structure to be used for drawing the Sprite. |
| <a href="#">x</a>     | X-position of the Sprite in screen coordinates.                  |
| <a href="#">y</a>     | Y-position of the Sprite in screen coordinates.                  |
| <a href="#">Layer</a> | <a href="#">Layer</a> of Sprite.                                 |

#### Return value

Handle of the new Sprite, 0 on failure.

#### Additional information

Additional information can be found under [GUI\\_SPRITE\\_Create\(\)](#).

### 7.1.2.4 GUI\_SPRITE\_CreateExAnim()

#### Description

Creates an animated Sprite at the given position in the current layer.

#### Prototype

```
GUI_HSPRITE GUI_SPRITE_CreateExAnim(const GUI_BITMAP ** ppBm,
                                     int x,
                                     int y,
                                     unsigned Period,
                                     const unsigned * pPeriod,
                                     int NumItems,
                                     int LayerIndex);
```

#### Parameters

| Parameter               | Description  |
|-------------------------|--|
| <code>ppBM</code>       | Pointer to an array of bitmap pointers to be used for drawing the Sprite.      |
| <code>x</code>          | X-position of the Sprite in screen coordinates.                                |
| <code>y</code>          | Y-position of the Sprite in screen coordinates.                                |
| <code>Period</code>     | <code>Period</code> to be used to switch between the images.                   |
| <code>pPeriod</code>    | Pointer to an array containing values to be used to switch between the images. |
| <code>NumItems</code>   | Number of images.  |
| <code>LayerIndex</code> | Layer of Sprite.   |

#### Return value

Handle of the new Sprite, 0 on failure.

#### Additional information

Additional information can be found under `GUI_SPRITE_CreateAnim()`.



### 7.1.2.5 GUI\_SPRITE\_CreateHidden()

#### Description

Creates a hidden Sprite at the given position in the current layer.

#### Prototype

```
GUI_HSPRITE GUI_SPRITE_CreateHidden(const GUI_BITMAP * pBM,  
                                     int x,  
                                     int y);
```

#### Parameters

| Parameter           | Description  |
|---------------------|--|
| <a href="#">pBM</a> | Pointer to a bitmap structure to be used for drawing the Sprite. |
| <a href="#">x</a>   | X-position of the Sprite in screen coordinates.                  |
| <a href="#">y</a>   | Y-position of the Sprite in screen coordinates.                  |

#### Return value

Handle of the new Sprite, 0 on failure.

#### Additional information

More details can be found in the description of `GUI_SPRITE_Create()`.

### 7.1.2.6 GUI\_SPRITE\_CreateHiddenEx()

#### Description

Creates a hidden Sprite at the given position in the given layer.

#### Prototype

```
GUI_HSPRITE GUI_SPRITE_CreateHiddenEx(const GUI_BITMAP * pBM,  
                                       int           x,  
                                       int           y,  
                                       int           Layer);
```

#### Parameters

| Parameter             | Description  |
|-----------------------|--|
| <a href="#">pBM</a>   | Pointer to a bitmap structure to be used for drawing the Sprite. |
| <a href="#">x</a>     | X-position of the Sprite in screen coordinates.                  |
| <a href="#">y</a>     | Y-position of the Sprite in screen coordinates.                  |
| <a href="#">Layer</a> | <a href="#">Layer</a> to be used.                                |

#### Return value

Handle of the new Sprite, 0 on failure.

#### Additional information

More details can be found in the description of [GUI\\_SPRITE\\_Create\(\)](#).

### 7.1.2.7 GUI\_SPRITE\_Delete()

#### Description

Deletes the given Sprite.

#### Prototype

```
void GUI_SPRITE_Delete(GUI_HSPRITE hSprite);
```

#### Parameters

| Parameter            | Description                     |
|----------------------|---------------------------------|
| <code>hSprite</code> | Handle of Sprite to be deleted. |

#### Additional information

The function deletes the Sprite from the memory and restores its background automatically.

### 7.1.2.8 GUI\_SPRITE\_GetState()

#### Description

Returns if the given Sprite is visible or not.

#### Prototype

```
int GUI_SPRITE_GetState(GUI_HSPRITE hSprite);
```

#### Parameters

| Parameter            | Description       |
|----------------------|-------------------|
| <code>hSprite</code> | Handle of Sprite. |

#### Return value

- 1 if the Sprite is visible.
- 0 if not.

### 7.1.2.9 GUI\_SPRITE\_Hide()

#### Description

Hides the given Sprite.

#### Prototype

```
void GUI_SPRITE_Hide(GUI_HSPRITE hSprite);
```

#### Parameters

| Parameter            | Description               |
|----------------------|---------------------------|
| <code>hSprite</code> | Handle of Sprite to hide. |

#### Additional information

The function removes the given Sprite from the list of visible Sprites.

### 7.1.2.10 GUI\_SPRITE\_SetBitmap()

#### Description

Sets a new image for drawing the Sprite.

#### Prototype

```
int GUI_SPRITE_SetBitmap(      GUI_HSPRITE  hSprite,  
                             const GUI_BITMAP * pBM);
```

#### Parameters

| Parameter            | Description  |
|----------------------|--|
| <code>hSprite</code> | Handle of Sprite.  |
| <code>pBM</code>     | Pointer to a bitmap structure to be used for drawing the Sprite. |

#### Return value

0        on success  
1        on error.

#### Additional information

The new bitmap must have exact the same size as the previous one. Passing a pointer to a bitmap of a different size causes the function to fail. The function immediately replaces the visible Sprite image on the screen. No further operation is required for showing the new image.

### 7.1.2.11 GUI\_SPRITE\_SetBitmapAndPosition()

#### Description

Sets the position and the image at once.

#### Prototype

```
int GUI_SPRITE_SetBitmapAndPosition(    GUI_HSPRITE  hSprite,
                                       const GUI_BITMAP * pBM,
                                       int           x,
                                       int           y);
```

#### Parameters

| Parameter            | Description  |
|----------------------|--|
| <code>hSprite</code> | Handle of Sprite.  |
| <code>pBM</code>     | Pointer to the new bitmap structure to be used to draw the Sprite. |
| <code>x</code>       | New X-position in screen coordinates.                              |
| <code>y</code>       | New Y-position in screen coordinates.                              |

#### Return value

0        on success  
1        on error.

#### Additional information

It makes a difference on using the functions `GUI_SPRITE_SetBitmap()` and `GUI_SPRITE_SetPosition()` one after another or using this function. Whereas the image on the screen will be rendered twice on calling `GUI_SPRITE_SetBitmap()` and `GUI_SPRITE_SetPosition()` it is rendered only once on using this function, which can be used very well in animations.

### 7.1.2.12 GUI\_SPRITE\_SetLoop()

#### Description

Enables/Disables infinite animation of the given Sprite.

#### Prototype

```
int GUI_SPRITE_SetLoop(GUI_HSPRITE hSprite,  
                       int          OnOff);
```

#### Parameters

| Parameter            | Description                                      |
|----------------------|--|
| <code>hSprite</code> | Handle of the Sprite.                            |
| <code>OnOff</code>   | 1 to enable infinite animation. 0 to disable it. |

#### Return value

- 1 if the function failed.
- 0 if infinite animation was not previously set.
- 1 if infinite animation was previously set.



### 7.1.2.13 GUI\_SPRITE\_SetPosition()

#### Description

Moves the Sprite to the new position.

#### Prototype

```
void GUI_SPRITE_SetPosition(GUI_HSPRITE hSprite,  
                           int          x,  
                           int          y);
```

#### Parameters

| Parameter            | Description                           |
|----------------------|---------------------------------------|
| <code>hSprite</code> | Handle of Sprite.                     |
| <code>x</code>       | New X-position in screen coordinates. |
| <code>y</code>       | New Y-position in screen coordinates. |

#### Additional information

The function moves the given Sprite to the new position.

### 7.1.2.14 GUI\_SPRITE\_Show()

#### Description

Shows the given Sprite.

#### Prototype

```
void GUI_SPRITE_Show(GUI_HSPRITE hSprite);
```

#### Parameters

| Parameter            | Description       |
|----------------------|-------------------|
| <code>hSprite</code> | Handle of Sprite. |

#### Additional information

The function adds the given Sprite to the list of visible Sprites.

### 7.1.2.15 GUI\_SPRITE\_StartAnim()

#### Description

Starts the animation of the given Sprite.

#### Prototype

```
int GUI_SPRITE_StartAnim(GUI_HSPRITE hSprite);
```

#### Parameters

| Parameter            | Description       |
|----------------------|-------------------|
| <code>hSprite</code> | Handle of Sprite. |

#### Return value

0        on success  
1        on error.

### 7.1.2.16 GUI\_SPRITE\_StopAnim()

#### Description

Stops the animation of the given Sprite.

#### Prototype

```
int GUI_SPRITE_StopAnim(GUI_HSPRITE hSprite);
```

#### Parameters

| Parameter            | Description       |
|----------------------|-------------------|
| <code>hSprite</code> | Handle of Sprite. |

#### Return value

0        on success  
1        on error.

## 7.2 Cursors













### Note

When using cursors the background over which they are moved must not be drawn using RLE-compressed or alpha channel bitmaps.

emWin includes a system-wide cursor which may be changed to other, predefined styles. Also automatically animated cursors are supported. Although the cursor always exists, it is hidden by default. It will not be visible until a call is made to show it, and may be hidden again at any point.

### 7.2.1 Available cursors

The following cursor styles are currently available. If a call to `GUI_CURSOR_Show()` is made and no style is specified with `GUI_CURSOR_Select()`, the default cursor will be a medium arrow.

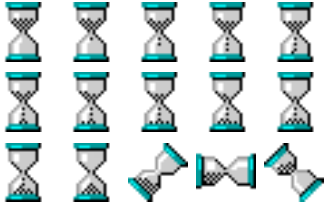
| Arrow cursors   |  | Cross cursors                              |   |
|---|--|--|---|
| GUI_CursorArrowS<br>Small arrow                       |     | GUI_CursorCrossS<br>Small cross            |    |
| GUI_CursorArrowM<br>Medium arrow<br>(default cursor)  |    | GUI_CursorCrossM<br>Medium cross           |   |
| GUI_CursorArrowL<br>Large arrow                       |   | GUI_CursorCrossL<br>Large cross            |  |
| Inverted arrow cursors                                |  | Inverted cross cursors                     |   |
| GUI_CursorArrowSI<br>Small inverted arrow             |   | GUI_CursorCrossSI<br>Small inverted cross  |  |
| GUI_CursorArrowMI<br>Medium inverted arrow            |   | GUI_CursorCrossMI<br>Medium inverted cross |  |
| GUI_CursorArrowLI<br>Large inverted arrow             |   | GUI_CursorCrossLI<br>Large inverted cross  |  |
| Animated cursors                                      |  |  |   |
| GUI_CursorAnimHourglassM<br>Medium animated hourglass |  |  |   |

## 7.2.2 Cursor API

The table below lists the available cursor-related routines in alphabetical order. Detailed descriptions follow:

### Functions

| Routine                                  | Description  |
|--|--|
| <a href="#">GUI_CURSOR_GetState()</a>    | Returns if the cursor is currently visible or not. |
| <a href="#">GUI_CURSOR_Hide()</a>        | Hides the cursor.                                  |
| <a href="#">GUI_CURSOR_Select()</a>      | Sets a specified cursor style.                     |
| <a href="#">GUI_CURSOR_SelectAnim()</a>  | Sets an animated cursor.                           |
| <a href="#">GUI_CURSOR_SetPosition()</a> | Sets the cursor position.                          |
| <a href="#">GUI_CURSOR_Show()</a>        | Shows the cursor.                                  |

### Data structures

| Structure                       | Description  |
|---------------------------------|--|
| <a href="#">GUI_CURSOR_ANIM</a> | Structure that stores information about a cursor animation used by <a href="#">GUI_CURSOR_SelectAnim()</a> . |

## 7.2.2.1 Functions

### 7.2.2.1.1 GUI\_CURSOR\_GetState()

#### Description

Returns if the cursor is currently visible or not.

#### Prototype

```
int GUI_CURSOR_GetState(void);
```

#### Return value

|   |                           |
|---|---------------------------|
| 1 | if the cursor is visible. |
| 0 | if not.                   |

### 7.2.2.1.2 GUI\_CURSOR\_Hide()

#### Description

Hides the cursor.

#### Prototype

```
void GUI_CURSOR_Hide(void);
```

#### Additional information

This is the default cursor setting. If the cursor should be visible, the function `GUI_CURSOR_Show()` needs to be called.



### 7.2.2.1.3 GUI\_CURSOR\_Select()

#### Description

Sets a specified cursor style.

#### Prototype

```
GUI_CURSOR *GUI_CURSOR_Select(const GUI_CURSOR * pCursor);
```

#### Parameters

| Parameter            | Description                           |
|----------------------|---------------------------------------|
| <code>pCursor</code> | Pointer to the cursor to be selected. |

| Permitted values for parameter <code>pCursor</code><br>(Predefined cursors) |                        |
|---|------------------------|
| <code>GUI_CursorArrowS</code>   | Small arrow.           |
| <code>GUI_CursorArrowM</code>   | Medium arrow.          |
| <code>GUI_CursorArrowL</code>   | Large arrow.           |
| <code>GUI_CursorArrowSI</code>  | Small inverted arrow.  |
| <code>GUI_CursorArrowMI</code>  | Medium inverted arrow. |
| <code>GUI_CursorArrowLI</code>  | Large inverted arrow.  |
| <code>GUI_CursorCrossS</code>   | Small cross.           |
| <code>GUI_CursorCrossM</code>   | Medium cross.          |
| <code>GUI_CursorCrossL</code>   | Large cross.           |
| <code>GUI_CursorCrossSI</code>  | Small inverted cross.  |
| <code>GUI_CursorCrossMI</code>  | Medium inverted cross. |
| <code>GUI_CursorCrossLI</code>  | Large inverted cross.  |

#### Additional information

If this function is not called, the default cursor is a medium arrow.

### 7.2.2.1.4 GUI\_CURSOR\_SelectAnim()

#### Description

Sets an animated cursor.

#### Prototype

```
int GUI_CURSOR_SelectAnim(const GUI_CURSOR_ANIM * pCursorAnim);
```

#### Parameters

| Parameter                | Description  |
|--------------------------|--|
| <code>pCursorAnim</code> | Pointer to a GUI_CURSOR_ANIM structure used for the animation. |

| Permitted values for parameter <code>pCursor</code><br>(Predefined cursors) |                                  |
|---|----------------------------------|
| <code>GUI_CursorAnimHourglassM</code>                                       | Animated hourglass, medium size. |

### 7.2.2.1.5 GUI\_CURSOR\_SetPosition()

#### Description

Sets the cursor position.

#### Prototype

```
void GUI_CURSOR_SetPosition(int xNewPos,  
                             int yNewPos);
```

#### Parameters

| Parameter      | Description               |
|----------------|---------------------------|
| <code>x</code> | X-position of the cursor. |
| <code>y</code> | Y-position of the cursor. |

#### Additional information

Normally this function is called internally by the Window Manager and does not need to be called from the application.

### 7.2.2.1.6 GUI\_CURSOR\_Show()

#### Description

Shows the cursor.

#### Prototype

```
void GUI_CURSOR_Show(void);
```

#### Additional information

The default setting for the cursor is hidden; therefore this function must be called if you want the cursor to be visible.

## 7.2.2.2 Data structures

### 7.2.2.2.1 GUI\_CURSOR\_ANIM

#### Description

Structure that stores information about a cursor animation used by `GUI_CURSOR_SelectAnim()`.

#### Type definition

```
typedef struct {
    const GUI_BITMAP ** ppBm;
    int xHot;
    int yHot;
    unsigned Period;
    const unsigned * pPeriod;
    int NumItems;
} GUI_CURSOR_ANIM;
```

#### Structure members

| Member                | Description   |
|-----------------------|---|
| <code>ppBm</code>     | Pointer to an array of pointers to bitmaps to be used for the animated cursor.      |
| <code>xHot</code>     | X-position of hot spot. Details can be found below.                                 |
| <code>yHot</code>     | Y-position of hot spot. Details can be found below.                                 |
| <code>Period</code>   | <code>Period</code> to be used to switch between the images.                        |
| <code>pPeriod</code>  | Pointer to an array containing the periods to be used to switch between the images. |
| <code>NumItems</code> | Number of images used for the animation.  |

#### Additional information

The bitmaps addressed by `ppBM` need to fulfill with the following requirements:

- They need to have exactly the same X- and Y-size.
- They should not be compressed.
- They need to be transparent.
- They need to be palette based bitmaps with 1, 2, 4 or 8bpp.

Other bitmaps or insufficient memory cause the function to fail.

The `pPeriod` is only required if the periods for the images are different. If the same period should be used for all images `Period` should be used instead of `pPeriod`. In this case `pPeriod` should be `NULL`.

`xHot` and `yHot` determine the hot spot position of the cursor. This means the relative position in X and Y from the upper left corner of the image to the position of the pointer input device.

Customized cursors can be realized by passing a pointer to a custom defined `GUI_CURSOR_ANIM` structure.

### 7.3 Virtual screens / Virtual pages

A virtual screen means a display area greater than the physical size of the display. It requires additional video memory and allows instantaneous switching between different screens even on slow CPUs. The following chapter shows

- the requirements for using virtual screens,
- how to configure emWin
- and how to take advantage of virtual screens.

If a virtual display area is configured, the visible part of the display can be changed by setting the origin.

#### 7.3.1 Introduction

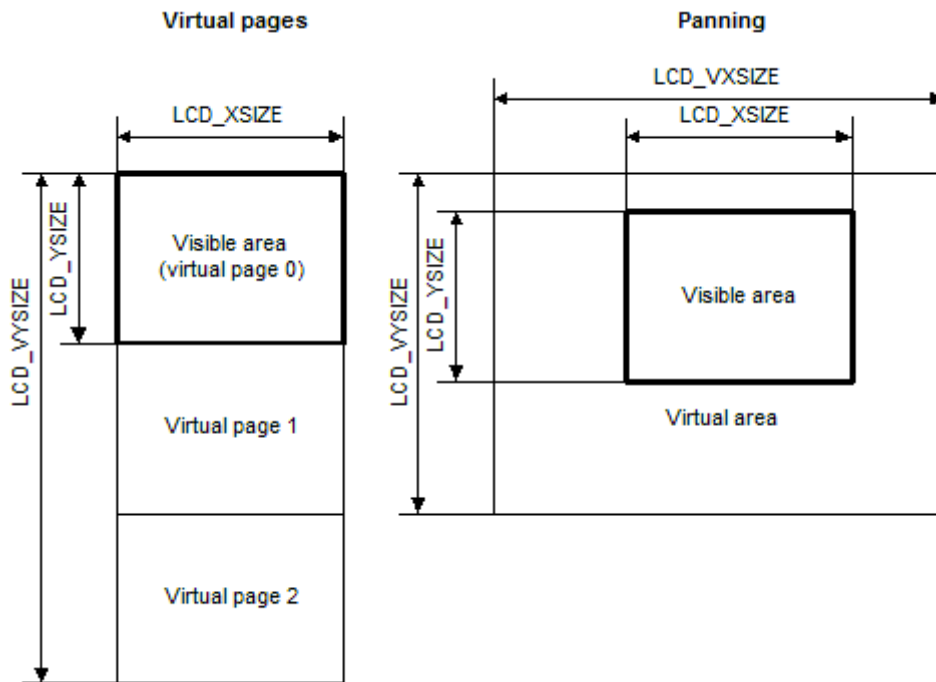

The virtual screen support of emWin can be used for panning or for switching between different video pages.

#### Panning

If the application uses one screen which is larger than the display, the virtual screen API functions can be used to make the desired area visible.

#### Virtual pages

Virtual pages are a way to use the display RAM as multiple pages. If an application for example needs 3 different screens, each screen can use its own page in the display RAM. In this case, the application can draw the second and the third page before they are used. After that the application can switch very fast between the different pages using the virtual screen API functions of emWin. The only thing the functions have to do is setting the right display start address for showing the desired screen. In this case the virtual Y-size typically is a multiple of the display size in Y.

## 7.3.2 Requirements

The virtual screen feature requires hardware with more display RAM than required for a single screen and the ability of the hardware to change the start position of the display output.

### Video RAM

The used display controller should support video RAM for the virtual area. For example if the display has a resolution of 320x240 and a color depth of 16 bits per pixel and 2 screens should be supported, the required size of the video RAM can be calculated as follows:

```
Size = LCD_XSIZE * LCD_YSIZE * LCD_BITSPERPIXEL / 8 * NUM_SCREEN  
Size = 320 * 240 * 16 / 8 * 2  
Size = 307200 Bytes
```

### Configurable display start position

The used display controller needs a configurable display start position. This means the display driver even has a register for setting the frame buffer start address or it has a command to set the upper left display start position.

## 7.3.3 Configuration

Virtual screens should be configured during the initialization. The function `LCD_SetVSize-Ex()` needs to be used to define the virtual display size. Further it is required to react on the command `LCD_X_SETORG` in the driver callback routine by setting the right frame buffer start address.

### 7.3.3.1 LCD\_SetVSizeEx()

#### Description

Sets the size of the virtual display area.

#### Prototype

```
int LCD_SetVSizeEx(int LayerIndex,  
                  int xSize,  
                  int ySize);
```

#### Parameters

| Parameter                  | Description  |
|----------------------------|--|
| <a href="#">LayerIndex</a> | Layer index.   |
| <a href="#">xSize</a>      | X-Size in pixels of the virtual area of the given layer. |
| <a href="#">ySize</a>      | Y-Size in pixels of the virtual area of the given layer. |

#### Return value

0        on success.  
1        on error.

#### Additional information

The function requires a display driver which is able to manage dynamically changes of the virtual display size. If the display driver does not support this feature the function fails.



## 7.3.4 Examples

In the following a few examples are shown to make clear how to use virtual screens with emWin.

### 7.3.4.1 Basic example

The following example shows how to use a virtual screen of 128x192 and a display of 128x64 for instantaneous switching between 3 different screens.

#### Configuration







```
LCD_SetSizeEx (0, 128, 64);
LCD_SetVSizeEx(0, 128, 192);
```

#### Application

```
GUI_SetColor(GUI_RED);
GUI_FillRect(0, 0, 127, 63);
GUI_SetColor(GUI_GREEN);
GUI_FillRect(0, 64, 127, 127);
GUI_SetColor(GUI_BLUE);
GUI_FillRect(0, 128, 127, 191);
GUI_SetColor(GUI_WHITE);
GUI_SetTextMode(GUI_TM_TRANS);
GUI_DispStringAt("Screen 0", 0, 0);
GUI_DispStringAt("Screen 1", 0, 64);
GUI_DispStringAt("Screen 2", 0, 128);
GUI_SetOrg(0, 64); /* Set origin to screen 1 */
GUI_SetOrg(0, 128); /* Set origin to screen 2 */
```

#### Output

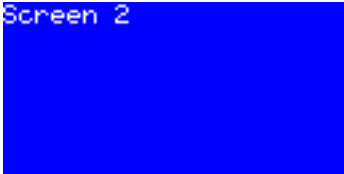
The table below shows the output of the display:

| Description                           | Display output  | Contents of virtual area  |
|---------------------------------------|---|---|
| Before executing<br>GUI_SetOrg(0, 64) |  |  |
| After executing<br>GUI_SetOrg(0, 64)  |  |  |
| After executing<br>GUI_SetOrg(0, 128) |  |  |

### 7.3.4.2 Real time example using the Window Manager

The shipment of emWin contains an example which shows how to use virtual screens in a real time application. It can be found under `Sample\Tutorial\VSCREEN_RealTime.c`:

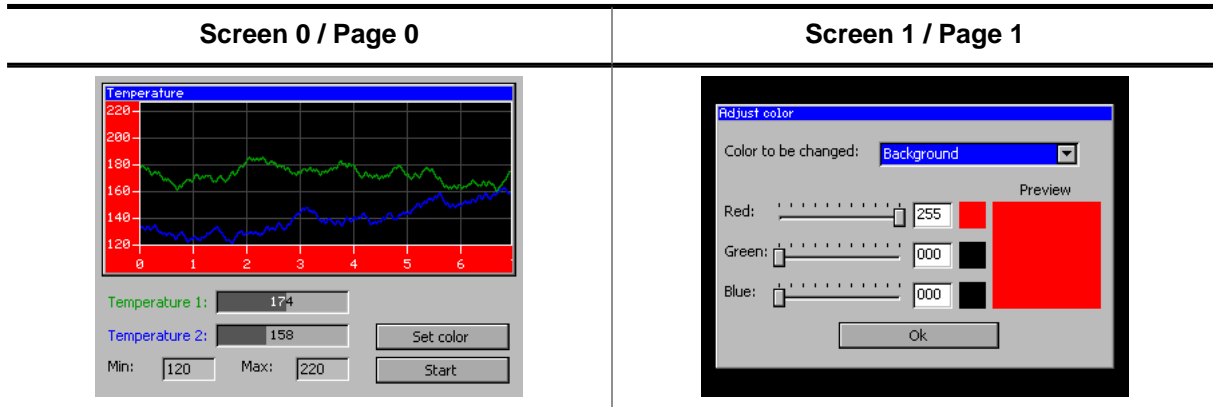

After showing a short introduction, the example creates 2 screens on 2 separate pages as shown above. The first screen shows a dialog which includes a graphical representation of 2 temperature curves. When pressing the "Set color" button, the application switches instantaneously to the second screen, even on slow CPUs. After pressing the "OK" button of the "Adjust color" dialog, the application switches back to the first screen. For more details, see the source code of the example.

#### Viewer Screenshot of the above example

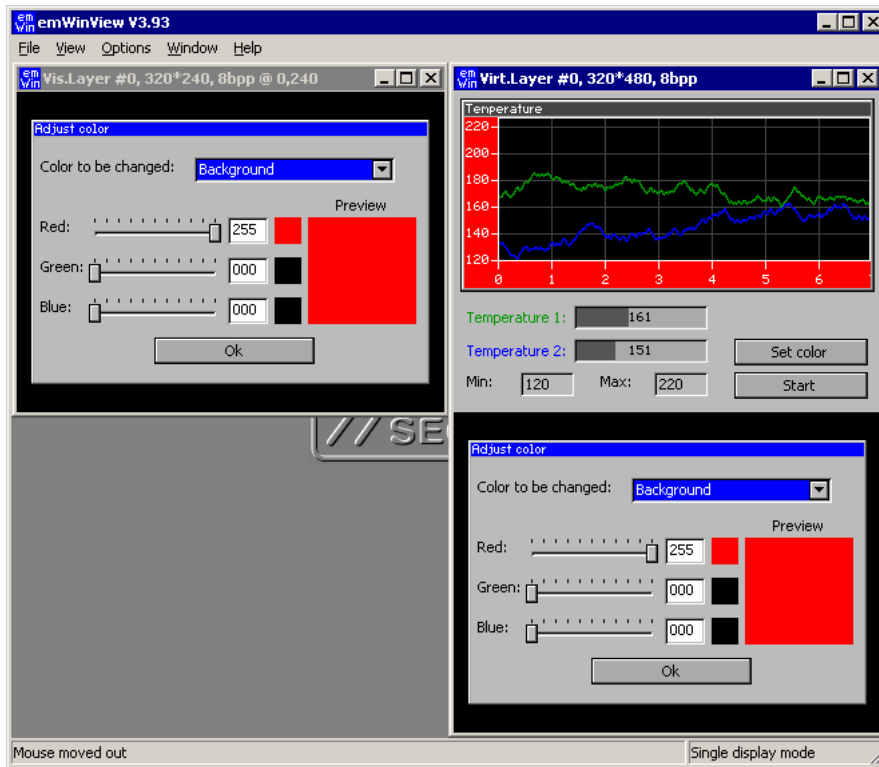

If using the viewer both screens can be shown at the same time. The screenshot above shows the visible display at the left side and the contents of the whole configured virtual display RAM at the right side.

### 7.3.4.3 Dialog example using the Window Manager

The second advanced example is available in the folder Sample/GUI/vSCREEN\_MultiPage. It uses the virtual screen to show 4 screens on 3 different video pages. The application consists of the following screens:

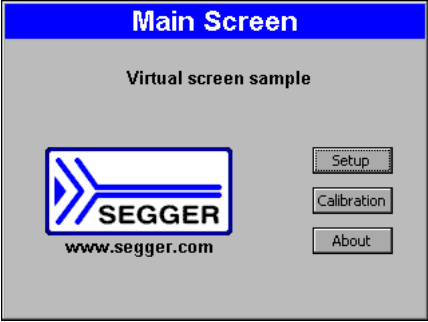
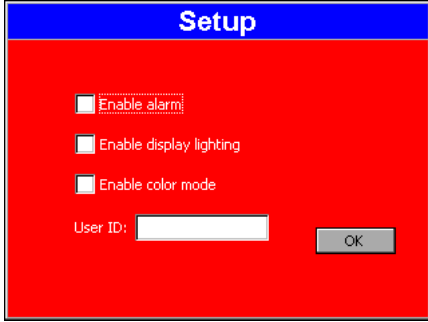
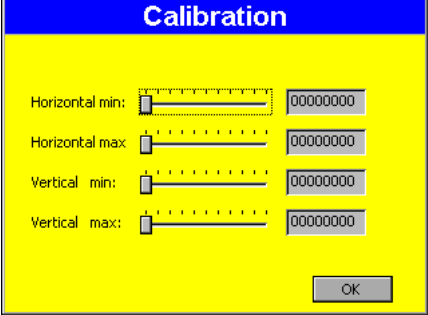
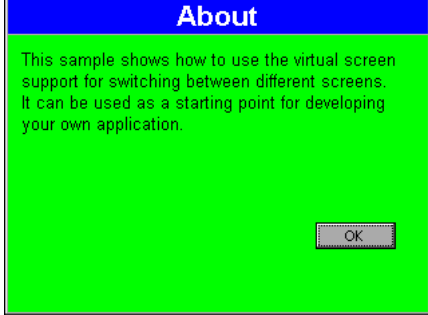
| Main screen / Page 0   | Setup screen / Page 1   |
|--|---|
|   |   |
| Calibration screen / Page 2  | About screen / Page 2   |
|  |  |

After a short intro screen the "Main Screen" is shown on the display using page 0. After the "Setup" button is pressed, the "Setup" screen is created on page 1. After the screen has been created, the application makes the screen visible by switching to page 1. The "Calibration" and the "About" screen both use page 2. If the user presses one of the buttons "Calibration" or "About" the application switches to page 2 and shows the dialog.

#### Viewer Screenshot of the above example

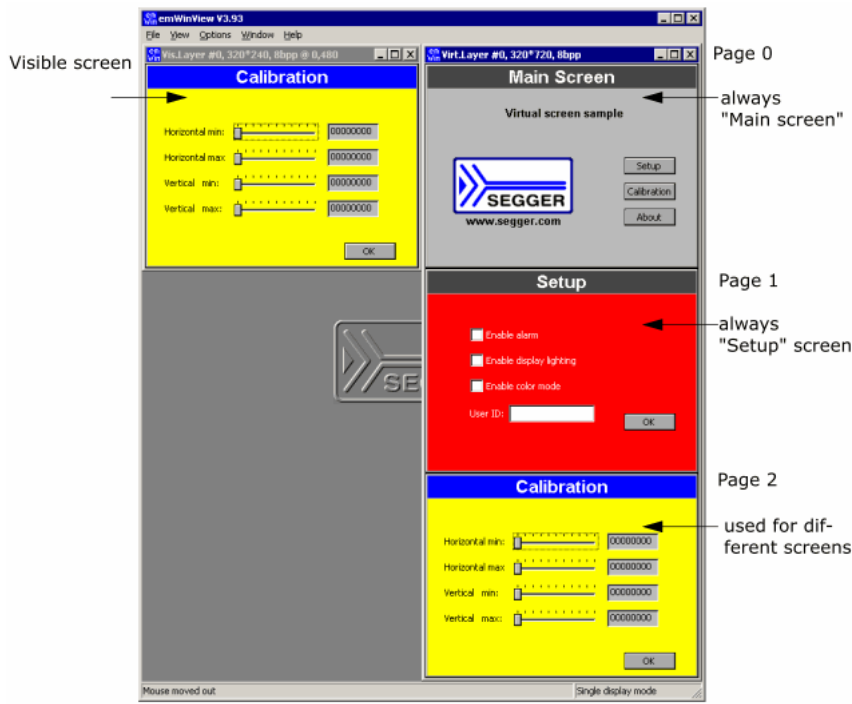

The viewer can show all pages at the same time. The screenshot above shows the visible display at the left side and the contents of the whole layer (virtual display RAM) with the pages 0 - 2 at the right side.

#### 7.3.4.4 Virtual screen API

The following table lists the available routines of the virtual screen support.

| Routine                      | Description                         |
|------------------------------|-------------------------------------|
| <a href="#">GUI_GetOrg()</a> | Returns the display start position. |
| <a href="#">GUI_SetOrg()</a> | Sets the display start position.    |

### 7.3.4.4.1 GUI\_GetOrg()

#### Description

Returns the display start position.

#### Prototype

```
void GUI_GetOrg(int * px,  
               int * py);
```

#### Parameters

| Parameter       | Description  |
|-----------------|--|
| <code>px</code> | Pointer to variable of type int to store the X position of the display start position. |
| <code>py</code> | Pointer to variable of type int to store the Y position of the display start position. |

#### Additional information

The function stores the current display start position into the variables pointed by the given pointers.

### 7.3.4.4.2 GUI\_SetOrg()

#### Description

Sets the display start position.

#### Prototype

```
void GUI_SetOrg(int x,  
               int y);
```

#### Parameters

| Parameter         | Description                                   |
|-------------------|---|
| <a href="#">x</a> | New X position of the display start position. |
| <a href="#">y</a> | New Y position of the display start position. |

# Chapter 8

## Tools

---

The following chapter contains all sub-chapters on the tools supplied with emWin.

- AppWizard
- Viewer
- Bitmap Converter
- Font Converter
- emWinSPY
- GUI Builder

# 8.1 AppWizard

This chapter provides a short overview about what the AppWizard is and some of its features.

To learn more about the AppWizard and how to use it, refer to the document **UM03003 AppWizard User Guide & Reference Manual**.

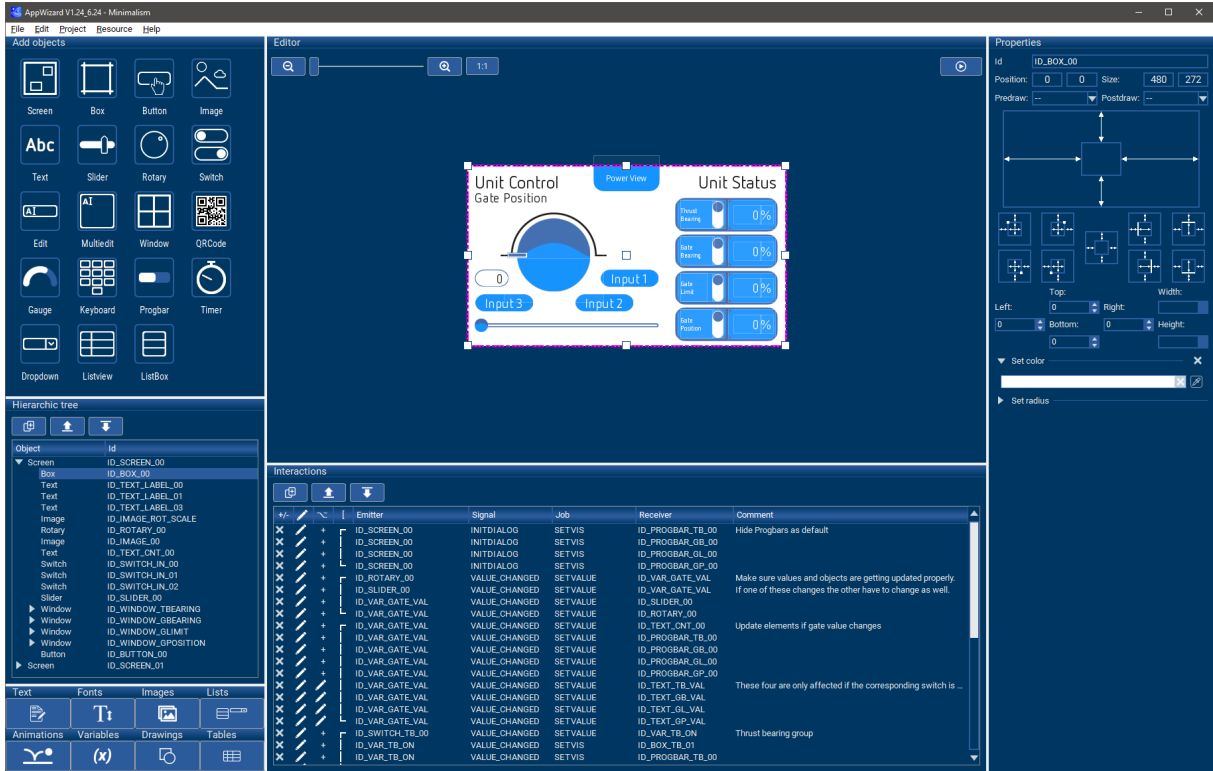



## 8.1.1 About the AppWizard

### What is the AppWizard?

The AppWizard is a tool for creating complete and ready-to-use emWin applications. The tool makes it very easy to build an application, manage resources and even define the application's behavior.

### What You See Is What You Get

The AppWizard tool incorporates the idea of **WYSIWYG** (What You See Is What You Get). This means while the user is building their application with the tool, they simultaneously see the output of their build.

To go along with this motto, testing is made very easy, as it just requires a quick press of the F5 key to enter **Play mode**.

### Define the application's behavior

Interactions are a key part of the AppWizard, they make it very easy to define what the application should do on certain events. For example, when clicking a button, the language of the application is changed or an animation is performed and so on.

Conditions and calculations are also powerful tools for defining the application logic and behavior.

### Custom drawings

Additionally to the many widgets that are usable in AppWizard, the user can also define custom drawings which are displayed in the application.

### Resource management

This tool manages application resources entirely by itself. This means the user does not have to fiddle around with any text, font or image files. When adding images to the AppWizard, all of the converting is done automatically.

Font creation and image conversion can be done comfortably within the tool. No external application is required.

The text manager lets the user easily save the application's texts in different languages, which makes building a multilingual application incredibly easy.

In case of a small addressable ROM area, the tool can also outsource all kinds of resources to an SD card. This does not have to apply for all resource files, it can be done individually for each resource file.

### Target system

The AppWizard's output works with any system having at least 130 KBytes of RAM and 256 KBytes of ROM. The tool comes with predefined BSPs for many target boards. Some of them already contain a ready-to-use emFile system properly configured for the according board which makes it possible to outsource resources to SD card without writing any additional line of code. Please note that for commercial use a license is required.

### Output

The AppWizard generates an application as a bundle of C source and header files. If the user wants to debug their application and, perhaps, add custom defined code, the generated application comes with a simulation project.

## 8.2 emWinView

If you use the simulation when debugging your application, you cannot see the display output when stepping through the source code. The primary purpose of emWinView is to solve this problem. It shows the contents of the simulated layer(s) or display(s) while debugging in the simulation.

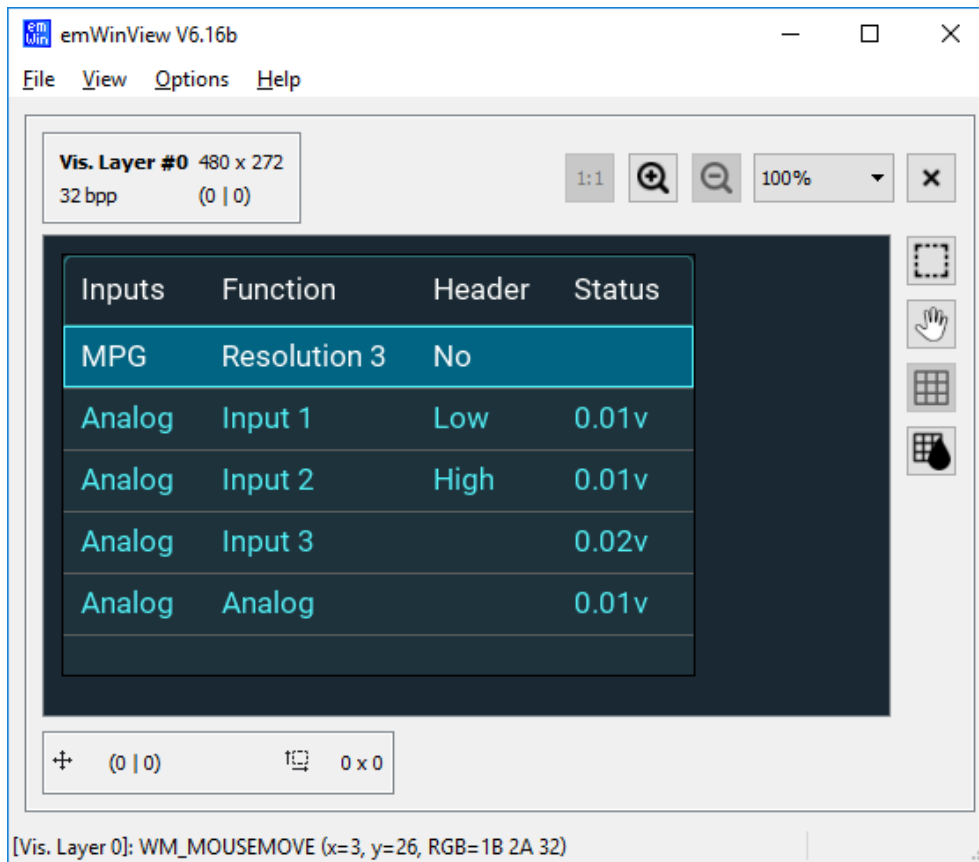

The viewer gives you the following additional capabilities:

- Each layer is shown separately
- Virtual layer is shown as one combined layer
- Composite view for multi-layer configurations
- Color palettes for indexed layers
- Zooming for each layer
- Selection tool for measurement and copying of areas on the layer
- Pixel grid

## 8.2.1 Installation

### Installation

Before the tool can be used, it has to be installed using the wizard that is located in the emWin shipment folder.

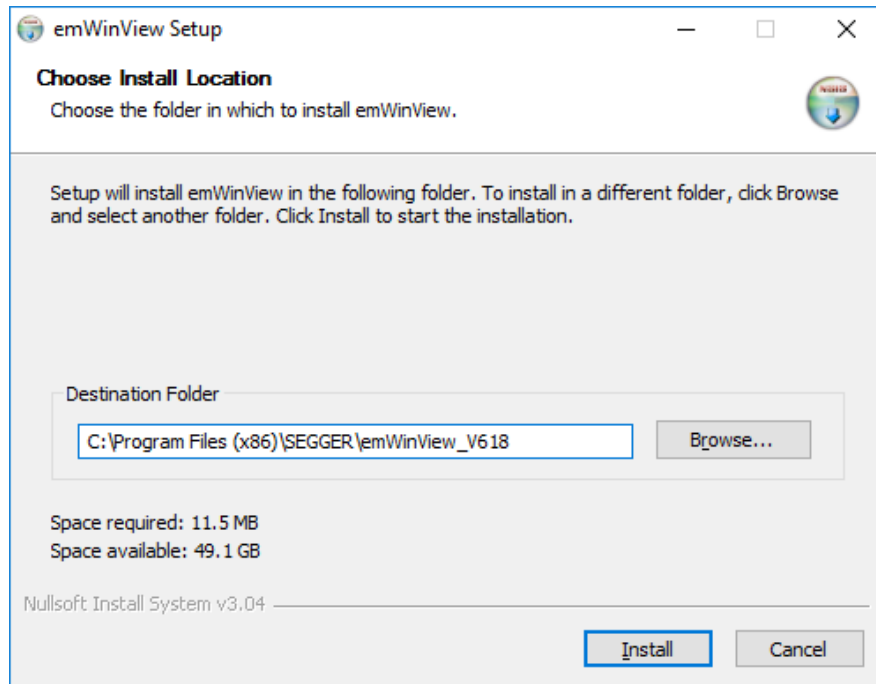

### Uninstallation

To uninstall the tool, simply run the uninstaller located in the installation directory.

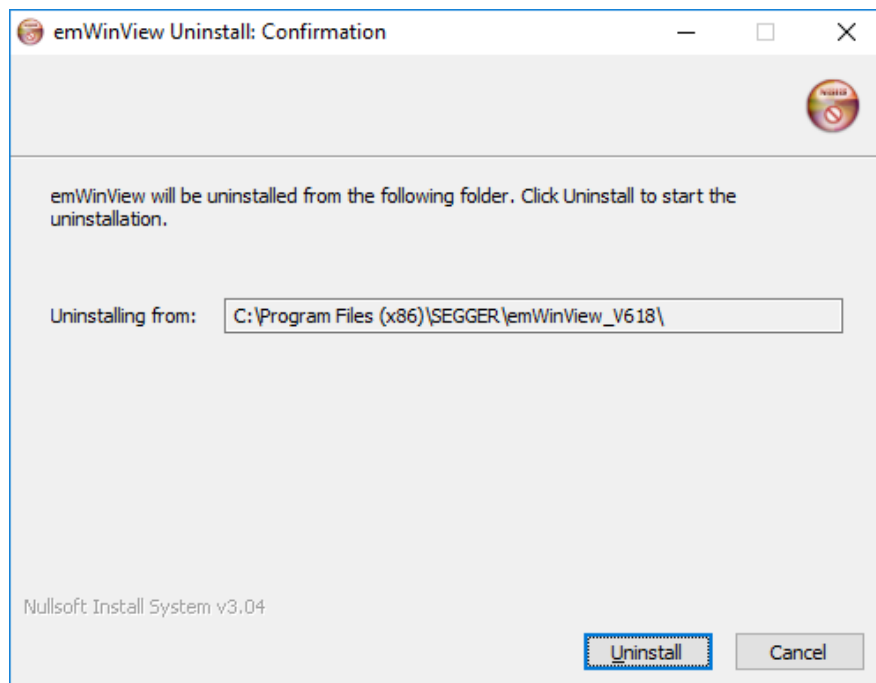

## 8.2.2 Using the simulation and the viewer

If you use the simulation when debugging your application, you cannot see the display output when stepping through the source code. This is due to a limitation of Win32: If one thread (the one being debugged) is halted, all other threads of the process are also halted. This includes the thread which outputs the simulated display on the screen.

The emWin viewer solves this problem by showing the display window and the color window of your simulation in a separate process. It is your choice if you want to start the viewer before debugging your application or while you are debugging. Our suggestion:

- **Step 1:** Start the viewer. No display- or color window is shown until the simulation has been started.
- **Step 2:** Open the Visual Studio workspace.
- **Step 3:** Compile and run the application program.
- **Step 4:** Debug the application as described previously.

The advantage is that you can now follow all drawing operations step by step in the LCD window.

### 8.2.3 Virtual pages

By default the viewer opens one window per layer which shows the visible part of the video RAM, normally the display. If the configured virtual video RAM is larger than the display, the command **View → Virtual Layer → Layer (0...4)** can be used to show the whole video RAM in one window. When using the function `GUI_SetOrg()`, the contents of the visible screen will change, but the virtual layer window remains unchanged:

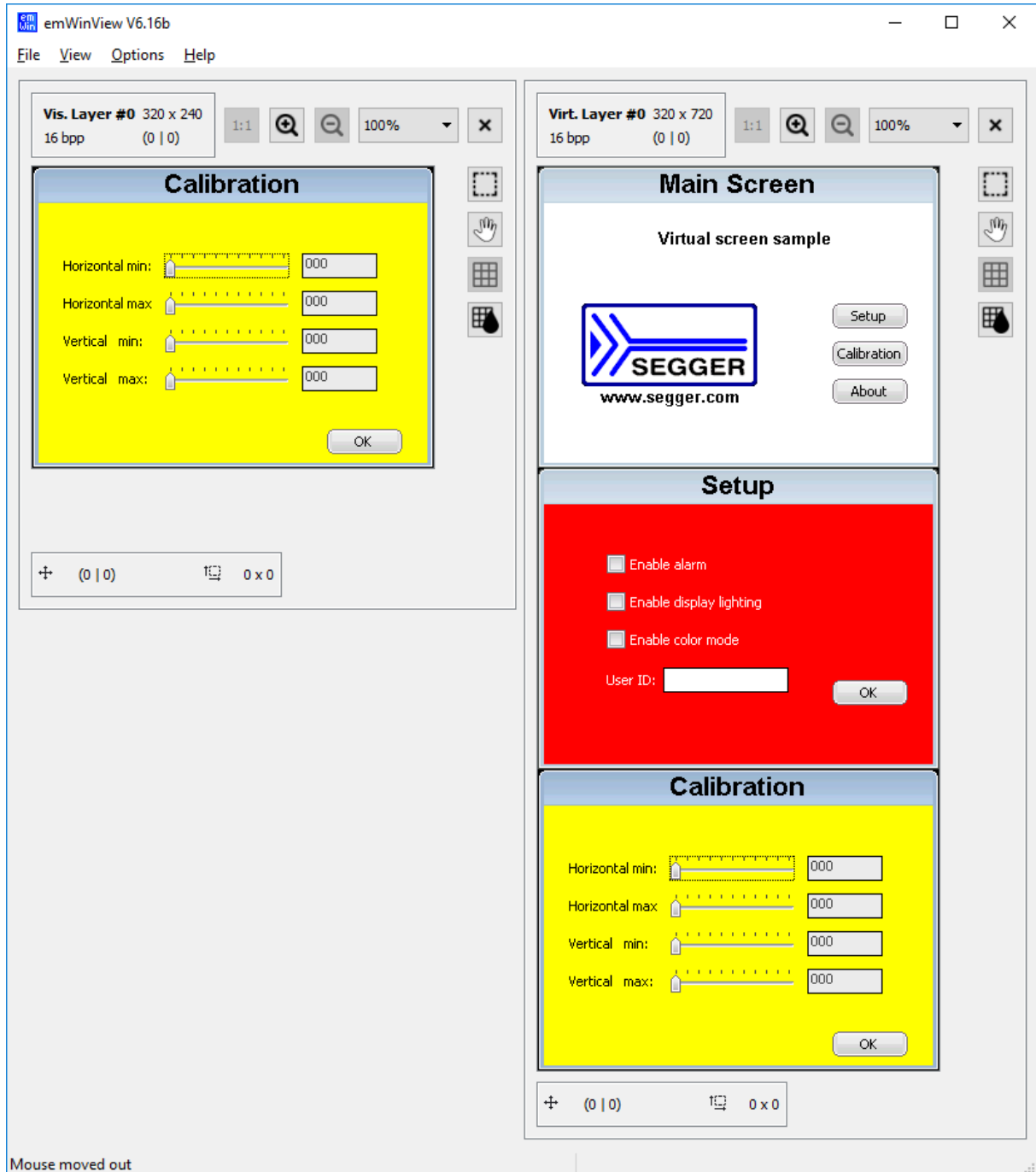

For more information about virtual screens, refer to chapter *Virtual screens / Virtual pages* on page 2786.

### 8.2.4 Multibuffering

If an application uses multiple buffers, the main layer window will always show the front buffer. This means that during debugging, changes to the frame buffer will not be visible until the buffers have been switched.

To see all buffers, the entire video RAM can be opened as a virtual layer. This is done the same way as opening virtual layers, as described above.

## 8.2.5 Multiple displays

If you are working with multiple displays you should set the viewer into 'Multi display mode' by using the command **Options** → **Multi layer/display...** → **Multi display mode**.

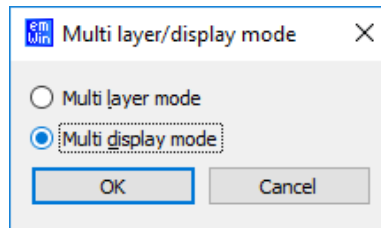

### 8.2.5.1 Multiple layers

If you are working with multiple layers you should set the viewer into 'Multi layer mode' by using the command **Options** → **Multi layer/display...** → **Multi layer mode**.

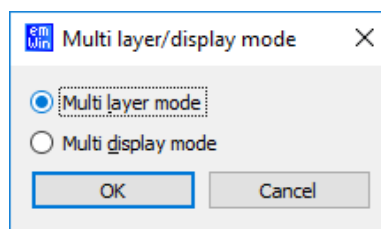

When starting the debugger the viewer will show every single layer and also a composite view of the layers. In order for a composite view to be shown, the composite view has to be enabled by calling `SIM_GUI_SetCompositeSize()` in `SIM_X_Config()`.

### Example

The example below shows a screenshot of the viewer running the "WeatherForecast" demo with two layers configured.

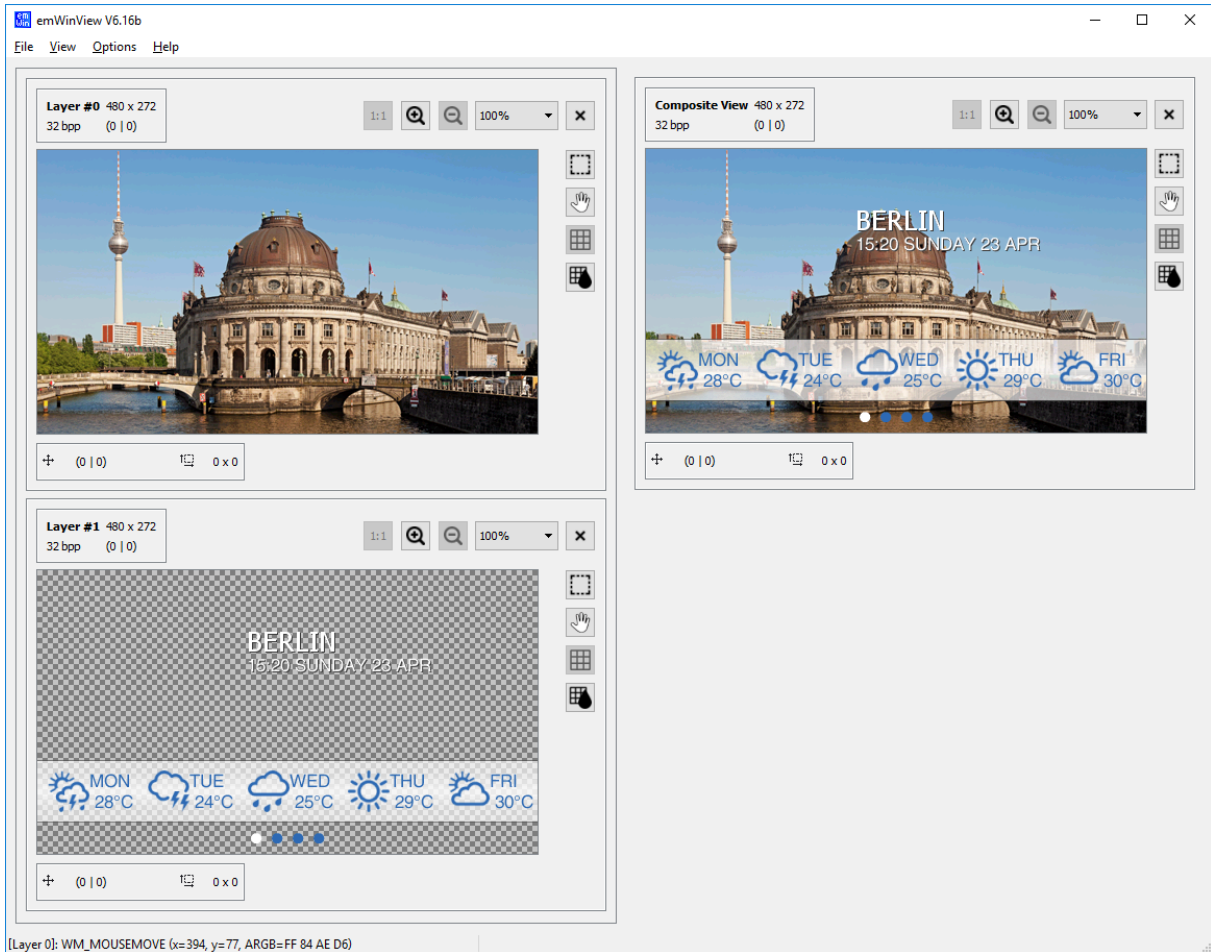

### Transparency

The composite view of the viewer shows all layers; layers with higher index are on top of layers with lower index and can have transparent pixels.

The layer 0 can have transparency, in that case the background color for the composite view is used. This background color can be set using `SIM_GUI_SetCompositeColor()` in `SIM_X_Config()`.

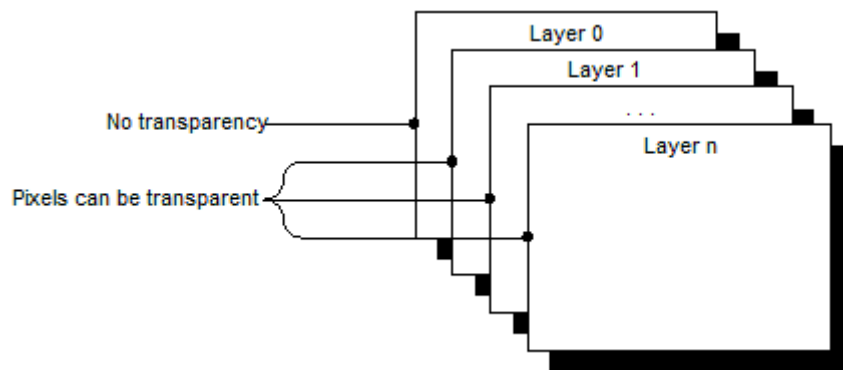

The user can define how transparency should be displayed in emWinView for layers in multi-layer configurations. It can be a gray checkerboard pattern (as seen above) or a custom defined color.



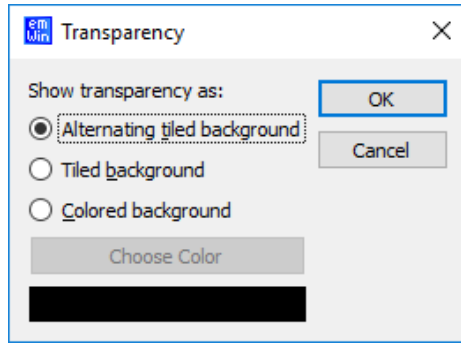

### 8.2.6 Palette-based layers

When the viewer is started, any palette-based layers will automatically show their palette next to them.

The currently selected palette color can also be shown highlighted, this can be read below under *Highlight palette colors* on page 2808.

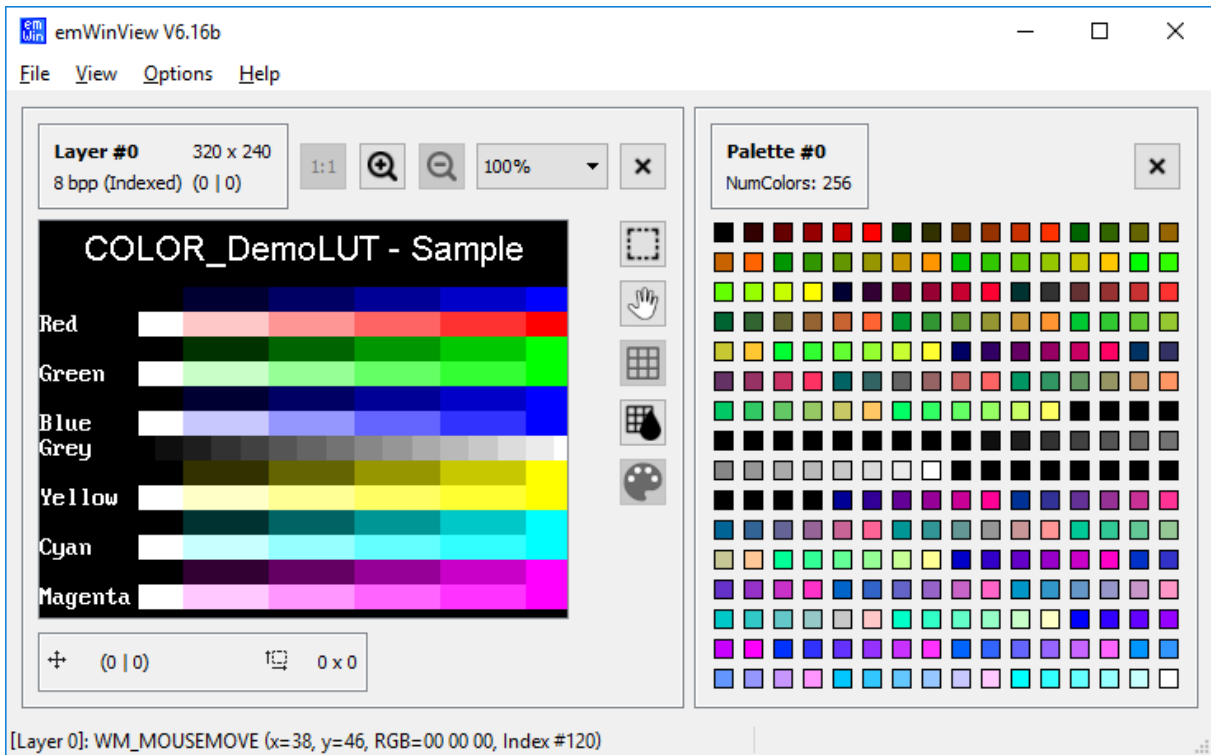

## 8.2.7 Tools

### 8.2.7.1 Selection Tool

 The selection tool can be used to select an area in a layer. This area can be copied to the clipboard by right-clicking the selection.

By default, the selection is highlighted, as shown below. This can be disabled by clicking **Options** → **Highlight selection**.

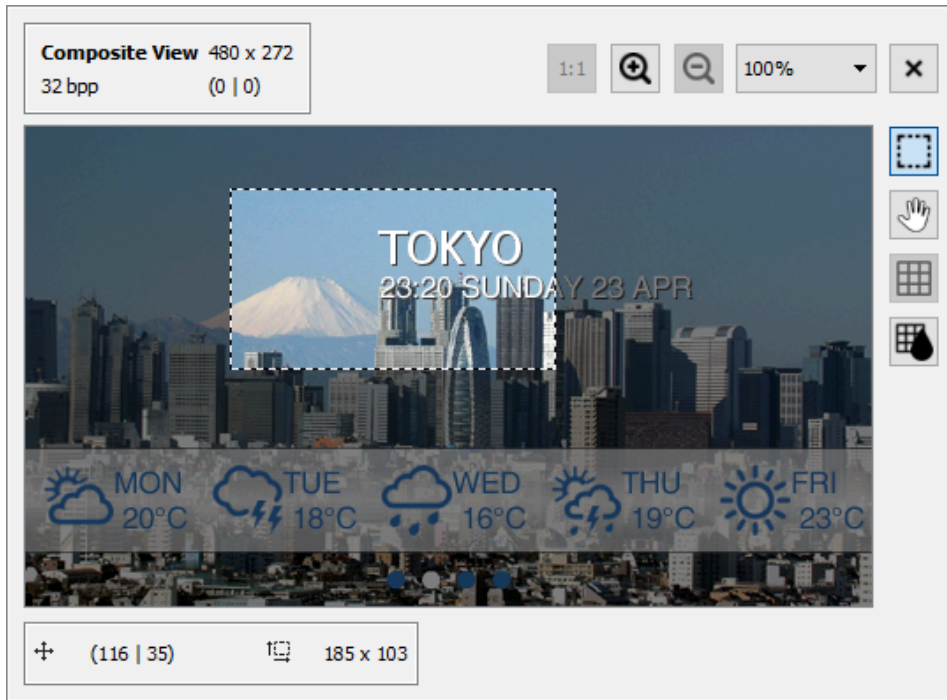

The tool can also be used to measure a distance in a layer. The size and top-left position of the selection rectangle is shown below the layer.

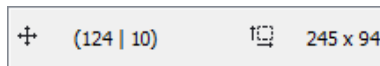

Right-clicking on the selection info below the layer view allows editing of the position and size of the selection rectangle. This can be useful, when the selection should be prepared for copying a specific region of the layer.

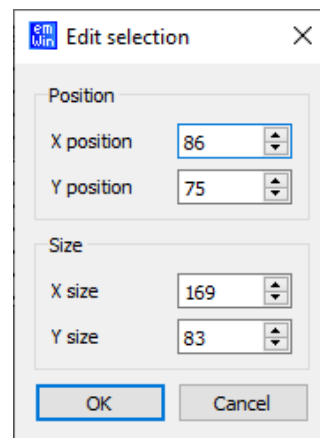
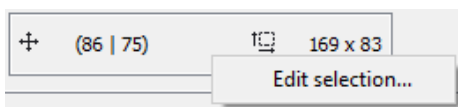

### 8.2.7.2 Hand Tool

 The hand tool allows scrolling through a zoomed layer by clicking and dragging instead of using the mouse wheel.

### 8.2.7.3 Zooming

A layer can be magnified using the zooming tools above the layer. The + and - buttons increase/decrease the zooming level by one.



Increases the zoom level.



Decreases the zoom level.



Resets the zoom level to 100%.

The dropdown allows the selection of a specific zoom level.

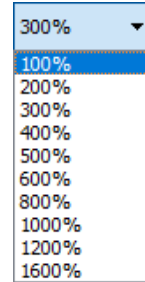
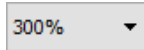

### 8.2.7.4 Grid



The grid can be toggled by clicking the button right to the layer.

This can be done once the zooming level is at 300% or above.



The button below allows the selection of a color for the grid. The selected color is specific to the layer.

Under **Options** → **Grid color...** a default grid color can be selected.

#### XOR grid

Instead of a specific color, the grid can also be drawn inverted to the underlying pixel color (XOR mode). This can be useful when a grid with a single color is not visible due to parts of the layer having the same color.

A XOR grid is always visible, because the color below the grid is inverted. The only exception would be the color 7F7F7F, since inverting this color will result in the same color.

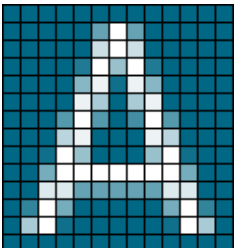
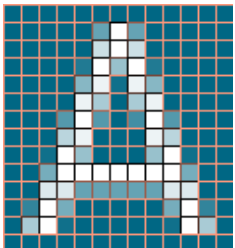
| Grid in black   | Grid in XOR mode   |
|---|--|
|  |  |

## 8.2.8 Options

### 8.2.8.1 Always on top

Per default the viewer window is always on top. You can change this behavior by selecting **Options → Always on top** from the menu.

### 8.2.8.2 Highlight palette colors

When this feature is enabled, hovering over a palette-based layer will show the color in the palette as highlighted. You can enable this by selecting **Options → Highlight palette colors**.

## 8.2.9 Copy to clipboard

### Copy layer image

The contents of a layer or composite view can be copied to the clipboard by right-clicking the layer/view and selecting **Copy to clipboard**.

When a selection has been made and **Copy to clipboard** is clicked, the selected part of the layer will be copied to clipboard.

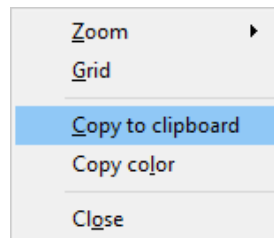

Pressing **CTRL + C** also copies the selected image to clipboard.

### Copy color

When a pixel in a layer is right clicked, selecting **Copy color** will copy the color as an ARGB value to clipboard.

Color and index values of palette colors can also be copied to clipboard.

## 8.2.10 Closing and opening layers

 Layers can be closed by clicking the **X** button in the upper right corner.

They can also be opened and closed via the **View** menu.

## 8.3 Bitmap Converter

The Bitmap Converter is designed for converting common image file formats like BMP, PNG, JPEG or GIF into the desired emWin bitmap format. That can be a C file which can directly be compiled and linked with the project or a binary format, which can be loaded at runtime. Simply load an image into the application. Convert the color format if you want or have to, and save it in the appropriate format.

### Screenshot of the Bitmap Converter

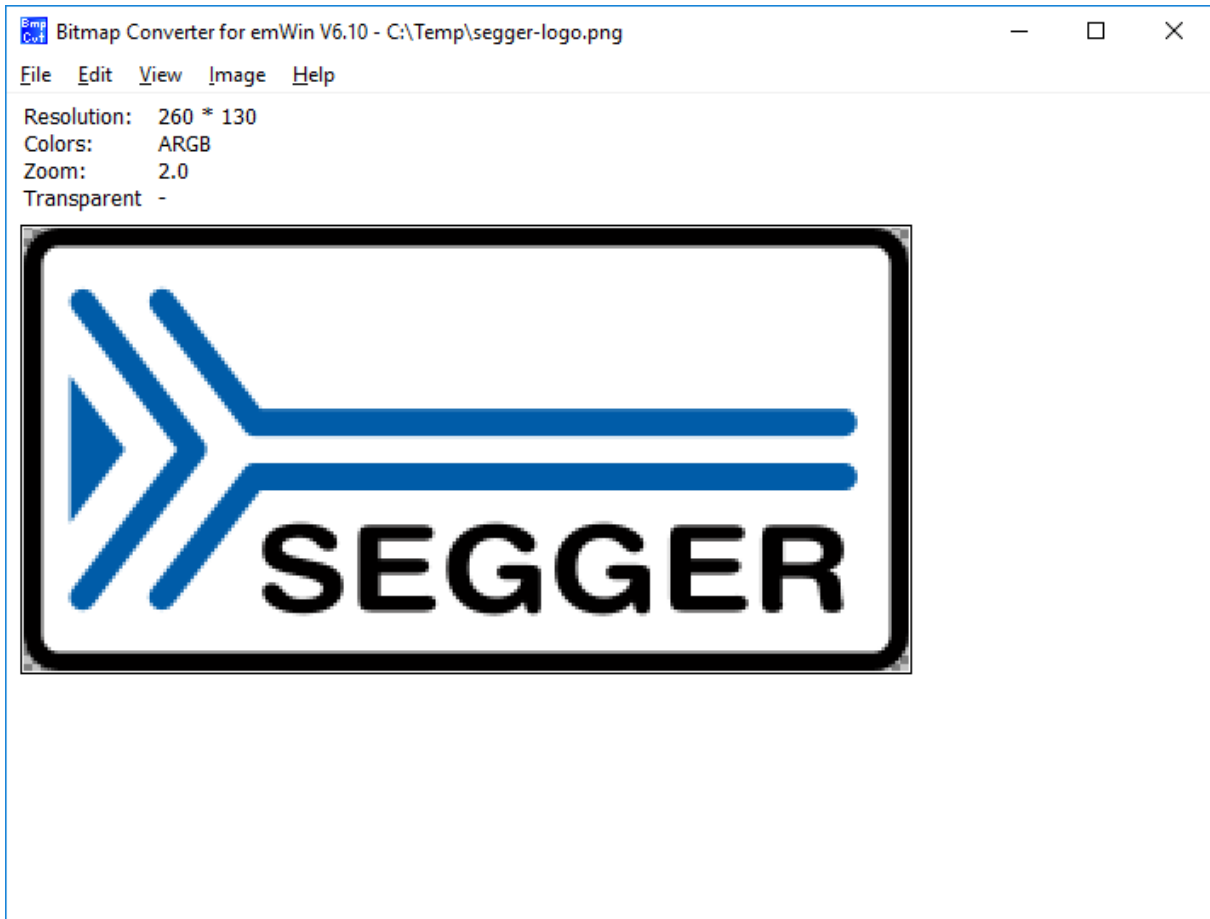

### 8.3.1 What it does

The Bitmap Converter is primarily intended as a tool to convert bitmaps from a PC format to a C file. Bitmaps which can be used with emWin are normally defined as `GUI_BITMAP` structures in C. The structures — or rather the picture data which is referenced by these structures — can be quite large. It makes therefore sense to use the Bitmap Converter to generate C files from bitmaps.

Another useful feature is the ability to save images as C stream files. The advantage against a normal C file is, that these data streams can be located anywhere on any media whereas C files need to be located in the addressable ROM area.

The Bitmap Converter also features color conversion, so that the resulting C code is not unnecessarily large. Typically the number of bits per pixel are reduced to achieve less memory consumption. The tool displays the converted image as well.

A number of simple functions can be performed with the Bitmap Converter, including scaling the size, flipping the bitmap horizontally or vertically, rotating it, and inverting the bitmap indices or colors (these features can be found under the `Image` menu). Any further modifications to an image must be made in a bitmap manipulation program such as Adobe Photoshop or Corel Photopaint. It usually makes the most sense to perform any image modifications in such a program, using the Bitmap Converter for converting purposes only.

## 8.3.2 Loading a bitmap

### 8.3.2.1 Supported input file formats

The Bitmap Converter supports the following file types:

- Windows bitmap files (\*.bmp)
- Graphic Interchange Format (\*.gif)
- Portable Network Graphics (\*.png)
- Joint Photographic Experts Group format (\*.jpeg)
- C bitmaps (\*.c)
- Streamed bitmaps (\*.dta)

#### Windows Bitmap Files (BMP)

The Bitmap Converter supports the most common bitmap file formats. Bitmap files of the following formats can be opened by the Bitmap Converter:

- 1, 4 or 8 bits per pixel (bpp) with palette
- 16, 24 or 32 bpp without palette (full-color mode, in which each color is assigned an RGB value)
- RLE4 and RLE8

Trying to read bitmap files of other formats will cause an error message of the Bitmap Converter.

#### Graphic Interchange Format (GIF)

The Bitmap Converter supports reading GIF files. For general editing only the first image of the GIF file is used. GIF image consisting of several images may be converted to animated sprites and animated cursors.

Transparency and interlaced GIF images are supported by the converter.

#### Portable Network Graphic (PNG)

The PNG format is the most recommended format to create images with alpha blending. The Bitmap Converter supports reading PNG images with alpha channel.

#### Joint Photographic Experts Group (JPEG)

The JPEG format is the most common used format when dealing with photos. JPEG files using a lossy compression method. Because of that they are not the ideal format for diagrams or similar.

The Bitmap Converter supports reading JPEG images.

#### C bitmaps and streamed bitmaps (C and DTA)

The Bitmap Converter supports reading of previously converted bitmaps in both the C and the DTA format.

Despite animated sprites and cursors being also saved as a C file, it is not possible to load these into the Bitmap Converter.

### 8.3.2.2 Loading from a file

An image file of one of the supported formats may be opened directly in the Bitmap Converter by selecting **File → Open**.

### 8.3.2.3 Using the clipboard

Any other type of bitmap (that is, .jpg, .jpeg, .tif) may be opened with another program, copied to the clipboard, and pasted into the Bitmap Converter. This process will achieve the same effect as loading directly from a file.

### 8.3.3 Color conversion

The primary reason for converting the color format of a bitmap is to reduce memory consumption. The most common way of doing this is by using the option **Best palette** as in the above example, which customizes the palette of a particular bitmap to include only the colors which are used in the image. It is especially useful with full-color bitmaps in order to make the palette as small as possible while still fully supporting the image. Once a bitmap file has been opened in the Bitmap Converter, simply select **Image → Convert Into → Best palette** from the menu. If it is necessary to keep transparency select **Image → Convert Into → Best palette + transparency**.

For certain applications, it may be more efficient to use a fixed color palette, chosen from the menu under **Image → Convert Into**. For example, suppose a bitmap in full-color mode is to be shown on a display which supports only four grayscales. It would be a waste of memory to keep the image in the original format, since it would only appear as four grayscales on the display. The full-color bitmap can be converted into a four-grayscale, 2bpp bitmap for maximum efficiency.

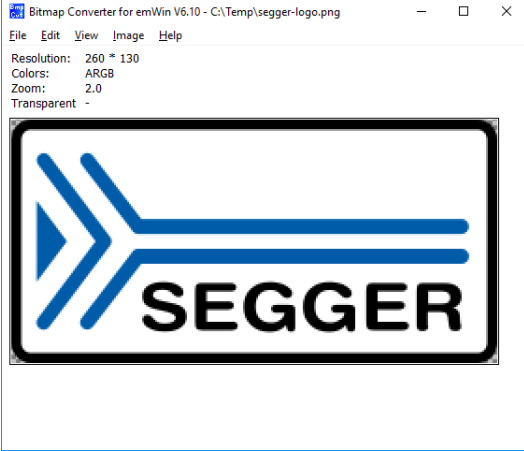
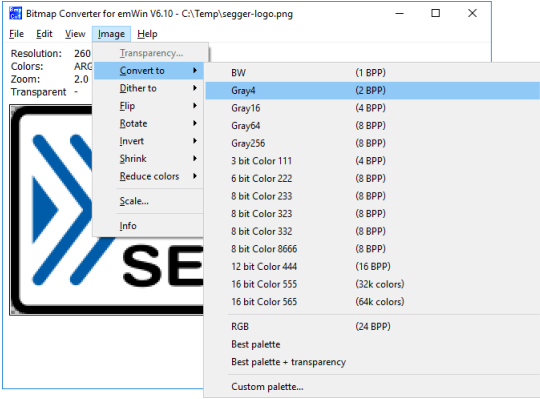
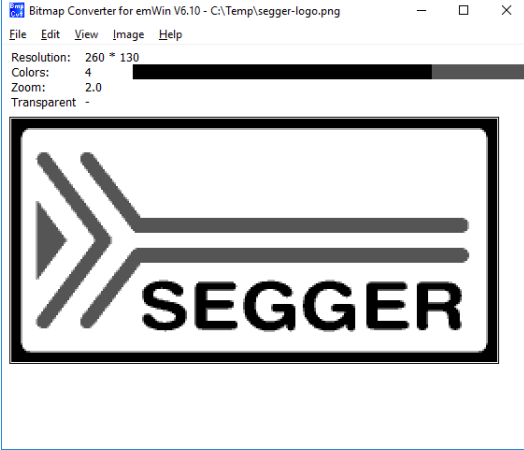

The procedure for conversion would be as follows:

| Step   | Result  |
|--|---|
| <p><b>Step 1: Load the image</b></p> <ul style="list-style-type: none"> <li>The Bitmap Converter is opened and the same file is loaded as in steps 1 and 2 of the example shown in <i>Saving the file</i> on page 2817.</li> <li>The Bitmap Converter displays the loaded bitmap.</li> </ul>                                   |    |
| <p><b>Step 2: Convert the image</b></p> <ul style="list-style-type: none"> <li>Choose <b>Image → Convert Into → Gray4</b></li> </ul>  <ul style="list-style-type: none"> <li>The Bitmap Converter displays the converted bitmap.</li> </ul> |  <ul style="list-style-type: none"> <li>In this example, the image uses less memory since a palette of only 4 grayscales is used instead of the full-color mode. If the target display supports only 4 grayscales, there is no use in having a higher pixel depth as it would only waste memory.</li> </ul> |

### 8.3.4 Dithering

Dithering is a method for showing more details on systems with only a few available colors than with a simple color conversion. It gives the illusion of a better color depth by using

noise to randomize quantization error. If for example a photo needs to be drawn on a b/w system normally not much details would be visible after a simple conversion. However, dithering is able to show much more details:

| Original  | black / white   | black / white, dithered   |
|---|---|---|
|  |  |  |

The above table shows clearly the difference between dithering and a simple conversion. To dither a picture the command **Image → Dither to → ...** should be used:

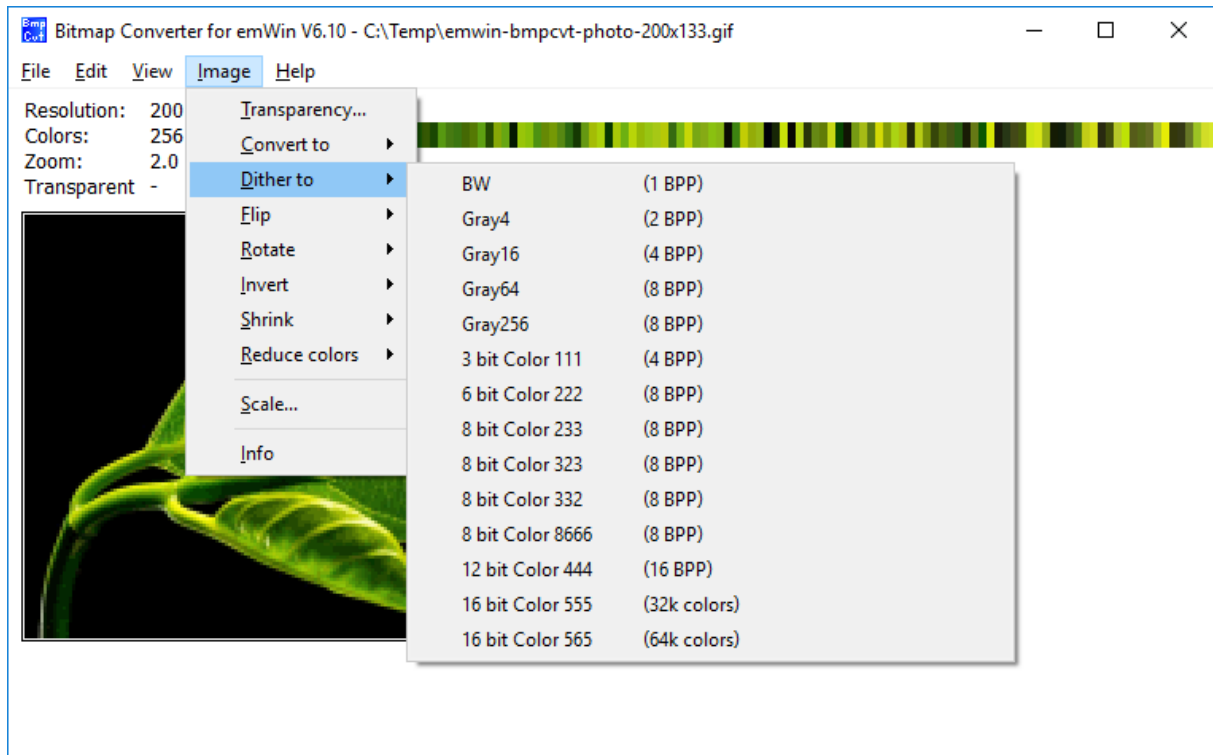

### 8.3.5 Using a custom palette

Converting bitmaps to a custom palette and saving them without palette information can save memory and can increase the performance of bitmap drawing operations.

#### More efficient memory utilization

Per default each bitmap contains its own palette. Even the smallest bitmaps can contain a large palette with up to 256 colors. In many cases only a small fraction of the palette is used by the bitmap. If using many of these bitmaps the amount of memory used by the palettes can grow rapidly.

So it can save much ROM if converting the bitmaps used by emWin to the available hardware palette and saving them as (D)evice (D)ependent (B)itmaps without palette information.

#### Better bitmap drawing performance

Before emWin draws a bitmap, it needs to convert each device independent bitmap palette to the available hardware palette. This is required because the pixel indices of the bitmap file are indices into the device independent bitmap palette and not to the available hardware palette. Converting the bitmap to a DDB means that color conversion at run time is not required and speeds up the drawing.



### 8.3.5.1 Saving a palette file

The Bitmap Converter can save the palette of the currently loaded bitmap into a palette file which can be used for converting other bitmaps with the command **Image → Convert Into → Custom palette**. This requires that the current file is a palette based file and not a RGB file. To save the palette the command **File → Save palette...** can be used.

### 8.3.5.2 Palette file format

Custom palette files are simple files defining the available colors for conversion. They contain the following:

- Header (8 bytes)
- NumColors (U32, 4 bytes)
- 0 (4 bytes)
- U32 Colors[NumColors] (NumColors \* 4 bytes, type GUI\_COLOR)

Total file size is therefore:  $16 + (\text{NumColors} * 4)$  bytes. A custom palette file with 8 colors would be  $16 + (8 * 4) = 48$  bytes. At this point, a binary editor must be used in order to create such a file.

The maximum number of colors supported is 256; the minimum is 2.

#### Example

This example file would define a palette containing 2 colors—red and white:

```
0000: 65 6d 57 69 6e 50 61 6c 02 00 00 00 00 00 00 00
0010: ff 00 00 00 ff ff ff 00
```

The 8 headers make up the first eight bytes of the first line. The U32 is stored lsb first (big endian) and represents the next four bytes, followed by the four 0 bytes. Colors are stored 1 byte per color, where the 4th byte is 0 as follows: RRGGBB00. The second line of code defines the two colors used in this example.

### 8.3.5.3 Palette files for fixed palette modes

Using the custom palette feature can even make sense with the most common used fixed palette modes, not only with custom hardware palettes. For the most palette based fixed palette modes a palette file can be found in the folder `Sample\Palette`.

### 8.3.5.4 Converting a bitmap

The command **Image → Convert Into → Custom palette** should be used for converting the currently loaded bitmap to a custom palette. The Bitmap Converter tries to find the nearest color of the palette file for each pixel of the currently loaded bitmap.

## 8.3.6 Generating C files from bitmaps

The main function of the Bitmap Converter is to convert PC-formatted bitmaps into C files which can be used by emWin. Before doing so, however, it is often desirable to modify the color palette of an image so that the generated C file is not excessively large.

The bitmap may be saved as a bmp, png or a gif file (which can be reloaded and used or loaded into other bitmap manipulation programs) or as a C file. A C file will serve as an input file for your C compiler. It may contain a palette (device-independent bitmap, or DIB) or be saved without (device-dependent bitmap, or DDB). DIBs are recommended, as they will display correctly on any display; a DDB will only display correctly on a display which uses the same palette as the bitmap.

C files may be generated as "C with palette", "C without palette", "C with palette, compressed" or "C without palette, compressed". For more information on compressed files, see the section "Compressed bitmaps" as well as the example at the end of the chapter.

### 8.3.6.1 Supported bitmap formats

The following table shows the currently available output formats for C and C stream files:

| Format   | Color depth [bpp] | Com-pression | Trans-parency | Palette |
|--|-------------------|--------------|---------------|---------|
| 1 bit per pixel  | 1                 | no           | yes           | yes     |
| 2 bits per pixel   | 2                 | no           | yes           | yes     |
| 4 bits per pixel   | 4                 | no           | yes           | yes     |
| 8 bits per pixel   | 8                 | no           | yes           | yes     |
| Compressed, RLE1   | 1                 | yes          | yes           | yes     |
| Compressed, RLE4   | 4                 | yes          | yes           | yes     |
| Compressed, RLE8   | 8                 | yes          | yes           | yes     |
| 12 bits per pixel 444_12   | 12                | no           | no            | no      |
| 12 bits per pixel M444_12, red and blue swapped                            | 12                | no           | no            | no      |
| 12 bits per pixel 444_12_1   | 12                | no           | no            | no      |
| 12 bits per pixel M444_12_1, red and blue swapped                          | 12                | no           | no            | no      |
| 12 bits per pixel 444_16   | 12                | no           | no            | no      |
| 12 bits per pixel M444_16, red and blue swapped                            | 12                | no           | no            | no      |
| High color 555   | 15                | no           | no            | no      |
| High color 555, red and blue swapped                                       | 15                | no           | no            | no      |
| High color 565   | 16                | no           | no            | no      |
| High color 565, red and blue swapped                                       | 16                | no           | no            | no      |
| High color 565, compressed   | 16                | yes          | no            | no      |
| High color 565, red and blue swapped, compressed                           | 16                | yes          | no            | no      |
| High color A555 with alpha channel   | 15                | no           | yes           | no      |
| High color AM555 with alpha channel, red and blue swapped                  | 15                | no           | yes           | no      |
| High color A565 with alpha channel   | 16                | no           | yes           | no      |
| High color AM565 with alpha channel, red and blue swapped                  | 16                | no           | yes           | no      |
| True color 888   | 24                | no           | no            | no      |
| True color 8888 with alpha channel   | 32                | no           | yes           | no      |
| True color 8888 with alpha channel, compressed                             | 32                | yes          | yes           | no      |
| True color M8888I with alpha channel, red and blue swapped, alpha inverted | 32                | no           | yes           | no      |
| Alpha channel, compressed  | 8                 | yes          | yes           | no      |

### 8.3.6.2 Palette information

A bitmap palette is an array of 24 bit RGB color entries. Bitmaps with a color depth from 1 - 8 bpp can be saved with (device independent bitmap, DIB) or without palette information (device dependent bitmap DDB).

#### Device independent bitmaps (DIB)

The color information is stored in the form of an index into the color array. Before emWin draws a DIB, it converts the 24 bit RGB colors of the bitmap palette into color indices of the hardware palette. The advantage of using DIBs is that they are hardware independent and

can be drawn correctly on systems with different color configurations. The disadvantages are the additional ROM requirement for the palette and the slower performance because of the color conversion.

### Device dependent bitmaps (DDB)

The pixel information of a DDB is the index of the displays hardware palette. No conversion needs to be done before drawing a DDB. The advantages are less ROM requirement and a better performance. The disadvantage is that these bitmaps can not be displayed correctly on systems with other color configurations.

### 8.3.6.3 Transparency

A palette based bitmap can be converted to a transparent bitmap. Transparency means each pixel with index 0 will not produce any output. The command **Image → Transparency** can be used to select the color which should be used for transparency. After selecting the transparent color, the pixel indices of the image will be recalculated, so that the selected color is on position 0 of the bitmap palette. When saving the bitmap file as C file, it will be saved with the transparency attribute.

### 8.3.6.4 Alpha blending

Alpha blending is a method of combining an image with the background to create the effect of semi transparency. The alpha value of a pixel determines its transparency. The color of a pixel after drawing the bitmap is a blend of the former color and the color value in the bitmap. In emWin, logical colors are handled as 32 bit values. The lower 24 bits are used for the color information and the upper 8 bits are used to manage the alpha value. An alpha value of 0 means the image is opaque and a value of `0xFF` means completely transparent. Whereas BMP and GIF files do not support alpha blending PNG files support alpha blending. So the easiest way to create bitmap files with alpha blending is to load a PNG file. When working with BMP and/or GIF files the Bitmap Converter initially has no information about the alpha values.

#### Loading a PNG file

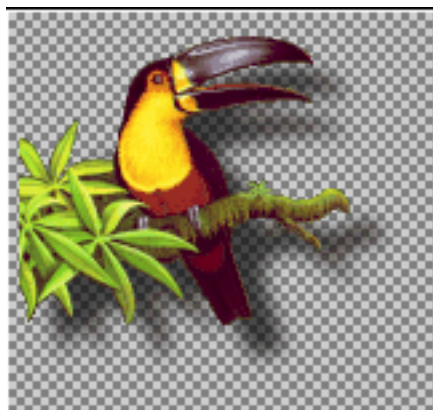

This is the most recommended way for creating bitmaps with an alpha mask:



The PNG file contains all required information.

#### Loading the alpha values from an alpha mask bitmap

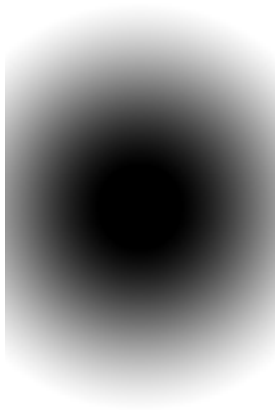



This method loads the alpha values from a separate file. Black pixels of the alpha mask file means opaque and white means transparent. The following table shows an example:

| Starting point  | Alpha mask  | Result  |
|---|---|---|
|  |  |  |

The command **File → Load Alpha Mask** can be used for loading an alpha mask.

### Creating the alpha values from two bitmaps

This method uses the difference between the pixels of two pictures to calculate the alpha values. The first image should show the item on a black background. The second image should show the same on a white background. The following table shows an example of how to create the alpha values using the command **File → Create Alpha**:

| Starting point   | Black background   | White background  | Result   |
|--|--|---|--|
|  |  |  |  |

The command **File → Create Alpha** can be used for creating the alpha values.

### 8.3.6.5 Selecting the best format

emWin supports various formats for the generated C file. It depends on several conditions which will be the 'best' format and there is no general rule to be used. Color depth, compression, palette and transparency affect the drawing performance and/or ROM requirement of the bitmap.

#### Color depth

In general the lower the color depth the smaller the ROM requirement of the bitmap. Each display driver has been optimized for drawing 1bpp bitmaps (text) and bitmaps with the same color depth as the display.

#### Compression

The supported RLE compression method has the best effect on bitmaps with many horizontal sequences of equal-colored pixels. Details later in this chapter. The performance is typically slightly slower than drawing uncompressed bitmaps.

### Palette

The ROM requirement of a palette is 4 bytes for each color. So a palette of 256 colors uses 1 KB. Furthermore emWin needs to convert the colors of the palette before drawing the bitmap. Advantage: Bitmaps are device independent meaning they can be displayed on any display, independent of its color depth and format.

### Transparency

The ROM requirement of transparent bitmaps is the same as without transparency. The performance is with transparency slightly slower than without.

### High color and true color bitmaps

Special consideration is required for bitmaps in these formats. Generally the use of these formats only make sense on displays with a color depth of 15 bits and above. Further it is strongly recommended to save the C files in the exact same format used by the hardware. Note that using the right format will have a positive effect on the drawing performance. If a high color bitmap for example should be shown on a system with a color depth of 16bpp which has the red and blue components swapped, the best format is 'High color 565, red and blue swapped'. Already a slightly other format has the effect, that each pixel needs color conversion, whereas a bitmap in the right format can be rendered very fast without color conversion. The difference of drawing performance in this case can be factor 10 and more.

## 8.3.6.6 Saving the file

The basic procedure for using the Bitmap Converter is illustrated below:

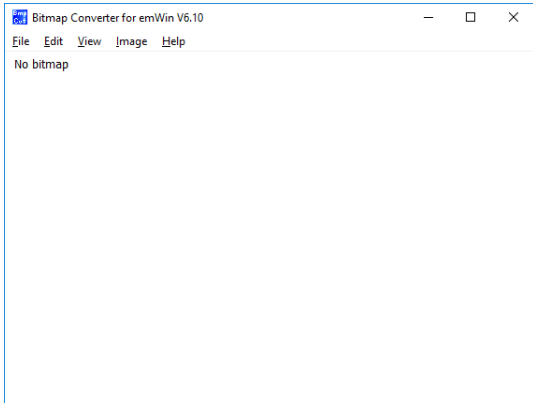
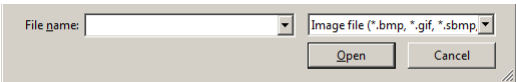
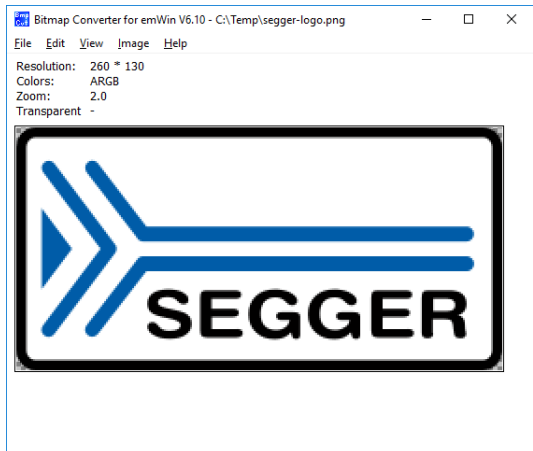
| Step  | Result   |
|---|--|
| <p><b>Step 1: Start the application.</b></p> <ul style="list-style-type: none"> <li>The Bitmap Converter is opened showing an empty window.</li> </ul>  |  |
| <p><b>Step 2: Load a bitmap into the Bitmap Converter.</b></p> <ul style="list-style-type: none"> <li>Choose <b>File → Open</b></li> <li>Locate the document you want to open and click <b>Open</b>. The Bitmap Converter can open images of the bmp, gif, png and sbmp format.</li> </ul>  <ul style="list-style-type: none"> <li>The Bitmap Converter displays the loaded bitmap.</li> </ul> |  |

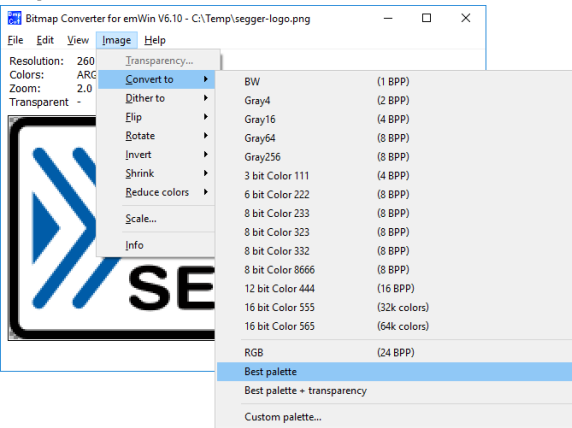
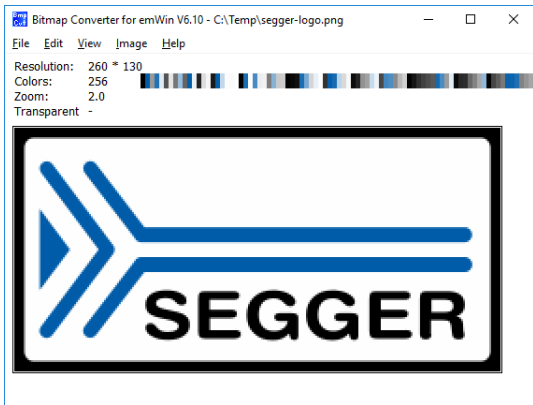
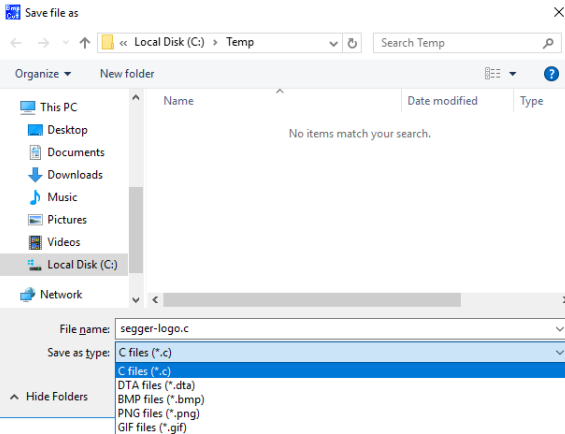
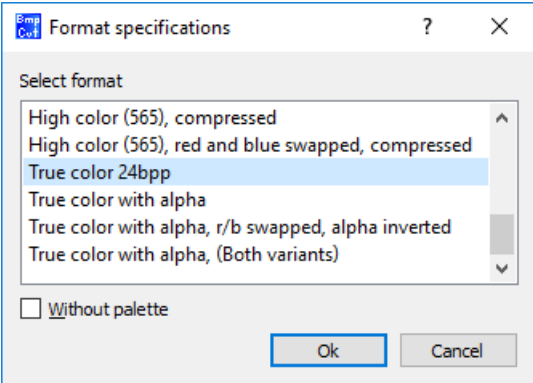
| Step  | Result   |
|---|--|
| <p><b>Step 3: Choose conversion</b></p>  <ul style="list-style-type: none"> <li>Choose <b>Image → Convert Into</b></li> <li>Select the desired palette. In this example, the option Best palette is chosen.</li> <li>The Bitmap Converter displays the converted bitmap.</li> </ul>  |  <ul style="list-style-type: none"> <li>The image is unchanged in terms of appearance, but uses less memory since a palette of only 15 colors is used instead of the full-color mode. These 15 colors are the only ones actually required to display this particular image.</li> </ul> |
| <p><b>Step 4: Save the bitmap as a C file.</b></p> <ul style="list-style-type: none"> <li>Choose <b>File → Save As.</b></li> <li>Select a destination and a name for the C file.</li> <li>Select the file type. In this example, the file is saved as C bitmap file.</li> <li>Click <b>Save.</b></li> </ul>   |   |
| <p><b>Step 5: Specify bitmap format.</b></p> <ul style="list-style-type: none"> <li>If the bitmap should be saved as C file the format should now be specified. Use one of the available formats shown in the dialog. If the bitmap should be saved without palette, activate the check box <b>Without palette.</b></li> <li>The Bitmap Converter will create a separate file in the specified destination, containing the C source code for the bitmap.</li> </ul> |    |

### 8.3.7 Generating C stream files

A C stream file consists of the same information as a C file. Contrary to a C file a data stream can be located anywhere and does not need to be compiled or linked with the project. All supported output formats described for C files are also available for C stream files. emWin supports creating bitmaps from data streams and drawing data streams directly. Detailed information about C stream file support can be found under *Drawing streamed bitmaps* on page 331.

```

(all values LSB):
Header (16 Bytes)
  2 Bytes Id (0x42, 0x4d, "BM")
  16 Bits Format (FORMAT_1BPP      - 1
                 FORMAT_2BPP      - 2
                 FORMAT_4BPP      - 4
                 FORMAT_8BPP      - 5
                 FORMAT_RLE1      - 32
                 FORMAT_RLE4      - 6
                 FORMAT_RLE8      - 7
                 FORMAT_565       - 8
                 FORMAT_M565      - 9
                 FORMAT_555       - 10
                 FORMAT_M555      - 11
                 FORMAT_RLE16     - 12
                 FORMAT_RLEM16    - 13
                 FORMAT_8888      - 16
                 FORMAT_RLE32     - 15
                 FORMAT_24        - 17
                 FORMAT_RLEALPHA  - 18
                 FORMAT_444_12    - 19
                 FORMAT_M444_12   - 20
                 FORMAT_444_12_1  - 21
                 FORMAT_M444_12_1 - 22
                 FORMAT_444_16    - 23
                 FORMAT_M444_16   - 24
                 FORMAT_A555      - 25
                 FORMAT_AM555     - 26
                 FORMAT_A565      - 27
                 FORMAT_AM565     - 28
                 FORMAT_M8888I    - 29)

  16 Bits xSize
  16 Bits ySize
  16 Bits BytesPerLine
  16 Bits BitsPerPixel
  16 Bits NumEntries (Number of colors in palette based bitmaps)
  16 Bits HasTrans (1 if transparency exists, 0 if not)
Palette data (4 bytes per entry)
  for each entry:
    if ("Save colors in ARGB" == 0):
      8 Bits Red
      8 Bits Green
      8 Bits Blue
      8 Bits Alpha
    if ("Save colors in ARGB" == 1):
      8 Bits Blue
      8 Bits Red
      8 Bits Green
      8 Bits Alpha
  // Pixel order is from left to right and from top to bottom
Pixel data (FORMAT_1BPP, FORMAT_2BPP, FORMAT_4BPP, FORMAT_8BPP):
  for each line:
    for each pixel:
      1-8 Bits per pixel index value
Pixel data (FORMAT_RLE1):
  MSB:   Color index
  7 Bits: Number of pixels
Pixel data (FORMAT_RLE4):
  8 Bit Counter
  if (Counter > 0):
    8 Bits index value into palette (Counter: number of pixels of same color)
    // Lower nibble used only
  if (Counter == 0):
    8 Bits number of pixels (1 or 2)
    8 Bits Index values into palette (Pixel 1: upper nibble, Pixel 2: lower
nibble)
    // If (HasTrans == 1) and (Index == 0) pixel is transparent

```

```

Pixel data (FORMAT_RLE8):
  8 Bit Counter
  if (Counter > 0):
    8 Bits index value into palette (Counter: number of pixels of same color)
  if (Counter == 0):
    8 Bits number of pixels (1 or 2)
    for each pixel:
      8 Bits Index value into palette
      // If (HasTrans == 1) and (Index == 0) pixel is transparent
Pixel data (FORMAT_RLEALPHA):
  8 Bit Counter
  if (Counter > 0):
    8 Bits Intensity (Counter: number of pixels of same intensity)
  if (Counter == 0):
    8 Bits number of pixels (1 or 2)
    for each pixel:
      8 Bits Intensity (Counter: number of pixels of same intensity)
Pixel data (FORMAT_RLE16, FORMAT_RLE16):
  8 Bit Counter
  if (Counter > 0):
    16 Bits color index value (Counter: number of pixels of same color)
  if (Counter == 0):
    8 Bits number of pixels (1 or 2)
    for each pixel:
      16 Bits color index value
Pixel data (FORMAT_RLE32):
  8 Bit Counter
  if (Counter > 0):
    32 Bits color value (Counter: number of pixels of same color)
  if (Counter == 0):
    8 Bits number of pixels (1 or 2)
    for each pixel:
      32 Bits color index value
Pixel data (FORMAT_565, FORMAT_M565, FORMAT_555, FORMAT_M555):
  for each line:
    for each pixel:
      16 Bits color index
Pixel data (FORMAT_8888, FORMAT_M8888I):
  for each line:
    for each pixel:
      32 Bits color value
Pixel data (FORMAT_24):
  for each line:
    for each pixel:
      8 Bits Red
      8 Bits Green
      8 Bits Blue
Pixel data (FORMAT_444_12, FORMAT_M444_12, FORMAT_444_12_1,
          FORMAT_M444_12_1, FORMAT_444_16, FORMAT_M444_16):
  for each line:
    for each pixel:
      16 Bits color index (12 Bits used only, dependent on format)
Pixel data (FORMAT_A555, FORMAT_AM555, FORMAT_A565, FORMAT_AM565):
  for each line:
    for each pixel:
      16 Bits color index (15 Bits color, 1 bit alpha, dependent on format)

```

### 8.3.8 Compressed bitmaps

The Bitmap Converter and emWin support run-length encoding (RLE) compression of bitmaps in the resulting source code files. The RLE compression method works most efficiently if your bitmap contains many horizontal sequences of equal-colored pixels. An efficiently compressed bitmap will save a significant amount of space. However, compression is not recommended for photographic or dithered images since they do not normally have sequences of identical pixels. It should also be noted that a compressed image may take slightly longer to display.



Storing a bitmap using RLE compression can be done by selecting one of the according output formats when saving as a C file: "C with palette, compressed" or "C without palette, compressed". There are no special functions needed for displaying compressed bitmaps; they are displayed the same way uncompressed bitmaps are displayed.

### Compression ratios

The ratio of compression achieved will vary depending on the bitmap used. The more horizontal uniformity in the image, the better the ratio will be. A higher number of bits per pixel will also result in a higher degree of compression.

In the bitmap used in the previous examples, the total number of pixels in the image is  $(200 * 94) = 18,800$ .

Since 2 pixels are stored in 1 byte, the total uncompressed size of the image is  $18,800 / 2 = 9,400$  bytes.

The total compressed size for this particular bitmap is 3,803 bytes for 18,800 pixels (see the example at the end of the chapter).

The ratio of compression can therefore be calculated as  $9,400 / 3,803 = 2.47$ .

## 8.3.9 Creating animated sprites / cursors

The Bitmap Converter can be used to convert animated GIF files to animated sprites / cursors in C file format. This functionality is offered by the entries in the file menu which are shown below:

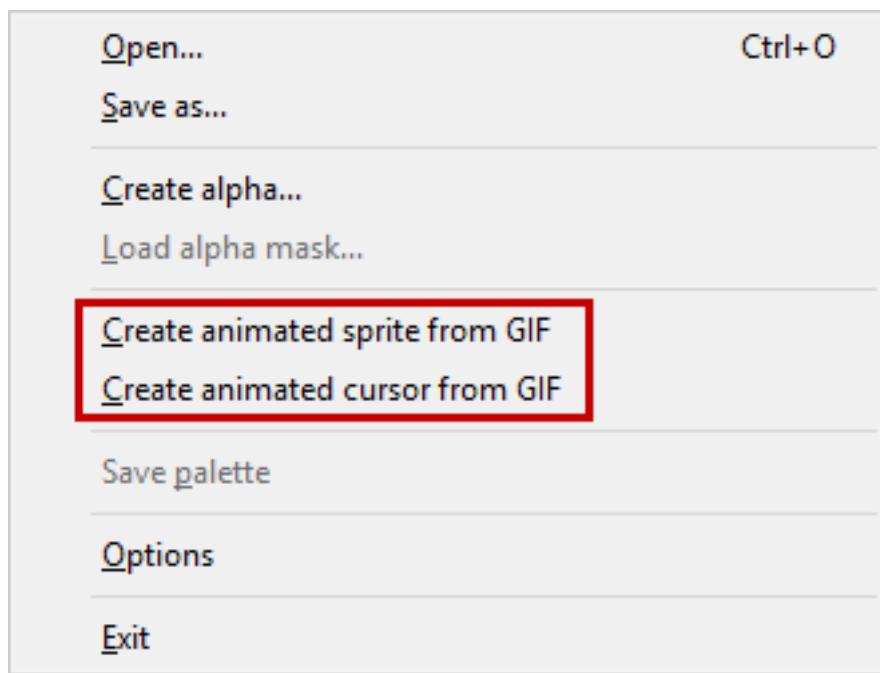

After clicking one of the according file menu entries, a file dialog appears and an animated GIF file can be chosen. Once this is done the name of the resulting C file needs to be specified. Converting animated GIF files to animated sprites / cursors does not require any further parameters. The process is performed automatically. Since the effort depends on the input GIF file, completing this task may take a moment. The Bitmap Converter can be used again as soon as the mouse cursor is changed to the simple arrow again.

### 8.3.9.1 Animated Sprite example

The following shows the structure of an animated sprite C file as it is generated by the Bitmap Converter. Although animations consist of several images, the palette and pixel data structures are shown only once here. Variable data is described using place holders.

## File header

```

/*****
 *          (c) 1998 - 2020 Segger Microcontroller GmbH          *
 *          Solutions for real time microcontroller applications  *
 *          www.segger.com                                       *
 *****/
 *
 * C-file generated by                                          *
 *
 *          Bitmap Converter for emWin V6.14.                   *
 *          Compiled Aug 27 2020, 16:57:05                     *
 *
 *          (c) 1998 - 2020 Segger Microcontroller GmbH          *
 *
 *****/
 *
 * Source file: %_FILENAME%.gif (Animated Sprite)              *
 * Dimensions:  %_X_SIZE% * %_Y_SIZE%                          *
 * NumImages:   %_NUMBER_OF_IMAGES%                            *
 * Duration:    %_OVERALL_DURATION%                            *
 * NumBytes:    %_NUMBER_OF_BYTES%                              *
 *
 *****/
 *
 * Usage:
 *   %_USAGE_EXAMPLE%
 */

#include <stdlib.h>
#include "GUI.h"
#ifdef GUI_CONST_STORAGE
    #define GUI_CONST_STORAGE const
#endif

```

## Palette and pixel data

```

static GUI_CONST_STORAGE GUI_COLOR%_FILENAME%%_INDEX%[] = {
    %_COLOR_DATA%
};

static GUI_CONST_STORAGE GUI_LOGPALETTE _Pal%_FILENAME%%_INDEX% = {
    %_NUMBER_OF_COLORS%, // Number of entries
    %_TRANSPARENCY_FLAG%, // No transparency
    &Colors%_FILENAME%%_INDEX%[0]
};

static GUI_CONST_STORAGE unsigned char _ac%_FILENAME%%_INDEX%[] = {
    %_PIXEL_DATA%
};

```

## General data

```

static GUI_CONST_STORAGE GUI_BITMAP _abm%_FILENAME%[] = {
    { %_X_SIZE%, %_Y_SIZE%,
      %_BYTES_PER_LINE%, %_BITS_PER_PIXEL%,
      _ac%_FILENAME%%_INDEX%, &Pal%_FILENAME%%_INDEX%
    },
    [...]
};

const GUI_BITMAP * apbm%_FILENAME%[] = {
    &_abm%_FILENAME%[0],
    [...]
};

```

```
const unsigned aDelay%_FILENAME_%[] = {
    %_DELAY_DATA_%
};

/***** End of file *****/
```

### 8.3.9.2 Animated Cursor example

The file structure for animated cursors almost equals the structure for animated sprites. Therefore only the differences are mentioned here. The array of bitmap pointers is defined as static:

```
static const GUI_BITMAP * _apbm%_FILENAME_%[] = {
    [...]
};
```

The array of delays is defined as static:

```
static const unsigned _aDelay%_FILENAME_%[] = {
    [...]
};
```

A non-static definition of a GUI\_CURSOR\_ANIM structure is placed at the end:

```
const GUI_CURSOR_ANIM Cursor%_FILENAME_% = {
    _apbm%_FILENAME_%, // Pointer to an array of bitmaps
    0, // x coordinate of the hot spot
    0, // y coordinate of the hot spot
    0, // Period, should be 0 here
    _aDelay%_FILENAME_%, // Pointer to an array of periods
    %_NUMBER_OF_IMAGES_% // Number of images
};
```

### 8.3.9.3 Additional information

The hot spot coordinate define the position which is recognized by emWin when PID events occur. If the hot spot should not be represented by the topmost leftmost pixel, the according values in the GUI\_CURSOR\_ANIM structure may be modified.

The array of delays is always created. In case every image uses the same delay, the forth value in the GUI\_CURSOR\_ANIM structure may be set accordingly. In this case the array of delays may be deleted after the fifth value of the GUI\_CURSOR\_ANIM structure was set to NULL.

### 8.3.10 Converting GIFs into Bitmap-EMFs

#### About Bitmap-EMFs

General information about the Bitmap-EMF format can be read in the "Movies" chapter under *Bitmap-EMF files* on page 647.

#### Generating a Bitmap-EMF using the Bitmap Converter

GIF animations can be converted into bitmap-based EMFs using the Bitmap Converter. Below is a step-by-step guide on how to generate EMF files from GIF animations.

1. Open Bitmap Converter.
2. Click **File → Create emWin movie file from GIF.**

Create emWin movie file from GIF

3. Select GIF file for conversion.

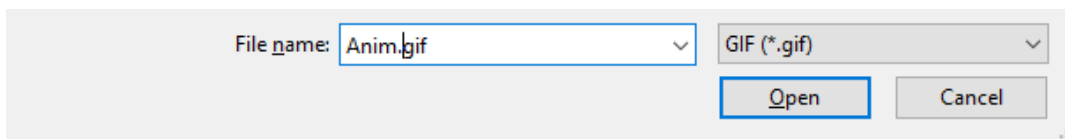

4. Select bitmap format to be used for each frame.

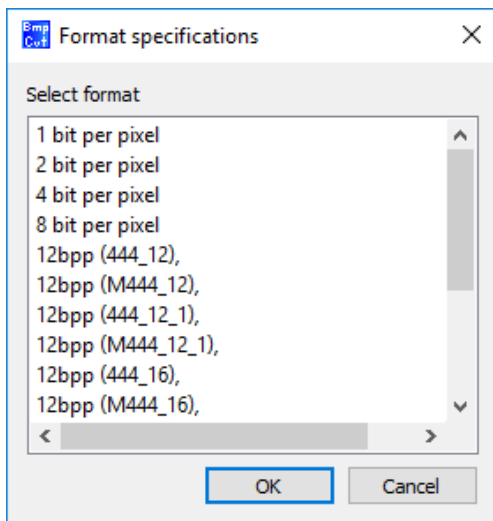

5. Select color format to be used for each frame. The frames can be either dithered or converted into the desired color format.

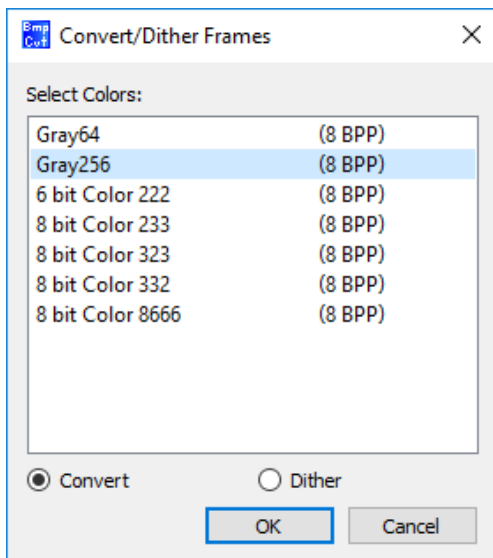

## 6. Save EMF file.

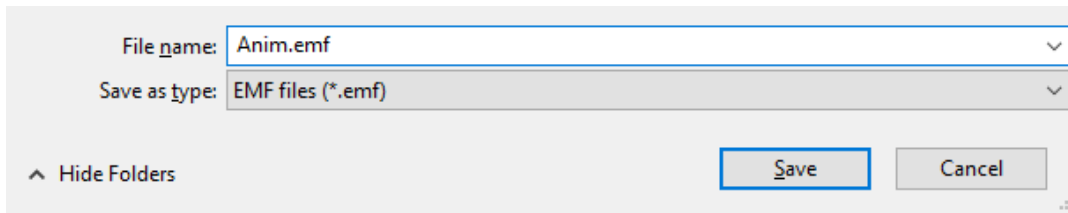

### Color format dialog

This dialog will be prompted when the desired format is 16bpp or lower. The listed color formats are dependent on the previously selected bitmap format. For example, when selecting the 8bpp format, all available color formats for 8bpp are available for conversion, as shown above in step 5.

### Playing a movie

The “Movies” chapter provides detailed information about how bitmap-EMFs can be displayed using emWin. An example can be found under *Bitmap-EMF files* on page 647.

### 8.3.11 Memory footprint

The memory footprint of any exported files is shown in the lower left corner of the Bitmap Converter. The byte count of an exported C bitmap, cursor or sprite is a sum of the number of bytes needed for all structures, palettes and pixel data.

Memory footprint of last saved file: 144,885 bytes

For C bitmaps, sprites and animated cursors, the amount of bytes is also written into the header.

### 8.3.12 Command line usage

It is also possible to work with the Bitmap Converter using the command prompt. All conversion functions available in the Bitmap Converter menu are available as commands, and any number of functions may be performed on a bitmap in one command line.

#### 8.3.12.1 Format for commands

Commands are entered using the following format:

```
BmpCvt <filename>.bmp <-command>
```

If more than one command is used, one space is typed between each. For example, a bitmap with the name logo.bmp is converted into Best palette format and saved as a C file named logo.bmp all at once by entering the following at the command prompt:

```
BmpCvt logo.bmp -convertintobestpalette -saveaslogo,1 -exit
```

Note that while the file to be loaded into the Bitmap Converter always includes its bmp extension, no file extension is written in the `-saveas` command. An integer is used instead to specify the desired file type. The number 1 in the `-saveas` command above designates "C with palette". The `-exit` command automatically closes the program upon completion. See the table below for more information.

#### 8.3.12.2 Command line options

The following table lists all permitted Bitmap Converter commands. It can also be viewed at any time by entering `BmpCvt -?` at the command prompt.

| Command                               | Description                                |
|---------------------------------------|--|
| <code>-convertintobw</code>           | Convert to BW.                             |
| <code>-convertintogray4</code>        | Convert to Gray4.                          |
| <code>-convertintogray16</code>       | Convert to Gray16.                         |
| <code>-convertintogray64</code>       | Convert to Gray64.                         |
| <code>-convertintogray256</code>      | Convert to Gray256.                        |
| <code>-convertinto111</code>          | Convert to 111.                            |
| <code>-convertinto222</code>          | Convert to 222.                            |
| <code>-convertinto233</code>          | Convert to 233.                            |
| <code>-convertinto323</code>          | Convert to 323.                            |
| <code>-convertinto332</code>          | Convert to 332.                            |
| <code>-convertinto8666</code>         | Convert to 8666.                           |
| <code>-convertintorgb</code>          | Convert to RGB.                            |
| <code>-convertintobestpalette</code>  | Convert to best palette.                   |
| <code>-convertintotranspalette</code> | Convert to best palette with transparency. |

| Command  | Description   |
|--|---|
| <code>-convertintocustompalette&lt;filename&gt;</code>                                 | Convert to a custom palette.  |
| <code>&lt;filename&gt;</code>  | User-specified filename of desired custom palette.  |
| <code>-exit</code>   | Terminate PC program automatically.   |
| <code>-fliph</code>  | Flip image horizontally.  |
| <code>-flipv</code>  | Flip image vertically.  |
| <code>-help</code>   | Displays the command line table.  |
| <code>-hide</code>   | Hides the application window.   |
| <code>-invertindices</code>  | Invert indices.   |
| <code>-invertpalette</code>  | Invert palette entries.   |
| <code>-reducecolors&lt;numcolors&gt;</code>  | Reduce number of used colors.   |
| <code>&lt;numcolors&gt;</code>   | Number of colors to be used.  |
| <code>-rotate90cw</code>   | Rotate image by 90 degrees clockwise.   |
| <code>-rotate90ccw</code>  | Rotate image by 90 degrees counterclockwise.  |
| <code>-rotate180</code>  | Rotate image by 180 degrees.  |
| <code>-saveas&lt;filename&gt;, &lt;type&gt;[ , &lt;fmt&gt; [ , &lt;noplt&gt; ]]</code> | Save file as filename.  |
| <code>&lt;filename&gt;</code>  | User-specified file name including the file extension.  |
| <code>&lt;type&gt;</code>  | Must be an integer from 1 to 4 as follows:<br>1: C with palette (.c file)<br>2: Windows Bitmap file (bmp file)<br>3: C stream (.dta file)<br>4: GIF format (gif file)   |
| <code>&lt;fmt&gt;</code>   | Specifies the bitmap format (only if type = 1):<br>1: 1 bit per pixel*<br>2: 2 bits per pixel*<br>4: 4 bits per pixel*<br>5: 8 bits per pixel*<br>32: RLE1 compression*<br>6: RLE4 compression*<br>7: RLE8 compression*<br>8: High color 565<br>9: High color 565, red and blue swapped<br>10: High color 555<br>11: High color 555, red and blue swapped<br>12: RLE16 compression<br>13: RLE16 compression, red and blue swapped<br>15: True color 32bpp, compressed<br>16: True color 32bpp<br>17: True color 24bpp<br>18: Alpha channel 8bpp, compressed<br>19: 16bpp (444_12)<br>20: 16bpp (444_12), RB swapped<br>21: 16bpp (444_12_1)<br>22: 16bpp (444_12_1), RB swapped<br>23: 16bpp (444_16)<br>24: 16bpp (444_16), RB swapped<br>25: High color (A555) with alpha channel<br>26: High color (AM555) with alpha channel, red and blue swapped<br>27: High color (A565) with alpha channel<br>28: High color (AM565) with alpha channel, red and blue swapped |

| Command                  | Description   |
|--------------------------|---|
|                          | 29: True color 32bpp, red and blue swapped, alpha inverted<br>If this parameter is not given, the Bitmap Converter uses the following default formats in dependence of the number of colors of the bitmap:<br>Number of colors ≤ 2: 1 bit per pixel<br>Number of colors ≤ 4: 2 bits per pixel<br>Number of colors ≤ 16: 4 bits per pixel<br>Number of colors ≤ 256: 8 bits per pixel<br>RGB: High color 565 |
| <nopl>                   | Saves the bitmap with or without palette (only if type = 1)<br>0: Save bitmap with palette (default)<br>1: Save bitmap without palette  |
| -scale<WIDTH>, <HEIGHT>  | Scale image   |
| <WIDTH>                  | Width in percent.   |
| <HEIGHT>                 | Height in percent.  |
| -transparency<RGB-Color> | Sets the transparent color.   |
| <RGB-Color>              | RGB color which should be used as transparent color.  |
| -?                       | Displays the command line table.  |

**Note**

\* Images need to be converted to an according format before they can be stored in a format of 8 or less bpp.

### 8.3.13 Options

The Bitmap Converter offers you three more options when converting and saving a bitmap file. When clicking on the 'Options' entry in the menu bar an options dialog will pop up. The following table will explain the available options:

| Option                | Description  |
|-----------------------|--|
| Preserve transparency | If checked this option allows to convert an image, containing transparent pixels, in a palette based format and preserve the transparency. If not checked the transparency gets lost.                                |
| Big endian mode       | This option is only useful if an image gets stored as a DTA file. With the C files the compiler takes care of the endianness but for binary files it is necessary to have them available with the proper byte order. |
| Save colors in ARGB   | This option makes sure to save the colors of a palette as 32bit value where the alpha channel is inverted and the red and blue channels are swapped.   |

### 8.3.14 Example of a converted bitmap

A typical example for the use of the Bitmap Converter would be the conversion of your company logo into a C bitmap. Take another look at the example bitmap pictured below:





The bitmap is loaded into the Bitmap Converter, converted to Best palette, and saved as "C with palette". The resulting C source code is displayed below (some data is not shown to conserve space).

### Resulting C code (generated by the Bitmap Converter)

```

/*****
 *          (c) 1998 - 2020 Segger Microcontroller GmbH          *
 *          Solutions for real time microcontroller applications *
 *          www.segger.com                                     *
 *****/
 *
 * C-file generated by                                         *
 *
 *          Bitmap Converter for emWin V6.14.                  *
 *          Compiled Aug 27 2020, 16:57:05                    *
 *
 *          (c) 1998 - 2020 Segger Microcontroller GmbH          *
 *
 *****/
 *
 * Source file: SeggerLogo200                                  *
 * Dimensions:  200 * 100                                       *
 * NumColors:   256                                             *
 * NumBytes:    20164                                           *
 *
 *****/
*/

#include <stdlib.h>
#include "GUI.h"
#ifndef GUI_CONST_STORAGE
#define GUI_CONST_STORAGE const
#endif

extern GUI_CONST_STORAGE GUI_BITMAP bmSeggerLogo200;

static GUI_CONST_STORAGE GUI_COLOR _ColorsSeggerLogo200[] = {
#if (GUI_USE_ARGB == 0)
    0x00FFFFFF, 0x00353537, 0x009C4B37, 0x00CDCDCD,
    [...]
#else
    0x00FFFFFF, 0x00373535, 0x00374B9C, 0x00CDCDCD,
    [...]
#endif
};

static GUI_CONST_STORAGE GUI_LOGPALETTE _PalSeggerLogo200 = {
    33, // Number of entries
    0, // No transparency
    (const LCD_COLOR *)&_ColorsSeggerLogo200[0]
};

static GUI_CONST_STORAGE unsigned char _acSeggerLogo200[] = {
    0x00, 0x00, // Not all data is shown in this example.
    0x00, 0x92,
    [...]
}

```

```

    0xC6, 0x22,
    0x0A, 0x22
};

GUI_CONST_STORAGE GUI_BITMAP bmSeggerLogo200 = {
    200, // xSize
    100, // ySize
    200, // BytesPerLine
    8,   // BitsPerPixel
    _acSeggerLogo200, // Pointer to picture data (indices)
    &_PalSeggerLogo200 // Pointer to palette
};

/***** End of file *****/

```

## Compressing the file

We can use the same bitmap image to create a compressed C file, which is done simply by loading and converting the bitmap as before, and saving it as “C with palette, compressed”. The source code is displayed below (some data is not shown to conserve space). The compressed image size can be seen towards the end of the file as 3,730 bytes for 18,800 pixels.

## Resulting compressed C code (generated by the Bitmap Converter)

```

/*****
 *          (c) 1998 - 2020 Segger Microcontroller GmbH          *
 *      Solutions for real time microcontroller applications    *
 *                               www.segger.com                  *
 *****/
 *
 * C-file generated by                                          *
 *
 *      Bitmap Converter for emWin V6.14.                      *
 *      Compiled Aug 27 2020, 16:57:05                        *
 *
 *      (c) 1998 - 2020 Segger Microcontroller GmbH          *
 *
 *****/
 *
 * Source file: SeggerLogo200                                  *
 * Dimensions: 200 * 100                                       *
 * NumColors: 256                                              *
 * NumBytes: 3894                                              *
 *
 *****/
 */

#include <stdlib.h>
#include "GUI.h"
#ifndef GUI_CONST_STORAGE
    #define GUI_CONST_STORAGE const
#endif

extern GUI_CONST_STORAGE GUI_BITMAP bmSeggerLogo200_comp;

static GUI_CONST_STORAGE GUI_COLOR _ColorsSeggerLogo200_comp[] = {
#if (GUI_USE_ARGB == 0)
    0x00FFFFFF, 0x00353537, 0x009C4B37, 0x00CDCDCD,
    [...]
#else
    0x00FFFFFF, 0x00373535, 0x00374B9C, 0x00CDCDCD,
    [...]
#endif
};

```

```
static GUI_CONST_STORAGE GUI_LOGPALETTE _PalSeggerLogo200_comp = {
    33, // Number of entries
    0, // No transparency
    (const LCD_COLOR *)&_ColorsSeggerLogo200_comp[0]
};

static GUI_CONST_STORAGE unsigned char _acSeggerLogo200_comp[] = {
    /* RLE: 006 Pixels @ 000,000 */ 6, 0x00,
    /* RLE: 188 Pixels @ 006,000 */ 188, 0x01,
    [...],
    /* RLE: 188 Pixels @ 006,099 */ 188, 0x01,
    /* RLE: 006 Pixels @ 194,099 */ 6, 0x00,
    0
}; // 3730 bytes for 20000 pixels

GUI_CONST_STORAGE GUI_BITMAP bmSeggerLogo200_comp = {
    200, // xSize
    100, // ySize
    200, // BytesPerLine
    GUI_COMPRESS_RLE8, // BitsPerPixel
    _acSeggerLogo200_comp, // Pointer to picture data (indices)
    &_PalSeggerLogo200_comp, // Pointer to palette
    GUI_DRAW_RLE8
};

/***** End of file *****/
```

## 8.4 Font Converter

The Font Converter is a Windows program which allows convenient converting of any PC installed font into an emWin (bitmap) font which can be easily integrated into emWin based applications. PC installed fonts may be protected by copyright or any other intellectual property right of their legal owner. emWin fonts should be defined either as `GUI_FONT` structures in C files or should exist as binary files containing System Independent Fonts (SIF) or External Bitmap Font (XBF). Manual creation of those fonts is possible, but since this would be very time-consuming and inefficient, it is recommended to use the Font Converter instead.

The Font Converter is not part of the emWin Basic package. The full version has to be purchased separately. The emWin Basic package comes with the demo version of the Font Converter which provides full functionality but accurate storage of pixel data. Nevertheless the structure of C file fonts is stored well, so one might have a look at it in order to estimate the possibly saved effort by using the Font Converter.

The Font Converter does not come with any fonts or a permission or license to use any PC installed font for converting purposes. It is users sole responsibility to not infringe upon any third party intellectual property right by making use of the fonts in its application and obtain a license if required by the legal owner of the font.

### 8.4.1 Requirements

The Font Converter is a Windows program, so it can be used only within a windows environment. The source fonts need to meet the following requirements:

- The font is installed in Windows.
- The font is usable in Windows. (e.g. in MS Word)
- The 'Character To Glyph Index Mapping Table' (cmap) of a font file needs at least a legal subtable with a platform ID = 3 (Windows) and an encoding ID = 1 (Unicode).

### Screenshot of the Font Converter with a loaded font

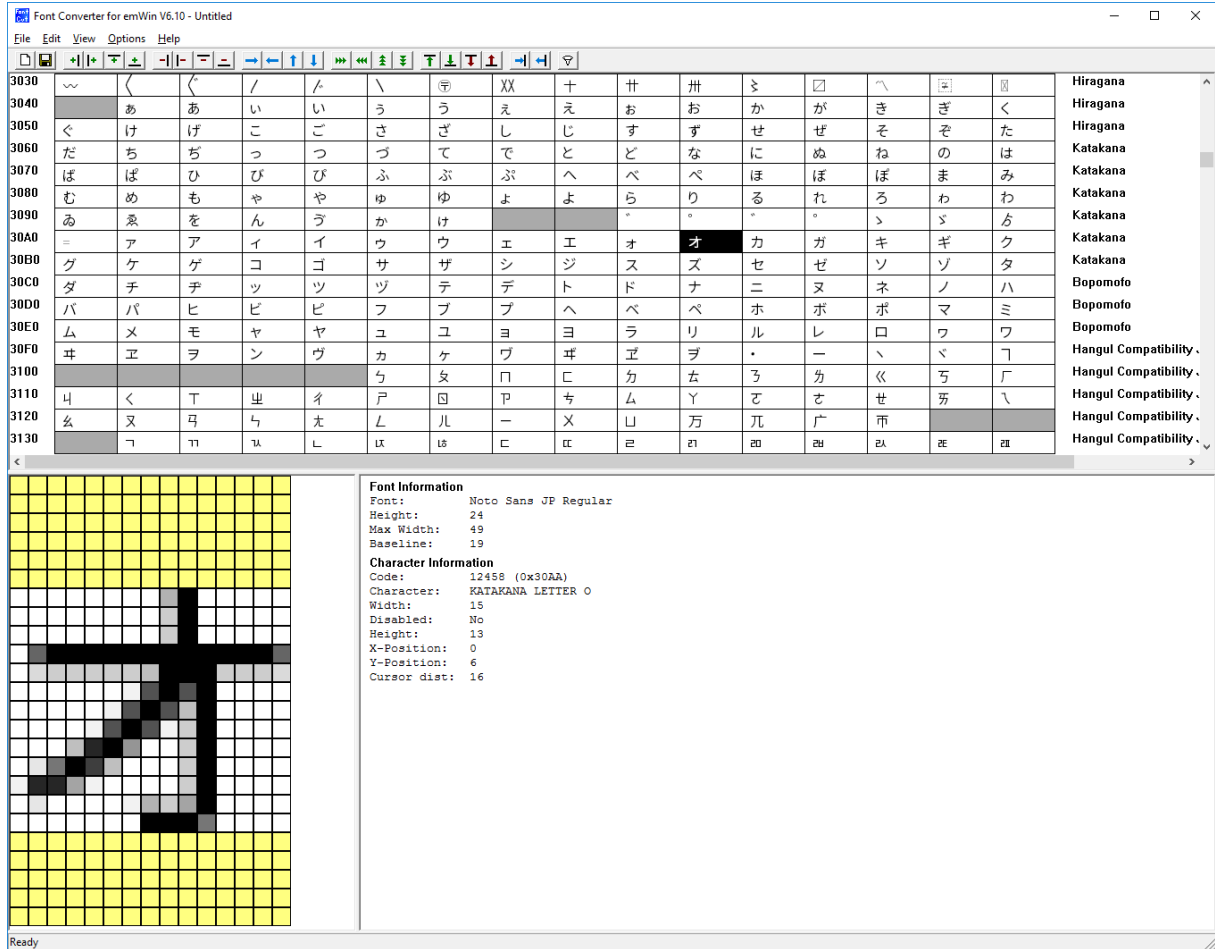

## 8.4.2 Creating an emWin font file from a Windows font

The basic procedure for using the Font Converter for creating an emWin font file from an installed Windows font is illustrated below. The steps are explained in detail in the following sections.

### Step 1: Application start

As the Font Converter is started it immediately shows the "Font generation options" dialog box. The same dialog box appears if **File → New** (CTRL+N) is chosen from the Font Converter menu bar.

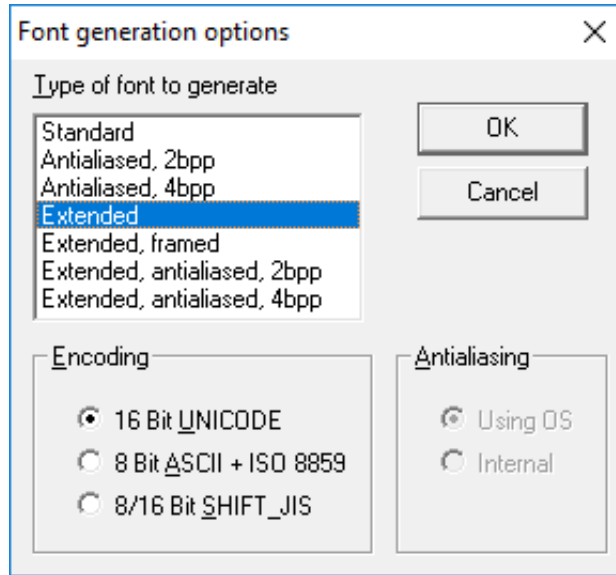

### Step 2: Specifying the type of font

In the above screenshot, a font is to be generated in extended mode using Unicode 16 Bit encoding. The anti-aliasing option can be modified only in case a font type is selected which supports anti-aliasing.

### Step 3: Specifying the actual font

After confirming the "Font generation options", the "Font" dialog is opened which allows choosing a font, its style and size.

Please note that fonts with a size larger than 255 pixels in any direction can not be created and displayed.

The fonts shown in the selection list depend on MS Windows. In case an installed font is not shown, it might be required to change Windows font settings. Detailed information can be found in the section *Troubleshooting* on page 2854.

In this example, a regular-style, 16 pixel Arial font is chosen.

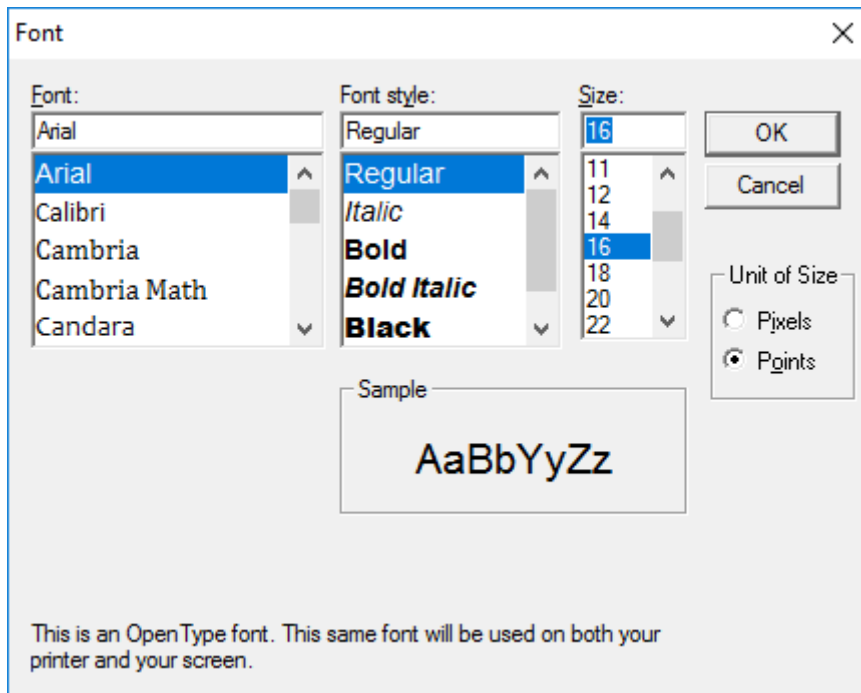

### Step 4: Modifying the font

Detail information on the possibilities to modify the currently loaded font can be found in the section *User Interface* on page 2839. Please note that the letter 'a' has to be present in a font to calculate the baseline.

### Step 5: Saving the font file

Choosing **File** → **Save As...** from the menu bar opens the "Save font as" dialog which is shown below. In this dialog the desired format of the font file can be selected:

- C file (\*.c)
- System independent font (\*.sif)
- External binary font (\*.xbf)

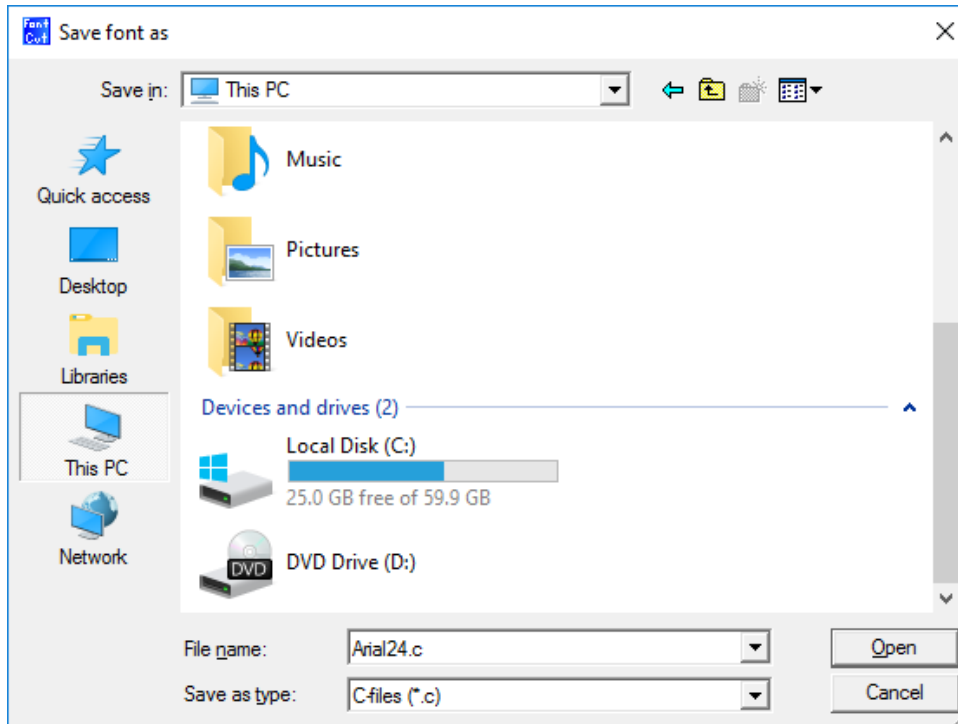

Clicking the **Save** button creates a font file of the selected format at the current location using the specified file name. Detailed information about the font types and how to use them can be found in the chapter *Fonts* on page 525.

### 8.4.3 Font generation options dialog

After starting the program or when choosing the menu point **File** → **New**, the following dialog automatically occurs:

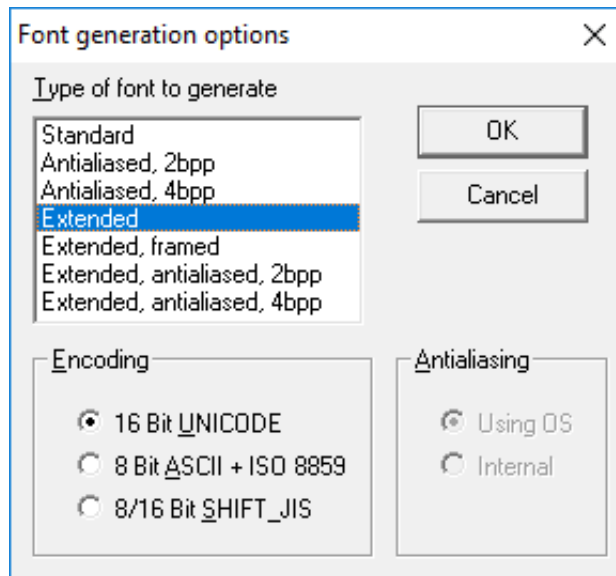

The selections made here will determine the output mode of the generated font, how it is to be encoded, and how it will be anti-aliased in case an anti-aliased output mode is selected.

### 8.4.3.1 Type of font to generate

| Type                       | Description   |
|----------------------------|---|
| Standard                   | Creates a 1 bit per pixel font without anti-aliasing.   |
| Anti-aliased 2bpp          | Creates an anti-aliased font using 2 bits per pixel.  |
| Anti-aliased 4bpp          | Creates an anti-aliased font using 4 bits per pixel.  |
| Extended                   | Creates a non anti-aliased 1 bit per pixel font with extended character information. This type supports compound characters like they are used in the Thai language.  |
| Extended framed            | Creates a non anti-aliased 1 bit per pixel font with extended character information with a surrounding frame. A framed font is always drawn in transparent mode regardless of the current settings. The character pixels are drawn in the currently selected foreground color and the frame is drawn in background color. |
| Extended anti-aliased 2bpp | Creates an anti-aliased 2 bit per pixel font with extended character information. Each character has the same height and its own width. The pixel information is saved with 2bpp anti-aliasing information and covers only the areas of the glyph bitmaps.  |
| Extended anti-aliased 4bpp | Creates an anti-aliased 4 bit per pixel font with extended character information. Each character has the same height and its own width. The pixel information is saved with 4bpp anti-aliasing information and covers only the areas of the glyph bitmaps.  |

### 8.4.3.2 Encoding

| Encoding               | Description   |
|------------------------|---|
| Unicode 16 Bit         | With Unicode encoding, you have access to all characters of a font. Windows font files contain a maximum of 65536 characters. All character codes of the C file are the same as those in the Windows font file. |
| ASCII 8 Bit + ISO 8859 | This encoding mode includes the ASCII codes (0x20 - 0x7F) and the ISO 8859 characters (0xA0 - 0xFF).  |
| SHIFT JIS 8/16 Bit     | Shift JIS (Japanese Industry Standard) enables mapping from Unicode to Shift JIS in accordance with the Unicode standard 2. For example, the Katakana letter  |



| Encoding | Description   |
|----------|---|
|          | "KU" is shifted from its Unicode value of 0x30AF to the Shift JIS value of 0x834E, the Kanji character 0x786F is shifted to 0x8CA5 and so on. |

### 8.4.3.3 Antialiasing

You can choose between two ways of anti-aliasing. This choice only applies when an anti-aliased font type has been selected.

| Antialiasing | Description   |
|--------------|---|
| Using OS     | The operating system is used to do the anti-aliasing. The resulting characters appear exactly the same as in any other windows application where anti-aliased characters are displayed. |
| Internal     | The internal anti-aliasing routines of the Font Converter are used to do the anti-aliasing. The resulting characters are more exact with regard to proportions.                         |

### Showcase

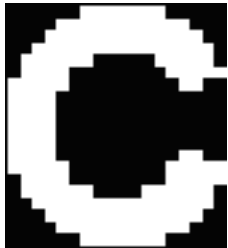
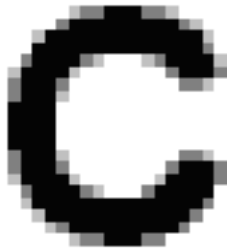
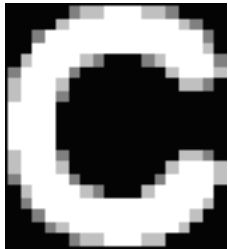
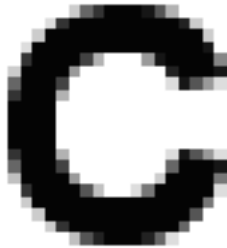
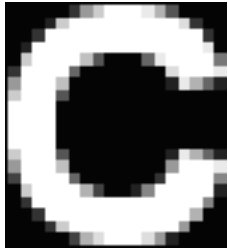
| Font Type  | Black On White  | White On Black  |
|--|---|---|
| Standard<br>(no anti-aliasing)<br>1 bpp<br>2 shades  |   |   |
| Low-quality<br>(anti-aliased)<br>2 bpp<br>4 shades   |  |  |
| High-quality<br>(anti-aliased)<br>4 bpp<br>16 shades |  |  |

### 8.4.4 Font Dialog

The Font Dialog appears after the font generation options have been confirmed:

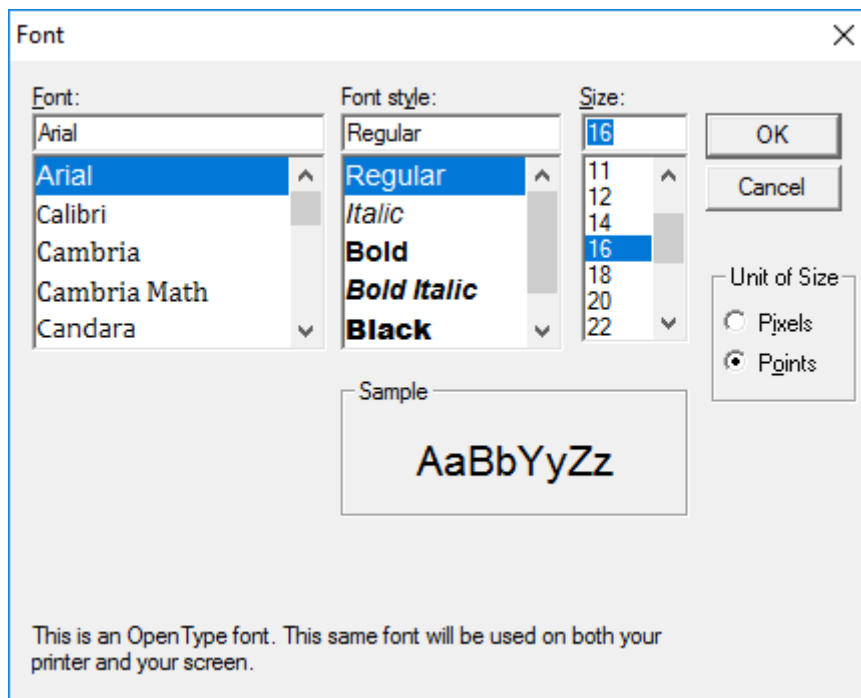

This dialog allows selecting a font which has to be used in the target application. Confirming this dialog using the 'OK' button makes the Font Converter load the included characters and display it in the main user interface.

#### Note

Fonts which are legally owned by third parties may require a valid license in order to use them in a target system. emWin does not come with licenses for third party fonts.

All fonts included in emWin can be used according to the license under which emWin was provided. Detailed listings of those fonts and the included character sets can be found under *Standard fonts* on page 593.

#### 8.4.4.1 Font, Font Style, and Size

These menus are used to select the particular font to be converted. The size of the font is specified in pixels.

#### 8.4.4.2 Script

The Script box is used to select the character set which should be mapped down from Unicode into the first 256 characters in accordance with ISO 8859. It only applies when using the 8 Bit ASCII + ISO 8859 encoding mode.

#### 8.4.4.3 Unit of Size

This option button can be used to set 'Points' or 'Pixels' as measuring unit. Please note that emWin does not know something about the unit 'Points' whereas most of other PC applications use the point size for specifying the font size. The Font Converter uses the operating system for getting the desired font resource. Please note that the font mapper of the operating system is not able to create each font in each desired pixel height. In these cases the font mapper of the operating system creates the nearest possible pixel height. This is not a bug of the Font Converter.

### 8.4.5 User Interface

After clicking OK in the Font dialog box, the main user interface of the Font Converter appears, loaded with the previously selected font. You may convert the font into a C file immediately if you wish or edit its appearance first.

The Font Converter is divided into two areas. In the upper area, all font characters appear scaled 1:1 as they will be displayed on your target device. Disabled characters are shown with a gray background. Per default all character codes which are not included in the chosen font are disabled. For example, many fonts do not include character codes from 0x00 to 0x1F and 0x7F to 0x9F, so these codes are grayed. The current character is displayed in a magnified scale on the left side of the lower area. Additional information about the font and the current character can be seen on the right side. If you want to modify the character data, you must first activate the lower area, either by pressing the <TAB> key or by simply clicking in the area.

#### 8.4.5.1 Selecting the current character

Characters may be selected:

- by using the keys <UP>, <DOWN>, <LEFT>, <RIGHT>, <PGUP>, <PGDOWN>, <POS1> or <END>
- by using the scroll bars
- by clicking a character with the left mouse button

#### 8.4.5.2 Toggling character status

Use the right mouse button to toggle the status of a specific character or to enable/disable an entire row of characters. The menu point **Edit → Toggle activation** as well as the <SPACE> key will toggle the status of the current character.

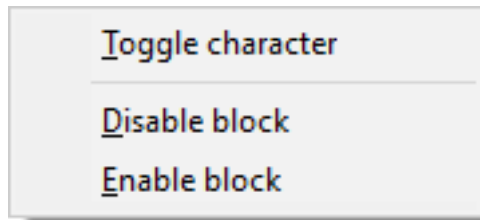

If you need to change the status of a particular range of characters, choose **Edit → Enable range of characters** or **Edit → Disable range of characters** from the menu. The range to be enabled or disabled is then specified in a dialog box using hexadecimal character values. To disable all characters, select **Edit → Disable all characters** from the menu.

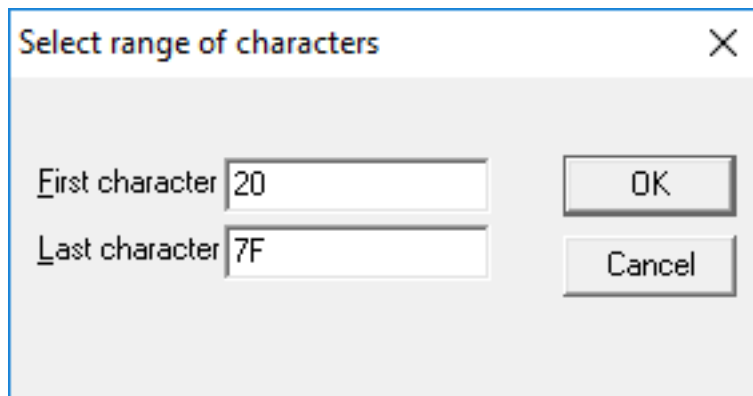

#### 8.4.5.3 Selecting pixels

When the lower area of the user interface is activated, you can move through the pixels with the cursor, either by using the <UP>, <DOWN>, <LEFT> and <RIGHT> keys or by clicking on the pixels with the left mouse button.

### 8.4.5.4 Modifying character bits

In the lower area you can use the <SPACE> key to invert the currently selected bit. In anti-aliased mode, you can increase and decrease the intensity of a pixel with the keys <+> and <->.

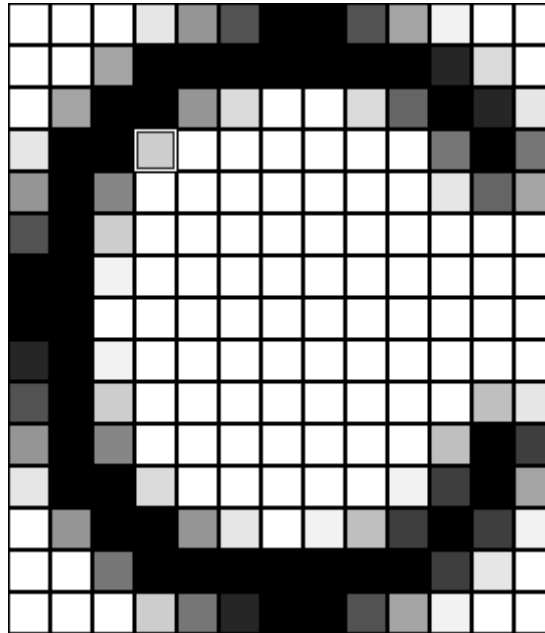

The status bar displays the intensity of the current pixel as follows:

Index of pixel [ 3, 3 ] = 4

### 8.4.5.5 Operations

The following size / shift / move operations are available:





#### Size operations

The size of a character (the font) may be modified by selecting **Edit → Insert → Right, Left, Top, Bottom** or **Edit → Delete → Right, Left, Top, Bottom** from the menu, or by using the toolbar:

| Button | Operation                        |
|--------|----------------------------------|
|        | Add one pixel to the right.      |
|        | Add one pixel to the left.       |
|        | Add one pixel at the top.        |
|        | Add one pixel at the bottom.     |
|        | Delete one pixel from the right. |
|        | Delete one pixel to the left.    |
|        | Delete one pixel at the top.     |
|        | Delete one pixel at the bottom.  |





## Shift operations

Choose **Edit → Shift → Right, Left, Up, Down** from the menu to shift the bits of the current character in the respective direction, or use the toolbar:

| Button  | Operation               |
|---|-------------------------|
|  | Shift all pixels right. |
|  | Shift all pixels left.  |
|  | Shift all pixels up.    |
|  | Shift all pixels down.  |



## Move operations (extended font format only)

Choose **Edit → Move → Right, Left, Up, Down** from the menu to move the character position in the respective direction, or use the toolbar:

| Button  | Operation                |
|---|--------------------------|
|    | Move image to the right. |
|   | Move image to the left.  |
|  | Move image up.           |
|  | Move image down.         |





## Change cursor distance (extended font format only)

Choose **Edit/Cursor distance/Increase, Decrease** from the menu to move the character position in the respective direction, or use the toolbar:

| Button  | Operation                 |
|---|---------------------------|
|  | Increase cursor distance. |
|  | Decrease cursor distance. |

## Change font height (extended font format only)

Choose **Edit → Font height → [Insert, Delete] [top, bottom]** from the menu to add or remove a row to or from the font, or use the toolbar:

| Button  | Operation                                 |
|---|---|
|  | Insert a row at the top of the font.      |
|  | Insert a row at the bottom of the font.   |
|  | Delete a row from the top of the font.    |
|  | Delete a row from the bottom of the font. |

### 8.4.5.5.1 Modifying the viewing mode

The view mode may be changed by selecting the following options from the menu:

#### View/All Characters

If enabled (standard), all characters are shown. If disabled, only the rows with at least one enabled character are shown.

| Button  | Operation             |
|---|-----------------------|
|  | Toggles viewing mode. |

## 8.4.6 Options

### Compatibility options

The Font Converter is able to create font files for all versions of emWin. Because there have been a few small changes of the font format from the emWin version 3.50 to the version 3.52, the C font files for these versions should be slightly different to avoid compiler warnings or compiler errors.

Use the command **Options → Compatibility** to get into the following dialog:

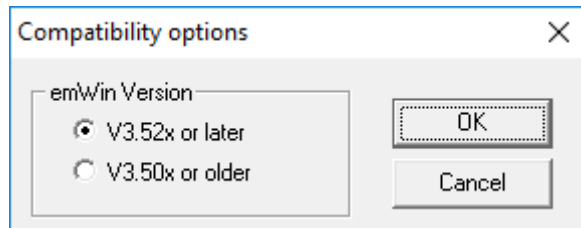

### Magnification options

The Font Converter is able to save the font data in a magnified format. Use the command **Options → Magnification** to get into the following dialog:

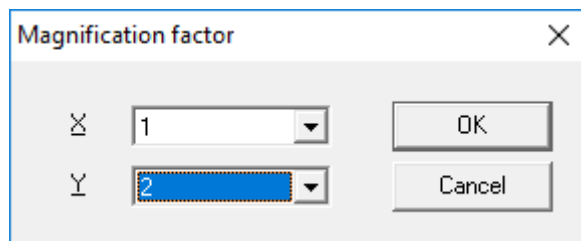

A magnification factor for the X and the Y axis can be specified here. If for example the magnification factor for the Y axis is 2 and the height of the current font data is 18, the font height in the font file will be 36. The magnification in X works similar. After saving the font in a magnified format a short message is shown to inform the user, that the saved font is magnified:

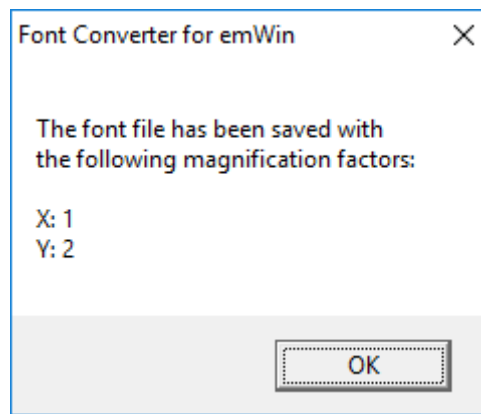

## Logging

Logging of commands can be enabled or disabled using the command **Options → Logging**:

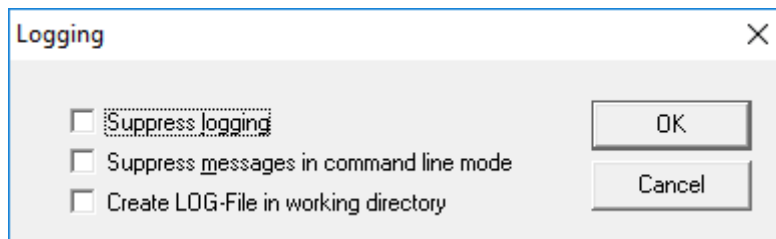

When logging is enabled the C files contain a history of the commands which has been used to modify the font file.

## Antialiasing

When using 'Internal anti-aliasing' it is recommended to enable `Suppress optimization`. This makes sure, that the horizontal and vertical alignment of the characters fit to each other:

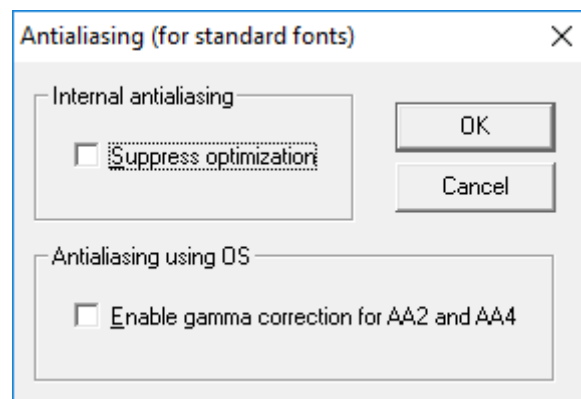

The option `Enable gamma correction for AA2 and AA4` should be disabled. When the option is enabled the anti-aliased pixels of the characters will appear a little more darker.

## 8.4.7 Saving the font

The Font Converter can create C font files or system independent font data files. Details about the SIF format can be found under *System Independent Font (SIF) format* on page 528.

### 8.4.7.1 Creating a C file

When you are ready to generate a C file, simply select **File → Save As** from the Font Converter menu, specify a destination and name for the file, choose the C file format and click **Save**. A C file will automatically be created.

The default setting for the filename is built by the name of the source font and the current height in pixels. For example, if the name of the source font is "Example" and the pixel height is 10, the default filename would be `Example10.c`. If you keep this default name when generating a C file, the resulting name of the font will be `GUI_FontExample10.c`.

Examples of C files generated from fonts can be found in the sub chapter *Font Examples* on page 2850.

### 8.4.7.2 Creating a System Independent Font (SIF)

When you are ready to generate the file, simply select **File → Save As** from the Font Converter menu, specify a destination and name for the file, choose the System independent font format and click **Save**. A system independent font file will automatically be created.

This file does not contain C structures which can be compiled with emWin but binary font data, which can be used as described in *System Independent Font (SIF) format* on page 528.

### 8.4.7.3 Creating an External Binary Font (XBF)

When you are ready to generate the file, simply select **File → Save As** from the Font Converter menu, specify a destination and name for the file, choose the External binary font format and click **Save**. An external binary font file will automatically be created.

This file does not contain C structures which can be compiled with emWin but binary font data, which can be used as described in *External Bitmap Font (XBF) format* on page 529.

## 8.4.8 Loading and modifying a C font file

The Font Converter is able to open existing font files and to modify their font data. The tool can only open C font files generated by the Font Converter. If the C font files have been modified manually, it can not be guaranteed, that they can be opened by the Font Converter.

### Step 1: Starting the application

The Font Converter is opened and automatically displays the Font generation options dialog box. In order to load an existing C font file, the "Font generation options" dialog should be closed.

### Step 2: Loading an existing C file

The desired C font file can be opened by selecting **File → Load 'C' file...** entry in the menu bar. The "Select 'C' file" dialog can be used to navigate through the file system in order to chose a 'C' font file which was previously created using the Font Converter. Not all of the font files which are shipped with emWin were created using the Font Converter. According to that not all of those can be reused.

## 8.4.9 Loading Glyph (B)itmap (D)istribution (F)ormat

That standard has been defined by Adobe 1993. Because there exist a large number of fonts that format, mainly in the Unix-world, the FontConverter has an option for loading BDF font files. That can be done by selecting **File → Load 'BDF' file....**



### 8.4.10 Merging fonts with existing C font files

The Font Converter is able to add the content of an existing C font file to the current font data. Once a font is loaded via **File → Load 'C' file...** or created by **File → New** a C font file can be merged to it using **File → Merge 'C' file....** The Font Converter requires the fonts to be of the same size, so the merging can be processed properly.

#### Step 1: Loading an existing font or creating a new one

This step was already described in previous sections. In this example the existing font contains the characters A-F (0x41 - 0x46).

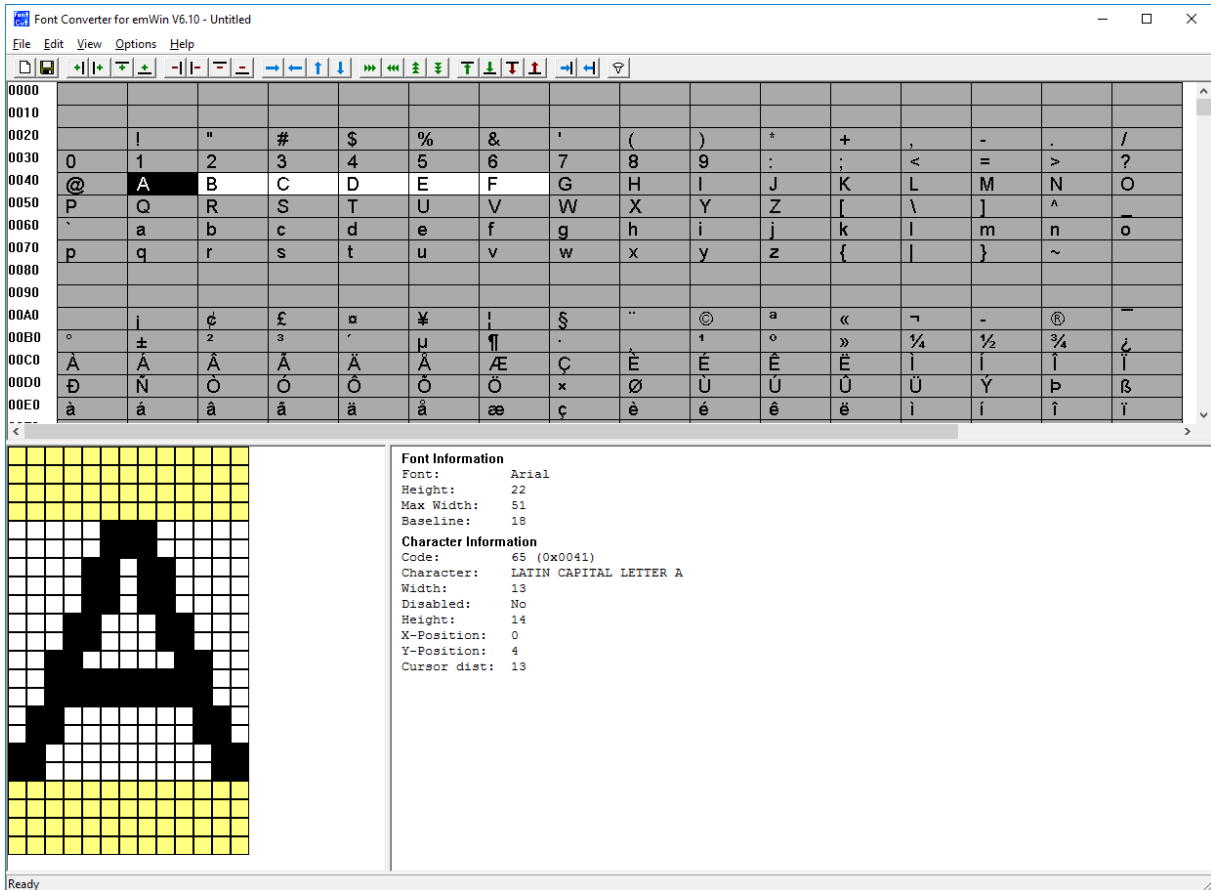

#### Step 2: Merging a C file

The desired C font file can be merged by selecting **File → Merge 'C' file...** entry in the menu bar. The *Select 'C' file* dialog can be used to navigate through the file system in order to chose a C font file to merge which was previously created using the Font Converter. Not all of the font files which are shipped with emWin were created using the Font Converter. According to that not all of those can be reused.

The characters included in the merged font will be shown and enabled. In this example the characters a-f (0x61 - 0x66) are merged to the existing font. The resulting font can be edited and saved as a new font file.

Font Converter for emWin V6.10 - Arial22

File Edit View Options Help

0000  
0010  
0020 | " # \$ % & ' ( ) \* + , - . /  
0030 0 1 2 3 4 5 6 7 8 9 : ; < = > ?  
0040 @ A B C D E F G H I J K L M N O  
0050 P Q R S T U V W X Y Z [ \ ] ^ \_  
0060 ` a b c d e f g h i j k l m n o  
0070 p q r s t u v w x y z { | } ~  
0080  
0090  
00A0 ¡ ¢ £ ¤ ¥ ¦ § ¨ © ª « ¬ ® ¯  
00B0 ° ± ² ³ ´ µ ¶ · ¸ ¹ º » ¼ ½ ¾ ¿  
00C0 À Á Â Ã Ä Å Æ Ç È É Ê Ë Ì Í Î Ï  
00D0 Ð Ñ Ò Ó Ô Õ Ö × Ø Ù Ú Û Ü Ý Þ ß  
00E0 à á â ã ä å æ ç è é ê ë ì í î ï

Font Information  
Font: Arial  
Height: 22  
Max Width: 51  
Baseline: 18

Character Information  
Code: 97 (0x0061)  
Character: LATIN SMALL LETTER A  
Width: 9  
Disabled: No  
Height: 10  
X-Position: 1  
Y-Position: 8  
Cursor dist: 10

Ready

## 8.4.11 Pattern files

In order not having to enable every single required character manually, pattern files can be used. Pattern files are simple text files, including the text which has to be displayed in the application. They need to be saved in Unicode format (LE) including a BOM (Byte Order Mark) at the beginning.

### 8.4.11.1 Creating pattern files using Notepad

One option for creating a pattern file is to use Notepad, which is part of the Windows accessories:

- Copy the text you want to display into the clipboard.
- Open Notepad.exe.
- Insert the contents of the clipboard into the Notepad document.
- Use **Format → Font** to choose a font which contains all characters of the text. You can skip this step if you do not want to see the characters.
- Use **File → Save As** to save the pattern file. It is very important that you save the file in text format:

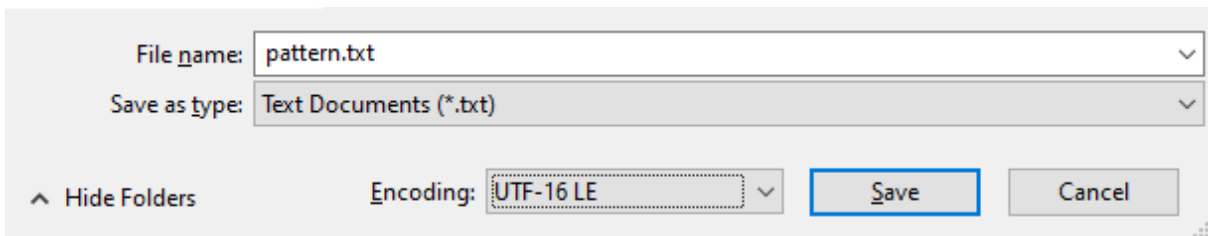

### 8.4.11.2 Creating pattern files using the Font Converter

A pattern file may also be created directly in the Font Converter. Select **Edit → Save pattern file** from the menu to create a text file which includes all currently enabled characters.

### 8.4.11.3 Enabling characters using a pattern file

It is usually helpful to begin by disabling all characters. Select **Edit → Disable all characters** from the menu if you need to do so. Now choose **Edit → Read pattern file**. After opening the appropriate pattern file, all characters included in the file are enabled. If the pattern file contains characters which are not included in the currently loaded font, a message box will appear.

## 8.4.12 Command line options

### 8.4.12.1 Table of commands

The following table shows the available command line options:

| Command   | Description  |
|---|--|
| <pre>create&lt;FONTNAME&gt;, &lt;STYLE&gt;, &lt;HEIGHT&gt;, &lt;TYPE&gt;, &lt;ENCODING&gt;[ , &lt;METHOD&gt;]</pre> | <p>Create font:</p> <p>&lt;FONTNAME&gt; Name of the font to be used</p> <p>&lt;STYLE&gt;</p> <p>THIN - Creates a thin font</p> <p>THIN_ITALIC - Creates a thin italic font</p> <p>EXTRALIGHT - Creates an extra light font</p> <p>EXTRALIGHT_ITALIC - Creates an extra light italic font</p> <p>LIGHT - Creates a light font</p> <p>LIGHT_ITALIC - Creates a light italic font</p> <p>REGULAR - Creates a regular font</p> <p>REGULAR_ITALIC - Creates a regular italic font</p> <p>MEDIUM - Creates a medium font</p> <p>MEDIUM_ITALIC - Creates a medium italic font</p> |

| Command  | Description   |
|--|---|
|  | <p>SEMIBOLD - Creates a semi bold font<br/>                     SEMIBOLD_ITALIC - Creates a semi bold italic font<br/>                     BOLD - Creates a bold font<br/>                     BOLD_ITALIC - Creates a bold italic font<br/>                     EXTRABOLD - Creates an extra bold font<br/>                     EXTRABOLD_ITALIC - Creates an extra bold italic font<br/>                     HEAVY - Creates a heavy font<br/>                     HEAVY_ITALIC - Creates a heavy italic font<br/>                     &lt;HEIGHT&gt; Height in pixels of the font to be created<br/>                     &lt;TYPE&gt;<br/>                     STD - Standard 1 bpp font<br/>                     AA2 - Anti-aliased font (2bpp)<br/>                     AA4 - Anti-aliased font (4bpp)<br/>                     EXT - Extended font<br/>                     EXT_FRM - Extended framed font<br/>                     EXT_AA2 - Extended font using 2bpp anti-aliasing<br/>                     EXT_AA4 - Extended font using 4bpp anti-aliasing<br/>                     &lt;ENCODING&gt;<br/>                     UC16 - 16 bit Unicode encoding<br/>                     ISO8859 - 8 bit ASCII + ISO8859<br/>                     JIS - Shift JIS<br/>                     &lt;METHOD&gt;<br/>                     OS - Antialiasing of operating system (default)<br/>                     INTERNAL - Internal anti-aliasing method</p> |
| <p>edit&lt;ACTION&gt;,<br/>                     &lt;DETAIL&gt;[ ,&lt;CNT&gt; ]</p>       | <p>Equivalent to the 'Edit' menu (font dependent):<br/>                     &lt;ACTION&gt;<br/>                     DEL - Deletes pixels<br/>                     INS - Inserts pixels<br/>                     &lt;DETAIL&gt;<br/>                     TOP - Delete/insert from top<br/>                     BOTTOM - Delete/insert from bottom<br/>                     &lt;CNT&gt; - Number of operations, default is 1</p>  |
| <p>edit&lt;ACTION&gt;,<br/>                     &lt;FIRST[-LAST]&gt; , &lt;VALUE&gt;</p> | <p>Equivalent to the 'Edit' menu (current character dependent):<br/>                     &lt;ACTION&gt;<br/>                     CINC - Increments the cursor distance for the given range (only positive values are allowed)<br/>                     CDEC - Decrements the cursor distance for the given range (only positive values are allowed)<br/>                     SHIFTH - Shifts the character range by n-pixels (VALUE, if negative it's left)<br/>                     SHIFTV - Shifts the character range by n-pixels (VALUE, if negative it's up)<br/>                     MOVEH - Moves the character range by n-pixels (VALUE, if negative it's left)<br/>                     MOVEV - Moves the character range by n-pixels (VALUE, if negative it's up)<br/>                     INST - Insert n-rows to the top of the character range<br/>                     INSB - Insert n-rows to the bottom of the character range<br/>                     INSL - Insert n-columns to the left of the character range<br/>                     INSR - Insert n-columns to the right of the character range<br/>                     DELT - Delete n-rows to the top of the character range<br/>                     DELB - Delete n-rows to the bottom of the character range<br/>                     DELL - Delete n-columns to the left of the character range</p>  |

| Command                     | Description   |
|-----------------------------|---|
|                             | DELR - Delete n-columns to the right of the character range<br><FIRST[-LAST]><br>Hexadecimal value(s) separated by a '-' defining the range of characters<br><VALUE><br>Value to be used for the given action       |
| enable[FIRST-LAST>, <STATE> | Enables or disables the given range of characters:<br><FIRST-LAST> Hexadecimal values separated by a '-' defining the range of characters<br><STATE><br>1 - Enables the given range<br>0 - Disables the given range |
| exit                        | Exits the application after the job was done.   |
| merge<FILENAME>             | Merges the given C file to the current content.   |
| readpattern<FILENAME>       | Reads a pattern file:<br><FILENAME> Name of the pattern file to be read   |
| saveas<FILENAME>, <TYPE>    | Saves the font data in a specific format:<br><FILENAME> File name including extension<br><TYPE><br>C - Saves as C file<br>SIF - Saves as System independent font file<br>XBF - Saves as external binary font file   |
| ?                           | Shows all available commands.   |

### Note

- All commands are processed from left to right.
- If using `-exit` Font Converter will stop execution if an error occurs. The return code in this case is  $\neq 0$ .

## 8.4.12.2 Load an existing font file

To load an already existing font, present as c- or xbf-file, call the FontConvert with the filename as first parameter.

```
FonCvt FontFile.xbf
```

## 8.4.12.3 Execution examples

```
FontCvt -create"Cordia New",BOLD,32,EXT,UC16
```

Creates an extended bold font of 32 pixels height with Unicode encoding using the font "Cordia New".

```
FontCvt FontFile.c -enable0-ffff,0 -readpattern"data.txt"
```

Reads the C font file `FontFile.c`, disables all characters and reads a pattern file.

## 8.4.13 Font Examples

This section provides examples of C files generated by the Font Converter in standard, 2bpp anti-aliased and 4bpp anti-aliased mode, respectively.

### 8.4.13.1 Resulting C code, standard mode

The following is an example of a C file in standard mode:

```

/*
  C-file generated by Font Converter for emWin version 3.04
  Compiled:      Dec 13 2005 at 12:51:50
  C-file created: Dec 21 2005 at 12:42:57
  Copyright (C) 1998-2005
  Segger Microcontroller Systeme GmbH
  www.segger.com
  Solutions for real time microcontroller applications
  Source file: Sample10.c
  Font:         Arial
  Height:       10
*/
#include "GUI.H"
#ifndef GUI_CONST_STORAGE
#define GUI_CONST_STORAGE const
#endif
/* The following line needs to be included in any file selecting the
   font. A good place would be GUIConf.H
*/
extern GUI_CONST_STORAGE GUI_FONT GUI_FontSample10;
/* Start of unicode area <Basic Latin> */
GUI_CONST_STORAGE unsigned char acFontSample10_0041[10] = { /* code 0041 */
    _____,
    _X_____,
    _X_X____,
    _X_X____,
    _X_X____,
    _X_X_X__,
    _XXXXX__,
    X____X_,
    X____X_,
    _____};
GUI_CONST_STORAGE unsigned char acFontSample10_0061[10] = { /* code 0061 */
    _____,
    _____,
    _____,
    _XXX____,
    X__X____,
    _XXXX____,
    X__X____,
    X__XX____,
    _XX_X____,
    _____};
GUI_CONST_STORAGE GUI_CHARINFO GUI_FontSample10_CharInfo[2] = {
    { 8, 8, 1, acFontSample10_0041 } /* code 0041 */
    , { 6, 6, 1, acFontSample10_0061 } /* code 0061 */
};
GUI_CONST_STORAGE GUI_FONT_PROP GUI_FontSample10_Prop2 = {
    97 /* first character */
    , 97 /* last character */
    , &GUI_FontSample10_CharInfo[1] /* address of first character */
    , (GUI_CONST_STORAGE GUI_FONT_PROP*)0 /* pointer to next GUI_FONT_PROP */
};
GUI_CONST_STORAGE GUI_FONT_PROP GUI_FontSample10_Prop1 = {
    65 /* first character */
    , 65 /* last character */
    , &GUI_FontSample10_CharInfo[0] /* address of first character */
    , &GUI_FontSample10_Prop2 /* pointer to next GUI_FONT_PROP */
};

```

```

};
GUI_CONST_STORAGE GUI_FONT GUI_FontSample10 = {
    GUI_FONTTYPE_PROP /* type of font */
    ,10                /* height of font */
    ,10                /* space of font y */
    ,1                 /* magnification x */
    ,1                 /* magnification y */
    ,&GUI_FontSample10_Propl
};

```

### 8.4.13.2 Resulting C code, 2 bpp anti-aliased mode

The following is an example of a C file in 2 bpp anti-aliased mode:

```

/*
C-file generated by Font Converter for emWin version 3.04
Compiled:      Dec 13 2005 at 12:51:50
C-file created: Dec 21 2005 at 12:42:57
Copyright (C) 1998-2005
Segger Microcontroller Systeme GmbH
www.segger.com
Solutions for real time microcontroller applications
Source file: Sample10.c
Font:         Arial
Height:       14
*/
#include "GUI.H"
#ifndef GUI_CONST_STORAGE
#define GUI_CONST_STORAGE const
#endif
/* The following line needs to be included in any file selecting the
font. A good place would be GUIConf.H
*/
extern GUI_CONST_STORAGE GUI_FONT GUI_FontSample10;
/* Start of unicode area <Basic Latin> */
GUI_CONST_STORAGE unsigned char acFontSample10_0041[ 28] = { /* code 0041 */
    0x00, 0x00,
    0x00, 0x00,
    0x00, 0x00,
    0x0B, 0xC0,
    0x1F, 0xD0,
    0x2E, 0xE0,
    0x3C, 0xF0,
    0x78, 0xB4,
    0xBF, 0xF8,
    0xE0, 0x78,
    0xE0, 0x3C,
    0x00, 0x00,
    0x00, 0x00,
    0x00, 0x00
};
GUI_CONST_STORAGE unsigned char acFontSample10_0061[ 28] = { /* code 0061 */
    0x00, 0x00,
    0x00, 0x00,
    0x00, 0x00,
    0x00, 0x00,
    0x00, 0x00,
    0x6F, 0x40,
    0x93, 0xC0,
    0x2B, 0xC0,
    0xB7, 0xC0,
    0xF7, 0xC0,
    0x7B, 0xC0,
    0x00, 0x00,
    0x00, 0x00,
    0x00, 0x00
};
};

```

```

GUI_CONST_STORAGE GUI_CHARINFO GUI_FontSample10_CharInfo[2] = {
    { 8, 8, 2, acFontSample10_0041 } /* code 0041 */
, { 6, 6, 2, acFontSample10_0061 } /* code 0061 */
};
GUI_CONST_STORAGE GUI_FONT_PROP GUI_FontSample10_Prop2 = {
    0x0061 /* first character */
, 0x0061 /* last character */
, &GUI_FontSample10_CharInfo[ 1] /* address of first character */
, (GUI_CONST_STORAGE GUI_FONT_PROP*)0 /* pointer to next GUI_FONT_PROP */
};
GUI_CONST_STORAGE GUI_FONT_PROP GUI_FontSample10_Prop1 = {
    0x0041 /* first character */
, 0x0041 /* last character */
, &GUI_FontSample10_CharInfo[ 0] /* address of first character */
, &GUI_FontSample10_Prop2 /* pointer to next GUI_FONT_PROP */
};
GUI_CONST_STORAGE GUI_FONT GUI_FontSample10 = {
    GUI_FONTTYPE_PROP_AA2 /* type of font */
, 14 /* height of font */
, 14 /* space of font y */
, 1 /* magnification x */
, 1 /* magnification y */
, &GUI_FontSample10_Prop1
};

```

### 8.4.13.3 Resulting C code, 4 bpp anti-aliased mode

The following is an example of a C file in 4 bpp anti-aliased mode:

```

/*
C-file generated by Font Converter for emWin version 3.04
Compiled:      Dec 13 2005 at 12:51:50
C-file created: Dec 21 2005 at 12:42:57
Copyright (C) 1998-2005
Segger Microcontroller Systeme GmbH
www.segger.com
Solutions for real time microcontroller applications
Source file: Sample10.c
Font:         Arial
Height:       10
*/
#include "GUI.H"
#ifndef GUI_CONST_STORAGE
#define GUI_CONST_STORAGE const
#endif
/* The following line needs to be included in any file selecting the
font. A good place would be GUIConf.H
*/
extern GUI_CONST_STORAGE GUI_FONT GUI_FontSample10;
/* Start of unicode area <Basic Latin> */
GUI_CONST_STORAGE unsigned char acFontSample10_0041[ 40] = { /* code 0041 */
    0x00, 0x00, 0x00, 0x00,
    0x00, 0xCF, 0xF2, 0x00,
    0x03, 0xFF, 0xF6, 0x00,
    0x09, 0xFB, 0xFB, 0x00,
    0x0E, 0xE2, 0xFE, 0x00,
    0x5F, 0x90, 0xCF, 0x40,
    0xBF, 0xFF, 0xFF, 0x90,
    0xFC, 0x00, 0x6F, 0xC0,
    0xF8, 0x00, 0x2F, 0xF2,
    0x00, 0x00, 0x00, 0x00
};
GUI_CONST_STORAGE unsigned char acFontSample10_0061[ 30] = { /* code 0061 */
    0x00, 0x00, 0x00,
    0x00, 0x00, 0x00,
    0x00, 0x00, 0x00,
    0x3D, 0xFE, 0x60,

```



```

0xD3, 0x0F, 0xE0,
0x29, 0xCF, 0xF0,
0xDF, 0x4F, 0xF0,
0xFF, 0x3F, 0xF0,
0x6F, 0xAF, 0xF0,
0x00, 0x00, 0x00
};
GUI_CONST_STORAGE GUI_CHARINFO GUI_FontSample10_CharInfo[2] = {
  { 8, 8, 4, acFontSample10_0041 } /* code 0041 */
, { 6, 6, 3, acFontSample10_0061 } /* code 0061 */
};
GUI_CONST_STORAGE GUI_FONT_PROP GUI_FontSample10_Prop2 = {
  0x0061 /* first character */
, 0x0061 /* last character */
, &GUI_FontSample10_CharInfo[ 1] /* address of first character */
, (GUI_CONST_STORAGE GUI_FONT_PROP*)0 /* pointer to next GUI_FONT_PROP */
};
GUI_CONST_STORAGE GUI_FONT_PROP GUI_FontSample10_Prop1 = {
  0x0041 /* first character */
, 0x0041 /* last character */
, &GUI_FontSample10_CharInfo[ 0] /* address of first character */
, &GUI_FontSample10_Prop2 /* pointer to next GUI_FONT_PROP */
};
GUI_CONST_STORAGE GUI_FONT GUI_FontSample10 = {
  GUI_FONTTYPE_PROP_AA4 /* type of font */
, 10 /* height of font */
, 10 /* space of font y */
, 1 /* magnification x */
, 1 /* magnification y */
, &GUI_FontSample10_Prop1
};

```

### 8.4.13.4 Resulting C code, extended mode

```

/*
C-file generated by Font Converter for emWin version 3.04
Compiled:      Dec 13 2005 at 12:51:50
C-file created: Dec 21 2005 at 12:45:52
Copyright (C) 1998-2005
Segger Microcontroller Systeme GmbH
www.segger.com
Solutions for real time microcontroller applications
Source file: Arial16.c
Font:         Arial
Height:       16
*/
#include "GUI.H"
#ifndef GUI_CONST_STORAGE
#define GUI_CONST_STORAGE const
#endif
/* The following line needs to be included in any file selecting the
font. A good place would be GUIConf.H
*/
extern GUI_CONST_STORAGE GUI_FONT GUI_Font16;
/* Start of unicode area <Basic Latin> */
GUI_CONST_STORAGE unsigned char acGUI_Font16_0041[ 20] = { /* code 0041 */
  _X_, _____,
  _X_X_, _____,
  _X_X_, _____,
  _X_X_, _____,
  _X_X_, _____,
  _X_X_, _____,
  _XXXXXXX, _____,
  _X_X_, _____,
  X_____, X_____,
  X_____, X_____};

```

```

GUI_CONST_STORAGE unsigned char acGUI_Font16_0061[ 7] = { /* code 0061 */
  _XXX_,
  X__X__,
  __X__,
  _XXXX_,
  X__X__,
  X__XX_,
  _XX_X_};
GUI_CONST_STORAGE GUI_CHARINFO_EXT GUI_Font16_CharInfo[2] = {
  { 9, 10, 0, 3, 9, acGUI_Font16_0041 } /* code 0041 */
, { 5, 7, 1, 6, 7, acGUI_Font16_0061 } /* code 0061 */
};
GUI_CONST_STORAGE GUI_FONT_PROP_EXT GUI_Font16_Prop2 = {
  0x0061 /* first character */
, 0x0061 /* last character */
, &GUI_Font16_CharInfo[ 1] /* address of first character */
, (GUI_CONST_STORAGE GUI_FONT_PROP_EXT *)0
};
GUI_CONST_STORAGE GUI_FONT_PROP_EXT GUI_Font16_Prop1 = {
  0x0041 /* first character */
, 0x0041 /* last character */
, &GUI_Font16_CharInfo[ 0] /* address of first character */
, &GUI_Font16_Prop2 /* pointer to next GUI_FONT_PROP_EXT */
};
GUI_CONST_STORAGE GUI_FONT GUI_Font16 = {
  GUI_FONTTYPE_PROP_EXT /* type of font */
, 16 /* height of font */
, 16 /* space of font y */
, 1 /* magnification x */
, 1 /* magnification y */
, {&GUI_Font16_Prop1}
, 13 /* Baseline */
, 7 /* Height of lowercase characters */
, 10 /* Height of capital characters */
};

```

## 8.4.14 Troubleshooting

MS Windows 7 by default shows only fonts which match the computers language settings. If it is required to create a font for other languages, the required Windows fonts might not be shown in the 'Font' dialog. This is caused by the MS Windows font settings. In order to change those settings, the following 'Control Panel' path should be opened:

```
Control Panel\All Control Panel Items\Fonts\Font settings
```

Once the checkbox "Hide fonts based on language settings" is checked, all Windows fonts installed on the computer should be shown in the 'Font' dialog.

For calculating the baseline of a font it is required that the letter 'a' is present in the Font.

# 8.5 emWinSPY

emWinSPY is designed for showing runtime information of the embedded target on a PC. It shows information about the currently connected emWin application like memory status, a tree with detailed information about all currently existing windows and a list of user input, which optionally can be written into a log file. Further it is able to take screenshots of the current screen. Communication works via a socket connection (TCP/IP) or Segger’s Real Time Transfer (RTT), a technology explained in detail on [our website](#).

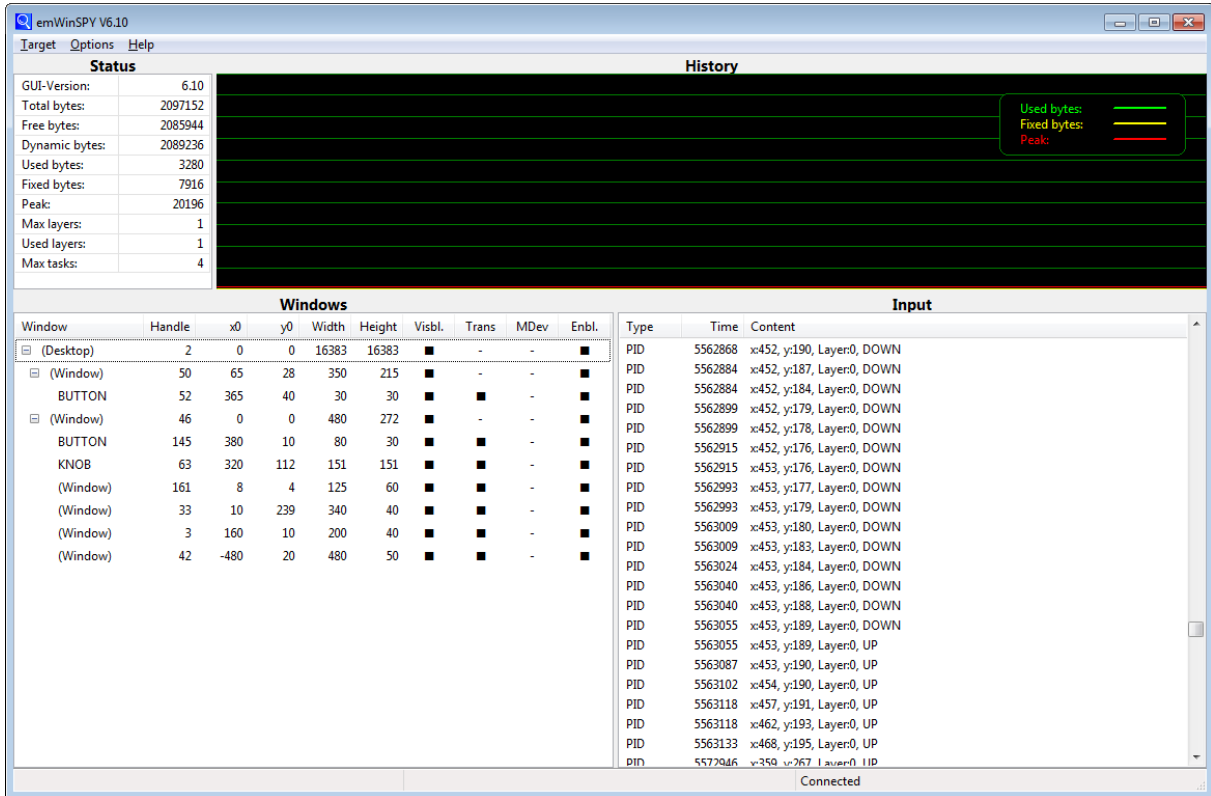

## 8.5.1 Introduction

The emWinSPY consists of two types of components: A server on application side, which is responsible for supplying data, and the emWinSPY viewer, which requests and shows that data. Server and viewer may be on different machines and on different architectures. The communication between server and viewer could be achieved via a socket connection (TCP/IP) or via Segger’s Real Time Transfer (RTT). RTT is a technology for interactive user I/O in embedded applications.

### 8.5.1.1 Requirements

#### RTT

If a J-Link debug probe and RTT is available on the used system, the communication could be achieved over an RTT connection. To be able to use RTT the free available RTT-code needs to be added to the project, which is available on our website:

[www.segger.com/jlink-rtt.html](http://www.segger.com/jlink-rtt.html)

#### TCP/IP stack

Alternatively the communication between server and viewer could be achieved by a socket connection. In that case a TCP/IP stack is required. In the Win32 simulation environment, TCP/IP (Winsock) is normally present. On the target hardware a TCP/IP stack needs to be present. The TCP/IP stack is NOT part of emWin. The flexible interface ensures that any TCP/IP stack can be used.

## Multi tasking

The emWinSPY server needs to run as a separate thread. Therefore a multi tasking system is required.

## Compile-time configuration

Support for emWinSPY needs to be enabled using the following definition in GUIConf.h:

```
#define GUI_SUPPORT_SPY 1
```

### 8.5.1.2 Availability

Currently emWinSPY (server and viewer) is part of the basic package. It is also available in the emWin simulation and trial version.

## 8.5.2 Starting the emWinSPY server...

### 8.5.2.1 ...in the simulation environment

The only thing to be done here is calling `GUI_SPY_StartServer()`. In the simulation environment that function automatically starts an emWinSPY server thread which waits on port 2468 for an incoming connection.

### 8.5.2.2 ...on the target hardware

Starting the server on the target hardware works exactly the same as in the simulation by calling `GUI_SPY_StartServer()`. But whereas the simulation already contains a routine for starting the server, that routine needs to be supplied by the application on hardware side. The routine to be added is `GUI_SPY_X_StartServer()`.

### 8.5.2.3 GUI\_SPY\_X\_StartServer

The challenge of the routine is creating a task which executes the actual server `GUI_SPY_Process()`. The way how that could be achieved depends on the used communication method.

#### Example

emWin comes with a ready to use sample for that function. It could be found in the sample folder: `Sample\GUI_X\GUI_SPY_X_StartServer.c`.

That sample contains a ready to use implementation to be used with JLink RTT and/or embOS/IP. It is easily adaptable to any IP-stack and any RTOS.

#### Prototype

```
int GUI_SPY_X_StartServer(void);
```

## 8.5.3 The emWinSPY viewer

### 8.5.3.1 The screen

The screen of the viewer is divided into 4 areas:

| Area    | Description  |
|---------|--|
| Status  | Major purpose is showing the current state of memory allocation. |
| History | History of memory allocation.                                    |
| Windows | Shows a tree of all existing windows.                            |
| Input   | List of user interface input: Keyboard, Touch and MTouch         |

### 8.5.3.1.1 Status area

| Status         |         |
|----------------|---------|
| GUI-Version:   | 6.10    |
| Total bytes:   | 2097152 |
| Free bytes:    | 2085944 |
| Dynamic bytes: | 2089236 |
| Used bytes:    | 3280    |
| Fixed bytes:   | 7916    |
| Peak:          | 20196   |
| Max layers:    | 1       |
| Used layers:   | 1       |
| Max tasks:     | 4       |

The table below shows the information of the status area:

| Item          | Description   |
|---------------|---|
| GUI-Version   | Used GUI-Version of emWin application                 |
| Total bytes   | Total bytes of memory available for emWin             |
| Free bytes    | Remaining free bytes                                  |
| Dynamic bytes | Number of bytes currently allocated dynamically       |
| Fixed bytes   | Number of bytes used by fixed allocation              |
| Peak          | Maximum number of bytes used (fixed + dynamic)        |
| Max layers    | Maximum number of layers configured by GUI_NUM_LAYERS |
| Used layers   | Number of layers used with current configuration.     |
| Max tasks     | Maximum number of GUI-tasks                           |

### Fixed bytes / Dynamic bytes



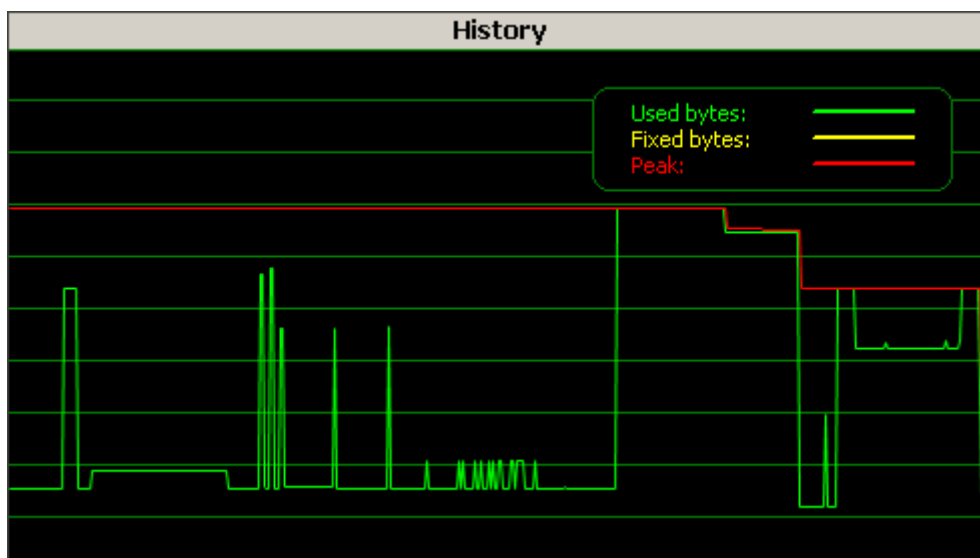

The memory management of emWin uses 2 kinds of memory allocation: dynamic allocated memory and fixed blocks. Dynamically allocated memory can be freed and reused for further dynamic allocation operations. A fixed memory block is no longer available for dynamic memory allocation. Once a fixed memory block is allocated, that block could not be used for dynamic allocation. Examples for fixed memory blocks are driver caches or conversion buffers.

### 8.5.3.1.2 History area



It shows the changes of used bytes, fixed bytes and memory peak in the course of time. The history remains after disconnecting and reconnecting. A context menu available with a right click allows clearing the history.

### 8.5.3.1.3 Windows area

| Windows   |        |     |     |       |        |        |       |      |       |  |
|---|--------|-----|-----|-------|--------|--------|-------|------|-------|--|
| Window  | Handle | x0  | y0  | Width | Height | Visbl. | Trans | MDev | Enbl. |  |
|  (Desktop)       | 2      | 0   | 0   | 16383 | 16383  | ■      | -     | ■    | ■     |  |
|  FRAMEWIN        | 5      | 240 | 179 | 80    | 61     | ■      | -     | -    | ■     |  |
|  FRAMEWIN-CLIENT | 6      | 245 | 192 | 70    | 44     | ■      | -     | ■    | ■     |  |
| BUTTON  | 4      | 247 | 216 | 32    | 20     | ■      | ■     | ■    | ■     |  |
| BUTTON  | 10     | 281 | 216 | 32    | 20     | ■      | ■     | ■    | ■     |  |
| PROGBAR   | 12     | 247 | 203 | 66    | 12     | ■      | -     | ■    | ■     |  |
| TEXT  | 14     | 247 | 194 | 69    | 7      | ■      | ■     | ■    | ■     |  |
|  FRAMEWIN        | 16     | 160 | 0   | 160   | 65     | -      | -     | -    | ■     |  |
|  FRAMEWIN-CLIENT | 17     | 165 | 13  | 150   | 48     | ■      | -     | ■    | ■     |  |
| TEXT  | 19     | 168 | 16  | 150   | 48     | ■      | ■     | ■    | ■     |  |

That screen contains a tree of all currently existing windows with some additional information about their current states. The following table shows the available information:

| Column       | Description  |
|--------------|--|
| Window       | Type of window.  |
| Handle       | The handle of the window.  |
| x0/y0        | Position of the window in screen coordinates.                        |
| Width/Height | Size of the window.  |
| Visbl.       | Shows if the window (and its children) is visible or not.            |
| Trans        | Transparency flag of the window.                                     |
| MDev         | Shows if automatic use of memory devices is enabled for that window. |
| Enbl.        | Shows if the window is enabled or disabled.                          |

### 8.5.3.1.4 Input area

| Input  |       |  |
|--------|-------|--|
| Type   | Time  | Content  |
| PID    | 25873 | x:65, y:125, Layer:0, DOWN                                       |
| PID    | 27376 | x:155, y:150, Layer:0, UP  |
| PID    | 27676 | x:155, y:150, Layer:0, DOWN                                      |
| KEY    | 28678 | Key:17, UP   |
| KEY    | 28728 | Key:17, DOWN   |
| KEY    | 28778 | Key:17, UP   |
| KEY    | 28828 | Key:17, DOWN   |
| KEY    | 28878 | Key:17, UP   |
| KEY    | 28928 | Key:17, DOWN   |
| KEY    | 28978 | Key:17, UP   |
| KEY    | 29028 | Key:17, DOWN   |
| KEY    | 29078 | Key:13, UP   |
| KEY    | 29131 | Key:13, DOWN   |
| PID    | 29681 | x:65, y:100, Layer:0, UP   |
| PID    | 29981 | x:65, y:100, Layer:0, DOWN                                       |
| MTOUCH | 30621 | (x:187, y:57, Id:12, MOVE), (x:239, y:139, Id:13, DOWN), Layer:0 |
| PID    | 30621 | x:187, y:57, Layer:0, UP   |
| MTOUCH | 30628 | (x:187, y:57, Id:12, MOVE), (x:239, y:139, Id:13, MOVE), Layer:0 |
| PID    | 30628 | x:187, y:57, Layer:0, UP   |

That window shows the user interface input recognized by emWinSPY. The following table shows the available information:

| Column  | Description  |
|---------|--|
| Type    | PID: Pointer interface input<br>KEY: Keyboard input<br>MTOUCH: MultiTouch input  |
| Time    | Timestamp created on target side   |
| Content | PID: X- and Y-position, Layer, UP or DOWN<br>KEY: Keycode and UP or DOWN<br>MTOUCH: X- and Y-position, TP-Id and DOWN, MOVE or UP for each TP (TP: Touchpoint) |

### 8.5.3.2 Connecting to target

The connection parameters to be entered depend on the choice of communication.

#### Connecting via TCP/IP

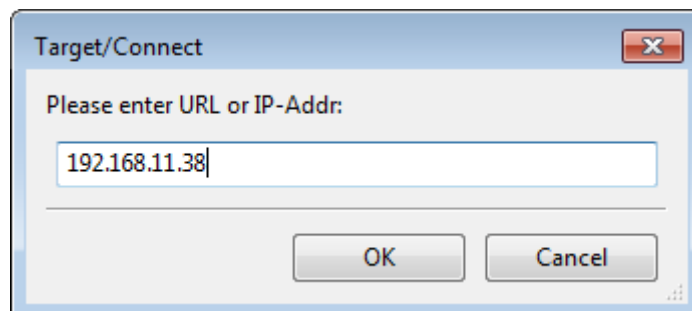

An URL or an IP-address could be used here. emWinSPY remembers the last used URL for the next connection.

## Connecting via RTT

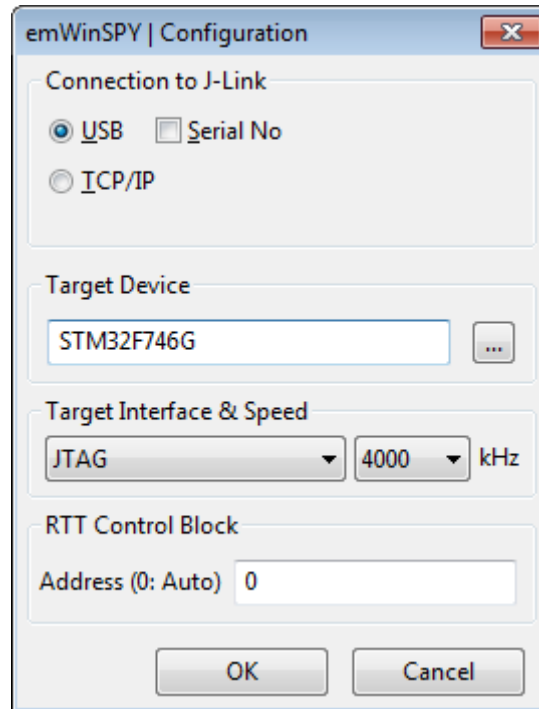

That dialog is required to enter the according parameters for an RTT connection. emWinSPY remembers the parameters for a further connection.

### 8.5.3.3 Configuration options

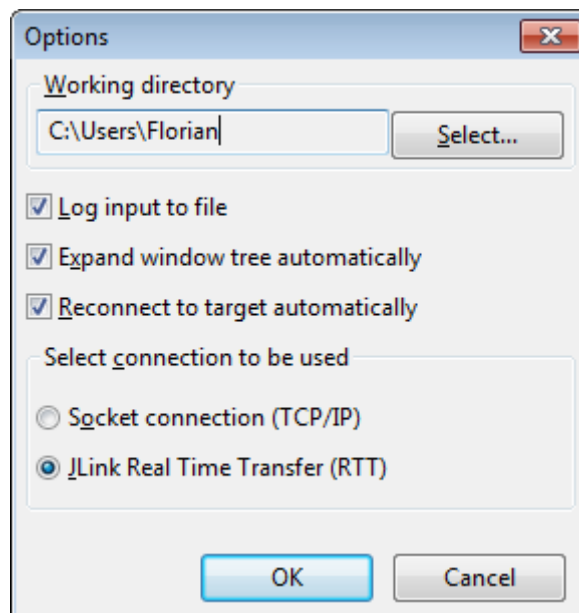

#### 'Working directory'

That folder is used for LOG-files and screenshots. The default value is the home directory of the current user.

#### 'Log input to file'

If logging is activated (default), all user interface input is written into a file. The filename is created automatically by using the current local time of the PC. The format is `YYYY_MM_DD_HH_MM_SS_MSEC.log`. For example `2014_12_16_15_04_44_0943.log` means the file was created at 12/2014 at 16:15 and 4 seconds. The last 4 digits contain the milliseconds. Each



time a connection is closed (or aborted) the file is be closed and a new one is created once the connection is established again.

### 'Expand window tree automatically'

If that option is active the nodes of the windows tree are automatically expanded.

### Reconnect to target automatically

If activated emWinSPY automatically tries to reconnect to a target after the connection has been closed.

### Select connection to be used

Select between RTT and socket connection.

## 8.5.3.4 Taking a screenshot from the target

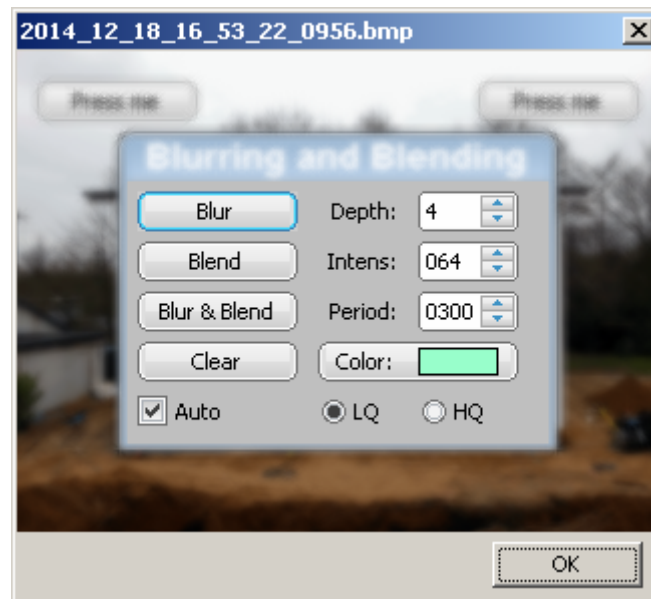

With the command **Target → Get screenshot** or by pressing **<CTRL> + <G>** a BMP-file containing the current content of the screen is created. The name of the file is created automatically by the same way as described under *Log input to file* above. Only the file extension is `.bmp` instead of `.log`. The screenshot can be found in the working directory.

## 8.5.4 emWinSPY API

The following table lists the emWinSPY related API functions.

| Routine                              | Description  |
|--------------------------------------|--|
| <code>GUI_SPY_Process()</code>       | Actual emWinSPY-server to be called from the server thread.  |
| <code>GUI_SPY_SetMemHandler()</code> | This function may be used to set a memory handler for the emWinSPY.  |
| <code>GUI_SPY_StartServer()</code>   | Starts the server thread by calling <code>GUI_SPY_X_StartServer()</code> .   |
| <code>GUI_SPY_StartServerEx()</code> | Starts the server thread by calling the given function pointer.  |
| <code>GUI_SPY_X_StartServer()</code> | Responsible for creating the actual server thread, establishing connections and calling <code>GUI_SPY_Process()</code> from the server thread. |

### 8.5.4.1 GUI\_SPY\_Process()

#### Description

That function is the actual server which supplies the emWinSPY with the requested information. Simply call that function from the server thread after establishing a connection.

#### Prototype

```
int GUI_SPY_Process(GUI_tSend  pfSend,
                   GUI_tRecv  pfRecv,
                   void        * pConnectInfo);
```

#### Parameters

| Parameter                 | Description  |
|---------------------------|--|
| <code>pfSend</code>       | Pointer to the function to be used by the server to send data to the emWinSPY.   |
| <code>pfRecv</code>       | Pointer to the function to be used by the server to read data from the emWinSPY. |
| <code>pConnectInfo</code> | Pointer to be passed to the send and receive function.                           |

#### Return value

0        after the connection has been closed properly.  
1        on error.

#### Additional information

The sample folder `Sample\GUI_X` contains a sample implementation of a server thread. It is located in the file `GUI_SPY_X_StartServer.c`.

#### Example

```
static int _Send(const U8 * buf, int len, void * p) {
    ...
}
static int _Recv(U8 * buf, int len, void * p) {
    ...
}
static int _ServerTask(void * p) {
    int Sock;
    ...
    GUI_SPY_Process(_Send, _Recv, (void *)Sock);
}
```

## 8.5.4.2 GUI\_SPY\_SetMemHandler()

### Description

This function may be used to set a memory handler for the emWinSPY. Some operations, especially collecting the windows information requires dynamic memory. That memory normally is allocated by using the emWin memory management system. With a separate memory manager (for example malloc and free) the server thread would not affect the dynamic memory manager.

### Prototype

```
void GUI_SPY_SetMemHandler(void * ( *pMalloc)(unsigned int ),  
                           void ( *pFree)(void * ));
```

### Parameters

| Parameter            | Description                           |
|----------------------|---------------------------------------|
| <code>pMalloc</code> | Pointer to memory allocation routine. |
| <code>pFree</code>   | Pointer to memory release function.   |

### Additional information

Using a separate memory manager is optional and not required.

### 8.5.4.3 GUI\_SPY\_StartServer()

#### Description

That function starts the server by calling `GUI_SPY_X_StartServer()` explained later and sets the required hook functions for gathering information.

#### Prototype

```
int GUI_SPY_StartServer(void);
```

#### Return value

|   |            |
|---|------------|
| 0 | on success |
| 1 | on error.  |

### 8.5.4.4 GUI\_SPY\_StartServerEx()

#### Description

This function starts the server by calling the function pointer passed to this function. With this function emWinSPY can be used, although GUI\_SUPPORT\_SPY is set to zero.

#### Prototype

```
int GUI_SPY_StartServerEx(int ( *pGUI_SPY_X_StartServer)());
```

#### Parameters

| Parameter                           | Description   |
|-------------------------------------|---|
| <code>pGUI_SPY_X_StartServer</code> | Pointer to a function which starts the SPY server. Same as <code>GUI_SPY_X_StartServer()</code> . |

#### Return value

- 0 on success
- 1 on error.

### 8.5.4.5 GUI\_SPY\_X\_StartServer()

#### Description

That function actually is responsible for creating the server thread and establishing a connection. When running the simulation it already contains an implementation of that function. When running on hardware that function has to be supplied by the customer.

#### Prototype

```
int GUI_SPY_X_StartServer(void);
```

#### Return value

0        on success  
1        on error.

#### Additional information

As already mentioned earlier the sample folder `Sample\GUI_X` contains a sample implementation of a server thread. It is located in the file `GUI_SPY_X_StartServer.c` and is written to be used with embOS/IP. In case of using different tools it should be an easy task to adapt that sample.

# 8.6 GUI Builder

## Note

Since the release of the **AppWizard** tool, the GUI Builder is considered an obsolete tool. More information about AppWizard can be found in the chapter *AppWizard* on page 80.

The GUIBuilder application is a tool for creating dialogs without any knowledge of the C programming language. Instead of writing source code the widgets can be placed and sized by drag and drop. Additional properties can be added per context menu. Fine tuning can be done by editing the properties of the widgets. This does not require any knowledge of the C programming language. The dialogs can be saved as C files which can be enhanced by adding user defined code. Of course these C files with the embedded user code can be loaded and modified by the GUIBuilder.

## Screenshot

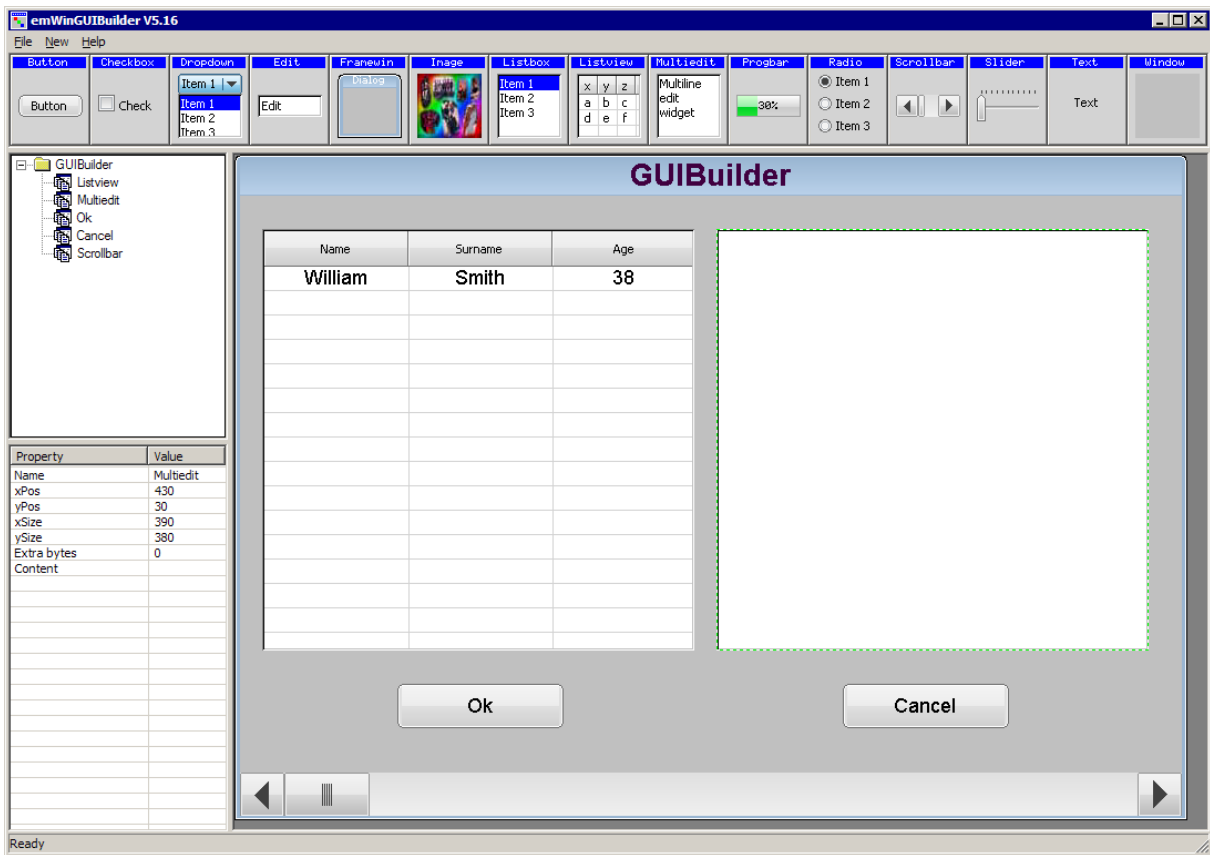

### 8.6.1 Introduction

The following diagram shows the elements of the graphical user interface of the GUIBuilder:

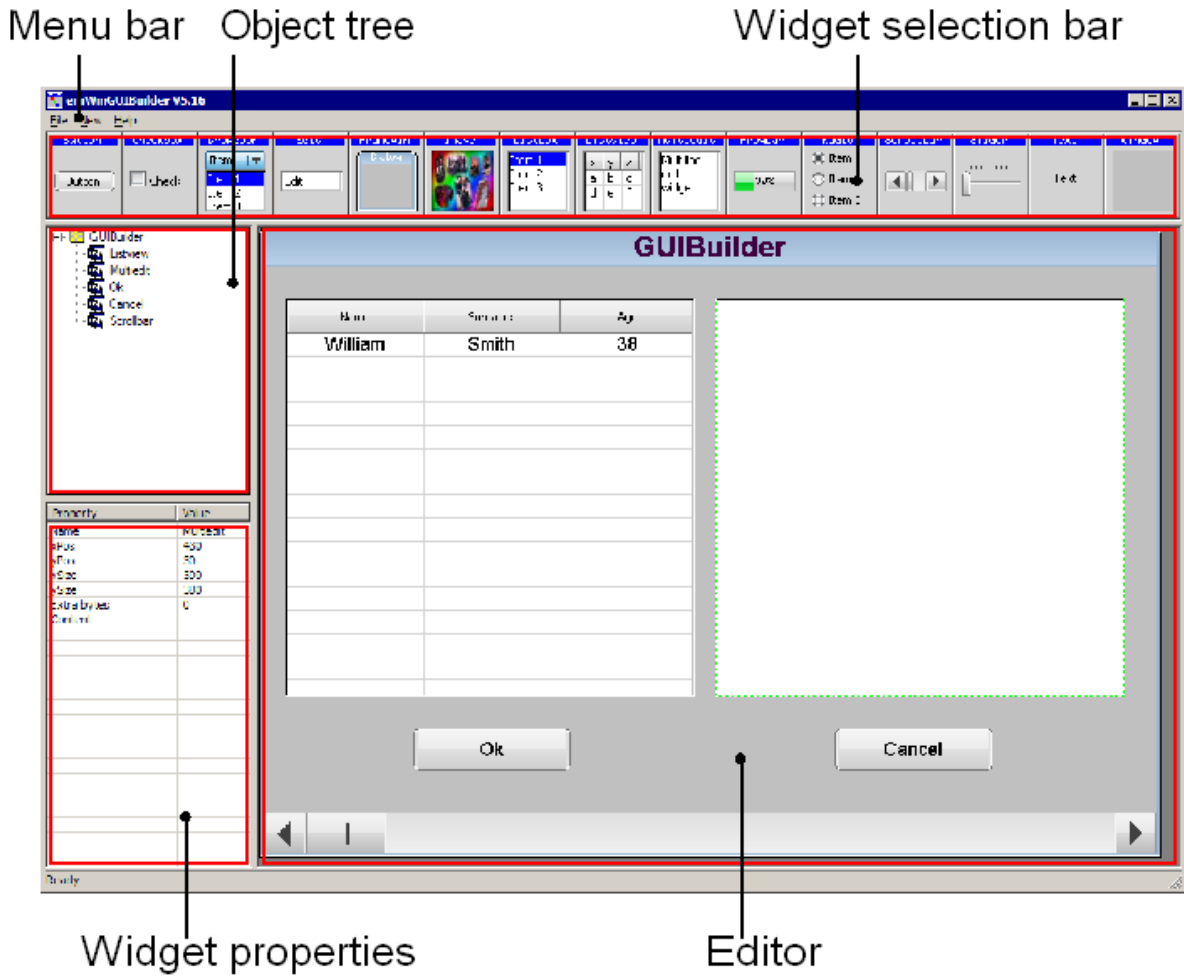

#### Widget selection bar

This bar contains all available widgets of the GUIBuilder. They can be added by a single click into the selection bar on the desired widget or by dragging them into the editor area.

#### Object tree

This area shows all currently loaded dialogs and their child widgets. It can be used for selecting a widget by clicking on the according entry.

#### Widget properties

It shows the properties of each widget and can be used for editing them.

#### Editor

The editor window shows the currently selected dialog. It can be used to place and resize the dialog and its widgets.



## 8.6.2 Getting started

Before starting a project, the GUIBuilder needs to know the project path. Per default this is the application path of the GUIBuilder. All files are saved in this folder.

### Setting up the project path

After the first execution, the GUIBuilder directory contains the configuration file GUIBuilder.ini. Within this file the project path can be changed by editing the value ProjectPath:



```
[Settings]
ProjectPath="C:
```

## 8.6.3 Creating a dialog

The following shows how to create a dialog and how to modify the properties of the used widgets.

### 8.6.3.1 Selecting a parent widget

Each dialog requires a valid parent widget. So it is required to start with a widget which is able to serve as a parent. Currently there are 2 widgets which can be used at this point:

| Frame window widget  | Window widget  |
|--|--|
|  |  |

The table above shows the according buttons of the widget selection bar. To get a widget into the editor the buttons can be single clicked, dragged with the mouse into the editor window or created by using the *New* menu.

### 8.6.3.2 Resizing and positioning in the editor

After placing a widget into the editor area it can be moved by using the mouse or the arrow keys of the keyboard. Resizing can be done by dragging the markers.

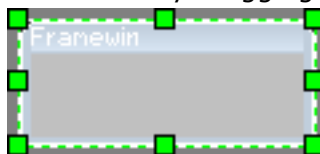

### 8.6.3.3 Modifying the widget properties

| Property    | Value    |
|-------------|----------|
| Name        | Framewin |
| xPos        | 0        |
| yPos        | 0        |
| xSize       | 320      |
| ySize       | 240      |
| Extra bytes | 0        |
|             |          |
|             |          |
|             |          |

The lower left area of the GUIBuilder contains the property window. After creating a new widget it shows the default properties of the widget: Name, position, size and extra bytes. These properties are available for all kinds of widgets and can not be removed. Contrary to the default properties all additional properties can be removed by the context menu or by pressing <DEL> when the according line is selected. To change a value it can be selected by the keyboard by pressing <ENTER> (if the desired line is selected and the window has the focus) or by single clicking into the value field. Further the 'Edit' entry of the context menu available with a right click can be used to start the edit operation. <ESC> can be used to abort the edit operation.

### 8.6.3.4 Adding additional functions to a widget

To get a context menu with the available functions for a widget either a right click in the editor window on the desired widget or a right click in the object tree can be done. Selecting a function adds a new property to the widget and starts the edit operation for the chosen function. In case of numerical or alpha numerical values the edit operation is done within the property window. In case of choosing fonts, text alignments or colors a separate selection window occurs.

#### Alignment selection

The alignment selection dialog shows the previous selected alignment in green. A single click within the box selects a new alignment. <ESC> aborts the selection.

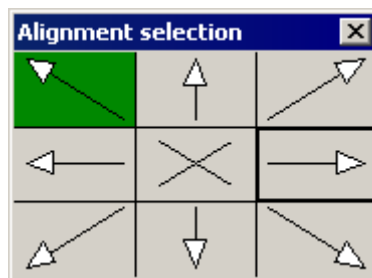

#### Color selection

For selecting a color the Windows default color selection dialog occurs. <ESC> aborts the selection.

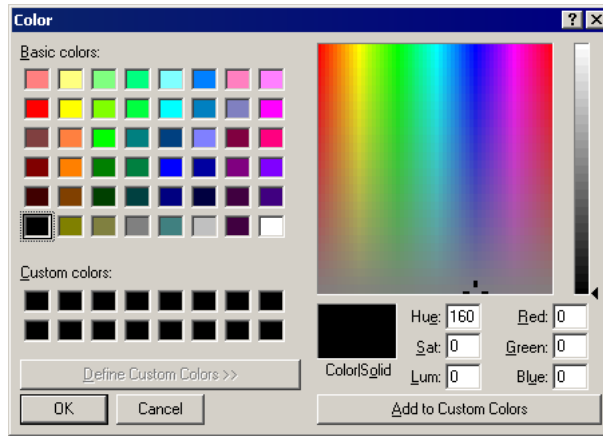

### Font selection

The font selection dialog shows all available fonts of the GUIBuilder. The desired font can be selected by a single click on the desired font. <ESC> aborts the selection.

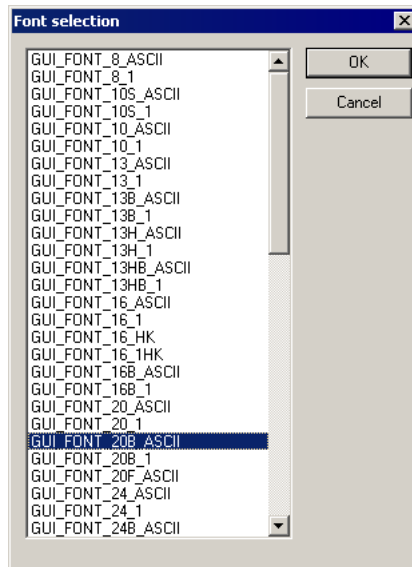

### 8.6.3.5 Deleting a widget property

This can be done easily by using the context menu of the property window or by pressing the <DEL> key if the desired property in the widget property window has the focus.

### 8.6.3.6 Deleting a widget

A widget can be deleted by pressing the <DEL> key if the widget is activated in the editor window. It can also be removed by selecting it in the object tree window and then pressing the <DEL> key. Deleting a widget automatically causes all of its child windows to be deleted as well.

### 8.6.3.7 Deleting a widget

A widget can be deleted by pressing the <DEL> key if the widget is activated in the editor window. It can also be removed by selecting it in the object tree window and then pressing the <DEL> key. Deleting a widget automatically causes all of its child windows to be deleted as well.

## 8.6.4 Saving the current dialog(s)

With the menu entry **File → Save...** all currently loaded dialogs will be saved in the project folder. Details on how to set up the project folder can be found in the section *Getting started* on page 2716.

Each dialog will be saved as a single C file. The file names are generated automatically by the name of the dialog root widget (FRAMEWIN or WINDOW widget). The file names are build as follows:

<Widget name>DLG.c If for example the name of the widget is *Framewin* the file will be named *FramewinDLG.c*.

## 8.6.5 Output of the GUIBuilder

As mentioned above the result of the GUIBuilder are C files only. The following shows a small sample which is generated by the tool:

```

/*****
 *
 *           SEGGER Microcontroller GmbH
 *     Solutions for real time microcontroller applications
 *
 *****/
 *
 *   C-file generated by:
 *
 *   GUI_Builder for emWin version 5.09
 *   Compiled Mar 23 2011, 09:52:04
 *   (c) 2011 Segger Microcontroller GmbH
 *
 *****/
 *
 *   Internet: www.segger.com Support: support@segger.com
 *
 *****/
 */
// USER START (Optionally insert additional includes)
// USER END
#include "DIALOG.h"
/*****
 *
 *   Defines
 *
 *****/
 */
#define ID_FRAMEWIN_0  (GUI_ID_USER + 0x0A)
#define ID_BUTTON_0    (GUI_ID_USER + 0x0B)
// USER START (Optionally insert additional defines)
// USER END
/*****
 *
 *   Static data
 *
 *****/
 */
// USER START (Optionally insert additional static data)
// USER END
/*****
 *
 *   _aDialogCreate
 */
static const GUI_WIDGET_CREATE_INFO _aDialogCreate[] = {
  { FRAMEWIN_CreateIndirect, "Framewin", ID_FRAMEWIN_0, 0, 0, 320, 240, 0, 0, 0 },
  { BUTTON_CreateIndirect, "Button", ID_BUTTON_0, 5, 5, 80, 20, 0, 0, 0 },
// USER START (Optionally insert additional widgets)
// USER END
};

```

```

/*****
 *
 *   Static code
 *
 *****/
// USER START (Optionally insert additional static code)
// USER END
/*****
 *
 *   _cbDialog
 */
static void _cbDialog(WM_MESSAGE * pMsg) {
    WM_HWIN hItem;
    int Id, NCode;
    // USER START (Optionally insert additional variables)
    // USER END
    switch (pMsg->MsgId) {
    case WM_INIT_DIALOG:
        //
        // Initialization of 'Framewin'
        //
        hItem = pMsg->hWin;
        FRAMEWIN_SetTextAlign(hItem, GUI_TA_HCENTER | GUI_TA_VCENTER);
        FRAMEWIN_SetFont(hItem, GUI_FONT_24_ASCII);
        //
        // Initialization of 'Button'
        //
        hItem = WM_GetDialogItem(pMsg->hWin, ID_BUTTON_0);
        BUTTON_SetText(hItem, "Press me...");
        // USER START (Opt. insert additional code for further widget initialization)
        // USER END
        break;
    case WM_NOTIFY_PARENT:
        Id = WM_GetId(pMsg->hWinSrc);
        NCode = pMsg->Data.v;
        switch(Id) {
        case ID_BUTTON_0: // Notifications sent by 'Button'
            switch(NCode) {
            case WM_NOTIFICATION_CLICKED:
                // USER START (Optionally insert code for reacting on notification message)
                // USER END
                break;
            case WM_NOTIFICATION_RELEASED:
                // USER START (Optionally insert code for reacting on notification message)
                // USER END
                break;
            // USER START (Opt. insert additional code for further notification handling)
            // USER END
            }
            break;
            // USER START (Optionally insert additional code for further IDs)
            // USER END
        }
        break;
        // USER START (Optionally insert additional message handling)
        // USER END
    default:
        WM_DefaultProc(pMsg);
        break;
    }
}
/*****
 *
 *   Public code
 *
 *****/
*/

```

```

/*****
 *
 *   CreateFramewin
 */
WM_HWIN CreateFramewin(void) {
    WM_HWIN hWin;
    hWin = GUI_CreateDialogBox(_aDialogCreate,
                               GUI_COUNTOF(_aDialogCreate), _cbDialog, WM_HBKWIN, 0, 0);
    return hWin;
}
// USER START (Optionally insert additional public code)
// USER END
/***** End of file *****/

```

## 8.6.6 Modifying the C files

As the sample code shows, it contains many sections for custom code. These are the following sections:

```

// USER START (Optionally insert ...)
// USER END

```

The start and end lines may not be modified. They are required for the GUIBuilder to be able to distinguish between user code and generated code. The following shows how it should work:

```

// USER START (Optionally insert additional includes)
#ifndef WIN32
    #include <ioat91sam9261.h>
#endif
// USER END

```

## 8.6.7 How to use the C files

As the sample output shows, the code does not contain any code which uses the dialogs or with other words makes them visible on the display. Each file contains a creation routine at the end named `Create<Widget name>()`. These routines create the according dialog. Simply call these routines to make them occur on the display.

### Example

The following code shows how to draw the dialog of the previous output sample on a display:

```

#include "DIALOG.h"
/*****
 *
 *   Externals
 *
 *****/
WM_HWIN CreateFramewin(void);
/*****
 *
 *   Public code
 *
 *****/
/*****
 *
 *   MainTask
 */
void MainTask(void) {
    WM_HWIN hDlg;
    GUI_Init();
}

```

```
//  
// Call creation function for the dialog  
//  
hDlg = CreateFrameWin();  
//  
// May do anything with hDlg  
//  
...  
//  
// Keep program alive...  
//  
while (1) {  
    GUI_Delay(10);  
}  
}
```

# Chapter 9

## Execution Model: Single Task / Multitask

---

emWin has been designed from the beginning to be compatible with different types of environments. It works in single task and in multitask applications, with a proprietary operating system or with any commercial RTOS such as embOS or uC/OS.



## 9.1 Supported execution models

We have to basically distinguish between 3 different execution models:

### **Single task system (super loop)**

The entire program runs in one super loop. Normally, all software components are periodically called. Interrupts must be used for real time parts of the software since no real time kernel is used.

### **Multitask system: one task calling emWin**

A real time kernel (RTOS) is used, but only one task calls emWin functions. From the graphic software's point of view, it is the same as being used in a single task system.

### **Multitask system: multiple tasks calling emWin**

A real time kernel (RTOS) is used, and multiple tasks call emWin functions. This works without a problem as long as the software is made thread-safe, which is done by enabling multitask support in the configuration and adapting the kernel interface routines. For popular kernels, the kernel interface routines are readily available.

## 9.2 Single task system (super loop)

### 9.2.1 Description

The entire program runs in one super loop. Normally, all components of the software are periodically called. No real time kernel is used, so interrupts must be used for real time parts of the software. This type of system is primarily used in smaller systems or if real time behavior is not critical.

### 9.2.2 Superloop example (without emWin)

```
void main (void) {
    HARDWARE_Init();
    /* Init software components */
    XXX_Init();
    YYY_Init();
    /* Superloop: call all software components regularly */
    while (1) {
        /* Exec all components of the software */
        XXX_Exec();
        YYY_Exec();
    }
}
```

### 9.2.3 Advantages

No real time kernel is used (→ smaller ROM size, just one stack → less RAM for stacks), no preemption/synchronization problems.

### 9.2.4 Disadvantages

The super loop type of program can become hard to maintain if it exceeds a certain program size. Real time behavior is poor, since one software component cannot be interrupted by any other component (only by interrupts). This means that the reaction time of one software component depends on the execution time of all other components in the system.

### 9.2.5 Using emWin

There are no real restrictions regarding the use of emWin. As always, `GUI_Init()` has to be called before you can use the software. From there on, any API function can be used. If the Window Manager's callback mechanism is used, then an emWin update function has to be called regularly. This is typically done by calling the `GUI_Exec()` from within the super loop. Blocking functions such as `GUI_ExecDialog()` should not be used in the loop since they would block the other software modules. The default configuration, which does not support multitasking (`#define GUI_OS 0`) can be used; kernel interface routines are not required.

### 9.2.6 Superloop example (with emWin)

```
void main (void) {
    HARDWARE_Init();
    /* Init software components */
    XXX_Init();
    YYY_Init();
    GUI_Init();           /* Init emWin */
    /* Superloop: call all software components regularly */
    while (1) {
        /* Exec all components of the software */
        XXX_Exec();
        YYY_Exec();
        GUI_Exec();       /* Exec emWin for functionality like updating windows */
    }
}
```

```
}  
}
```

## 9.3 Multitask system: one task calling emWin

### 9.3.1 Description

A real time kernel (RTOS) is used. The user program is split into different parts, which execute in different tasks and typically have different priorities. Normally the real time critical tasks (which require a certain reaction time) will have the highest priorities. **One single task** is used for the user interface, which calls emWin functions. This task usually has the lowest priority in the system or at least one of the lowest (some statistical tasks or simple idle processing may have even lower priorities).

Interrupts can, but do not have to be used for real time parts of the software.

### 9.3.2 Advantages

The real time behavior of the system is excellent. The real time behavior of a task is affected only by tasks running at higher priority. This means that changes to a program component running in a low priority task do not affect the real time behavior at all. If the user interface is executed from a low priority task, this means that changes to the user interface do not affect the real time behavior. This kind of system makes it easy to assign different components of the software to different members of the development team, which can work to a high degree independently from each other.

### 9.3.3 Using emWin

If the Window Manager's callback mechanism is used, then an emWin update function (typically `GUI_Exec()`, `GUI_Delay()`) has to be called regularly from the task calling emWin. Since emWin is only called by one task, to emWin it is the same as being used in a single task system.

The default configuration, which does not support multitasking (`#define GUI_OS 0`) can be used; kernel interface routines are not required. You can use any real time kernel, commercial or proprietary.

## 9.4 Multitask system: multiple tasks calling emWin

### 9.4.1 Description

A real time kernel (RTOS) is used. The user program is split into different parts, which execute in different tasks with typically different priorities. Normally the real time critical tasks (which require a certain reaction time) will have the highest priorities. **Multiple tasks** are used for the user interface, calling emWin functions. These tasks typically have low priorities in the system, so they do not affect the real time behavior of the system. Interrupts can, but do not have to be used for real time parts of the software.

### 9.4.2 Advantages

The real time behavior of the system is excellent. The real time behavior of a task is affected only by tasks running at higher priority. This means that changes of a program component running in a low priority task do not affect the real time behavior at all. If the user interface is executed from a low priority task, this means that changes on the user interface do not affect the real time behavior. This kind of system makes it easy to assign different components of the software to different members of the development team, which can work to a high degree independently from each other.

### 9.4.3 Using emWin

If the Window Manager's callback mechanism is used, then an emWin update function (typically `GUI_Exec()`, `GUI_Delay()`) has to be called regularly from one or more tasks calling emWin.

The default configuration, which does not support multitasking (`#define GUI_OS 0`) can **NOT** be used. The configuration needs to enable multitasking support and define a maximum number of tasks from which emWin is called (excerpt from `GUIConf.h`):

```
#define GUI_OS      1      // Enable multitasking support
#define GUI_MAXTASK 5      // Max. number of tasks that may call emWin
```

Kernel interface routines are required, and need to match the kernel being used. You can use any real time kernel, commercial or proprietary. Both the macros and the routines are discussed in the following chapter sections.

### 9.4.4 Recommendations

- Call the emWin update functions (that is, `GUI_Exec()`, `GUI_Delay()`) from just one task. It will help to keep the program structure clear. If you have sufficient RAM in your system, dedicate one task (with the lowest priority) to updating emWin. This task will continuously call `GUI_Exec()` as shown in the example below and will do nothing else.
- Keep your real time tasks (which determine the behavior of your system with respect to I/O, interface, network, etc.) separate from tasks that call emWin. This will help to assure best real time performance.
- If possible, use only one task for your user interface. This helps to keep the program structure simple and simplifies debugging. (However, this is not required and may not be suitable in some systems.)

### 9.4.5 Example

This excerpt shows the dedicated emWin update task. It is taken from the example `MT_Multitasking`, which is included in the examples shipped with emWin:

```
/* *****
 *
 *      GUI background processing
 *
 * This task does the background processing.
 * *****
```

```
* The main job is to update invalid windows, but other things such as
* evaluating mouse or touch input may also be done.
*/
void GUI_Task(void) {
    while(1) {
        GUI_Exec();           /* Do the background work ... Update windows etc.) */
        GUI_X_ExecIdle();    /* Nothing left to do for the moment ... Idle
        processing */
    }
}
```

## 9.5 Configuration functions for multitasking support

The following table shows the configuration functions available for a multitask system with multiple tasks calling emWin:

| Routine                                  | Description   |
|--|---|
| <code>GUI_SetSignalEventFunc()</code>    | Sets a function that signals an event.                                      |
| <code>GUI_SetWaitEventFunc()</code>      | Sets a function which waits for an event.                                   |
| <code>GUI_SetWaitEventTimedFunc()</code> | Defines a function which waits for an event for a dedicated period of time. |
| <code>GUI_WaitEvent()</code>             | Sets emWin into wait state.   |

## 9.5.1 GUI\_SetSignalEventFunc()

### Description

Sets a function that signals an event.

### Prototype

```
void GUI_SetSignalEventFunc(GUI_SIGNAL_EVENT_FUNC pfSignalEvent);
```

### Parameters

| Parameter                  | Description                                  |
|----------------------------|--|
| <code>pfSignalEvent</code> | Pointer to a function that signals an event. |

### Definition of GUI\_SIGNAL\_EVENT\_FUNC

```
typedef void (* GUI_SIGNAL_EVENT_FUNC)(void);
```

### Additional information

Per default the GUI needs to periodically check for events unless a function is defined which waits and one that triggers an event. This function sets the function which triggers an event. It makes only sense in combination with `GUI_SetWaitEventFunc()`, and `GUI_SetWaitEventTimedFunc()`. The advantage of using these functions instead of polling is the reduction of CPU load of the waiting task to 0% while it waits for input. If the function has been specified as recommended and the user gives the system any input (keyboard or pointer input device) the specified function should signal an event.

It is recommended to specify the function `GUI_X_SignalEvent()` for the job.

### Example

```
GUI_SetSignalEventFunc(GUI_X_SignalEvent);
```



## 9.5.2 GUI\_SetWaitEventFunc()

### Description

Sets a function which waits for an event.

### Prototype

```
void GUI_SetWaitEventFunc(GUI_WAIT_EVENT_FUNC pWaitEvent);
```

### Parameters

| Parameter               | Description                                    |
|-------------------------|--|
| <code>pWaitEvent</code> | Pointer to a function that waits for an event. |

### Definition of GUI\_SIGNAL\_EVENT\_FUNC

```
typedef void (* GUI_WAIT_EVENT_FUNC)(void);
```

### Additional information

Per default the GUI needs to periodically check for events unless a function is defined which waits and one that triggers an event. This function sets the function which waits for an event. Makes only sense in combination with `GUI_SetSignalEventFunc()` and `GUI_SetWaitEventTimedFunc()`. The advantage of using these functions instead of polling is the reduction of CPU load of the waiting task to 0% while it waits for input. If the function has been specified as recommended and the system waits for user input the defined function should wait for an event signaled from the function specified by `GUI_SetSignalEventFunc()`. It is recommended to specify the function `GUI_X_WaitEvent()` for the job.

### Example

```
GUI_SetWaitEventFunc(GUI_X_WaitEvent);
```

### 9.5.3 GUI\_SetWaitEventTimedFunc()

#### Description

Defines a function which waits for an event for a dedicated period of time.

#### Prototype

```
void GUI_SetWaitEventTimedFunc(GUI_WAIT_EVENT_TIMED_FUNC pfWaitEventTimed);
```

#### Parameters

| Parameter                     | Description                                    |
|-------------------------------|--|
| <code>pfWaitEventTimed</code> | Pointer to a function that waits for an event. |

#### Definition of GUI\_WAIT\_EVENT\_TIMED\_FUNC

```
typedef void (* GUI_WAIT_EVENT_TIMED_FUNC)(int Period);
```

| Parameter           | Description                        |
|---------------------|------------------------------------|
| <code>Period</code> | Period in ms to wait for an event. |

#### Additional information

Per default the GUI needs to periodically check for events unless a function is defined which waits and one that triggers an event. This function sets the function which waits for an event if a timer is active. Makes only sense in combination with `GUI_SetSignalEventFunc()` and `GUI_SetWaitEventFunc()`. If the function has been specified as recommended and the system waits for user input during a timer is active the defined function should wait until the timer expires or an event signaled from the function set by `GUI_SetSignalEventFunc()`. It is recommended to specify the function `GUI_X_WaitEventTimed()` for the job.

#### Example

```
GUI_SetWaitEventTimedFunc(GUI_X_WaitEventTimed);
```

## 9.5.4 GUI\_WaitEvent()

### Description

Sets emWin into wait state. If an event gets signaled emWin will continue.

### Prototype

```
void GUI_WaitEvent(void);
```

### Additional information

This function is called to let emWin wait for an event which gets signaled by the function set by `GUI_SetWaitEventFunc()`.

### Example

```
if (!GUI_Exec()) {  
    GUI_WaitEvent();  
}
```

## 9.6 Configuration macros for multitasking support

The following table shows the configuration macros used for a multitask system with multiple tasks calling emWin:

| Type | Macro                  | Default        | Description   |
|------|------------------------|----------------|---|
| N    | GUI_MAXTASK            | 4              | Defines the maximum number of tasks from which emWin is called when multi-tasking support is enabled. |
| B    | GUI_OS                 | 0              | Activate to enable multitasking support.  |
| F    | GUI_X_SIGNAL_EVENT     | -              | Defines a function that signals an event. (Obsolete)  |
| F    | GUI_X_WAIT_EVENT       | GUI_X_ExecIdle | Defines a function that waits for an event. (Obsolete)  |
| F    | GUI_X_WAIT_EVENT_TIMED | -              | Defines a function that waits for an event for a dedicated period of time. (Obsolete)                 |

### 9.6.1 GUI\_MAXTASK

#### Description

Defines the maximum number of tasks from which emWin is called to access the display.

#### Type

Numerical value.

#### Additional information

This symbol is only relevant when `GUI_OS` is activated. If working with a pre-compiled library the function `GUI_TASK_SetMaxTask()` should be used instead. Further information can be found in the function description of `GUI_TASK_SetMaxTask` on page 111.

### 9.6.2 GUI\_OS

#### Description

Enables multitasking support by activating the module `GUI_Task`.

#### Type

Binary switch

- 0: inactive, multitask support disabled (default)
- 1: active, multitask support enabled

### 9.6.3 GUI\_X\_SIGNAL\_EVENT

#### Description

Defines a function that signals an event.

#### Type

Function replacement

#### Additional information

Per default the GUI needs to periodically check for events unless a function is defined which waits and one that triggers an event. This macro defines the function which triggers an event. It makes only sense in combination with `GUI_X_WAIT_EVENT`. The advantage of using

the macros `GUI_X_SIGNAL_EVENT` and `GUI_X_WAIT_EVENT` instead of polling is the reduction of CPU load of the waiting task to 0% while it waits for input. If the macro has been defined as recommended and the user gives the system any input (keyboard or pointer input device) the defined function should signal an event.

It is recommended to specify the function `GUI_X_SignalEvent()` for the job.

### Example

```
#define GUI_X_SIGNAL_EVENT GUI_X_SignalEvent
```

## 9.6.4 GUI\_X\_WAIT\_EVENT

### Description

Defines a function which waits for an event.

### Type

Function replacement

### Additional information

Per default the GUI needs to periodically check for events unless a function is defined which waits and one that triggers an event. This macro defines the function which waits for an event. Makes only sense in combination with `GUI_X_SIGNAL_EVENT`. The advantage of using the macros `GUI_X_SIGNAL_EVENT` and `GUI_X_WAIT_EVENT` instead of polling is the reduction of CPU load of the waiting task to 0% while it waits for input. If the macro has been defined as recommended and the system waits for user input the defined function should wait for an event signaled from the function defined by the macro `GUI_X_SIGNAL_EVENT`.

It is recommended to specify the function `GUI_X_WaitEvent()` for the job.

### Example

```
#define GUI_X_WAIT_EVENT GUI_X_WaitEvent
```

## 9.6.5 GUI\_X\_WAIT\_EVENT\_TIMED

### Description

Defines a function which waits for an event for a dedicated period of time.

### Type

Function replacement

### Additional information

Per default the GUI needs to periodically check for events unless a function is defined which waits and one that triggers an event. This macro defines the function which waits for an event if a timer is active. Makes only sense in combination with `GUI_X_SIGNAL_EVENT`. If the macro has been defined as recommended and the system waits for user input during a timer is active the defined function should wait until the timer expires or an event signaled from the function defined by the macro `GUI_X_SIGNAL_EVENT`.

It is recommended to specify the function `GUI_X_WaitEventTimed()` for the job.

### Example

```
#define GUI_X_WAIT_EVENT_TIMED GUI_X_WaitEventTimed
```

## 9.7 Kernel interface API

An RTOS usually offers a mechanism called a resource semaphore, in which a task using a particular resource claims that resource before actually using it. The display is an example of a resource that needs to be protected with a resource semaphore. emWin uses the macro `GUI_USE` to call the function `GUI_Use()` before it accesses the display or before it uses a critical internal data structure. In a similar way, it calls `GUI_Unuse()` after accessing the display or using the data structure. This is done in the module `GUITask.c`.

`GUITask.c` in turn uses the GUI kernel interface routines shown in the table below. These routines are prefixed `GUI_X_` since they are high-level (hardware-dependent) functions. They must be adapted to the real time kernel used in order to make the emWin task (or thread) safe. Detailed descriptions of the routines follow, as well as examples of how they are adapted for different kernels.

| Routine                             | Description   |
|-------------------------------------|---|
| <code>GUI_X_GetTaskId()</code>      | Returns a unique ID for the current task.   |
| <code>GUI_X_InitOS()</code>         | Creates the resource semaphore or mutex typically used by <code>GUI_X_Lock()</code> and <code>GUI_X_Unlock()</code> . |
| <code>GUI_X_Lock()</code>           | Locks the GUI.  |
| <code>GUI_X_SignalEvent()</code>    | Signals an event.   |
| <code>GUI_X_Unlock()</code>         | Unlocks the GUI.  |
| <code>GUI_X_WaitEvent()</code>      | Waits for an event.   |
| <code>GUI_X_WaitEventTimed()</code> | Waits for an event for the given period.  |

## 9.7.1 GUI\_X\_GetTaskId()

### Description

Returns a unique ID for the current task.

### Prototype

```
U32 GUI_X_GetTaskId(void);
```

### Return value

ID of the current task as a 32-bit integer.

### Additional information

Used with a real-time operating system. It does not matter which value is returned, as long as it is unique for each task/ thread using the emWin API and as long as the value is always the same for each particular thread.

## 9.7.2 GUI\_X\_InitOS()

### Description

Creates the resource semaphore or mutex typically used by `GUI_X_Lock()` and `GUI_X_Unlock()`.

### Prototype

```
void GUI_X_InitOS(void);
```



### 9.7.3 GUI\_X\_Lock()

#### Description

Locks the GUI.

#### Prototype

```
void GUI_X_Lock(void);
```

#### Additional information

This routine is called by the GUI before it accesses the display or before using a critical internal data structure. It blocks other threads from entering the same critical section using a resource semaphore/mutex until `GUI_X_Unlock()` has been called. When using a real time operating system, you normally have to increment a counting resource semaphore.

## 9.7.4 GUI\_X\_SignalEvent()

### Description

Signals an event.

### Prototype

```
void GUI_X_SignalEvent(void);
```

### Additional information

This function is optional, it is used only via the macro `GUI_X_SIGNAL_EVENT` or the function `GUI_SetSignalEventFunc()`.

## 9.7.5 GUI\_X\_Unlock()

### Description

Unlocks the GUI.

### Prototype

```
void GUI_X_Unlock(void);
```

### Additional information

This routine is called by the GUI after accessing the display or after using a critical internal data structure. When using a real time operating system, you normally have to decrement a counting resource semaphore.

## 9.7.6 GUI\_X\_WaitEvent()

### Description

Waits for an event.

### Prototype

```
void GUI_X_WaitEvent(void);
```

### Additional information

This function is optional, it is used only via the macro `GUI_X_WAIT_EVENT` or the function `GUI_SetWaitEventFunc()`.

## 9.7.7 GUI\_X\_WaitEventTimed()

### Description

Waits for an event for the given period.

### Prototype

```
void GUI_X_WaitEventTimed(int Period);
```

### Parameters

| Parameter           | Description                           |
|---------------------|---------------------------------------|
| <code>Period</code> | <code>Period</code> in ms to be used. |

### Additional information

This function is optional, it is used only via the macro `GUI_X_WAIT_EVENT_TIMED` or the function `GUI_SetWaitEventTimedFunc()`.

## 9.8 Examples

### Kernel interface routines for embOS

The following example shows an adaption for embOS (excerpt from file GUI\_X\_embOS.c located in the folder Sample\GUI\_X):

```
#include "RTOS.H"
static OS_TASK* _pGUITask;
static OS_RSEMA _RSEma;
void GUI_X_InitOS(void) { OS_CreateRSEma(&_RSEma); }
void GUI_X_Unlock(void) { OS_Unuse(&_RSEma); }
void GUI_X_Lock(void) { OS_Use(&_RSEma); }
U32 GUI_X_GetTaskId(void) { return (U32)OS_GetTaskID(); }
void GUI_X_WaitEvent(void) {
    _pGUITask = OS_GetpCurrentTask();
    OS_WaitEvent(1);
}
void GUI_X_SignalEvent(void) {
    if (_pGUITask) {
        OS_SignalEvent(1, _pGUITask);
    }
}
void GUI_X_WaitEventTimed(int Period) {
    static OS_TIMER Timer;
    static int Initialized;

    if (Period > 0) {
        if (Initialized != 0) {
            OS_DeleteTimer(&Timer);
        }
        Initialized = 1;
        OS_CreateTimer(&Timer, GUI_X_SignalEvent, Period);
        OS_StartTimer(&Timer);
        GUI_X_WaitEvent();
    }
}
```

### Kernel interface routines for uC/OS

The following example shows an adaption for uC/OS (excerpt from file GUI\_X\_uCOS.c located in the folder Sample\GUI\_X):

```
#include "INCLUDES.H"
static OS_EVENT * pDispSem;
static OS_EVENT * pGUITask;
U32 GUI_X_GetTaskId(void) { return ((U32)(OSTCBCur->OSTCBPrio)); }
void GUI_X_Unlock(void) { OSSemPost(pDispSem); }
void GUI_X_InitOS(void) {
    pDispSem = OSSemCreate(1);
    pGUITask = OSSemCreate(0);
}
void GUI_X_Lock(void) {
    INT8U err;
    OSSemPend(pDispSem, 0, &err);
}
```

### Kernel interface routines for Win32

The following is an excerpt from the Win32 simulation for emWin. When using the emWin simulation, there is no need to add these routines, as they are already in the library.

**Note**

Cleanup code has been omitted for clarity.

```
/*
 *
 *      emWin - Multitask interface for Win32
 *
 *
 *      The following section consisting of 4 routines is used to make
 *      emWin thread safe with WIN32
 */
static HANDLE hMutex;
void GUI_X_InitOS(void) {
    hMutex = CreateMutex(NULL, 0, "emWinSim - Mutex");
}
unsigned int GUI_X_GetTaskId(void) {
    return GetCurrentThreadId();
}
void GUI_X_Lock(void) {
    WaitForSingleObject(hMutex, INFINITE);
}
void GUI_X_Unlock(void) {
    ReleaseMutex(hMutex);
}
```

# Chapter 10

## MultiLayer / MultiDisplay support

---

Multiple displays and multiple layers can be utilized via emWin MultiLayer support. If the hardware supports multiple layers, MultiLayer support can be used. If the hardware does not include such a function, multiple layers can be implemented using the emWin SoftLayer feature.

MultiLayer and MultiDisplay support work the same way. Each layer / display can be accessed with its own color settings, its own size and its own display driver. Initialization of more than one layer is quite simple: The maximum number of available layers `GUI_NUM_LAYERS` should be defined in `GUIConf.h` and each layer needs a display driver device which should be created during the initialization in the configuration routine `LCD_X_Config()`. There is no limitation regarding the maximum number of available layers.

All SoftLayers use an internal driver which works with 32bpp. The SoftLayer composite is converted to the color setting of the display. SoftLayers and MultiLayer support can not be used in combination. Therefore SoftLayers have to be configured slightly different from MultiLayers.



## 10.1 Introduction

This chapter deals with multiple hardware layers (MultiLayer), multiple software layers (SoftLayer) and multiple displays (MultiDisplay). Since a lot of information is valid for each of those features, the following sections will just refer to it as layers unless there are functional differences.

Windows and drawing operations can be placed and performed on any layer. emWinView can output every single layer and the composite view in a separate window.

### 10.1.1 Selecting a layer for drawing operations

When drawing directly, per default layer 0 is used. Other layers can be selected by using the function `GUI_SelectLayer()`.

#### Example

The following example shows how to select a layer for drawing operations:

```
void MainTask(void) {
    GUI_Init();
    //
    // Draw something on default layer 0
    //
    GUI_SetBkColor(GUI_GREEN);
    GUI_Clear();
    GUI_DispStringHCenterAt("Layer 0", 100, 46);
    //
    // Draw something on layer 1
    //
    GUI_SelectLayer(1);
    GUI_SetBkColor(GUI_RED);
    GUI_Clear();
    GUI_SetColor(GUI_BLUE);
    GUI_FillRect(20, 20, 179, 79);
    GUI_SetColor(GUI_WHITE);
    GUI_SetTextMode(GUI_TM_TRANS);
    GUI_DispStringHCenterAt("Layer 1", 100, 46);
    while(1) {
        GUI_Delay(100);
    }
}
```

#### Screenshot of the above example

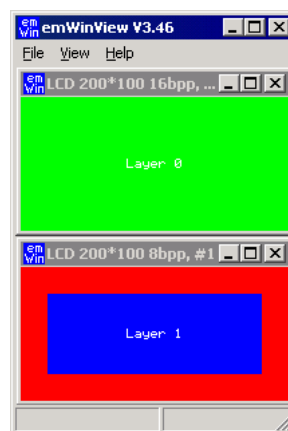

### 10.1.2 Selecting a layer for a window

The Window Manager automatically keeps track of which window is located in which layer. This is done in a fairly easy way: If the Window Manager is used, every layer has a top

level (desktop) window. Any other window in this layer is visible only if it is a descendant of the according desktop window. Windows are connected to a certain layer depending on if they are a descendant of the layer's desktop window.

### Example

The following example shows how to create 3 windows on 2 different desktop windows:

```
//
// Create 1 child window on desktop 0
//
hWin0 = WM_CreateWindowAsChild( 10, 20, 80, 70,
    WM_GetDesktopWindowEx(0), WM_CF_SHOW, _cbWin0, 0);
//
// Create 2 child windows on desktop 1
//
hWin1 = WM_CreateWindowAsChild( 10, 20, 80, 70,
    WM_GetDesktopWindowEx(1), WM_CF_SHOW, _cbWin1, 0);
hWin2 = WM_CreateWindowAsChild(110, 20, 80, 70,
    WM_GetDesktopWindowEx(1), WM_CF_SHOW, _cbWin2, 0);
```

The following table shows the screenshot and the window hierarchy of the above example:

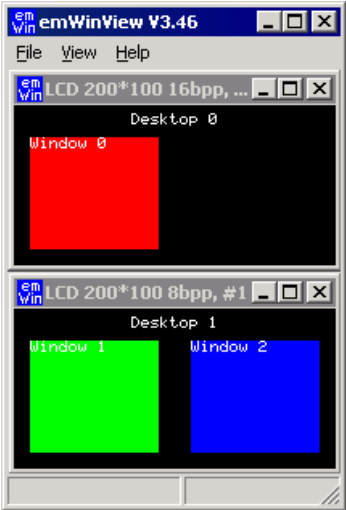
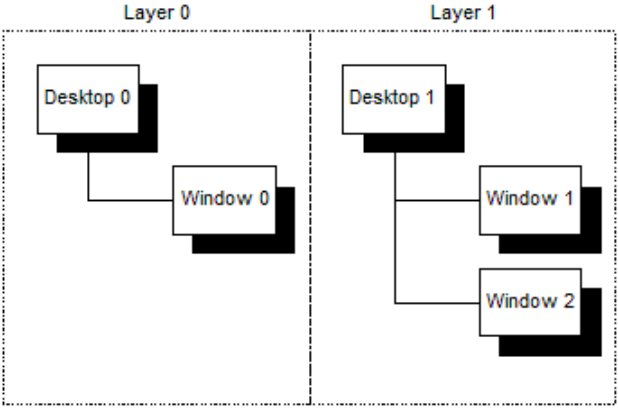
| Screenshot   | Window hierarchy  |
|--|---|
|  |  |

#### 10.1.2.1 Moving a window from one layer to another

This can sometime be very desirable and can easily be accomplished: If a window is detached from its parent (The desktop window of one layer or any descendant of this desktop window) and attached to a window which lies in another layer, this window actually moves from one layer to another layer.

### Example

The following example shows how to attach a window to a new parent window:

```
//
// Create 1 child window on desktop 0
//
hWin0 = WM_CreateWindowAsChild( 10, 20, 80, 70,
    WM_GetDesktopWindowEx(0), WM_CF_SHOW, _cbWin0, 0);
//
// Create 2 child windows on desktop 1
//
hWin1 = WM_CreateWindowAsChild( 10, 20, 80, 70,
    WM_GetDesktopWindowEx(1), WM_CF_SHOW, _cbWin1, 0);
hWin2 = WM_CreateWindowAsChild(110, 20, 80, 70,
```

```
WM_GetDesktopWindowEx(1), WM_CF_SHOW, _cbWin2, 0);  
GUI_Delay(1000);  
//  
// Detach window 2 from desktop 1 and attach it to desktop 0  
//  
WM_AttachWindow(hWin2, WM_GetDesktopWindowEx(0));
```

The following table shows the screenshot and the window hierarchy of the above example before attaching the window to the new parent:

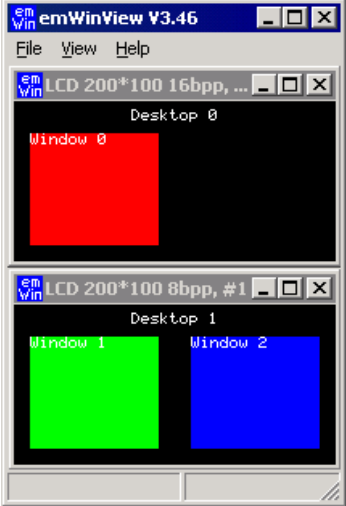
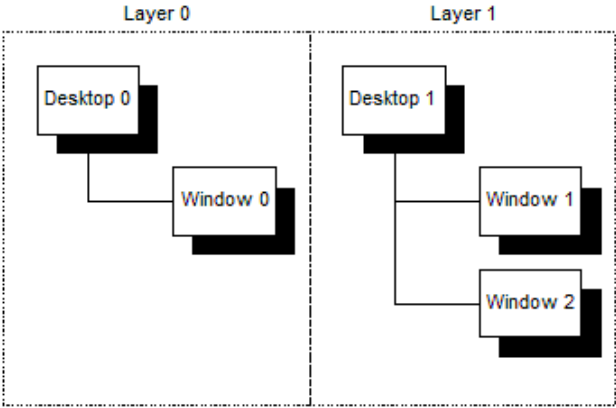
| Screenshot   | Window hierarchy   |
|--|--|
|  |  |

The next table shows the screenshot and the window hierarchy of the above example after attaching the window to the new parent:

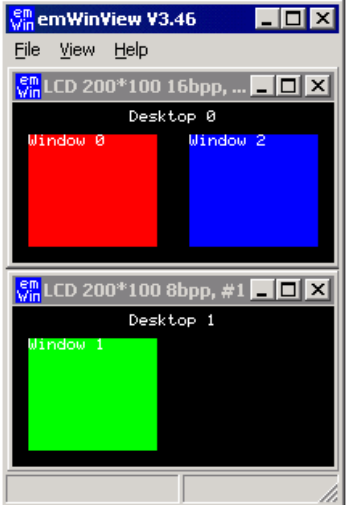
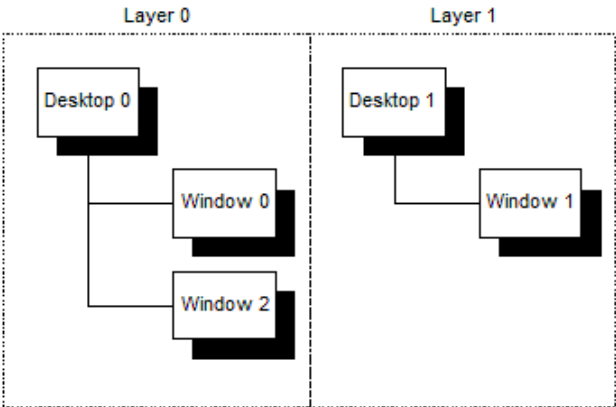
| Screenshot  | Window hierarchy   |
|---|--|
|  |  |

## 10.2 Using MultiLayer support

emWin does not distinguish between multiple layers or multiple displays. When using multiple layers normally the size and the driver for each layer is the same. The viewer shows each layer in a separate window. The composite window of the viewer shows all layers; layers with higher index are on top of layers with lower index and can have transparent pixels:

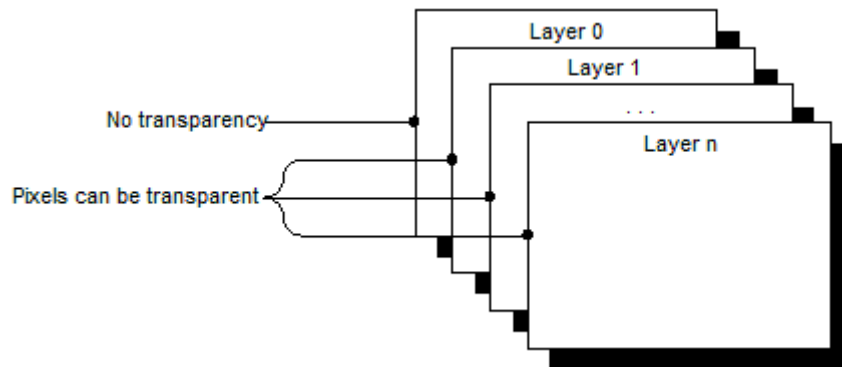

### 10.2.1 Transparency

Transparency means that at the position of pixels with color index 0 in a layer  $> 0$ , the color of the background layer is visible. Since for all but layer 0 Index 0 means transparency, Index 0 can not be used to display colors. This also means that the color conversion should never yield 0 as best match for a color, since this would result in a transparent pixel. This means that only some fixed palette modes or a custom palette mode should be used and that you need to be careful when defining your own palette. You need to make sure that the color conversion (24 bit RGB  $\rightarrow$  Index) never yields 0 as result.

#### Fixed palette modes

The only available fixed palette modes including transparency (not Alpha Blending) are GUICC\_M1555I and GUICC\_8666\_1. Details about fixed palette modes can be found in the chapter *Colors* on page 478.

#### Custom palette mode

If a custom palette should be used in a layer  $> 0$ , the first color should not be used from the color conversion routines. The following shows an example definition for a custom palette with 15 gray scales:

```
static const LCD_COLOR _aColors_16[] = {
    GUI_TRANSPARENT, 0x000000, 0x222222, 0x333333,
    0x444444, 0x555555, 0x666666, 0x777777,
    0x888888, 0x999999, 0xAAAAAA, 0BBBBBB,
    0xCCCCCC, 0xDDDDDD, 0xEEEEEE, 0xFFFFF
};
static const LCD_PHYSPALETTE _aPalette_16 = {
    16, _aColors_16
};
void LCD_X_Config(void) {
    //
    // Set display driver and color conversion for 1st layer
    //
    .
    .
    .
    //
    // Set user palette data (only required if no fixed palette is used)
    //
    LCD_SetLUTEx(1, _aPalette_16);
}
```

The description of the function `LCD_SetLUTEx()` can be found under *Custom palette mode* on page 502.

### Example

The following example shows how to use transparency. It draws 3 color bars in layer 0. Layer 1 is filled with white and 3 transparent items are drawn.

```
GUI_SelectLayer(0);
GUI_SetColor(GUI_RED);
GUI_FillRect(0, 0, 199, 33);
GUI_SetColor(GUI_GREEN);
GUI_FillRect(0, 34, 199, 66);
GUI_SetColor(GUI_BLUE);
GUI_FillRect(0, 67, 199, 99);
GUI_SelectLayer(1);
GUI_SetBkColor(GUI_WHITE);
GUI_Clear();
GUI_SetColor(GUI_BLACK);
GUI_DispStringHCenterAt("Layer 1", 100, 4);
GUI_SetColor(GUI_TRANSPARENT);
GUI_FillCircle(100, 50, 35);
GUI_FillRect(10, 10, 40, 90);
GUI_FillRect(160, 10, 190, 90);
```

### Screenshots of above example

The table below shows the contents of the separate layers and the composite view, as the result appears on the display:

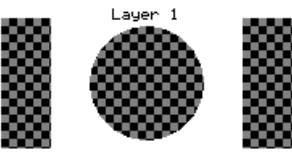
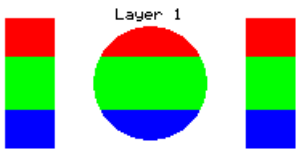
| Layer 0   | Layer 1   | Display   |
|---|---|---|
|  |  |  |

## 10.2.2 Alpha blending

Alpha blending is a method of combining two colors for transparency effects. Assumed 2 colors  $C_0$  and  $C_1$  should be combined with alpha blending  $A$  (a value between 0 and 1 where 0 means invisible and 1 means 100% visible) the resulting color  $C_r$  can be calculated as follows:

$$C_r = C_0 * (1 - A) + C_1 * A$$

Logical colors are handled internally as 32 bit values. The lower 24 bits are used for the color information and the alpha blending is managed in the upper 8 bits. An alpha value of  $0x00$  means opaque and  $0xFF$  means completely transparent (invisible).

### Different methods

There are 3 different methods of managing the alpha information:

- **Layer alpha blending:** On systems with layer alpha blending the alpha value is fixed to the layer and can be set with the function `LCD_SetAlphaEx()`.
- **Lookup table (LUT) alpha blending:** This kind of alpha blending uses the LUT for managing the alpha information.
- **Pixel alpha blending:** Each pixel of the layer which has to be combined with the background consists of alpha blending information.

## Fixed palette modes

For LUT alpha blending the fixed palette modes 822216 and 84444 can be used. Pixel alpha blending is supported only in 32 bpp mode using the fixed palette mode 8888. For details about the fixed palette modes, refer to the chapter *Colors* on page 478.



## Example

The following example shows how to use pixel alpha blending. It draws a circle in layer 0 and a yellow triangle build of horizontal lines with a vertical gradient of alpha values:

```
GUI_SetColor(GUI_BLUE);
GUI_FillCircle(100, 50, 49);
GUI_SelectLayer(1);
GUI_SetBkColor(GUI_TRANSPARENT);
GUI_Clear();
for (i = 0; i < 100; i++) {
    U32 Alpha;
    Alpha = (i * 255 / 100) << 24;
    GUI_SetColor(GUI_YELLOW | Alpha);
    GUI_DrawHLine(i, 100 - i, 100 + i);
}
```

## Screenshots of above example

The table below shows the contents of the separate layers and the composite view, as the result appears on the display:

| Layer 0   | Layer 1   | Display   |
|---|---|---|
|  |  |  |

## 10.2.3 Hardware cursors

The term “Hardware cursor” means the use of cursor images in a separate layer with a transparent background. If a hardware supports multiple layers and the ability of layer positioning emWin can be configured to use a separate layer for managing the cursor. The main advantages of this kind of cursor support are a better performance because only a few registers need to be changed on a movement and the ability of custom drawings in the cursor layer. For details about usage, refer to *GUI\_AssignCursorLayer* on page 2914.

## 10.2.4 MultiLayer example

For information about a multi-layer example, see the chapter *Simulation* on page 166. Further, the `Sample` folder contains the following example which shows how to use multiple layer support:

- `MULTILAYER_AlphaChromaMove.c`

## Screenshot of above example

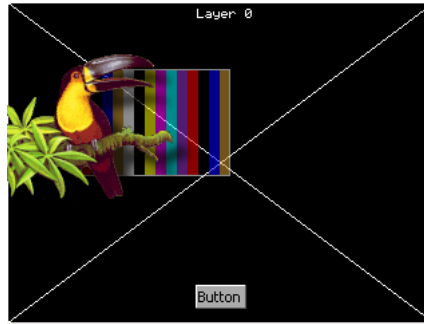

## 10.2.5 Configuring MultiLayer support

### LCD Configuration of the above MultiLayer example

```

void LCD_X_Config(void) {
    //
    // Set display driver and color conversion for first layer ...
    //
    GUI_DEVICE_CreateAndLink(GUIDRV_LIN_16, // Display driver
                             GUICC_655,    // Color conversion
                             0, 0);

    //
    // ... and configure it
    //
    LCD_SetSizeEx (0, 400, 234);           // Physical display size in pixels
    LCD_SetVRAMAddrEx(0, (void *)0xc00000); // Video RAM start address
    //
    // Set display driver and color conversion for second layer ...
    //
    GUI_DEVICE_CreateAndLink(GUIDRV_LIN_8, // Display driver
                             GUICC_86661, // Color conversion
                             0, 1);

    //
    // ... and configure it
    //
    LCD_SetSizeEx(1, 400, 234);           // Physical display size in pixels
    LCD_SetVRAMAddrEx(1, (void *)0xc00000); // Video RAM start address
}

```

## 10.3 Using MultiDisplay support

Each display can be accessed with its own driver and with its own settings.

### 10.3.1 Enabling MultiDisplay support

To enable the MultiDisplay support you have to define the maximum number of layers in `GUIConf.h`:

```
#define GUI_NUM_LAYERS 2 /* Enables support for 2 displays/layers */
```

Further you have to create and configure a display driver device for each layer.

### 10.3.2 Run-time screen rotation

In some cases it may be necessary to change the display orientation at run-time. The MultiDisplay support allows to do this. In this case the file `LCDConf.c` should contain a display configuration for each required display orientation. Switching the display orientation then works as follows:

- Select the configuration with the required display orientation with `GUI_SelectLayer()`.
- If the rotation requires a reinitialization of the display controller the right driver function for reinitializing should be called. This is `LCD_L0_Init()` for layer 0 and `LCD_L0_x_Init()` for higher layers, where "x" means the zero based index of the configuration.

### 10.3.3 MultiDisplay example

The example below shows a screenshot of the simulation with 2 displays. The first display is a 8bpp color display with a size of 320 \* 240 pixels. The driver is `GUIDRV_Lin_8`. The second display is a 1bpp black and white display with a size of 240 \* 128 pixels. The driver is `GUIDRV_SLin_1.c`:

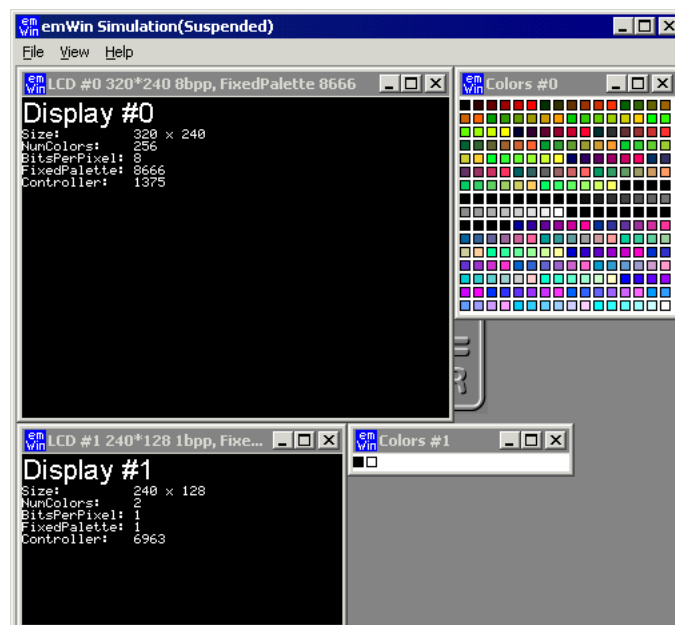



## 10.3.4 Configuring MultiDisplay support

### Configuration of the above example

```
void LCD_X_Config(void) {
    //
    // Set display driver and color conversion for first layer ...
    //
    GUI_DEVICE_CreateAndLink(GUIDRV_LIN_8, // Display driver
                             GUICC_8666, // Color conversion
                             0, 0);

    //
    // ... and configure it
    //
    LCD_SetSizeEx(0, 320, 240); // Physical display size in pixels
    LCD_SetVRAMAddrEx(0, (void *)0xc00000); // Video RAM start address
    //
    // Set display driver and color conversion for second layer ...
    //
    GUI_DEVICE_CreateAndLink(GUIDRV_SLIN_1, // Display driver
                             GUICC_1, // Color conversion
                             0, 1);

    //
    // ... and configure it
    //
    LCD_SetSizeEx(1, 240, 128); // Physical display size in pixels
}
```

## 10.4 Using SoftLayers

In case multiple hardware layers are not supported, emWin offers the possibility to make use of software layers. The advantage of softlayers is they can be used on any target hardware meeting the memory requirements. The disadvantage is additional CPU load to render the layers. Rendering is done automatically by executing the GUI. Alternatively the function `GUI_SOFTLAYER_Refresh()` can be called to immediately refresh the layers.

emWin SoftLayers are highly optimized. Layers are refreshed only if there is at least one dirty area. Drawing operations are tracked automatically to create/extend according dirty areas. A refresh is processed by dividing dirty areas in sub-rectangles which affect the same layers for faster color calculation. This way processing all layers unnecessarily for all pixels is avoided.

If there are dirty areas, pixel data is processed from the bottom to the top starting with the top opaque layer. Layers below the top opaque layer would not have any impact on the result.

### Mixing example (opaque and non-overlapping layers)

Assuming there is a configuration including 4 SoftLayers. Drawing operations have been done, so a dirty area exists. Layer 1 is opaque, layer 2 does not overlap the dirty area and layer 3 contains semi-transparent pixels. In this case the SoftLayer logic would ignore layer 0 and layer 2, so the only thing to do would be mixing the colors from layer 1 and 3.

### Mixing example (composite color and several semi-transparent layers)

Assuming there is a configuration including 4 SoftLayers in which the layers contain either transparency, semi-transparency or are not affected by the dirty area at all, the composite color is used as "opaque layer". In this case the composite color is mixed with the content of layer 0. The result would be mixed with the content of layer 1. In turn the result would be mixed with the content of layer 2. And so on...

### 10.4.1 Using SoftLayers within a simulation environment

In a simulation environment SoftLayers have to be set up differently from HardLayers. Below information should be a help for configuring the simulation properly for the use of SoftLayers. The according function descriptions can be found in the chapter *Simulation* on page 166.

#### Composite color

SoftLayers consist of their own composite color which can be set using the function `GUI_SOFTLAYER_Enable()` or `GUI_SOFTLAYER_SetCompositeColor()`. The function `GUI_SIM_SetCompositeColor()` does not have an effect with SoftLayers.

#### Composite size

The function `SIM_GUI_SetCompositeSize()` can be used for setting the size of the composite view. Calling this function is required for SoftLayer use.

#### Transparency mode

In order to benefit from transparency effects, Layers can be configured for a certain transparency mode using the function `SIM_GUI_SetTransMode()`. Transparency can be implemented either via "zero transparency" or via "pixel alpha".

#### SIMConf.c example

```
void SIM_X_Config() {
    SIM_GUI_SetCompositeSize(480, 272); // Set size of composite window
    SIM_GUI_SetTransMode(1, GUI_TRANSMODE_PIXELALPHA);
    SIM_GUI_SetTransMode(2, GUI_TRANSMODE_PIXELALPHA);
    SIM_GUI_SetTransMode(3, GUI_TRANSMODE_PIXELALPHA);
}
```

## 10.4.2 Memory requirements

emWin SoftLayers require storing additional information in RAM which can be subdivided in display related memory and layer related memory. The memory is taken from the memory pool which is assigned to emWin using `GUI_ALLOC_AssignMemory()` in function `GUI_X_Config()` (`GUIConf.c`).

### Required display related memory

Depending on the display size and color depth, SoftLayers require storing data for the following items:

- SoftLayer driver context.
- 32bpp buffer with the size of the display width.
- Frame buffer with the size and color depth of the display.

The required display related memory can be calculated using the following formula:

```
ReqMem = 68 Bytes + xSizeDisp * 4 + xSizeDisp * ySizeDisp * BytesPerPixelDisp
```

### Required layer related memory

Depending on the SoftLayer configuration, SoftLayers require additional memory to store one complete frame for each layer at a color depth of 32bpp.

The required display related memory can be calculated using the following formula:

```
ReqMem += xSize0 * ySize0 * 4 + xSize1 * ySize1 * 4 + ... (and so on)
```

### Explanation of terms

| Term              | Explanation   |
|-------------------|---|
| 68 Bytes          | Required for context information in the SoftLayer driver. |
| xSizeDisp         | X-size of the display.                                    |
| ySizeDisp         | Y-size of the display.                                    |
| BytesPerPixelDisp | Number of bytes per pixel used by the display.            |
| xSize0            | X-size of layer 0.  |
| ySize0            | Y-size of layer 0.  |

## 10.4.3 Configuring SoftLayers

SoftLayers need to be configured different from hardware layers. In order to set up the desired layers a data structure of type `GUI_SOFTLAYER_CONFIG` needs to be filled and passed to the function `GUI_SOFTLAYER_Enable()`. SoftLayers do not require each layer to have a separate driver device. There is an internal SoftLayer driver which is automatically used for all layers.

### LCDConf.c

```
void LCD_X_Config(void) {
    GUI_SOFTLAYER_CONFIG aConfig[] = {
        { 0, 0, 480, 272, 1 },
        { 0, 0, 120, 108, 1 },
        { 0, 0, 120, 74, 1 },
        { 30, 30, 420, 35, 1 },
    };
    //
    // Set display driver and color conversion for 1st layer
    //
    GUI_DEVICE_CreateAndLink(DISPLAY_DRIVER, COLOR_CONVERSION, 0, 0);
    //
    // Display driver configuration
}
```

```
//  
LCD_SetSizeEx    (0, XSIZE_PHYS,  YSIZE_PHYS);  
LCD_SetVSizeEx  (0, VXSIZE_PHYS,  VYSIZE_PHYS);  
LCD_SetVRAMAddrEx(0, (void *)VRAM_ADDR);  
//  
// SoftLayer activation after existing single layer configuration  
//  
GUI_SOFTLAYER_Enable(aConfig, GUI_COUNTOF(aConfig), GUI_DARKBLUE);  
}
```

## 10.5 MultiLayer API

The table below lists the available MultiLayer related routines in alphabetical order. Detailed descriptions follow:

### Functions

| Routine  | Description  |
|--|--|
| General MultiLayer functions                   |  |
| <code>GUI_AssignCursorLayer()</code>           | The function assigns a layer to be used as cursor layer.         |
| <code>GUI_GetLayerPosEx()</code>               | Returns the X- and Y-position of the given layer.                |
| <code>GUI_SelectLayer()</code>                 | Selects a layer for drawing operations.                          |
| <code>GUI_SetLayerAlphaEx()</code>             | Sets the alpha blending of the given layer.                      |
| <code>GUI_SetLayerPosEx()</code>               | Sets the X- and Y-position of the given layer.                   |
| <code>GUI_SetLayerSizeEx()</code>              | Sets the X- and Y-size of the given layer.                       |
| <code>GUI_SetLayerVisEx()</code>               | Sets the visibility of the given layer.                          |
| <code>LCD_GetNumLayers()</code>                | Returns the number of layers configured in your configuration.   |
| SoftLayer specific functions                   |  |
| <code>GUI_SOFTLAYER_Enable()</code>            | Enables and configures SoftLayers.                               |
| <code>GUI_SOFTLAYER_Refresh()</code>           | Refreshes layers by rerendering the dirty area.                  |
| <code>GUI_SOFTLAYER_SetCompositeColor()</code> | Sets the composite color.  |
| <code>GUI_SOFTLAYER_MULTIBUF_Enable()</code>   | Enables the automatic use of Multiple Buffering with SoftLayers. |

### Data structures

| Structure                         | Description   |
|-----------------------------------|---|
| <code>GUI_SOFTLAYER_CONFIG</code> | Data structure used by <code>GUI_SOFTLAYER_Enable()</code> to configure a soft layer. |

## 10.5.1 General MultiLayer functions

### 10.5.1.1 GUI\_AssignCursorLayer()

#### Description

The function assigns a layer to be used as cursor layer.

#### Prototype

```
void GUI_AssignCursorLayer(unsigned LayerIndex,  
                           unsigned CursorLayer);
```

#### Parameters

| Parameter                   | Description                            |
|-----------------------------|--|
| <a href="#">Index</a>       | Layer index.                           |
| <a href="#">CursorLayer</a> | Layer to be used to manage the cursor. |

#### Additional information

Using a hardware cursor means a layer is used as cursor layer. Contrary to the default cursor handling, where the cursor is drawn in the same video memory area as all other items, a hardware cursor is drawn in a separate layer. In this case emWin makes sure the background color of the hardware cursor layer is set to transparency and the selected cursor will be drawn into the layer. Whereas the default cursor management requires more or less calculation time to draw the cursor and to manage the background, moving a hardware cursor requires only the modification of a few registers. Note that using this function requires that the display driver supports layer positioning.

### 10.5.1.2 GUI\_GetLayerPosEx()

#### Description

Returns the X- and Y-position of the given layer.

#### Prototype

```
int GUI_GetLayerPosEx(unsigned LayerIndex,  
                     int * pxPos,  
                     int * pyPos);
```

#### Parameters

| Parameter             | Description   |
|-----------------------|---|
| <a href="#">Index</a> | Layer index.  |
| <a href="#">pxPos</a> | Pointer to an integer to be used to return the X position of the given layer. |
| <a href="#">pyPos</a> | Pointer to an integer to be used to return the Y position of the given layer. |

#### Additional information

To be able to use this function the hardware and the used display driver need to support layer positioning. If the driver does not support this feature the function returns immediately.

### 10.5.1.3 GUI\_SelectLayer()

#### Description

Selects a layer for drawing operations.

#### Prototype

```
unsigned GUI_SelectLayer(unsigned Index);
```

#### Parameters

| Parameter             | Description  |
|-----------------------|--------------|
| <a href="#">Index</a> | Layer index. |

#### Return value

[Index](#) of the previously selected layer.



### 10.5.1.4 GUI\_SetLayerAlphaEx()

#### Description

Sets the alpha blending of the given layer.

#### Prototype

```
int GUI_SetLayerAlphaEx(unsigned LayerIndex,  
                        int Alpha);
```

#### Parameters

| Parameter             | Description  |
|-----------------------|--|
| <a href="#">Index</a> | Layer index.   |
| <a href="#">Alpha</a> | <a href="#">Alpha</a> blending value of the given layer. |

#### Return value

0        on success  
1        on error.

#### Additional information

To be able to use this function the hardware and the used display driver need to support layer alpha blending. If the driver does not support this feature the function returns immediately. The usable range of alpha values depends on the hardware. In many cases the range of alpha values is limited, for example 0 - 0x3f. emWin does not know something about limitations and passes the given value to the driver. It is the responsibility of the application to make sure that the given value is in a legal range.

### 10.5.1.5 GUI\_SetLayerPosEx()

#### Description

Sets the X- and Y-position of the given layer.

#### Prototype

```
int GUI_SetLayerPosEx(unsigned LayerIndex,  
                     int      xPos,  
                     int      yPos);
```

#### Parameters

| Parameter             | Description                        |
|-----------------------|------------------------------------|
| <a href="#">Index</a> | Layer index.                       |
| <a href="#">xPos</a>  | New X position of the given layer. |
| <a href="#">yPos</a>  | New Y position of the given layer. |

#### Additional information

To be able to use this function the hardware and the used display driver need to support layer positioning. If the driver does not support this feature the function returns immediately.

### 10.5.1.6 GUI\_SetLayerSizeEx()

#### Description

Sets the X- and Y-size of the given layer.

#### Prototype

```
int GUI_SetLayerSizeEx(unsigned LayerIndex,  
                      int      xSize,  
                      int      ySize);
```

#### Parameters

| Parameter             | Description                                       |
|-----------------------|---|
| <a href="#">Index</a> | Layer index.                                      |
| <a href="#">xSize</a> | New horizontal size in pixels of the given layer. |
| <a href="#">ySize</a> | New vertical size in pixels of the given layer.   |

#### Additional information

To be able to use this function the hardware and the used display driver need to support layer sizing. If the driver does not support this feature the function returns immediately.

### 10.5.1.7 GUI\_SetLayerVisEx()

#### Description

Sets the visibility of the given layer.

#### Prototype

```
int GUI_SetLayerVisEx(unsigned LayerIndex,  
                     int OnOff);
```

#### Parameters

| Parameter             | Description                                    |
|-----------------------|--|
| <a href="#">Index</a> | Layer index.                                   |
| <a href="#">OnOff</a> | 1 if layer should be visible, 0 for invisible. |

#### Additional information

To be able to use this function the hardware and the used display driver need to support this feature. If the driver does not support this feature the function returns immediately.

### 10.5.1.8 LCD\_GetNumLayers()

#### Description

Returns the number of layers configured in your configuration.

#### Prototype

```
int LCD_GetNumLayers(void);
```

#### Return value

Number of layers configured in your configuration.

## 10.5.2 SoftLayer specific functions

### 10.5.2.1 GUI\_SOFTLAYER\_Enable()

#### Description

Enables and configures SoftLayers.

#### Prototype

```
int GUI_SOFTLAYER_Enable(GUI_SOFTLAYER_CONFIG * pConfig,
                        int NumLayers,
                        GUI_COLOR CompositeColor);
```

#### Parameters

| Parameter                   | Description   |
|-----------------------------|---|
| <code>pConfig</code>        | Pointer to a GUI_SOFTLAYER_CONFIG data structure.                               |
| <code>NumLayers</code>      | Number of layers to create using the config data.                               |
| <code>CompositeColor</code> | The composite color is used in case certain areas do not contain opaque colors. |

#### Return value

0        on success  
1        on error.

#### Additional information

This function may be called only from within the function `LCD_X_Config()`. The function `LCD_X_Config()` is called automatically from `GUI_Init()`.

## 10.5.2.2 GUI\_SOFTLAYER\_Refresh()

### Description

Refreshes layers by rerendering the dirty area.

### Prototype

```
int GUI_SOFTLAYER_Refresh(void);
```

### Return value

- 0 if nothing was done
- 1 if something was done
- 2 on error.

### Additional information

This function is called from the function `GUI_Exec1()` if SoftLayers are enabled. After a refresh was performed, the dirty area gets cleared.

### 10.5.2.3 GUI\_SOFTLAYER\_SetCompositeColor()

#### Description

Sets the composite color.

#### Prototype

```
void GUI_SOFTLAYER_SetCompositeColor(U32 Color);
```

#### Parameters

| Parameter | Description                         |
|-----------|-------------------------------------|
| Color     | Color to be set as composite color. |

#### Additional information

The function `SIM_GUI_SetCompositeColor()` does not have an effect with SoftLayers.



### 10.5.2.4 GUI\_SOFTLAYER\_MULTIBUF\_Enable()

#### Description

Enables the automatic use of Multiple Buffering with SoftLayers.

#### Prototype

```
int GUI_SOFTLAYER_MULTIBUF_Enable(int OnOff);
```

#### Parameters

| Parameter | Description  |
|-----------|--|
| OnOff     | 0 to disable MultiBuffering support, 1 to enable MultiBuffering support. |

#### Return value

The function returns the previous setting.

- 0 if MultiBuffering has not been used
- 1 if MultiBuffering has already been used.

#### Additional information

If Multiple Buffering is enabled, the function `GUI_SOFTLAYER_Refresh()` automatically calls the function `GUI_MULTIBUF_BeginEx()` and `GUI_MULTIBUF_EndEx()`.

## 10.5.3 Data structures

### 10.5.3.1 GUI\_SOFTLAYER\_CONFIG

#### Description

Data structure used by `GUI_SOFTLAYER_Enable()` to configurate a soft layer.

#### Type definition

```
typedef struct {  
    int  xPos;  
    int  yPos;  
    int  xSize;  
    int  ySize;  
    int  Visible;  
} GUI_SOFTLAYER_CONFIG;
```

#### Structure members

| Member               | Description                   |
|----------------------|-------------------------------|
| <code>xPos</code>    | X-position.                   |
| <code>yPos</code>    | Y-position.                   |
| <code>xSize</code>   | X-size.                       |
| <code>ySize</code>   | Y-size.                       |
| <code>Visible</code> | 1 = visible, 0 = not visible. |

# Chapter 11

## Display drivers

---

A display driver supports a particular family of display controllers and all displays which are connected to one or more of these controllers. The drivers can be configured by modifying their configuration files whereas the driver itself does not need to be modified. The configuration files contain all required information for the driver including how the hardware is accessed and how the controller(s) are connected to the display.

This chapter provides an overview of the display drivers available for emWin. It explains the following in terms of each driver:

- Which display controllers can be accessed, as well as supported color depths and types of interfaces.
- RAM requirements.
- Driver specific functions.
- How to access the hardware.
- Special configuration switches.
- Special requirements for particular display controllers.

## 11.1 Available display drivers

Since emWin V5 the driver interface has changed. Old display drivers, developed for emWin V4 or earlier, are not longer supported.

The display driver interface was changed in order to be able to configure drivers at run-time. This was required because emWin is often used as a precompiled library which should not have to be changed when using a different display.

### Note

Creating a precompiled library including the source files of a compile time configurable driver precludes configurability using the library.

To be able to support as many display controllers as possible in a short period, we migrated some of the older drivers to the new interface. Not all migrated display drivers are runtime configurable. The listings below show the sets of available runtime and compile time configurable display drivers.

### 11.1.1 Driver file naming convention

All files belonging to the same display driver begin with the name of the driver. So all files called `<DriverName>*.*` describe the whole driver.

#### Example

The following files describe the `GUIDRV_IST3088` display driver:

- `GUIDRV_IST3088.c`
- `GUIDRV_IST3088.h`
- `GUIDRV_IST3088_4.c`
- `GUIDRV_IST3088_Private.h`
- `GUIDRV_IST3088_X_4.c`

### 11.1.2 Run-time configurable drivers

The following table lists the currently available run-time configurable drivers developed for the current interface of emWin:

| Driver                        | Purpose of driver   | Supported bits/pixel                   |
|-------------------------------|---|--|
| <code>GUIDRV_BitPlains</code> | This driver can be used for solutions without display controller. It manages separate 'bitplains' for each color bit. Initially it has been developed to support a solution for an R32C/111 which drives a TFT display without display controller. It can be used for each solution which requires the color bits in separate plains.   | 1 - 8                                  |
| <code>GUIDRV_DCache</code>    | Cache driver for managing a double cache. It manages the cache data separately from the driver and converts the data line by line immediately before a drawing operation is required. This driver makes it possible to use for example a 16bpp display driver in 1bpp mode with a cache which only requires 1 bit per pixel.  | 1 (can be enhanced on demand)          |
| <code>GUIDRV_Dist</code>      | This driver supports displays with multiple controllers.  | Depends on the actual display drivers. |
| <code>GUIDRV_FlexColor</code> | This driver supports a large number of different display-controllers, but they have one thing in common regarding the FrameBuffer management. This commonality is the method of accessing the FrameBuffer. The access to the FrameBuffer is done in two steps for all these controllers. First, the rectangular area to be written or read is defined. Then the linear output of the data or the reading of the corresponding data takes place. | 16, 18, 24                             |

| Driver          | Purpose of driver   | Supported bits/pixel   |
|-----------------|---|------------------------|
| GUIDRV_IST3088  | Support for some controllers of Integrated Solutions Technology Inc.  | 4                      |
| GUIDRV_Lin      | This driver supports every display controller with linear addressable video memory with a direct (full bus) interface. This means that the video RAM is directly addressable by the address lines of the CPU. The driver contains no controller specific code. So it can also be used for solutions without display controller which require a driver which only manages the video RAM. | 1, 2, 4, 8, 16, 24, 32 |
| GUIDRV_S1D13L01 | Display driver for Epson S1D13L01, indirect interface only.   | 8, 16                  |
| GUIDRV_S1D13L02 | Display driver for Epson S1D13L02, indirect interface only.   | 16                     |
| GUIDRV_S1D13L04 | Display driver for Epson S1D13L04, indirect interface only.   | 24, 32                 |
| GUIDRV_S1D13513 | Display driver for Epson S1D13513, indirect interface only.   | 24, 32                 |
| GUIDRV_S1D13748 | Display driver for Epson S1D13748, indirect interface only.   | 16                     |
| GUIDRV_S1D13781 | Display driver for Epson S1D13781, indirect interface only.   | 8, 16                  |
| GUIDRV_S1D15G00 | Display driver for Epson S1D15G00, indirect interface only.   | 12                     |
| GUIDRV_SH_MEM   | Display driver for Sharp memory LCDs with 8- or 10 bit address interface.   | 1, 3                   |
| GUIDRV_SLin     | This driver supports various display controllers with linear addressable FrameBuffer and indirect interface.  | 1, 2, 4                |
| GUIDRV_SLinEPD  | Driver for different ePaper display controller.   | 1                      |
| GUIDRV_SPage    | This driver supports different display controllers with indirect interface and page-wise organized FrameBuffer. A page is a horizontally associated array of bytes, where one byte contains 2-8 vertically arranged pixels depending on the color depth.  | 1, 2, 4                |
| GUIDRV_SSD1322  | Display driver for Solomon OLED controller SSD1322.   | 4                      |
| GUIDRV_SSD1926  | Display driver for Solomon SSD1926, indirect interface only.  | 8                      |
| GUIDRV_UC1698G  | Display driver for UltraChip UC1698G.   | 1, 5                   |

### 11.1.3 Compile-time configurable drivers

The following table lists the currently available drivers which has already been migrated to the current version of emWin:

| Driver                 | Purpose of driver   | Supported bits/pixel |
|------------------------|---|----------------------|
| GUIDRV_CompactColor_16 | Predecessor of GUIDRV_FlexColor.  | 16                   |
| GUIDRV_Fujitsu_16      | Display driver for Fujitsu MB87J2020 (Jasmine)<br>Display driver for Fujitsu MB87J2120 (Lavender) | 1, 2, 4, 8, 16       |
| GUIDRV_Page1bpp        | Predecessor of GUIDRV_SPage.  | 1                    |
| GUIDRV_07X1            | Display driver for some pane-wise organized display controllers with indirect interface.          | 2                    |
| GUIDRV_6331            | Display driver for some Samsung display controllers with indirect interface.                      | 16                   |
| GUIDRV_7528            | Display driver for Sitronix ST7528  | 4                    |
| GUIDRV_7529            | Display driver for Sitronix ST7529  | 1, 4, 5              |

#### Note

Some LCD-controllers may be supported twice, by a runtime and by a compile time configurable driver. In that case it is highly recommended to use/buy the runtime

configurable driver, because those drivers are the successors of the compile time configurable drivers.

### 11.1.4 Special purpose drivers

The basic package contains a driver which does not support a specific display controller. It can be used as template for a new driver or for measurement purpose:

| Driver          | LCD Controller  | Supported bits/pixel |
|-----------------|---|----------------------|
| GUIDRV_Template | Driver template. Can be used as a starting point for writing a new driver. Part of the basic package. | -                    |

## 11.2 CPU / Display controller interface

Different display controllers can have different CPU interfaces. Basically there are two different interfaces:

- Direct interface
- Indirect interface

Whereas the direct interface accesses the video memory directly by the address bus of the CPU, the indirect interface requires a more complex communication with the display controller to get access to the video memory. This can be done by different kinds of connections:

- Parallel access
- 4 pin SPI interface
- 3 pin SPI interface
- I2C bus interface

The following explains these interfaces and how to configure them. Note that not all configuration macros are always required. For details about which macros are required, refer to *Detailed display driver descriptions* on page 2961.

### 11.2.1 Direct interface

Some display controllers (especially those for displays with higher resolution) require a full address bus, which means they are connected to at least 14 address bits. In a direct interface configuration, video memory is directly accessible by the CPU; the address bus is connected to the display controller.

The only knowledge required when configuring a direct interface is information about the address range (which will generate a CHIP-SELECT signal for the LCD controller) and whether 8-, 16- or 32-bit accesses should be used (bus-width to the display controller). In other words, you need to know the following:

- Base address for video memory access
- Base address for register access
- Distance between adjacent video memory locations (usually 1/2/4-byte)
- Distance between adjacent register locations (usually 1/2/4-byte)
- Type of access (8/16/32-bit) for video memory
- Type of access (8/16/32-bit) for registers

#### Typical block diagram

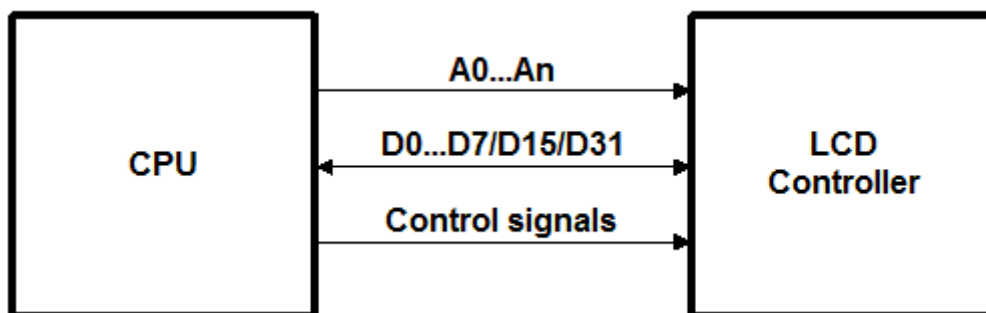

### 11.2.2 Indirect interface - Parallel bus

Most controllers for smaller displays use an indirect interface to connect to the CPU. With an indirect interface, only one address bit (usually A0) is connected to the LCD controller. Some of these controllers are very slow, so that the hardware designer may decide to connect it to input/output (I/O) pins instead of the address bus.

### Typical block diagram

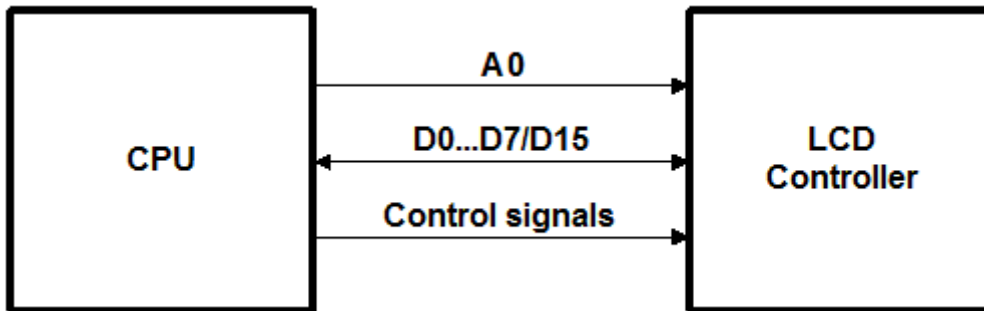

8 (16) data bits, one address bit and 2 or 3 control lines are used to connect the CPU and one LCD controller. Four macros inform the LCD driver how to access each controller used. If the LCD controller(s) is connected directly to the address bus of the CPU, configuration is simple and usually consists of no more than one line per macro. If the LCD controller(s) is connected to I/O pins, the bus interface must be simulated, which takes about 5-10 lines of program per macro (or a function call to a routine which simulates the bus interface). The signal **A0** is also called **C/D** (Command/Data), **D/I** (Data/Instruction) or **RS** (Register select), depending on the display controller.

#### 11.2.2.1 Example routines for connection to I/O pins

Examples can be found in the folder `Sample\LCD_X_Port`:

- `LCD_X_6800.c`, port routines for the 6800 parallel interface.
- `LCD_X_8080.c`, port routines for the 8080 parallel interface.

#### 11.2.3 Indirect interface - 4 pin SPI

Using a 4 pin SPI interface is very similar to a parallel interface. To connect a LCD display using 4 pin SPI interface the lines **A0**, **CLK**, **DATA**, and **CS** must be connected to the CPU.

##### Typical block diagram

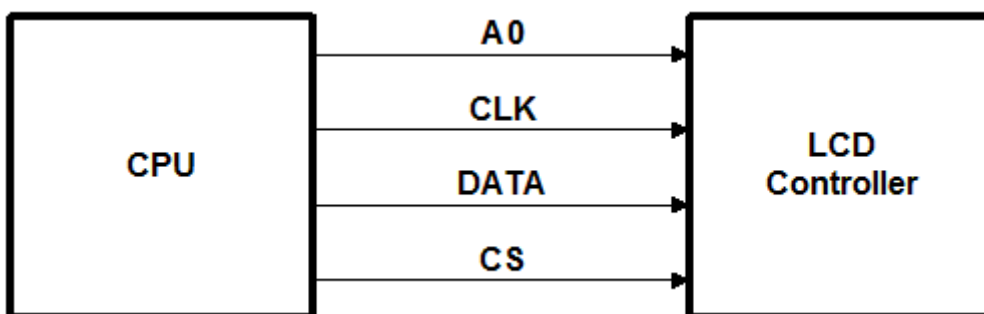

#### 11.2.3.1 Example routines for connection to I/O pins

An example can be found in the folder `Sample\LCD_X_Port`:

- `LCD_X_SERIAL.c`, port routines for a serial interface.

This sample uses port pins for the communication. This works very slow but can be used with each CPU. This should be optimized by the customer by using the hardware support of the CPU for this kind of communication.

#### 11.2.4 Indirect interface - 3 pin SPI

To connect a LCD display using 4 pin SPI interface the lines **CLK**, **DATA**, and **CS** must be connected to the CPU.



### Typical block diagram

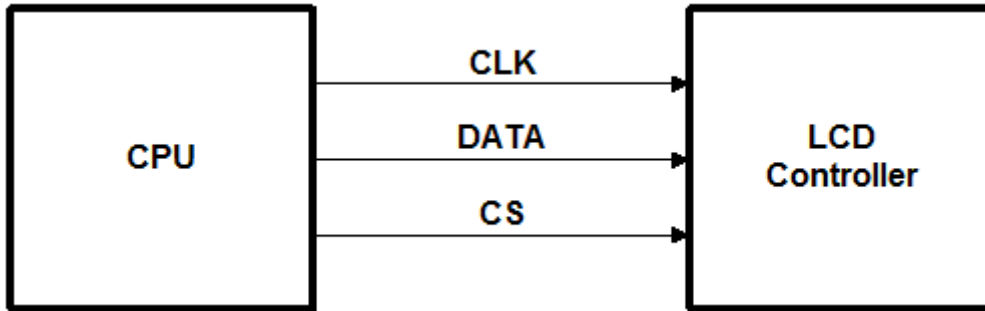

#### 11.2.4.1 Example routines for connection to I/O pins

This interface does not have a separate line for distinguish between data and commands to be transmitted to the display controller. There is no standardized method to manage this. Some controllers use an additional bit for distinguish between data and command, other controllers work different.

Examples can be found in the folder `Sample\LCD_X_Port`:

- `LCD_X_Serial_3Pin.c`, port routines for a 3 pin serial interface.
- `LCD_X_Serial_3Wire.c`, port routines for a 3 pin serial interface.

#### 11.2.5 Indirect interface - I2C bus

This kind of interface use only 2 lines and a standardized protocol for the communication with the display controller.

### Typical block diagram

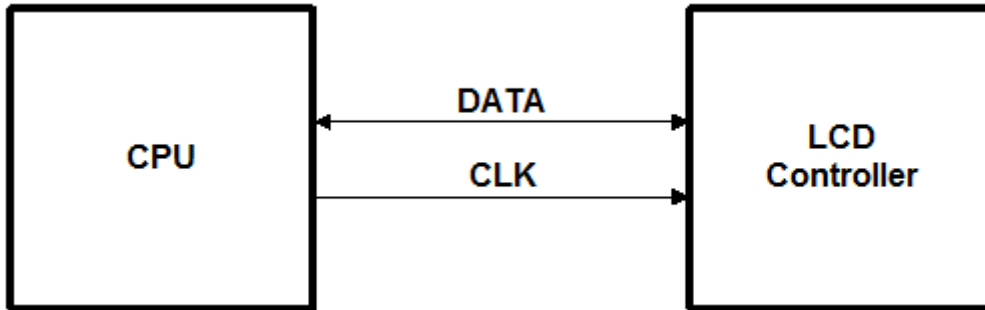

#### 11.2.5.1 Example routines for connection to I/O pins

An example can be found in the folder `Sample\LCD_X_Port`:

- `LCD_X_I2CBUS.c`, port routines for a I2C bus interface.

Similar to the serial communication examples this example uses port lines for the communication which works not very fast. If the CPU support this kind of communication these routines should be optimized by using the hardware functions.

## 11.3 Hardware interface configuration

The following explains how to configure the hardware communication between display driver and display controller.

### 11.3.1 Direct interface

Drivers which make use of a direct interface are usually configured by specifying the address of the video memory. In order to do so the function `LCD_SetVRAMAddrEx()` can be called. Details can be found in the section *Display driver API* on page 3100.

### 11.3.2 Indirect interface

There are 2 kinds of display drivers:

- Run-time configurable drivers
- Compile-time configurable drivers

Configuring these kinds of drivers works differently:

- Run-time configuration means the driver can be compiled without being configured. The configuration is done at run-time. This type of driver can still be configured at run-time when placed in a library.
- A compile-time configurable driver requires the configuration in a configuration header file, which is included at compile-time of the driver.

#### 11.3.2.1 Run-time configuration

Run-time configurable drivers do not need to be configured at compile time. So this drivers can be used in a precompiled library.

Each driver has its own function(s) for setting up the hardware interface. This is done by passing a pointer to a `GUI_PORT_API` structure containing function pointers to the hardware routines to be used:

##### 11.3.2.1.1 Elements of structure `GUI_PORT_API`

###### 8 bit interface

| Element                   | Data type                                       | Description   |
|---------------------------|---|---|
| <code>pfWrite8_A0</code>  | <code>void (*)(U8 Data)</code>                  | Pointer to a function which writes one byte to the controller with C/D line low.        |
| <code>pfWrite8_A1</code>  | <code>void (*)(U8 Data)</code>                  | Pointer to a function which writes one byte to the controller with C/D line high.       |
| <code>pfWriteM8_A0</code> | <code>void (*)(U8 * pData, int NumItems)</code> | Pointer to a function which writes multiple bytes to the controller with C/D line low.  |
| <code>pfWriteM8_A1</code> | <code>void (*)(U8 * pData, int NumItems)</code> | Pointer to a function which writes multiple bytes to the controller with C/D line high. |
| <code>pfRead8_A0</code>   | <code>U8 (*)(void)</code>                       | Pointer to a function which reads one byte from the controller with C/D line low.       |
| <code>pfRead8_A1</code>   | <code>U8 (*)(void)</code>                       | Pointer to a function which reads one byte from the controller with C/D line high.      |

| Element                     | Data type                                       | Description  |
|-----------------------------|---|--|
| <a href="#">pfReadM8_A0</a> | <code>void (*)(U8 * pData, int NumItems)</code> | Pointer to a function which reads multiple bytes from the controller with C/D line low.  |
| <a href="#">pfReadM8_A1</a> | <code>void (*)(U8 * pData, int NumItems)</code> | Pointer to a function which reads multiple bytes from the controller with C/D line high. |

## 16 bit interface

| Element                       | Data type  | Description  |
|-------------------------------|--|--|
| <a href="#">pfWrite16_A0</a>  | <code>void (*)(U16 Data)</code>                  | Pointer to a function which writes one 16 bit value to the controller with C/D line low.         |
| <a href="#">pfWrite16_A1</a>  | <code>void (*)(U16 Data)</code>                  | Pointer to a function which writes one 16 bit value to the controller with C/D line high.        |
| <a href="#">pfWriteM16_A0</a> | <code>void (*)(U16 * pData, int NumItems)</code> | Pointer to a function which writes multiple 16 bit values to the controller with C/D line low.   |
| <a href="#">pfWriteM16_A1</a> | <code>void (*)(U16 * pData, int NumItems)</code> | Pointer to a function which writes multiple 16 bit values to the controller with C/D line high.  |
| <a href="#">pfRead16_A0</a>   | <code>U16 (*)(void)</code>                       | Pointer to a function which reads one 16 bit value from the controller with C/D line low.        |
| <a href="#">pfRead16_A1</a>   | <code>U16 (*)(void)</code>                       | Pointer to a function which reads one 16 bit value from the controller with C/D line high.       |
| <a href="#">pfReadM16_A0</a>  | <code>void (*)(U16 * pData, int NumItems)</code> | Pointer to a function which reads multiple 16 bit values from the controller with C/D line low.  |
| <a href="#">pfReadM16_A1</a>  | <code>void (*)(U16 * pData, int NumItems)</code> | Pointer to a function which reads multiple 16 bit values from the controller with C/D line high. |
| <a href="#">pfReadM32_A1</a>  | <code>void (*)(U32 * pData, int NumItems)</code> | Pointer to a function which reads multiple 32 bit values from the controller with C/D line high. |

## 32 bit interface

| Element                      | Data type                       | Description   |
|------------------------------|---------------------------------|---|
| <a href="#">pfWrite32_A0</a> | <code>void (*)(U32 Data)</code> | Pointer to a function which writes one 32 bit value to the controller with C/D line low.  |
| <a href="#">pfWrite32_A1</a> | <code>void (*)(U32 Data)</code> | Pointer to a function which writes one 32 bit value to the controller with C/D line high. |

| Element                    | Data type  | Description  |
|----------------------------|--|--|
| <code>pfWriteM32_A0</code> | <code>void (*)(U32 * pData, int NumItems)</code> | Pointer to a function which writes multiple 32 bit values to the controller with C/D line low.   |
| <code>pfWriteM32_A1</code> | <code>void (*)(U32 * pData, int NumItems)</code> | Pointer to a function which writes multiple 32 bit values to the controller with C/D line high.  |
| <code>pfRead32_A0</code>   | <code>U32 (*)(void)</code>                       | Pointer to a function which reads one 32 bit value from the controller with C/D line low.        |
| <code>pfRead32_A1</code>   | <code>U32 (*)(void)</code>                       | Pointer to a function which reads one 32 bit value from the controller with C/D line high.       |
| <code>pfReadM32_A0</code>  | <code>void (*)(U32 * pData, int NumItems)</code> | Pointer to a function which reads multiple 32 bit values from the controller with C/D line low.  |
| <code>pfReadM32_A1</code>  | <code>void (*)(U32 * pData, int NumItems)</code> | Pointer to a function which reads multiple 32 bit values from the controller with C/D line high. |

## SPI interface

| Element              | Data type                           | Description  |
|----------------------|-------------------------------------|--|
| <code>pfSetCS</code> | <code>void (*)(U8 NotActive)</code> | Pointer to a function which is able to toggle the CS signal of the controller. |

This structure contains function pointers for 8-, 16- and 32 bit access. Not all function pointers are used by each driver. The required functions are listed in the description of the according display driver.

## Example

The following shows a configuration example for the driver `GUIDRV_SLin`. It creates and configures the driver, initializes the required function pointers of the `GUI_PORT_API` structure and passes them to the driver:

```

GUI_DEVICE * pDevice;
CONFIG_SLIN Config = {0};
GUI_PORT_API PortAPI = {0};
//
// Set display driver and color conversion
//
pDevice = GUI_DEVICE_CreateAndLink(GUIDRV_SLIN_2, GUICC_2, 0, 0);
//
// Common display driver configuration
//
LCD_SetSizeEx (0, XSIZE, YSIZE);
LCD_SetVSizeEx(0, XSIZE, YSIZE);
//
// Driver specific configuration
//
Config.UseCache = 1;
GUIDRV_SLin_Config(pDevice, &Config);

```

```
//
// Select display controller
//
GUIDRV_SLin_SetS1D13700(pDevice);
//
// Setup hardware access routines
//
PortAPI.pfWrite16_A0 = _Write0;
PortAPI.pfWrite16_A1 = _Write1;
PortAPI.pfWriteM16_A0 = _WriteM0;
PortAPI.pfRead16_A1 = _Read1;
GUIDRV_SLin_SetBus8(pDevice, &PortAPI);
```

Details can be found in the descriptions of the run-time configurable drivers.

### 11.3.2.2 Compile-time configuration

A compile-time configurable driver requires its configuration in a header file. This configuration file is included when compiling the display driver. The compile-time configurable drivers use distinct macros for accessing the hardware. It depends on the interface details which macros are used. The following shows which macros are used by which kind of interface.

#### Macros used by an indirect interface

The following table shows the used hardware access macros:

| Type | Macro         | Description   |
|------|---------------|---|
| F    | LCD_READ_A0   | Reads a byte from LCD controller with A0 - line low.            |
| F    | LCD_READ_A1   | Reads a byte from LCD controller with A0 - line high.           |
| F    | LCD_WRITE_A0  | Writes a byte to the display controller with A0 - line low.     |
| F    | LCD_WRITE_A1  | Writes a byte to the display controller with A0 - line high.    |
| F    | LCD_WRITEM_A1 | Writes several bytes to the LCD controller with A0 - line high. |

#### Macros used by a 4 pin SPI interface

The following table shows the used hardware access macros:

| Type | Macro         | Description   |
|------|---------------|---|
| F    | LCD_WRITE_A0  | Writes a byte to the display controller with A0 (C/D) - line low.     |
| F    | LCD_WRITE_A1  | Writes a byte to the display controller with A0 (C/D) - line high.    |
| F    | LCD_WRITEM_A1 | Writes several bytes to the LCD controller with A0 (C/D) - line high. |

#### Macros used by a 3 pin SPI interface

The following table shows the used hardware access macros:

| Type | Macro      | Description                                 |
|------|------------|---|
| F    | LCD_WRITE  | Writes a byte to the display controller.    |
| F    | LCD_WRITEM | Writes several bytes to the LCD controller. |

#### Macros used by a I2C bus interface

The following table shows the used hardware access macros:

| Type | Macro        | Description  |
|------|--------------|--|
| F    | LCD_READ_A0  | Reads a status byte from LCD controller.             |
| F    | LCD_READ_A1  | Reads a data byte from LCD controller.               |
| F    | LCD_WRITE_A0 | Writes a instruction byte to the display controller. |
| F    | LCD_WRITE_A1 | Writes a data byte to the display controller.        |

| Type | Macro         | Description                                      |
|------|---------------|--|
| F    | LCD_WRITEM_A1 | Writes several data bytes to the LCD controller. |

### 11.3.2.2.1 LCD\_READ\_A0

#### Description

Reads a byte from LCD controller with A0 (C/D) - line low.

#### Type

Function replacement

#### Prototype

```
#define LCD_READ_A0(Result)
```

| Parameter           | Description   |
|---------------------|---|
| <code>Result</code> | Result read. This is not a pointer, but a placeholder for the variable in which the value will be stored. |

### 11.3.2.2.2 LCD\_READ\_A1

#### Description

Reads a byte from LCD controller with A0 (C/D) - line high.

#### Type

Function replacement

#### Prototype

```
#define LCD_READ_A1(Result)
```

| Parameter           | Description   |
|---------------------|---|
| <code>Result</code> | Result read. This is not a pointer, but a placeholder for the variable in which the value will be stored. |

### 11.3.2.2.3 LCD\_WRITE\_A0

#### Description

Writes a byte to the display controller with A0 (C/D) - line low.

#### Type

Function replacement

#### Prototype

```
#define LCD_WRITE_A0(Byte)
```

| Parameter         | Description    |
|-------------------|----------------|
| <code>Byte</code> | Byte to write. |

### 11.3.2.2.4 LCD\_WRITE\_A1

#### Description

Writes a byte to the display controller with A0 (C/D) - line low.

#### Type

Function replacement

#### Prototype

```
#define LCD_WRITE_A1(Byte)
```

| Parameter | Description    |
|-----------|----------------|
| Byte      | Byte to write. |

### 11.3.2.2.5 LCD\_WRITEM\_A1

#### Description

Writes several bytes to the LCD controller with A0 (C/D) - line high.

#### Type

Function replacement

#### Prototype

```
#define LCD_WRITEM_A1(paBytes, NumberOfBytes)
```

| Parameter     | Description   |
|---------------|---|
| paBytes       | Placeholder for the pointer to the first data byte. |
| NumberOfBytes | Number of data bytes to be written.                 |

### 11.3.2.2.6 LCD\_WRITE

#### Description

Writes a byte to the LCD controller.

#### Type

Function replacement

#### Prototype

```
#define LCD_WRITE(Byte)
```

| Parameter | Description    |
|-----------|----------------|
| Byte      | Byte to write. |

### 11.3.2.2.7 LCD\_WRITEM

#### Description

Writes several bytes to the LCD controller.

#### Type

Function replacement

## Prototype

```
#define LCD_WRITEM(paBytes, NumberOfBytes)
```

| Parameter                  | Description   |
|----------------------------|---|
| <code>paBytes</code>       | Placeholder for the pointer to the first data byte. |
| <code>NumberOfBytes</code> | Number of data bytes to be written.                 |



## 11.4 Non readable displays

Some display controllers with an indirect interface do not support reading back display data. Especially displays which are connected via SPI interface often have this limitation. In this case we recommend using a display data cache. For details how to enable a display data cache, refer to *Detailed display driver descriptions* on page 2961.

On systems with a very small RAM it is sometimes not possible to use a display data cache. If a display is not readable and a display data cache can not be used some features of emWin will not work. The list below shows these features:

- Cursors and Sprites
- XOR-operations, required for text cursors in EDIT and MULTIEDIT widgets
- Alpha blending
- Antialiasing

This is valid for all drivers where one data unit (8 or 16 bit) represents one pixel. Display drivers, where one data unit represents more than one pixel, can not be used if no display data cache is available and the display is not readable. An example is the `GUIDRV_Page1bpp` driver where one byte represents 8 pixels.

## 11.5 Display orientation

If the original display orientation does not match the requirements, there are different ways to change the display orientation:

- Driver based configuration of the desired orientation
- Runtime rotation
- Using `GUI_SetOrientation()`

### 11.5.1 Driver based configuration of display orientation

If the display driver supports different orientations it is recommended to use the driver for setting up the right orientation. The way how to configure the display orientation then depends on the display driver to be used. Whereas the display orientation of the most common drivers is run-time configurable some drivers need to be configured at compile time.

#### 11.5.1.1 Run-time configuration







The display orientation of the most common driver is determined by creating the display driver device in `LCD_X_Config()` using the proper macro. The according macros are listed within the description of `GUIDRV_Lin` on page 2994.



#### 11.5.1.2 Compile-time configuration

The display orientation of some drivers with indirect interface like `GUIDRV_CompactColor_16` needs to be configured at compile time in the configuration file of the driver.

#### Display orientations

There are 8 possible display orientations; the display can be turned 0°, 90°, 180° or 270° and can also be viewed from top or from bottom. The default orientation is 0° and top view. These  $4 * 2 = 8$  different display orientations can also be expressed as a combination of 3 binary switches: X-mirroring, Y-mirroring and X/Y swapping. For this purpose, the binary configuration macros listed below can be used with each driver in any combination. If your display is not oriented well, take a look at the config switches in the table below to make it work properly. The orientation is handled as follows: Mirroring in X and Y first, then swapping (if selected).

| Display   | Orientation macros in driver configuration file | Display  | Orientation macros in driver configuration file                            |
|---|---|--|--|
|  | No orientation macro required                   |  | <code>#define LCD_MIRROR_Y 1</code>  |
|  | <code>#define LCD_MIRROR_X 1</code>             |  | <code>#define LCD_MIRROR_X 1</code><br><code>#define LCD_MIRROR_Y 1</code> |
|  | <code>#define LCD_SWAP_XY 1</code>              |   | <code>#define LCD_SWAP_XY 1</code><br><code>#define LCD_MIRROR_Y 1</code>  |

| Display   | Orientation macros in driver configuration file         | Display   | Orientation macros in driver configuration file                                |
|---|---|---|--|
|  | <pre>#define LCD_SWAP_XY 1 #define LCD_MIRROR_X 1</pre> |  | <pre>#define LCD_SWAP_XY 1 #define LCD_MIRROR_X 1 #define LCD_MIRROR_Y 1</pre> |

Details on how to use multiple orientations simultaneously can be found in the section *Run-time screen rotation* on page 2908.

## 11.5.2 Runtime rotation

The runtime rotation functions make it possible to change the current driver at runtime. It allows to add up to 7 drivers to the primarily configured (default) driver of a layer. Basically usage is the following:

- Basic driver setup (default driver) in `LCD_X_Config()`.
- Add additional drivers to be used for different orientations.
- Optionally set a configuration callback routine.
- Use the API functions to change the driver.

When selecting a driver the current one will be deleted and unlinked and a new one is created and linked into the device chain of the layer. Immediately after creating a new driver the configuration callback function is called before the driver will be initialized. The color configuration to be used when creating and linking a driver is taken from the default driver.

The following set of functions may be used:

| Routine                               | Description  |
|---------------------------------------|--|
| <code>LCD_ROTATE_AddDriver()</code>   | Adds a driver to be used for display rotation.                             |
| <code>LCD_ROTATE_AddDriverEx()</code> | Adds a driver to be used for display rotation of the given layer.          |
| <code>LCD_ROTATE_DecSel()</code>      | Decrements the current selection.  |
| <code>LCD_ROTATE_DecSelEx()</code>    | Decrements the current selection of the given layer.                       |
| <code>LCD_ROTATE_IncSel()</code>      | Increments the current selection.  |
| <code>LCD_ROTATE_IncSelEx()</code>    | Increments the current selection of the given layer.                       |
| <code>LCD_ROTATE_SetCallback()</code> | Sets a function to be called immediately after a driver has been selected. |
| <code>LCD_ROTATE_SetSel()</code>      | Selects the driver with the given index to be used.                        |
| <code>LCD_ROTATE_SetSelEx()</code>    | Selects the driver with the given index to be used for the given layer.    |

### 11.5.2.1 LCD\_ROTATE\_AddDriver()

#### Description

Adds a driver to be used for display rotation. It is recommended that it is a variant of the default driver with different orientation.

#### Prototype

```
int LCD_ROTATE_AddDriver(const GUI_DEVICE_API * pDriver);
```

#### Parameters

| Parameter            | Description                      |
|----------------------|----------------------------------|
| <code>pDriver</code> | Pointer to a display driver API. |

#### Return value

0        on success.  
1        on error.

## 11.5.2.2 LCD\_ROTATE\_AddDriverEx()

### Description

Adds a driver to be used for display rotation of the given layer. It is recommended that it is a variant of the default driver with different orientation.

### Prototype

```
int LCD_ROTATE_AddDriverEx(const GUI_DEVICE_API * pDeviceAPI,  
                           int LayerIndex);
```

### Parameters

| Parameter                  | Description                      |
|----------------------------|----------------------------------|
| <a href="#">pDriver</a>    | Pointer to a display driver API. |
| <a href="#">LayerIndex</a> | Layer index to be used.          |

### Return value

0        on success.  
1        on error.

### 11.5.2.3 LCD\_ROTATE\_DecSel()

#### Description

Decrements the current selection. If the current driver is the default driver it selects the driver last added.

#### Prototype

```
int LCD_ROTATE_DecSel(void);
```

#### Return value

|   |             |
|---|-------------|
| 0 | on success. |
| 1 | on error.   |

## 11.5.2.4 LCD\_ROTATE\_DecSelEx()

### Description

Decrements the current selection of the given layer. If the current driver is the default driver it selects the driver last added.

### Prototype

```
int LCD_ROTATE_DecSelEx(int LayerIndex);
```

### Parameters

| Parameter  | Description             |
|------------|-------------------------|
| LayerIndex | Layer index to be used. |

### Return value

0        on success.  
1        on error.

### 11.5.2.5 LCD\_ROTATE\_IncSel()

#### Description

Increments the current selection. If the current driver is the last driver it selects the default driver.

#### Prototype

```
int LCD_ROTATE_IncSel(void);
```

#### Return value

|   |             |
|---|-------------|
| 0 | on success. |
| 1 | on error.   |



## 11.5.2.6 LCD\_ROTATE\_IncSelEx()

### Description

Increments the current selection of the given layer. If the current driver is the last driver it selects the default driver.

### Prototype

```
int LCD_ROTATE_IncSelEx(int LayerIndex);
```

### Parameters

| Parameter               | Description             |
|-------------------------|-------------------------|
| <code>LayerIndex</code> | Layer index to be used. |

### Return value

0        on success.  
1        on error.

### 11.5.2.7 LCD\_ROTATE\_SetCallback()

#### Description

Sets a function to be called immediately after a driver has been selected. It is called immediately after creation and before initializing.

#### Prototype

```
int LCD_ROTATE_SetCallback(void ( *pcbConfig)(GUI_DEVICE * , int , int ),
                           int LayerIndex);
```

#### Parameters

| Parameter                | Description                                |
|--------------------------|--|
| <code>pCbOnConfig</code> | Function to be called to configure driver. |

#### Return value

0        on success.  
1        on error.

#### Additional information

Main purpose of that function is to set a routine which is called by emWin to configure all properties of the driver. It is called immediately after selecting a driver. At least the display size has to be configured. In general it has to configure all things which normally are set in `LCD_X_Config()`.

### 11.5.2.8 LCD\_ROTATE\_SetSel()

#### Description

Selects the driver with the given index to be used.

#### Prototype

```
int LCD_ROTATE_SetSel(int Index);
```

#### Parameters

| Parameter             | Description                                |
|-----------------------|--|
| <a href="#">Index</a> | Zero-based index of the driver to be used. |

#### Return value

0        on success.  
1        on error.

### 11.5.2.9 LCD\_ROTATE\_SetSelEx()

#### Description

Selects the driver with the given index to be used for the given layer.

#### Prototype

```
int LCD_ROTATE_SetSelEx(int Index,  
                        int LayerIndex);
```

#### Parameters

| Parameter                  | Description                                |
|----------------------------|--|
| <a href="#">Index</a>      | Zero-based index of the driver to be used. |
| <a href="#">LayerIndex</a> | Layer to be used.                          |

#### Return value

0        on success.  
1        on error.

### 11.5.3 Function based configuration of display orientation

Another possibility to set up the display orientation is to call `GUI_SetOrientation()`. Using these functions is recommended if the display driver can not be used.

| Routine                             | Description  |
|-------------------------------------|--|
| <code>GUI_SetOrientation()</code>   | This function changes the display orientation by using a rotation device.                |
| <code>GUI_SetOrientationEx()</code> | This function changes the orientation in the specified layer by using a rotation device. |

### 11.5.3.1 GUI\_SetOrientation()

#### Description









This function changes the display orientation by using a rotation device.

#### Prototype

```
int GUI_SetOrientation(int Orientation);
```

#### Parameters

| Parameter   | Description  |
|-------------|--|
| Orientation | See the table below for an overview of valid values. |

| Resulting display   | Value to use for GUI_SetOrientation() | Resulting display   | Value to use for GUI_SetOrientation()     |
|---|---------------------------------------|---|---|
|    | 0                                     |   | GUI_MIRROR_Y                              |
|    | GUI_MIRROR_X                          |   | GUI_MIRROR_X   GUI_MIRROR_Y               |
|   | GUI_SWAP_XY                           |   | GUI_SWAP_XY   GUI_MIRROR_Y                |
|  | GUI_SWAP_XY   GUI_MIRROR_X            |  | GUI_SWAP_XY   GUI_MIRROR_X   GUI_MIRROR_Y |

#### Return value

- 0 on success.
- 1 on error.

#### Additional information

The rotation device covers the complete virtual screen within an internal screen buffer. Because of this the use of this function requires additional memory for this additional screen buffer. The number of required bytes can be calculated as follows:

$$\text{Virtual xSize} * \text{Virtual ySize} * \text{BytesPerPixel}$$

The number of bytes per pixel is for configurations from 1-8bpp 1, for systems with more than 8bpp up to 16bpp 2 and for systems with more than 16bpp 4. Each drawing operation first updates this buffer. After this the affected pixels are passed to the display driver device.

### 11.5.3.2 GUI\_SetOrientationEx()

#### Description

This function changes the orientation in the specified layer by using a rotation device.

#### Prototype

```
int GUI_SetOrientationEx(int Orientation,  
                        int LayerIndex);
```

#### Parameters

| Parameter                   | Description  |
|-----------------------------|--|
| <a href="#">Orientation</a> | Refer to <i>GUI_SetOrientation</i> on page 2954 for an overview of valid values. |
| <a href="#">LayerIndex</a>  | Index of the layer which <a href="#">Orientation</a> has to be (re-)configured.  |

#### Return value

0        on success.  
1        on error.

#### Additional information

See `GUI_SetOrientation()`.

## 11.5.4 Orientation flags

### Description

Flags used by several GUI functions to define the display orientation.

### Definition

```
#define GUI_MIRROR_X    (1 << 0)
#define GUI_MIRROR_Y    (1 << 1)
#define GUI_SWAP_XY     (1 << 2)
```

### Symbols

| Definition                   | Description             |
|------------------------------|-------------------------|
| <a href="#">GUI_MIRROR_X</a> | Mirroring the X-axis.   |
| <a href="#">GUI_MIRROR_Y</a> | Mirroring the Y-axis.   |
| <a href="#">GUI_SWAP_XY</a>  | Swapping X- and Y-axis. |



## 11.6 Display driver callback function

A display driver requires a callback function. It is called by the driver for several tasks. One task is putting the display driver into operation which is also explained in the chapter *Configuration* on page 100. It is also called for other tasks which require hardware related operations like switching the display on and off or setting a lookup table entry.

### Note

Refer to `LCD_X_DisplayDriver()` for a full API description of the function.

### 11.6.1 Commands passed to the callback function

The following explains the common commands passed to the callback function. For details about display driver specific commands, refer to *Detailed display driver descriptions* on page 2961. They are described under the topic 'Additional callback commands'.

#### 11.6.1.1 LCD\_X\_INITCONTROLLER

##### Description

As mentioned above the application should initialize the display controller and put it into operation if the callback routine receives this command. No parameters are passed on this command. Typically an initialization routine which initializes the registers of the display controller should be called in reaction of this command.

##### Parameters

None.

#### 11.6.1.2 LCD\_X\_ON

##### Description

This command switches the display on.

##### Parameters

None.

#### 11.6.1.3 LCD\_X\_OFF

##### Description

This command switches the display off.

##### Parameters

None.

#### 11.6.1.4 LCD\_X\_SETALPHA

##### Description

Sets the required layer alpha value. Should be used to set up the layer alpha register.

##### Parameters

`pData` points to a data structure of type `LCD_X_SETALPHA_INFO`.

### Elements of structure LCD\_X\_SETALPHA\_INFO

| Data type | Element | Description   |
|-----------|---------|---|
| int       | Alpha   | Alpha value to be used. 255 for transparent and 0 for opaque. |

### 11.6.1.5 LCD\_X\_SETLUTENTRY

#### Description

A lookup table entry should be set. The typical reaction should be writing an entry into the lookup table of the display controller.

#### Parameters

`pData` points to a data structure of type `LCD_X_SETLUTENTRY_INFO`.

### Elements of structure LCD\_X\_SETLUTENTRY\_INFO

| Data type | Element | Description  |
|-----------|---------|--|
| LCD_COLOR | Color   | RGB value of the color to be written to the LUT. Note that the format required by the hardware could be different to the RGB format. |
| U8        | Pos     | Zero based index of the LUT entry to be set.   |

### 11.6.1.6 LCD\_X\_SETORG

#### Description

The function is used in relation with virtual screens. It is called if the origin of the display should be set. A typical reaction can be modifying the frame buffer start address.

#### Parameters

`pData` points to a data structure of type `LCD_X_SETORG_INFO`.

### Elements of structure LCD\_X\_SETORG\_INFO

| Data type | Element | Description  |
|-----------|---------|--|
| int       | xPos    | New X-position of the physical display position within the virtual screen. |
| int       | yPos    | New Y-position of the physical display position within the virtual screen. |

### 11.6.1.7 LCD\_X\_SETPOS

#### Description

This function is used in relation with setting up the layer position. Please note that normally a layer could not exceed the physical range of a display. But it is possible to achieve the effect of a layer positioned outside of the display without modifying the content of the frame buffer. Such an effect could be used for example for moving a picture into the visible area of the display and/or for shifting it out of the display without any additional CPU load for repainting.

If for example a layer should look like starting with a negative X/Y-coordinate, for example (-10, -5) that values could not be used directly for setting up the registers of the layer position. The physical layer coordinate needs to be (0, 0) in that case. To achieve the effect of a negative position an offset needs to be added to the framebuffer start address. Further the visible length and height of the layer need to be adapted by subtracting the intersection

in X and Y. If the given coordinates (for example passed to `GUI_SetLayerPosEx()`) lead into a completely invisible layer `emWin` automatically sends a `LCD_X_SETVIS` command.

### Parameters

`pData` points to a data structure of type `LCD_X_SETPOS_INFO`.

### Elements of structure `LCD_X_SETPOS_INFO`

| Data type | Element       | Description   |
|-----------|---------------|---|
| int       | xPos          | Physical X-position to be used to set up the layer position register. |
| int       | yPos          | Physical Y-position to be used to set up the layer position register. |
| int       | xLen          | Physical X-size of the layer.   |
| int       | yLen          | Physical Y-size of the layer.   |
| int       | BytesPerPixel | Bytes used for one pixel.   |
| U32       | Off           | Offset to be added to the framebuffer start address.                  |

### Requirements

To be able to use that functionality the following must be possible:

- A stride register should exist which defines the number of bytes from one line of frame buffer data to the next line.
- It must be possible to set up the frame buffer start address to any pixel address.
- The size of the visual area of the layer must be configurable.

## 11.6.1.8 LCD\_X\_SETSIZE

### Description

Used to set up the size of a layer at runtime.

### Parameters

`pData` points to a data structure of type `LCD_X_SETSIZE_INFO`.

### Elements of structure `LCD_X_SETSIZE_INFO`

| Data type | Element | Description                                |
|-----------|---------|--|
| int       | xSize   | New X-size to be used for the given layer. |
| int       | ySize   | New Y-size to be used for the given layer. |

### Additional information

After changing the size of a layer at runtime normally the content of the layer needs to be repainted. Please note that this is not done automatically.

## 11.6.1.9 LCD\_X\_SETVIS

### Description

Used to set up the visibility of a layer at runtime.

### Parameters

`pData` points to a data structure of type `LCD_X_SETVIS_INFO`.

### Elements of structure LCD\_X\_SETVIS\_INFO

| Data type | Element | Description                                    |
|-----------|---------|--|
| int       | OnOff   | 1 if layer should be visible, 0 for invisible. |

### 11.6.1.10 LCD\_X\_SETVRAMADDR

#### Description

This command is passed by the driver to tell the callback routine the start address of the video RAM. The typical reaction should be writing the address to the frame buffer start address register.

#### Parameters

[pData](#) points to a data structure of type LCD\_X\_SETVRAMADDR\_INFO.

### Elements of structure LCD\_X\_SETVRAMADDR\_INFO

| Data type | Element | Description   |
|-----------|---------|---|
| void *    | pVRAM   | Points to the start address of the video RAM. This address is typically written to the video RAM base address register of the display controller. |

### 11.6.1.11 LCD\_X\_SHOWBUFFER

#### Description

This command is used in relation with multiple buffers. It tells the callback routine that the buffer with the given index should become visible.

#### Parameters

[pData](#) points to a data structure of type LCD\_X\_SHOWBUFFER\_INFO.

### Elements of structure LCD\_X\_SHOWBUFFER\_INFO

| Data type | Element | Description  |
|-----------|---------|--|
| int       | Index   | Index of buffer which should become visible as soon as possible. |

#### Additional information

Making the buffer visible could be done by setting the right framebuffer start address immediately or by doing that within an ISR which is called in the vertical non display period.

## 11.7 Detailed display driver descriptions

### 11.7.1 GUIDRV\_BitPlains

This driver has been developed for systems without display controller. It manages each color bit in a separate plain. This means if the color depth is for example 4 bits per pixel the driver manages 4 bit plains each containing one bit.

Initially the driver has been made to drive monochrome and color TFTs with an R323C/111 CPU via SPI interface. But the driver can be used also for similar applications.

The driver does only manage the content of the bit plains. It does not contain any display controller specific code.

#### 11.7.1.1 Supported hardware

##### Controllers

None.

##### Bits per pixel

The driver has been developed for a color depth of 1 to 8 bits per pixel.

##### Interface

It is required to write an application defined routine which uses the content of the bit plains to generate the color signals for the display. The driver comes with a sample for the R32C/111 CPU which refreshes the display via timer interrupt routine using the SPI interface.

#### 11.7.1.2 Driver selection

To use GUIDRV\_BitPlains for the given display, the following command can be used e.g.:

```
pDevice = GUI_DEVICE_CreateAndLink(GUIDRV_BITPLAINS, GUICC_M111, 0, 0);
```

More information about using the proper palette mode can be found in the chapter *Colors* on page 478.

### 11.7.1.3 Display data RAM organization

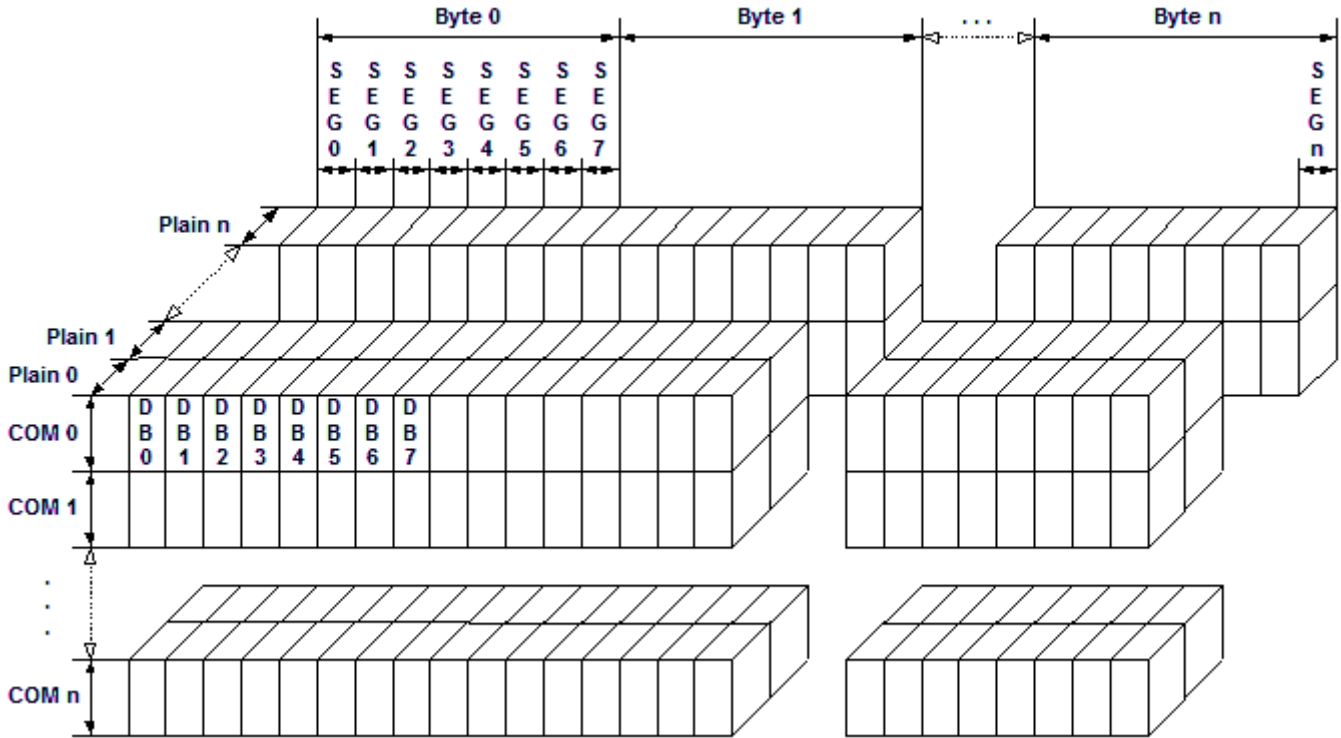

The picture above shows the relation between the display memory and the SEG and COM lines of the display. The display memory is divided into separate plains for each bit of the colors. This means that bit 0 of each pixel is stored in plain 0, the bit 1 in plain 1 and so on. The advantage of this method is that each color bit of the display data can be accessed very quickly.

### 11.7.1.4 RAM requirements

The required size of the display memory area can be calculated as follows:

```
Size = BitsPerPixel * (LCD_XSIZE + 7) / 8 * LCD_YSIZE
```

**Note**

The pointers to the bit plain areas need to be passed to the configuration routine of the driver. They are not allocated within the driver but from application side.

### 11.7.1.5 Hardware configuration

Normally, the hardware interface is an interrupt service routine (ISR) which updates the display. The driver comes with an example written in "C" code. This routine should serve as an example.

### 11.7.1.6 Additional run-time configuration

The table below shows the available run-time configuration routines of this driver:

| Routine                                | Description  |
|--|--|
| <code>GUIDRV_BitPlains_Config()</code> | This function passes a pointer to a <code>CONFIG_BITPLAINS</code> structure to the driver. |
| <code>LCD_SetVRAMAddrEx()</code>       | Sets the address of the video RAM.   |

**Elements of structure CONFIG\_VRAM\_BITPLAINS**

| Data type | Element | Description   |
|-----------|---------|---|
| U8 *      | apVRAM  | Array of pointers to the memory locations to be used by the driver for each bit plain. If the driver for example works in 2bpp mode only the first 2 pointers are used (One plain for each bit of the color information). |

### 11.7.1.7 GUIDRV\_BitPlains\_Config()

#### Description

This function passes a pointer to a CONFIG\_BITPLAINS structure to the driver.

#### Prototype

```
void GUIDRV_BitPlains_Config(GUI_DEVICE      * pDevice,
                             CONFIG_BITPLAINS * pConfig);
```

#### Parameters

| Parameter            | Description  |
|----------------------|--|
| <code>pDevice</code> | Pointer to the driver device.                            |
| <code>pConfig</code> | Pointer to a CONFIG_BITPLAINS structure explained below. |

#### Elements of structure CONFIG\_BITPLAINS

| Data type | Element | Description   |
|-----------|---------|---|
| int       | Mirror  | Config switch to mirror the bits of the display data. |

#### Configuration example

```
//
// Data arrays to be used by the display driver
//
static U8 _aPlain_0[BYTES_PER_LINE * YSIZE_PHYS];
static U8 _aPlain_1[BYTES_PER_LINE * YSIZE_PHYS];
static U8 _aPlain_2[BYTES_PER_LINE * YSIZE_PHYS];
//
// Structure to be passed to the driver
//
static struct {
    U8 * apVRAM[8];
} _VRAM_Desc = {
    _aPlain_0,
    _aPlain_1,
    _aPlain_2,
};
void LCD_X_Config(void) {
    //
    // Set display driver and color conversion for 1st layer
    //
    GUI_DEVICE_CreateAndLink(GUIDRV_BITPLAINS, COLOR_CONVERSION, 0, 0);
    //
    // Display driver configuration
    //
    if (LCD_GetSwapXY()) {
        LCD_SetSizeEx (0, YSIZE_PHYS, XSIZE_PHYS);
        LCD_SetVSizeEx(0, YSIZE_PHYS, XSIZE_PHYS);
    } else {
        LCD_SetSizeEx (0, XSIZE_PHYS, YSIZE_PHYS);
        LCD_SetVSizeEx(0, XSIZE_PHYS, YSIZE_PHYS);
    }
    //
    // Initialize VRAM access of the driver
    //
    LCD_SetVRAMAddrEx(0, (void *)&_VRAM_Desc);
}
```



## 11.7.2 GUIDRV\_DCACHE

GUIDRV\_DCACHE has been developed to minimize the communication between emWin and the display controller. It uses 2 caches to be able to check exactly which pixels have been changed between locking and unlocking the cache. When locking the cache the driver makes a copy of the current cache. When unlocking it, it checks exactly which pixels have been changed. Only the changed pixels will be send to the controller.

Using this double cache driver makes sense if the performance bottleneck is the communication between CPU and display controller.

The driver can not be used stand alone. It is required to use a 'real' display driver for the drawing operations.

GUIDRV\_DCACHE is part of the emWin basic package.

### 11.7.2.1 Supported hardware

The double cache driver is able to work with each runtime configurable display driver which works with 16bpp color format.

### 11.7.2.2 Driver selection

To be able to use this driver the following call has to be made:

```
pDevice = GUI_DEVICE_CreateAndLink(GUIDRV_DCACHE, GUICC_1, 0, Layer);
```

### 11.7.2.3 RAM requirements

As the drivers name implies it uses 2 caches. Currently only a color depth of 1bpp is supported by the driver. The RAM usage can be calculated as follows:

```
Size = 2 * (LCD_XSIZE + 7) / 8 * LCD_YSIZE
```

### 11.7.2.4 Run-time configuration

First the 'real' driver should be created and configured:

```
pDriver = GUI_DEVICE_Create(DISPLAY_DRIVER, GUICC_XXX, 0, Layer);
//
// Configuration of a real driver
//
.
.
.
```

GUICC\_XXX means any 16bpp color conversion scheme. After that the double cache driver can be created and configured:

```
//
// Create and configure (double) cache driver, ...
//
pDevice = GUI_DEVICE_CreateAndLink(GUIDRV_DCACHE, GUICC_1, 0, Layer);
//
// ... set size, ...
//
LCD_SetSizeEx (0, XSIZE_PHYS, YSIZE_PHYS);
LCD_SetVSizeEx(0, VXSIZE_PHYS, VYSIZE_PHYS);
//
// ...set color depth, ...
//
GUIDRV_DCACHE_SetModelbpp(pDevice);
```

Then the 'real' driver should be added for doing the drawing operations:

```
//  
// ... and add real driver.  
//  
GUIDRV_DCache_AddDriver(pDevice, pDriver);
```

### 11.7.2.5 Configuration API

| Routine                                     | Description   |
|---|---|
| <a href="#">GUIDRV_DCache_AddDriver()</a>   | Adds the 'real' driver to the DCache driver which is used for the drawing operations. |
| <a href="#">GUIDRV_DCache_SetModelbpp()</a> | Sets the 1bpp mode for the DCache driver.   |

### 11.7.2.5.1 GUIDRV\_DCache\_AddDriver()

#### Description

Adds the 'real' driver to the DCache driver which is used for the drawing operations.

#### Prototype

```
void GUIDRV_DCache_AddDriver(GUI_DEVICE * pDevice,  
                             GUI_DEVICE * pDriver);
```

#### Parameters

| Parameter            | Description                          |
|----------------------|--------------------------------------|
| <code>pDevice</code> | Pointer to the DCache driver device. |
| <code>pDriver</code> | Pointer to the real driver device.   |

#### Additional information

The used driver should work in 16bpp mode because the double cache driver currently only supports 16bpp output.

### 11.7.2.5.2 GUIDRV\_DCache\_SetMode1bpp()

#### Description

Sets the 1bpp mode for the DCache driver.

#### Prototype

```
void GUIDRV_DCache_SetMode1bpp(GUI_DEVICE * pDevice);
```

#### Parameters

| Parameter            | Description                          |
|----------------------|--------------------------------------|
| <code>pDevice</code> | Pointer to the DCache driver device. |

#### Additional information

Currently the DCache driver works only with a color depth of 1bpp.

## 11.7.3 GUIDRV\_Dist

GUIDRV\_Dist has been developed to support displays with multiple controllers. It is able to support multiple display areas each driven by a separate display controller. The distribution driver passes the drawing operations to the according display driver. This also works with overlapping operations. In these cases the operations are divided into sub operations for each affected controller. GUIDRV\_Dist is part of the emWin basic package.

### 11.7.3.1 Supported hardware

The distribution driver is able to work with each runtime configurable display driver. Please note that it is required that each of the configured display drivers use the same color conversion as the distribution driver.

### 11.7.3.2 Driver selection

To be able to use this driver the following call has to be made:

```
pDevice = GUI_DEVICE_CreateAndLink(GUIDRV_DIST, COLOR_CONVERSION, 0, Layer);
```

### 11.7.3.3 RAM requirements

None.

### 11.7.3.4 Run-time configuration

After the driver has been created the actual display drivers should be also created and added to the distribution device:

```
pDevice0 = GUI_DEVICE_Create(DISPLAY_DRIVER, COLOR_CONVERSION, 0, -1);  
pDevice1 = GUI_DEVICE_Create(DISPLAY_DRIVER, COLOR_CONVERSION, 0, -1);  
GUIDRV_Dist_AddDriver(pDevice, pDevice0, &Rect0);  
GUIDRV_Dist_AddDriver(pDevice, pDevice1, &Rect1);
```

### 11.7.3.5 GUIDRV\_Dist\_AddDriver()

#### Description

Adds a display driver to the distribution driver.

#### Prototype

```
void GUIDRV_Dist_AddDriver(GUI_DEVICE * pDevice,
                           GUI_DEVICE * pDriver,
                           GUI_RECT   * pRect);
```

#### Parameters

| Parameter            | Description  |
|----------------------|--|
| <code>pDevice</code> | Pointer to the already created distribution device.                  |
| <code>pDriver</code> | Pointer to the already created driver device to be added.            |
| <code>pRect</code>   | Pointer to the rectangle in which outputs have to affect the driver. |

#### Configuration example

```
void LCD_X_Config(void) {
    //
    // Set display driver and color conversion for 1st layer
    //
    pDevice = GUI_DEVICE_CreateAndLink(GUIDRV_DIST, COLOR_CONVERSION, 0, 0);
    //
    // Display size configuration
    //
    LCD_SetSizeEx (0, XSIZE_PHYS, YSIZE_PHYS);
    LCD_SetVSizeEx(0, VXSIZE_PHYS, VYSIZE_PHYS);
    //
    // Create first display driver
    //
    pDevice0 = GUI_DEVICE_Create(DISPLAY_DRIVER, COLOR_CONVERSION, 0, -1);
    //
    // Configuration of first driver
    //
    ...
    //
    // Create second display driver
    //
    pDevice1 = GUI_DEVICE_Create(DISPLAY_DRIVER, COLOR_CONVERSION, 0, -1);
    //
    // Configuration of second driver
    //
    ...
    //
    // Add display drivers to distribution driver
    //
    Rect0.x0 = 0;
    Rect0.y0 = 160;
    Rect0.x1 = 223;
    Rect0.y1 = 319;
    GUIDRV_Dist_AddDriver(pDevice, pDevice0, &Rect0);
    Rect1.x0 = 0;
    Rect1.y0 = 0;
    Rect1.x1 = 223;
    Rect1.y1 = 159;
    GUIDRV_Dist_AddDriver(pDevice, pDevice1, &Rect1);
}
```

## 11.7.4 GUIDRV\_FlexColor

### 11.7.4.1 Supported hardware

#### Controllers

The supported display controllers are listed in the description of the function *GUIDRV\_FlexColor\_SetFunc* on page 2975.

#### Bits per pixel

Supported color depth is 16, 18 and 24 bpp.

#### Interfaces

The driver supports 8-bit, 9-bit, 16-bit and 18-bit indirect interface.

### 11.7.4.2 Driver selection

To be able to use this driver the following call has to be made:

```
pDevice = GUI_DEVICE_CreateAndLink(GUIDRV_FLEXCOLOR, COLOR_CONVERSION, 0, Layer);
```

Detailed information about palette modes can be found in the chapter *Colors* on page 478.

### 11.7.4.3 Display data RAM organization

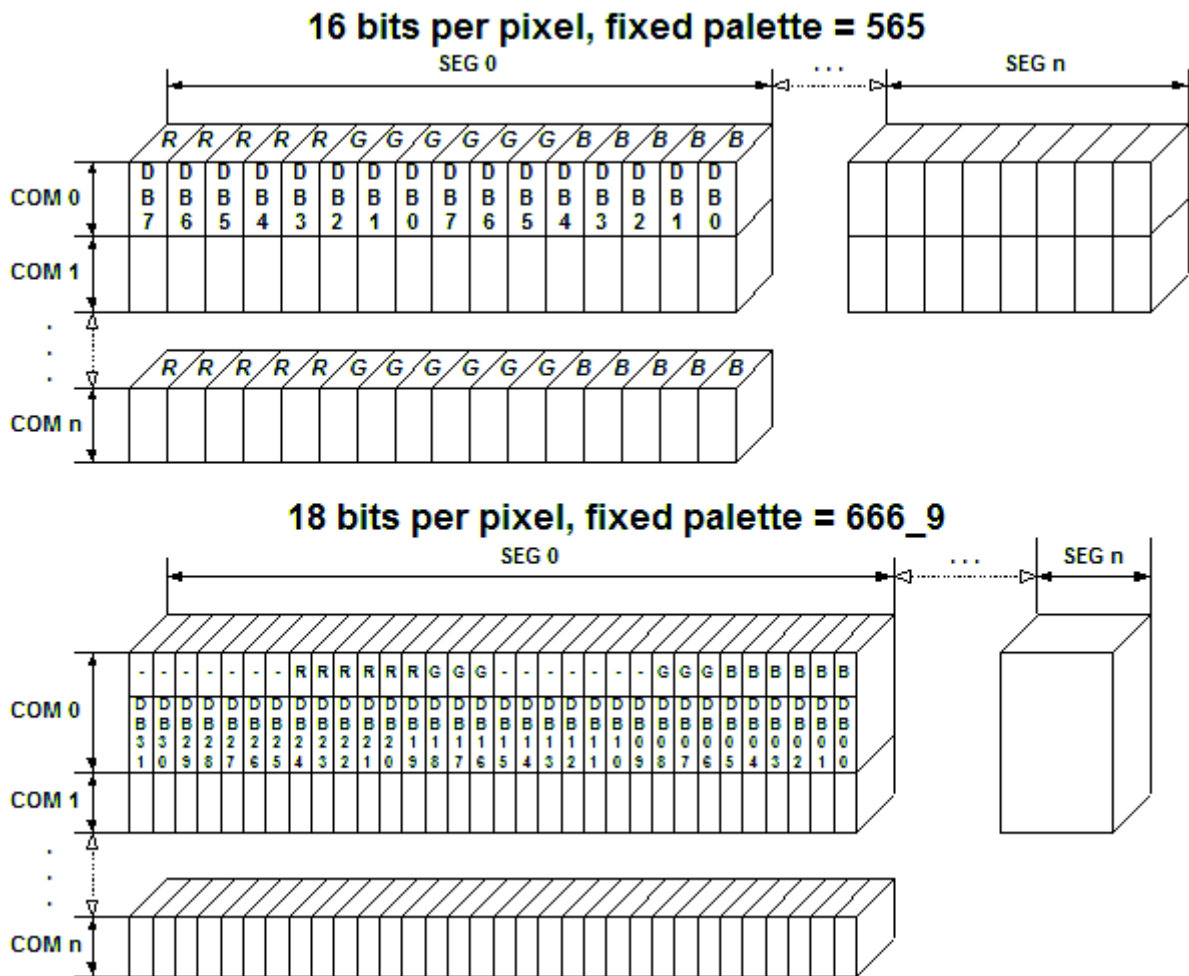

### 11.7.4.4 RAM requirements

This display driver requires approx. 500 Bytes to work and a line buffer. The size of the line buffer gets calculated as follow:

```
LCD_XSIZE * ((BitsPerPixel + 7) / 8)
```

It can also be used with and without a display data cache, containing a complete copy of the content of the display data RAM. The amount of memory used by the cache is:

```
LCD_XSIZE * LCD_YSIZE * BytesPerPixel
```

BytesPerPixel is 2 for 16bpp mode and 4 for 18bpp mode. Using a cache avoids reading operations from the display controller in case of XOR drawing operations and further it speeds up string output operations.

### 11.7.4.5 Run-time configuration API

The following table lists the available run-time configuration routines:

| Routine                          | Description   |
|----------------------------------|---|
| <a href="#">LCD_SetDevFunc()</a> | The function sets additional and / or user defined functions of the display driver. |

### 11.7.4.6 Commands supported by LCD\_SetDevFunc()

| Command                                 | Description  |
|---|--|
| <a href="#">LCD_DEVFUNC_READMPIXELS</a> | Can be used to set a custom defined routine for reading multiple pixels from the display controller. |
| <a href="#">LCD_DEVFUNC_READPIXEL</a>   | Can be used to set a custom defined routine for reading a single pixel from the display controller.  |

Further information about the LCD layer routines can be found under *Display driver API* on page 3100.

#### Important note on reading back pixel data from the controller

Because of the plurality of the supported display controllers and their operation modes the driver has not been tested with each interface of each supported controller. The behavior of the controller when reading back pixel data often depends on custom configuration and hardware details. Because of that it could happen, that the driver has no appropriate reading function(s) available. In that case the above explained function [LCD\\_SetDevFunc\(\)](#) can be used to set application defined functions for reading back pixel data.

The main problem for the driver here is not getting data from the driver. Getting the color bits in the right order is the problem here. The custom defined functions need to supply 'pixel index' values. This index format needs to comply to the index format determined by the color conversion routines configured for the driver device. Because the data supplied by the hardware interface functions of the driver in most cases does not have the right index format, the reading routines need to convert that raw data into the required pixel index format determined by the driver device configuration. For details about the hardware interface functions please also refer to [GUIDRV\\_FlexColor\\_SetFunc\(\)](#) and its parameter `pHW_API`. For details about the pixel index format please also refer to [GUI\\_DEVICE\\_CreateAndLink\(\)](#) and its parameter `pColorConvAPI` and the chapter *Colors* on page 478. A sample configuration which shows how custom reading functions can be achieved is available in the configuration file sample folder shipped with the driver.



### 11.7.4.7 Configuration API

| Routine   | Description  |
|---|--|
| Common configuration routines                         |  |
| <code>GUIDRV_FlexColor_SetFunc()</code>               | Configures bus, cache, and hardware routines.                |
| <code>GUIDRV_FlexColor_Config()</code>                | Configures orientation and offset of the SEG- and COM-lines. |
| <code>GUIDRV_FlexColor_SetOrientation()</code>        | Sets a new orientation for the given layer.                  |
| Detailed interface selection                          |  |
| <code>GUIDRV_FlexColor_SetInterface66712_B9()</code>  | Set up bus interface (TYPE_I, TYPE_II).                      |
| <code>GUIDRV_FlexColor_SetInterface66712_B18()</code> | Set up bus interface (TYPE_I, TYPE_II).                      |
| <code>GUIDRV_FlexColor_SetInterface66715_B9()</code>  | Set up bus interface (TYPE_I, TYPE_II).                      |
| <code>GUIDRV_FlexColor_SetInterface66715_B18()</code> | Set up bus interface (TYPE_I, TYPE_II).                      |
| Configuration of read back function                   |  |
| <code>GUIDRV_FlexColor_SetReadFunc66709_B16()</code>  | Read back function settings.                                 |
| <code>GUIDRV_FlexColor_SetReadFunc66712_B9()</code>   | Read back function settings.                                 |
| <code>GUIDRV_FlexColor_SetReadFunc66712_B16()</code>  | Read back function settings.                                 |
| <code>GUIDRV_FlexColor_SetReadFunc66715_B9()</code>   | Read back function settings.                                 |
| <code>GUIDRV_FlexColor_SetReadFunc66715_B16()</code>  | Read back function settings.                                 |
| <code>GUIDRV_FlexColor_SetReadFunc66720_B16()</code>  | Read back function settings.                                 |
| <code>GUIDRV_FlexColor_SetReadFunc66772_B8()</code>   | Read back function settings.                                 |
| <code>GUIDRV_FlexColor_SetReadFunc66772_B16()</code>  | Read back function settings.                                 |

The above set of configuration functions set up the detailed behavior of the driver. In short they do the following:

#### **GUIDRV\_FlexColor\_SetFunc()**

Configures the LCD-controller to be used, color depth and cache settings.

#### **GUIDRV\_FlexColor\_Config()**

Configures display orientation, dummy reads and first SEG- and COM-lines.

#### **GUIDRV\_FlexColor\_SetInterface()**

Configures the bus interface to be used.

#### **GUIDRV\_FlexColor\_SetReadFunc()**

Configures the behavior when reading back pixel data.

#### **Calling sequence**

The following shows a recommended sequence of configuration function calls:

```
GUI_DEVICE_CreateAndLink()
GUIDRV_FlexColor_Config()
LCD_SetSizeEx()
LCD_SetVSizeEx()
GUIDRV_FlexColor_SetInterface()
```

```
GUIDRV_FlexColor_SetReadFunc()  
GUIDRV_FlexColor_SetFunc()
```

### 11.7.4.7.1 GUIDRV\_FlexColor\_SetFunc()

#### Description

Configures bus width, cache usage and hardware routines.

#### Prototype

```
void GUIDRV_FlexColor_SetFunc(GUI_DEVICE * pDevice,
                              GUI_PORT_API * pHW_API,
                              void        ( *pfFunc)(GUI_DEVICE * ),
                              void        ( *pfMode)(GUI_DEVICE * ));
```

#### Parameters

| Parameter            | Description  |
|----------------------|--|
| <code>pDevice</code> | Pointer to the driver device structure.  |
| <code>pHW_API</code> | Pointer to a <code>GUI_PORT_API</code> structure. See required routines below. |
| <code>pfFunc</code>  | Controller selection macro. See table below.                                   |
| <code>pfMode</code>  | See table below.   |

| Permitted values for parameter <code>pfFunc</code><br>Supported display controller |   |
|--|---|
| <code>GUIDRV_FLEXCOLOR_F66702</code>   | Set up the driver to use one of the following controllers: <ul style="list-style-type: none"> <li>• Solomon SSD1284, SSD1289, SSD1298</li> </ul>  |
| <code>GUIDRV_FLEXCOLOR_F66708</code>   | Set up the driver to use one of the following controllers: <ul style="list-style-type: none"> <li>• FocalTech FT1509</li> <li>• Ilitek ILI9320, ILI9325, ILI9328, ILI9335</li> <li>• LG Electronics LGDP4531, LGDP4551</li> <li>• OriseTech SPFD5408</li> <li>• Renesas R61505, R61580</li> </ul>   |
| <code>GUIDRV_FLEXCOLOR_F66709</code>   | Set up the driver to use one of the following controllers: <ul style="list-style-type: none"> <li>• Epson S1D19122</li> <li>• Himax HX8353, HX8325A, HX8357, HX8369</li> <li>• Ilitek ILI9338, ILI9340, ILI9341, ILI9342, ILI9163, ILI9481, ILI9486, ILI9488, ILI9806H</li> <li>• Lucid Display Technology LDT7138</li> <li>• Novatek NT39122</li> <li>• Orisetech SPFD54124C, SPFD5414D</li> <li>• Renesas R61516, R61526</li> <li>• Sitronix ST7628, ST7637, ST7687, ST7715, ST7735, ST7789, ST7796</li> <li>• Solomon SSD1355</li> </ul> |
| <code>GUIDRV_FLEXCOLOR_F66712</code>   | Set up the driver to use one of the following controllers: <ul style="list-style-type: none"> <li>• Himax HX8340, HX8347, HX8352, HX8367</li> </ul>   |
| <code>GUIDRV_FLEXCOLOR_F66714</code>   | Set up the driver to use the following controller: <ul style="list-style-type: none"> <li>• Solomon SSD2119</li> </ul>  |
| <code>GUIDRV_FLEXCOLOR_F66715</code>   | Set up the driver to use one of the following controllers: <ul style="list-style-type: none"> <li>• Himax HX8352B</li> </ul>  |
| <code>GUIDRV_FLEXCOLOR_F66718</code>   | Set up the driver to use the following controller: <ul style="list-style-type: none"> <li>• Syncoam SEPS525</li> </ul>  |
| <code>GUIDRV_FLEXCOLOR_F66719</code>   | Set up the driver to use the following controller: <ul style="list-style-type: none"> <li>• Samsung S6E63D6</li> </ul>  |
| <code>GUIDRV_FLEXCOLOR_F66720</code>   | Set up the driver to use one of the following controllers: <ul style="list-style-type: none"> <li>• Solomon SSD1961, SSD1963</li> </ul>   |
| <code>GUIDRV_FLEXCOLOR_F66721</code>   | Set up the driver to use one of the following controller:   |

|                         |  |
|-------------------------|--|
|                         | <ul style="list-style-type: none"> <li>RAIO RA8870, RA8875</li> </ul>  |
| GUIDRV_FLEXCOLOR_F66722 | Set up the driver to use one of the following controller: <ul style="list-style-type: none"> <li>Solomon SSD1351, SSD1353</li> </ul>   |
| GUIDRV_FLEXCOLOR_F66723 | Set up the driver to use one of the following controller: <ul style="list-style-type: none"> <li>Lucid Display Technology LDT7138</li> </ul>   |
| GUIDRV_FLEXCOLOR_F66724 | Set up the driver to use one of the following controllers: <ul style="list-style-type: none"> <li>Sitronix ST7775</li> </ul>   |
| GUIDRV_FLEXCOLOR_F66725 | Set up the driver to use one of the following controllers: <ul style="list-style-type: none"> <li>UltraChip UC1698</li> </ul>  |
| GUIDRV_FLEXCOLOR_F66772 | Set up the driver to use one of the following controllers: <ul style="list-style-type: none"> <li>Himax HX8301</li> <li>Ilitek ILI9220, ILI9221</li> <li>LG Electronics LGDP4525</li> <li>Samsung S6D0117</li> <li>Sitronix ST7712</li> <li>Hitachi HD66772</li> </ul> |

The display controllers listed in the table above are the currently known controllers compatible to the driver. Please note that the used numbers of the selection macros are compatible to some of the LCD\_CONTROLLER macro of the driver GUIDRV\_CompactColor\_16. This makes it easy to migrate from the compile time configurable GUIDRV\_CompactColor\_16 to the runtime configurable GUIDRV\_FlexColor.

| Permitted values for parameter <code>pfMode</code> |                             |
|--|-----------------------------|
| GUIDRV_FLEXCOLOR_M16C0B8                           | 16bpp, no cache, 8 bit bus  |
| GUIDRV_FLEXCOLOR_M16C1B8                           | 16bpp, cache, 8 bit bus     |
| GUIDRV_FLEXCOLOR_M16C0B16                          | 16bpp, no cache, 16 bit bus |
| GUIDRV_FLEXCOLOR_M16C1B16                          | 16bpp, cache, 16 bit bus    |
| GUIDRV_FLEXCOLOR_M18C0B9                           | 18bpp, no cache, 9 bit bus  |
| GUIDRV_FLEXCOLOR_M18C1B9                           | 18bpp, cache, 9 bit bus     |
| GUIDRV_FLEXCOLOR_M18C0B18                          | 18bpp, no cache, 18 bit bus |
| GUIDRV_FLEXCOLOR_M18C1B18                          | 18bpp, cache, 18 bit bus    |
| GUIDRV_FLEXCOLOR_M24C0B8                           | 24bpp, no cache, 8 bit bus  |

Each controller selection supports different operation modes. The table below shows the supported modes for each controller:

| Selection macro         | M16C0B8 | M16C1B8 | M16C0B16 | M16C1B16 | M18C0B9 | M18C1B9 | M18C0B18 | M18C1B18 | M24C0B8 |
|-------------------------|---------|---------|----------|----------|---------|---------|----------|----------|---------|
| GUIDRV_FLEXCOLOR_F66702 | X       | X       | X        | X        | -       | -       | -        | -        | -       |
| GUIDRV_FLEXCOLOR_F66708 | X       | X       | X        | X        | -       | -       | -        | -        | -       |
| GUIDRV_FLEXCOLOR_F66709 | X       | X       | X        | X        | -       | -       | -        | -        | X       |
| GUIDRV_FLEXCOLOR_F66712 | X       | X       | X        | X        | X       | X       | X        | X        | -       |
| GUIDRV_FLEXCOLOR_F66714 | X       | X       | X        | X        | X       | X       | -        | -        | -       |
| GUIDRV_FLEXCOLOR_F66715 | X       | X       | X        | X        | X       | X       | X        | X        | -       |
| GUIDRV_FLEXCOLOR_F66718 | X       | X       | X        | X        | X       | X       | -        | -        | -       |
| GUIDRV_FLEXCOLOR_F66719 | X       | X       | X        | X        | -       | -       | -        | -        | -       |
| GUIDRV_FLEXCOLOR_F66720 | X       | X       | X        | X        | -       | -       | -        | -        | X       |
| GUIDRV_FLEXCOLOR_F66721 | X       | X       | X        | X        | -       | -       | -        | -        | -       |
| GUIDRV_FLEXCOLOR_F66722 | X       | X       | -        | -        | -       | -       | -        | -        | -       |

| Selection macro         | M16C0B8 | M16C1B8 | M16C0B16 | M16C1B16 | M18C0B9 | M18C1B9 | M18C0B18 | M18C1B18 | M24C0B8 |
|-------------------------|---------|---------|----------|----------|---------|---------|----------|----------|---------|
| GUIDRV_FLEXCOLOR_F66723 | X       | X       | -        | -        | -       | -       | -        | -        | -       |
| GUIDRV_FLEXCOLOR_F66724 | X       | X       | X        | X        | -       | -       | -        | -        | -       |
| GUIDRV_FLEXCOLOR_F66725 | X       | X       | -        | -        | -       | -       | -        | -        | -       |
| GUIDRV_FLEXCOLOR_F66772 | X       | X       | X        | X        | -       | -       | -        | -        | -       |

### Legend

|   |               |
|---|---------------|
| X | supported     |
| - | not supported |

#### 11.7.4.7.1.1 Required GUI\_PORT\_API routines

The required GUI\_PORT\_API routines depend on the used interface. If a cache is used the routines for reading data are unnecessary for each interface:

##### 8 bit interface

| Element                      | Data type                          |
|------------------------------|------------------------------------|
| <a href="#">pfWrite8_A0</a>  | void (*)(U8 Data)                  |
| <a href="#">pfWrite8_A1</a>  | void (*)(U8 Data)                  |
| <a href="#">pfWriteM8_A1</a> | void (*)(U8 * pData, int NumItems) |
| <a href="#">pfRead8_A1</a>   | U8 (*)(void)                       |
| <a href="#">pfReadM8_A1</a>  | void (*)(U8 * pData, int NumItems) |

##### 16 bit interface

| Element                       | Data type                           |
|-------------------------------|-------------------------------------|
| <a href="#">pfWrite16_A0</a>  | void (*)(U16 Data)                  |
| <a href="#">pfWrite16_A1</a>  | void (*)(U16 Data)                  |
| <a href="#">pfWriteM16_A1</a> | void (*)(U16 * pData, int NumItems) |
| <a href="#">pfRead16_A1</a>   | U16 (*)(void)                       |
| <a href="#">pfReadM16_A1</a>  | void (*)(U16 * pData, int NumItems) |

##### 18 bit interface

| Element                       | Data type                           |
|-------------------------------|-------------------------------------|
| <a href="#">pfWrite32_A0</a>  | void (*)(U32 Data)                  |
| <a href="#">pfWrite32_A1</a>  | void (*)(U32 Data)                  |
| <a href="#">pfWriteM32_A1</a> | void (*)(U32 * pData, int NumItems) |
| <a href="#">pfRead32_A1</a>   | U32 (*)(void)                       |
| <a href="#">pfReadM32_A1</a>  | void (*)(U32 * pData, int NumItems) |

##### 9 bit interface

The following describes the behavior of the 9 bit bus variant of the driver. When working with a 9 bit interface the display controller uses the lines D17-D10 or lines D7-D0 (8 bit) for accessing the command register and D17-D9 or D8-D0 (9 bit) for passing data. This means the lines D17-D9 or D8-D0 are connected to the interface lines of the CPU.

The driver passes 16 bit values to the hardware routines. In dependence of the selected driver interface (`TYPE_I` or `TYPE_II`) the bits 7-0 (`TYPE_I`) or the bits 8-1 (`TYPE_II`) already contain the right values to be passed to the controller. No further shift operation is required in the hardware routines.

To be able to process pixel data as fast as possible, the driver passes two 16 bit data values per pixel (0000000R RRRRRGGG and 0000000G GBBBBBBB) to the hardware routines. Only the first 9 bits contain pixel data. So nothing need to be shifted in the hardware routines. In case of using the 9 bit interface the driver requires 16 bit hardware routines for communicating with the controller.

| Element                    | Data type  | Description   |
|----------------------------|--|---|
| <code>pfWrite16_A0</code>  | <code>void (*)(U16 Data)</code>                  | Routine used to set up the index register. Dependent on used bus interface DB8-DB1 or DB7-DB0 are used. |
| <code>pfWrite16_A1</code>  | <code>void (*)(U16 Data)</code>                  | Routine used to pass register parameters. Dependent on used bus interface DB8-DB1 or DB7-DB0 are used.  |
| <code>pfWriteM16_A1</code> | <code>void (*)(U16 * pData, int NumItems)</code> | Data to be written (DB0-DB9)  |
| <code>pfReadM16_A1</code>  | <code>void (*)(U16 * pData, int NumItems)</code> | Data read (DB0-DB9)   |

#### 11.7.4.7.1.2 GUIDRV\_FLEXCOLOR\_F66721

In addition to the hardware interface functions described above, the driver requires the following functions in case it is configured for a 66721-type controller. These controllers require reading the controller status. According to the used interface these functions are:

##### 8 bit interface

| Element                 | Data type                  |
|-------------------------|----------------------------|
| <code>pfRead8_A0</code> | <code>U8 (*)(void);</code> |

##### 16 bit interface

| Element                  | Data type                   |
|--------------------------|-----------------------------|
| <code>pfRead16_A0</code> | <code>U16 (*)(void);</code> |

Further these controllers do not support setting the orientation by the driver using `GUI-DRV_FlexColor_Config()`. This needs to be done in the initialization by setting the Display Configuration Register `0x20` (DPCR) accordingly.

### 11.7.4.7.2 GUIDRV\_FlexColor\_Config()

#### Description

Configures orientation and offset of the SEG- and COM-lines.

#### Prototype

```
void GUIDRV_FlexColor_Config(GUI_DEVICE      * pDevice,
                             CONFIG_FLEXCOLOR * pConfig);
```

#### Parameters

| Parameter            | Description   |
|----------------------|---|
| <code>pDevice</code> | Pointer to the device to configure.   |
| <code>pConfig</code> | Pointer to a <code>CONFIG_FLEXCOLOR</code> structure. See element list below. |

#### Elements of structure `CONFIG_FLEXCOLOR`

| Data type | Element       | Description   |
|-----------|---------------|---|
| int       | FirstSEG      | First segment line.   |
| int       | FirstCOM      | First common line.  |
| int       | Orientation   | One or more "OR"-combined values of the values to be found under <i>Orientation flags</i> on page 2956.   |
| U16       | RegEntryMode  | Normally the display controller uses 3 bits of one register to define the required display orientation. Normally these are the bits ID0, ID1 and AM. To be able to control the content of the other bits the RegEntryMode element can be used. The driver combines this value with the required orientation bits during the initialization process. |
| int       | NumDummyReads | Defines the number of reading operations which have to be done until valid data can be retrieved. Please note that only values $\neq 0$ are accepted. If the controller does not need one or more dummy reads, -1 should be used here.  |

| Permitted values for parameter Orientation |                        |
|--|------------------------|
| GUI_MIRROR_X                               | Mirroring the X-axis   |
| GUI_MIRROR_Y                               | Mirroring the Y-axis   |
| GUI_SWAP_XY                                | Swapping X- and Y-axis |

### 11.7.4.7.3 GUIDRV\_FlexColor\_SetOrientation()

#### Description

Sets the orientation of the screen when using GUIDRV\_FlexColor.

#### Prototype

```
int GUIDRV_FlexColor_SetOrientation(int Orientation,  
                                   int LayerIndex);
```

#### Parameters

| Parameter   | Description   |
|-------------|---|
| Orientation | The orientation to be used.                               |
| LayerIndex  | The index of the layer the orientation should be set for. |



**11.7.4.7.4 GUIDRV\_FlexColor\_SetInterface66712\_B9()****11.7.4.7.5 GUIDRV\_FlexColor\_SetInterface66715\_B9()****Description**

Sets the type of interface to be used.

**Prototypes**

```
void GUIDRV_FlexColor_SetInterface66712_B9(GUI_DEVICE * pDevice,
                                           int          Type);

void GUIDRV_FlexColor_SetInterface66715_B9(GUI_DEVICE * pDevice,
                                           int          Type);
```

**Parameters**

| Parameter            | Description   |
|----------------------|---|
| <code>pDevice</code> | Pointer to the device to configure.                         |
| <code>Type</code>    | Type of the interface to be used. See possible types below. |

| Permitted values for parameter Type      |   |
|--|---|
| <code>GUIDRV_FLEXCOLOR_IF_TYPE_I</code>  | Uses lines DB7-DB0 for register access and lines DB8-DB0 for data access. (default) |
| <code>GUIDRV_FLEXCOLOR_IF_TYPE_II</code> | Uses lines DB8 to DB1 for register access and lines DB8-DB0 for data access.        |

**Additional information**

The difference between the interfaces affects the register access to the controller. Normally there are 2 kinds of possible interfaces available when working with the 18 bit bus interface. `TYPE_I` uses the lines D7 to D0 for register access whereas `TYPE_II` uses the lines D8 to D1.

**11.7.4.7.6 GUIDRV\_FlexColor\_SetInterface66712\_B18()****11.7.4.7.7 GUIDRV\_FlexColor\_SetInterface66715\_B18()****Description**

Sets the type of interface to be used.

**Prototypes**

```
void GUIDRV_FlexColor_SetInterface66712_B18(GUI_DEVICE * pDevice,
                                             int          Type);

void GUIDRV_FlexColor_SetInterface66715_B18(GUI_DEVICE * pDevice,
                                             int          Type);
```

**Parameters**

| Parameter            | Description   |
|----------------------|---|
| <code>pDevice</code> | Pointer to the device to configure.                         |
| <code>Type</code>    | Type of the interface to be used. See possible types below. |

| Permitted values for parameter Type      |   |
|--|---|
| <code>GUIDRV_FLEXCOLOR_IF_TYPE_I</code>  | Uses lines DB7-DB0 for register access and lines DB8-DB0 for data access. (default) |
| <code>GUIDRV_FLEXCOLOR_IF_TYPE_II</code> | Uses lines DB8 to DB1 for register access and lines DB8-DB0 for data access.        |

**Additional information**

The difference between the interfaces affects the register access to the controller. Normally there are 2 kinds of possible interfaces available when working with the 18 bit bus interface. `TYPE_I` uses the lines D7 to D0 for register access whereas `TYPE_II` uses the lines D8 to D1.

### 11.7.4.7.8 GUIDRV\_FlexColor\_SetReadFunc66709\_B16()

#### Description

Sets the function(s) to be used for reading back pixel data. To be called before `GUIDRV_FlexColor_SetFunc()`.

#### Prototype

```
void GUIDRV_FlexColor_SetReadFunc66709_B16(GUI_DEVICE * pDevice,
                                           int          Func);
```

#### Parameters

| Parameter            | Description   |
|----------------------|---|
| <code>pDevice</code> | Pointer to the device to configure.                         |
| <code>Func</code>    | Type of the interface to be used. See possible types below. |

| Permitted values for parameter <code>Func</code> |  |
|--|--|
| <code>GUIDRV_FLEXCOLOR_READ_FUNC_I</code>        | 3 cycles and data conversion required. (default) |
| <code>GUIDRV_FLEXCOLOR_READ_FUNC_II</code>       | 2 cycles and no conversion required.             |
| <code>GUIDRV_FLEXCOLOR_READ_FUNC_III</code>      | 3 cycles and data conversion required.           |

#### Additional information

The difference between the interfaces affects only reading back pixels. The right interface depends on the used controller.

#### GUIDRV\_FLEXCOLOR\_READ\_FUNC\_I

| Cycle | D15        | D14 | D13 | D12 | D11 | D10 | D9 | D8 | D7 | D6 | D5 | D4 | D3 | D2 | D1 | D0 |
|-------|------------|-----|-----|-----|-----|-----|----|----|----|----|----|----|----|----|----|----|
| 1st   | Dummy read |     |     |     |     |     |    |    |    |    |    |    |    |    |    |    |
| 2nd   | -          | -   | -   | -   | -   | -   | -  | -  | B4 | B3 | B2 | B1 | B0 | -  | -  | -  |
| 3rd   | G5         | G4  | G3  | G2  | G1  | G0  | -  | -  | R4 | R3 | R2 | R1 | R0 | -  | -  | -  |

In dependence of controller settings red and blue could be swapped.

#### GUIDRV\_FLEXCOLOR\_READ\_FUNC\_II

| Cycle | D15        | D14 | D13 | D12 | D11 | D10 | D9 | D8 | D7 | D6 | D5 | D4 | D3 | D2 | D1 | D0 |
|-------|------------|-----|-----|-----|-----|-----|----|----|----|----|----|----|----|----|----|----|
| 1st   | Dummy read |     |     |     |     |     |    |    |    |    |    |    |    |    |    |    |
| 2nd   | B4         | B3  | B2  | B1  | B0  | G5  | G4 | G3 | G2 | G1 | G0 | R4 | R3 | R2 | R1 | R0 |

In dependence of controller settings red and blue could be swapped.

**GUIDRV\_FLEXCOLOR\_READ\_FUNC\_III**

| Cycle | D15        | D14 | D13 | D12 | D11 | D10 | D9 | D8 | D7 | D6 | D5 | D4 | D3 | D2 | D1 | D0 |
|-------|------------|-----|-----|-----|-----|-----|----|----|----|----|----|----|----|----|----|----|
| 1st   | Dummy read |     |     |     |     |     |    |    |    |    |    |    |    |    |    |    |
| 2nd   | B4         | B3  | B2  | B1  | B0  | -   | -  | -  | G5 | G4 | G3 | G2 | G1 | G0 | -  | -  |
| 3rd   | R4         | R3  | R2  | R1  | R0  | -   | -  | -  | -  | -  | -  | -  | -  | -  | -  | -  |

In dependence of controller settings red and blue could be swapped.

### 11.7.4.7.9 GUIDRV\_FlexColor\_SetReadFunc66712\_B9()

### 11.7.4.7.10 GUIDRV\_FlexColor\_SetReadFunc66715\_B9()

#### Description

Sets the function(s) to be used for reading back pixel data. To be called before `GUIDRV_FlexColor_SetFunc()`.

#### Prototypes

```
void GUIDRV_FlexColor_SetReadFunc66712_B9(GUI_DEVICE * pDevice,
                                           int          Func);
```

```
void GUIDRV_FlexColor_SetReadFunc66715_B9(GUI_DEVICE * pDevice,
                                           int          Func);
```

#### Parameters

| Parameter            | Description   |
|----------------------|---|
| <code>pDevice</code> | Pointer to the device to configure.                         |
| <code>Type</code>    | Type of the interface to be used. See possible types below. |

| Permitted values for parameter Func        |  |
|--|--|
| <code>GUIDRV_FLEXCOLOR_READ_FUNC_I</code>  | 3 cycles and data conversion required. (default) |
| <code>GUIDRV_FLEXCOLOR_READ_FUNC_II</code> | 3 cycles and data conversion required.           |

#### Additional information

The right function to be used depends on the behavior of the used controller.

#### GUIDRV\_FLEXCOLOR\_READ\_FUNC\_I

| Cycle | D15        | D14 | D13 | D12 | D11 | D10 | D9 | D8 | D7 | D6 | D5 | D4 | D3 | D2 | D1 | D0 |
|-------|------------|-----|-----|-----|-----|-----|----|----|----|----|----|----|----|----|----|----|
| 1st   | Dummy read |     |     |     |     |     |    |    |    |    |    |    |    |    |    |    |
| 2nd   | -          | -   | -   | -   | -   | -   | -  | B5 | B4 | B3 | B2 | B1 | B0 | G5 | G4 | G3 |
| 3rd   | -          | -   | -   | -   | -   | -   | -  | G2 | G1 | G0 | R5 | R4 | R3 | R2 | R1 | R0 |

In dependence of controller settings red and blue could be swapped.

#### GUIDRV\_FLEXCOLOR\_READ\_FUNC\_II

| Cycle | D15        | D14 | D13 | D12 | D11 | D10 | D9 | D8 | D7 | D6 | D5 | D4 | D3 | D2 | D1 | D0 |
|-------|------------|-----|-----|-----|-----|-----|----|----|----|----|----|----|----|----|----|----|
| 1st   | Dummy read |     |     |     |     |     |    |    |    |    |    |    |    |    |    |    |
| 2nd   | B5         | B4  | B3  | B2  | B1  | B0  | -  | -  | G5 | G4 | G3 | G2 | G1 | G0 | -  | -  |
| 3rd   | R5         | R4  | R3  | R2  | R1  | R0  | -  | -  | -  | -  | -  | -  | -  | -  | -  | -  |

In dependence of controller settings red and blue could be swapped.

**11.7.4.7.11 GUIDRV\_FlexColor\_SetReadFunc66712\_B16()****11.7.4.7.12 GUIDRV\_FlexColor\_SetReadFunc66715\_B16()****Description**

Sets the function(s) to be used for reading back pixel data. To be called before `GUIDRV_FlexColor_SetFunc()`.

**Prototype**

```
void GUIDRV_FlexColor_SetReadFunc66712_B16(GUI_DEVICE * pDevice,
                                           int          Func);
```

```
void GUIDRV_FlexColor_SetReadFunc66715_B16(GUI_DEVICE * pDevice,
                                           int          Func);
```

**Parameters**

| Parameter            | Description   |
|----------------------|---|
| <code>pDevice</code> | Pointer to the device to configure.                         |
| <code>Type</code>    | Type of the interface to be used. See possible types below. |

**Permitted values for parameter Func**

|   |  |
|---|--|
| <code>GUIDRV_FLEXCOLOR_READ_FUNC_I</code>   | 4 cycles and data conversion required. (default) |
| <code>GUIDRV_FLEXCOLOR_READ_FUNC_II</code>  | 4 cycles and data conversion required.           |
| <code>GUIDRV_FLEXCOLOR_READ_FUNC_III</code> | 3 cycles and data conversion required.           |

**Additional information**

The right function to be used depends on the behavior of the used controller.

**GUIDRV\_FLEXCOLOR\_READ\_FUNC\_I**

| Cycle | D15        | D14 | D13 | D12 | D11 | D10 | D9 | D8 | D7 | D6 | D5 | D4 | D3 | D2 | D1 | D0 |
|-------|------------|-----|-----|-----|-----|-----|----|----|----|----|----|----|----|----|----|----|
| 1st   | Dummy read |     |     |     |     |     |    |    |    |    |    |    |    |    |    |    |
| 2nd   | -          | -   | -   | -   | -   | -   | -  | -  | B4 | B3 | B2 | B1 | B0 | -  | -  | -  |
| 3rd   | -          | -   | -   | -   | -   | -   | -  | -  | G5 | G4 | G3 | G2 | G1 | G0 | -  | -  |
| 4th   | -          | -   | -   | -   | -   | -   | -  | -  | R4 | R3 | R2 | R1 | R0 | -  | -  | -  |

In dependence of controller settings red and blue could be swapped.

**GUIDRV\_FLEXCOLOR\_READ\_FUNC\_II**

| Cycle | D15        | D14 | D13 | D12 | D11 | D10 | D9 | D8 | D7 | D6 | D5 | D4 | D3 | D2 | D1 | D0 |
|-------|------------|-----|-----|-----|-----|-----|----|----|----|----|----|----|----|----|----|----|
| 1st   | Dummy read |     |     |     |     |     |    |    |    |    |    |    |    |    |    |    |
| 2nd   | -          | -   | -   | -   | -   | -   | -  | -  | G5 | G4 | G3 | G2 | G1 | G0 | -  | -  |
| 3rd   | -          | -   | -   | -   | -   | -   | -  | -  | B4 | B3 | B2 | B1 | B0 | -  | -  | -  |

| Cycle | D15 | D14 | D13 | D12 | D11 | D10 | D9 | D8 | D7 | D6 | D5 | D4 | D3 | D2 | D1 | D0 |
|-------|-----|-----|-----|-----|-----|-----|----|----|----|----|----|----|----|----|----|----|
| 4th   | -   | -   | -   | -   | -   | -   | -  | -  | R4 | R3 | R2 | R1 | R0 | -  | -  | -  |

In dependence of controller settings red and blue could be swapped.

### **GUIDRV\_FLEXCOLOR\_READ\_FUNC\_III**

| Cycle | D15        | D14 | D13 | D12 | D11 | D10 | D9 | D8 | D7 | D6 | D5 | D4 | D3 | D2 | D1 | D0 |
|-------|------------|-----|-----|-----|-----|-----|----|----|----|----|----|----|----|----|----|----|
| 1st   | Dummy read |     |     |     |     |     |    |    |    |    |    |    |    |    |    |    |
| 2nd   | B4         | B3  | B2  | B1  | B0  | -   | -  | -  | G5 | G4 | G3 | G2 | G1 | G0 | -  | -  |
| 3rd   | R4         | R3  | R2  | R1  | R0  | -   | -  | -  | -  | -  | -  | -  | -  | -  | -  | -  |

In dependence of controller settings red and blue could be swapped.

### 11.7.4.7.13 GUIDRV\_FlexColor\_SetReadFunc66720\_B16()

#### Description

Sets the function(s) to be used for reading back pixel data. To be called before `GUIDRV_FlexColor_SetFunc()`.

#### Prototype

```
void GUIDRV_FlexColor_SetReadFunc66720_B16(GUI_DEVICE * pDevice,
                                           int          Func);
```

#### Parameters

| Parameter            | Description  |
|----------------------|--|
| <code>pDevice</code> | Pointer to the device to configure.                                      |
| <code>Type</code>    | <code>Type</code> of the interface to be used. See possible types below. |

| Permitted values for parameter Func        |  |
|--|--|
| <code>GUIDRV_FLEXCOLOR_READ_FUNC_I</code>  | 3 cycles and data conversion required. (default) |
| <code>GUIDRV_FLEXCOLOR_READ_FUNC_II</code> | 2 cycles and no conversion required.             |

#### Additional information

The right function to be used depends on the behavior of the used controller. Whereas `...FUNC_I` extracts the index value by assembling it from the second and third word received from the controller, `...FUNC_II` uses the second word as it is. Please note that the right interface depends on the behavior of the used controller.

#### GUIDRV\_FLEXCOLOR\_READ\_FUNC\_I

| Cycle | D15        | D14 | D13 | D12 | D11 | D10 | D9 | D8 | D7 | D6 | D5 | D4 | D3 | D2 | D1 | D0 |
|-------|------------|-----|-----|-----|-----|-----|----|----|----|----|----|----|----|----|----|----|
| 1st   | Dummy read |     |     |     |     |     |    |    |    |    |    |    |    |    |    |    |
| 2nd   | -          | -   | -   | -   | -   | -   | -  | -  | B4 | B3 | B2 | B1 | B0 | -  | -  | -  |
| 3rd   | G5         | G4  | G3  | G2  | G1  | G0  | -  | -  | R4 | R3 | R2 | R1 | R0 | -  | -  | -  |

In dependence of controller settings red and blue could be swapped.

#### GUIDRV\_FLEXCOLOR\_READ\_FUNC\_II

| Cycle | D15        | D14 | D13 | D12 | D11 | D10 | D9 | D8 | D7 | D6 | D5 | D4 | D3 | D2 | D1 | D0 |
|-------|------------|-----|-----|-----|-----|-----|----|----|----|----|----|----|----|----|----|----|
| 1st   | Dummy read |     |     |     |     |     |    |    |    |    |    |    |    |    |    |    |
| 2nd   | B4         | B3  | B2  | B1  | B0  | G5  | G4 | G3 | G2 | G1 | G0 | R4 | R3 | R2 | R1 | R0 |

In dependence of controller settings red and blue could be swapped.



### 11.7.4.7.14 GUIDRV\_FlexColor\_SetReadFunc66772\_B8()

#### Description

Sets the function(s) to be used for reading back pixel data. To be called before `GUIDRV_FlexColor_SetFunc()`.

#### Prototype

```
void GUIDRV_FlexColor_SetReadFunc66772_B8(GUI_DEVICE * pDevice,
                                           int          Func);
```

#### Parameters

| Parameter                                  | Description  |
|--|--|
| <code>pDevice</code>                       | Pointer to the device to configure.                                      |
| <code>Type</code>                          | <code>Type</code> of the interface to be used. See possible types below. |
| Permitted values for parameter Func        |  |
| <code>GUIDRV_FLEXCOLOR_READ_FUNC_I</code>  | 3 cycles and no conversion required. (default)                           |
| <code>GUIDRV_FLEXCOLOR_READ_FUNC_II</code> | 3 cycles and conversion required.  |

#### Additional information

The right function to be used depends on the behavior of the used controller. Whereas `...FUNC_I` extracts the index value by assembling it from the second and third word received from the controller, `...FUNC_II` uses the second word as it is. Please note that the right interface depends on the behavior of the used controller.

#### GUIDRV\_FLEXCOLOR\_READ\_FUNC\_I

| Cycle | D7         | D6 | D5 | D4 | D3 | D2 | D1 | D0 |
|-------|------------|----|----|----|----|----|----|----|
| 1st   | Dummy read |    |    |    |    |    |    |    |
| 2nd   | B4         | B3 | B2 | B1 | B0 | G5 | G4 | G3 |
| 3rd   | G2         | G1 | G0 | R4 | R3 | R2 | R1 | R0 |

In dependence of controller settings red and blue could be swapped.

#### GUIDRV\_FLEXCOLOR\_READ\_FUNC\_II

| Cycle | D7         | D6 | D5 | D4 | D3 | D2 | D1 | D0 |
|-------|------------|----|----|----|----|----|----|----|
| 1st   | Dummy read |    |    |    |    |    |    |    |
| 2nd   | R4         | R3 | R2 | R1 | R0 | G5 | G4 | G3 |
| 3rd   | G2         | G1 | G0 | B4 | B3 | B2 | B1 | B0 |

In dependence of controller settings red and blue could be swapped.

### 11.7.4.7.15 GUIDRV\_FlexColor\_SetReadFunc66772\_B16()

#### Description

Sets the function(s) to be used for reading back pixel data. To be called before GUI-DRV\_FlexColor\_SetFunc().

#### Prototype

```
void GUIDRV_FlexColor_SetReadFunc66772_B16(GUI_DEVICE * pDevice,
                                           int          Func);
```

#### Parameters

| Parameter                           | Description   |
|-------------------------------------|---|
| pDevice                             | Pointer to the device to configure.                         |
| Type                                | Type of the interface to be used. See possible types below. |
| Permitted values for parameter Func |   |
| GUIDRV_FLEXCOLOR_READ_FUNC_I        | 2 cycles and no conversion required. (default)              |
| GUIDRV_FLEXCOLOR_READ_FUNC_II       | 2 cycles and conversion required.                           |

#### Additional information

The right function to be used depends on the behavior of the used controller. Whereas ...\_FUNC\_I extracts the index value by assembling it from the second and third word received from the controller, ...\_FUNC\_II uses the second word as it is. Please note that the right interface depends on the behavior of the used controller.

#### GUIDRV\_FLEXCOLOR\_READ\_FUNC\_I

| Cycle | D15        | D14 | D13 | D12 | D11 | D10 | D9 | D8 | D7 | D6 | D5 | D4 | D3 | D2 | D1 | D0 |
|-------|------------|-----|-----|-----|-----|-----|----|----|----|----|----|----|----|----|----|----|
| 1st   | Dummy read |     |     |     |     |     |    |    |    |    |    |    |    |    |    |    |
| 2nd   | B4         | B3  | B2  | B1  | B0  | G5  | G4 | G3 | G2 | G1 | G0 | R4 | R3 | R2 | R1 | R0 |

#### GUIDRV\_FLEXCOLOR\_READ\_FUNC\_II

| Cycle | D15        | D14 | D13 | D12 | D11 | D10 | D9 | D8 | D7 | D6 | D5 | D4 | D3 | D2 | D1 | D0 |
|-------|------------|-----|-----|-----|-----|-----|----|----|----|----|----|----|----|----|----|----|
| 1st   | Dummy read |     |     |     |     |     |    |    |    |    |    |    |    |    |    |    |
| 2nd   | R4         | R3  | R2  | R1  | R0  | G5  | G4 | G3 | G2 | G1 | G0 | B4 | B3 | B2 | B1 | B0 |

In dependence of controller settings red and blue can be swapped.

## 11.7.5 GUIDRV\_IST3088

### 11.7.5.1 Supported hardware

#### Controllers

This driver works with the following display controllers:

- Integrated Solutions Technology IST3088, IST3257

#### Bits per pixel

The supported color depth is 4 bpp.

#### Interfaces

The driver supports the 16-bit indirect interface.

### 11.7.5.2 Driver selection

To use GUIDRV\_IST3088 for the given display, the following command should be used:

```
pDevice = GUI_DEVICE_CreateAndLink(GUI_DRV_IST3088_4, GUI_CC_4, 0, 0);
```

### 11.7.5.3 Display data RAM organization

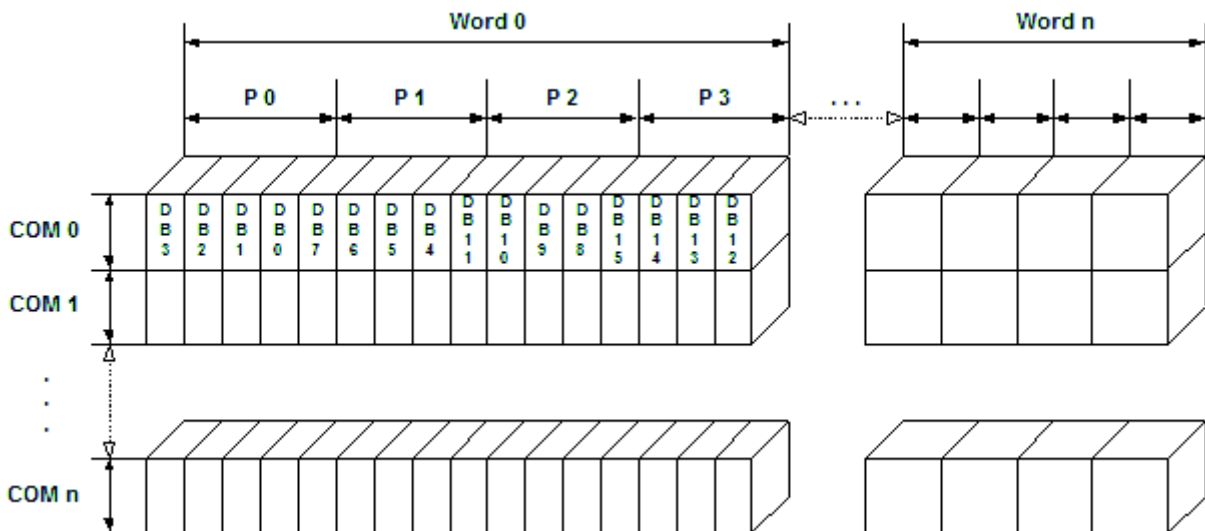

The delineation above shows the relation between the display memory and the SEG and COM lines of the LCD.

### 11.7.5.4 RAM requirements

This display driver can be used with and without a display data cache, containing a complete copy of the content of the display data RAM. The amount of memory (in bytes) used by the cache is:

```
LCD_XSIZE * LCD_YSIZE / 2.
```

### 11.7.5.5 Run-time configuration

The table below shows the available run-time configuration routines of this driver:

| Routine                                | Description   |
|--|---|
| <code>GUIDRV_IST3088_SetBus16()</code> | Tells the driver to use the 16 bit indirect interface and passes a pointer to a <code>GUI_PORT_API</code> structure to the driver containing function pointers to the hardware routines to be used. |

### 11.7.5.5.1 GUIDRV\_IST3088\_SetBus16()

#### Description

Tells the driver to use the 16 bit indirect interface and passes a pointer to a GUI\_PORT\_API structure to the driver containing function pointers to the hardware routines to be used.

#### Prototype

```
void GUIDRV_IST3088_SetBus16(GUI_DEVICE * pDevice,
                             GUI_PORT_API * pHW_API);
```

#### Parameters

| Parameter               | Description   |
|-------------------------|---|
| <a href="#">pDevice</a> | Pointer to the driver device.                                     |
| <a href="#">pHW_API</a> | Pointer to a GUI_PORT_API structure. See required routines below. |

### 11.7.5.6 Required GUI\_PORT\_API routines

| Element                       | Data types                          |
|-------------------------------|-------------------------------------|
| <a href="#">pfWrite16_A0</a>  | void (*)(U16 Data)                  |
| <a href="#">pfWrite16_A1</a>  | void (*)(U16 Data)                  |
| <a href="#">pfWriteM16_A1</a> | void (*)(U16 * pData, int NumItems) |

### 11.7.5.7 Special requirements

The driver needs to work in the fixed palette mode GUICC\_4. The driver does not work with other palettes or fixed palette modes. You should use GUICC\_4 as color conversion.

## 11.7.6 GUIDRV\_Lin

This driver supports all display controllers with linear video memory accessible via direct interface. It can be used with and without a display controller. The driver does only manage the contents of the video memory. It does not send any commands to the display controller or assumes any specific registers. So it is independent of the register interface of the display controller and can be used for managing each linear mapped video memory.

### 11.7.6.1 Supported hardware

#### Controllers

The driver supports all systems with linear mapped video memory.

#### Bits per pixel

Supported color depths are 1, 2, 4, 8, 16, 24 and 32 bits per pixel.

#### Interfaces

The driver supports a full bus interface from the CPU to the video memory. The video memory needs to be accessible 8, 16 or 32 bit wise.

### 11.7.6.2 Color depth and display orientation

The driver consists of several files. They are named `_[O]_[BPP].c`. where the optional `O` stands for the desired display orientation and `BPP` for the color depth. The following table shows configuration macros which should be used for selecting the desired driver orientation during the initialization:

| Identifier        | Color depth and orientation             |
|-------------------|---|
| GUIDRV_LIN_1      | 1bpp, default orientation               |
| GUIDRV_LIN_2      | 2bpp, default orientation               |
| GUIDRV_LIN_4      | 4bpp, default orientation               |
| GUIDRV_LIN_8      | 8bpp, default orientation               |
| GUIDRV_LIN_OX_8   | 8bpp, X axis mirrored                   |
| GUIDRV_LIN_OXY_8  | 8bpp, X and Y axis mirrored             |
| GUIDRV_LIN_16     | 16bpp, default orientation              |
| GUIDRV_LIN_OX_16  | 16bpp, X axis mirrored                  |
| GUIDRV_LIN_OXY_16 | 16bpp, X and Y axis mirrored            |
| GUIDRV_LIN_OY_16  | 16bpp, Y axis mirrored                  |
| GUIDRV_LIN_OS_16  | 16bpp, X and Y swapped                  |
| GUIDRV_LIN_OSX_16 | 16bpp, X axis mirrored, X and Y swapped |
| GUIDRV_LIN_OSY_16 | 16bpp, Y axis mirrored, X and Y swapped |
| GUIDRV_LIN_24     | 24bpp, default orientation              |
| GUIDRV_LIN_OX_24  | 24bpp, X axis mirrored                  |
| GUIDRV_LIN_OXY_24 | 24bpp, X and Y axis mirrored            |
| GUIDRV_LIN_OY_24  | 24bpp, Y axis mirrored                  |
| GUIDRV_LIN_OS_24  | 24bpp, X and Y swapped                  |
| GUIDRV_LIN_OSX_24 | 24bpp, X axis mirrored, X and Y swapped |
| GUIDRV_LIN_OSY_24 | 24bpp, Y axis mirrored, X and Y swapped |
| GUIDRV_LIN_32     | 32bpp, default orientation              |
| GUIDRV_LIN_OX_32  | 32bpp, X axis mirrored                  |

| Identifier        | Color depth and orientation             |
|-------------------|---|
| GUIDRV_LIN_OXY_32 | 32bpp, X and Y axis mirrored            |
| GUIDRV_LIN_OY_32  | 32bpp, Y axis mirrored                  |
| GUIDRV_LIN_OS_32  | 32bpp, X and Y swapped                  |
| GUIDRV_LIN_OSX_32 | 32bpp, X axis mirrored, X and Y swapped |
| GUIDRV_LIN_OSY_32 | 32bpp, Y axis mirrored, X and Y swapped |

The table above shows identifiers which can be used to select the driver. Each combination of orientation and color depth is possible. Please note that currently not all combinations are shipped with the driver. If the required combination is not available, please send a request to obtain the required combination.

### 11.7.6.3 Driver selection

To use for the given display, the following command can be used e.g.:

```
pDevice = GUI_DEVICE_CreateAndLink(GUIDRV_LIN_OX_16, GUICC_565, 0, 0);
```

Detailed information about palette modes can be found in the chapter *Colors* on page 478.

### 11.7.6.4 Display data RAM organization

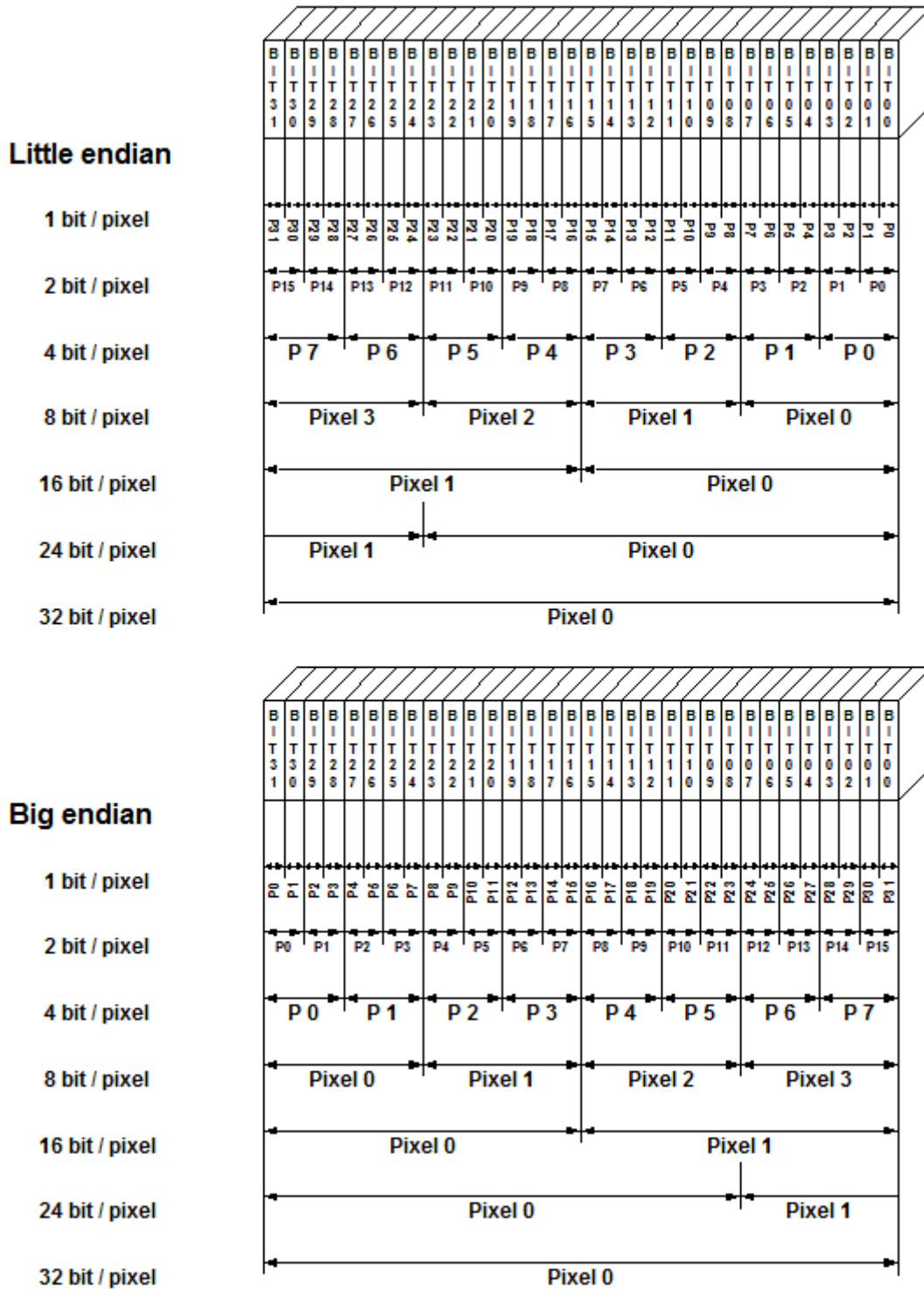

The picture above shows the relation between the display memory and the pixels of the LCD in terms of the color depth and the endian mode.

#### Little endian video mode

Least significant bits are used and output first. The least significant bits are for the first (left-most) pixel.

#### Big endian video mode

Most significant bits are used and output first. The most significant bits are for the first (left-most) pixel.



### 11.7.6.5 RAM requirements

None.

### 11.7.6.6 Compile-time configuration

The following table lists the macros which must be defined for hardware access:

| Macro                       | Description   |
|-----------------------------|---|
| <code>LCD_ENDIAN_BIG</code> | Should be set to 1 for big endian mode, 0 (default) for little endian mode. |

### 11.7.6.7 Run-time configuration

The following table lists the available run-time configuration routines:

| Routine                          | Description   |
|----------------------------------|---|
| <code>LCD_SetDevFunc()</code>    | The function sets additional and / or user defined functions of the display driver. |
| <code>LCD_SetSizeEx()</code>     | Sets the physical size of the visible area of the given display/layer.              |
| <code>LCD_SetVRAMAddrEx()</code> | Sets the address of the video RAM.  |
| <code>LCD_SetVSizeEx()</code>    | Sets the size of the virtual display area.  |

### 11.7.6.8 Commands supported by LCD\_SetDevFunc()

The following table shows the supported values of the function:

| Value                                  | Description   |
|--|---|
| <code>LCD_DEVFUNC_COPYBUFFER</code>    | Can be used to set a custom defined routine for copying buffers. Makes only sense in combination with multiple buffers.                               |
| <code>LCD_DEVFUNC_COPYRECT</code>      | Can be used to set a custom defined routine for copying rectangular areas of the display.   |
| <code>LCD_DEVFUNC_DRAWBMP_1BPP</code>  | Can be used to set a custom routine for drawing 1bpp bitmaps.   |
| <code>LCD_DEVFUNC_DRAWBMP_8BPP</code>  | Can be used to set a custom routine for drawing 8bpp bitmaps.   |
| <code>LCD_DEVFUNC_DRAWBMP_32BPP</code> | Can be used to set a custom routine for drawing 32bpp bitmaps.  |
| <code>LCD_DEVFUNC_FILLRECT</code>      | Can be used to set a custom defined routine for filling rectangles. Makes sense if for example a BitBLT engine should be used for filling operations. |

Further information about the LCD layer routines can be found under *Display driver API* on page 3100.

### 11.7.6.9 Configuration example

The following shows how to create a display driver device with this driver and how to configure it:

```
void LCD_X_Config(void) {
    //
    // Set display driver and color conversion
    //
    GUI_DEVICE_CreateAndLink(GUIDRV_LIN_8,    // Display driver
                            GUICC_8666,     // Color conversion
    }
```

```
        0, 0);  
//  
// Display driver configuration  
//  
LCD_SetSizeEx    (0, 320, 240); // Physical display size in pixels  
LCD_SetVSizeEx  (0, 320, 480); // Virtual display size in pixels  
LCD_SetVRAMAddrEx(0, (void *)0x20000000); // Video RAM start address  
}
```

### 11.7.6.10 Using the Lin driver in systems with cache memory

The rules to follow are quite simple:

#### Rule 1

All caches (if applicable, as in your case) should be fully enabled. This means I- and D-caches in systems with separate caches.

#### Rule 2

All code and data should be placed in cacheable areas to achieve maximum performance. If other parts of the application require some or all data to be placed in non-cacheable areas, this is not a problem but may degrade performance.

#### Rule 3

The cache settings for the frame buffer memory (which is really a shared memory area, accessed by both the CPU and the LCD-controller DMA) should make sure, that write operations are 'write-through' operations. The physical memory should be always up to date, so that the DMA-access of the LCD-controller always get the current content of the frame buffer. In case of a 'write-back' cache a write operation only changes the content of the cache, which is written to the physical memory not before the cache location is superseded. In many systems with MMU, this can be achieved by mapping the RAM twice into the virtual address space: At its normal address, the RAM is cacheable and bufferable, at the second address, it is cacheable but not bufferable. The address of the VRAM given to the driver should be the non bufferable address.

#### 'write-through' cache not available

If the CPU does not support a 'write-through' cache please refer to chapter *Framebuffer located in data cache area of CPU* on page 157. It explains how multiple buffering and a cache clearance function can be used.

## 11.7.7 GUIDRV\_S1D13L04

## 11.7.8 GUIDRV\_S1D13513

### Note

From a technical point of view both drivers are identically.

- <DRV> = 'L04': GUIDRV\_S1D13L04
- <DRV> = '513': GUIDRV\_S1D13513

### 11.7.8.1 Supported hardware

#### Controllers

This driver supports the Epson S1D13<DRV> only.

#### Bits per pixel

The supported color depth is 24 (Main and PIP1 layer) and 32 bpp (PIP2 layer).

#### Interfaces

The driver supports the 16-bit indirect interface only.

### 11.7.8.2 Driver selection

To use GUIDRV\_S1D13<DRV> the following command should be used:

```
pDevice = GUI_DEVICE_CreateAndLink(GUIDRV_S1D13<DRV>_32, GUICC_M888, 0, 0);
```

The `Sample` folder contains a configuration sample which shows in detail how to configure the driver.

### 11.7.8.3 Display data RAM organization

#### 24 bits per pixel, fixed palette = M888 (MAIN and PIP1)

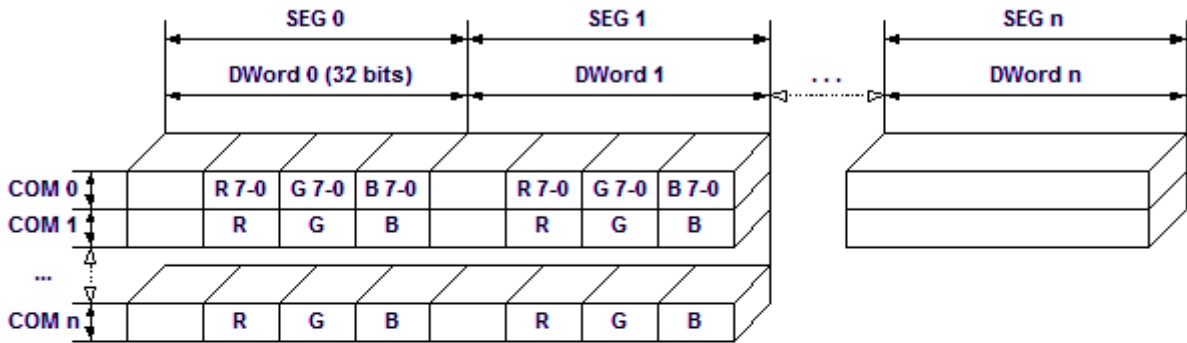

#### 32 bits per pixel, fixed palette = M8888I (PIP2)

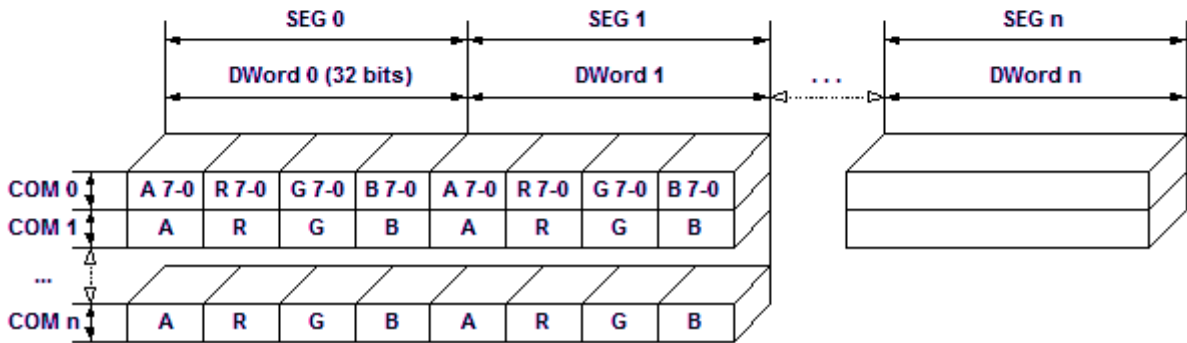

Relationship between memory and the SEG and COM lines.

### 11.7.8.4 RAM requirements

Approximately 2 KB.

### 11.7.8.5 Basic function

The driver uses the indirect interface mode of the S1D13<DRV>. It uses 3 registers for accessing the controller:

- Index register, tells the controller which SFR should be accessed.
- Status register, used to get the busy status of the controller.
- Data register for writing/reading data to/from SFRs/frame buffer.

### 11.7.8.6 Run-time configuration

The table below shows the available run-time configuration routines of this driver:

| Routine  | Description  |
|--|--|
| <a href="#">GUIDRV_S1D13L04_Config()</a><br><a href="#">GUIDRV_S1D13513_Config()</a>     | Passes a pointer to a CONFIG_S1D13<DRV> structure to the driver.   |
| <a href="#">GUIDRV_S1D13L04_SetBus16()</a><br><a href="#">GUIDRV_S1D13513_SetBus16()</a> | Configures the driver to use the 16 bit indirect interface by passing a pointer to a GUI_PORT_API structure. |

**11.7.8.6.1 GUIDRV\_S1D13L04\_Config()****11.7.8.6.2 GUIDRV\_S1D13513\_Config()****Description**

Configures the driver to work according to the passed CONFIG\_S1D13<DRV> structure.

**Prototype**

```
void GUIDRV_S1D13<DRV>_Config(GUI_DEVICE      * pDevice,
                             CONFIG_S1D13<DRV> * pConfig);
```

**Parameters**

| Parameter               | Description   |
|-------------------------|---|
| <a href="#">pDevice</a> | Pointer to the driver device.                             |
| <a href="#">pConfig</a> | Pointer to a CONFIG_S1D13<DRV> structure described below. |

**Elements of structure CONFIG\_S1D13<DRV>**

| Data type | Element      | Description  |
|-----------|--------------|--|
| U32       | BufferOffset | This offset added to the VideoRAM start address, results in the start address used for the selected PIP layer. |
| int       | UseLayer     | (see table below)  |

| Permitted values for <a href="#">UseLayer</a> |                     |
|---|---------------------|
| GUIDRV_S1D13<DRV>_USE_PIP1                    | PIP1 should be used |
| GUIDRV_S1D13<DRV>_USE_PIP2                    | PIP2 should be used |

### 11.7.8.6.3 GUIDRV\_S1D13L04\_SetBus16()

### 11.7.8.6.4 GUIDRV\_S1D13513\_SetBus16()

#### Description

Tells the driver to use the 16 bit indirect interface and passes a pointer to a GUI\_PORT\_API structure to the driver containing function pointers to the hardware routines to be used.

#### Prototype

```
void GUIDRV_S1D13513_SetBus16(GUI_DEVICE * pDevice,
                             GUI_PORT_API * pHW_API);
```

#### Parameters

| Parameter            | Description   |
|----------------------|---|
| <code>pDevice</code> | Pointer to the driver device.                                     |
| <code>pHW_API</code> | Pointer to a GUI_PORT_API structure. See required routines below. |

#### Required GUI\_PORT\_API routines

| Data type  | Element                    | Description  |
|--|----------------------------|--|
| <code>void (*)(U16 Data)</code>                  | <code>pfWrite16_A0</code>  | Pointer to a function which writes one word to the index register.                           |
| <code>void (*)(U16 Data)</code>                  | <code>pfWrite16_A1</code>  | Pointer to a function which writes one word to the data register.                            |
| <code>void (*)(U16 * pData, int NumItems)</code> | <code>pfWriteM16_A1</code> | Pointer to a function which writes multiple words to the data register.                      |
| <code>U16 (*)(void)</code>                       | <code>pfRead16_A0</code>   | Pointer to a function which reads one word from the index register.                          |
| <code>U16 (*)(void)</code>                       | <code>pfRead16_A1</code>   | Pointer to a function which reads one word from the data register.                           |
| <code>void (*)(U16 * pData, int NumItems)</code> | <code>pfReadM16_A1</code>  | Pointer to a function which reads multiple words from the data register.                     |
| <code>void (*)(void)</code>                      | <code>pfFlushBuffer</code> | Pointer to a function which waits until the busy flag of the status register is cleared (0). |

#### Special requirements

The driver needs to work with the fixed palette modes explained above. It further requires a function which waits until the busy flag of the status register is cleared.

## 11.7.9 GUIDRV\_S1D13L02

### 11.7.10 GUIDRV\_S1D13748

#### Note

From a technical point of view both drivers are identically.

- <DRV> = 'L02': GUIDRV\_S1D13L02
- <DRV> = '748': GUIDRV\_S1D13748

#### 11.7.10.1 Supported hardware

##### Controllers

This driver has been tested with the Epson S1D13<DRV>.

##### Bits per pixel

The supported color depth is 16 bpp.

##### Interfaces

The driver supports the 16-bit indirect interface.

#### 11.7.10.2 Basic function

The driver currently supports indirect mode only. Only 2 registers, namely register 0 and 2 are used.

##### Hardware interface

AB[1] = GND  
 AB[2] = Used as Address pin  
 AB[3] = GND

| AB[3:0] | Register               |
|---------|------------------------|
| 000     | Index                  |
| 001     | Status                 |
| 010     | Data                   |
| 011     | Reserved               |
| 100     | GPIO Status            |
| 101     | GPIO Config            |
| 110     | GPIO Input Enable      |
| 111     | GPIO Pull-down Control |

##### Reset

The RESET pin should be connected to the system reset. The RESET pin of the Microcontroller / CPU is usually called NRESET.

#### 11.7.10.3 Driver selection

To use GUIDRV\_S1D13<DRV> for the given display, the following command should be used:

```
pDevice = GUI_DEVICE_CreateAndLink(GUIDRV_S1D13<DRV>, GUICC_M565, 0, 0);
```

### 11.7.10.4 Display data RAM organization

**16 bits per pixel, fixed palette = 565**

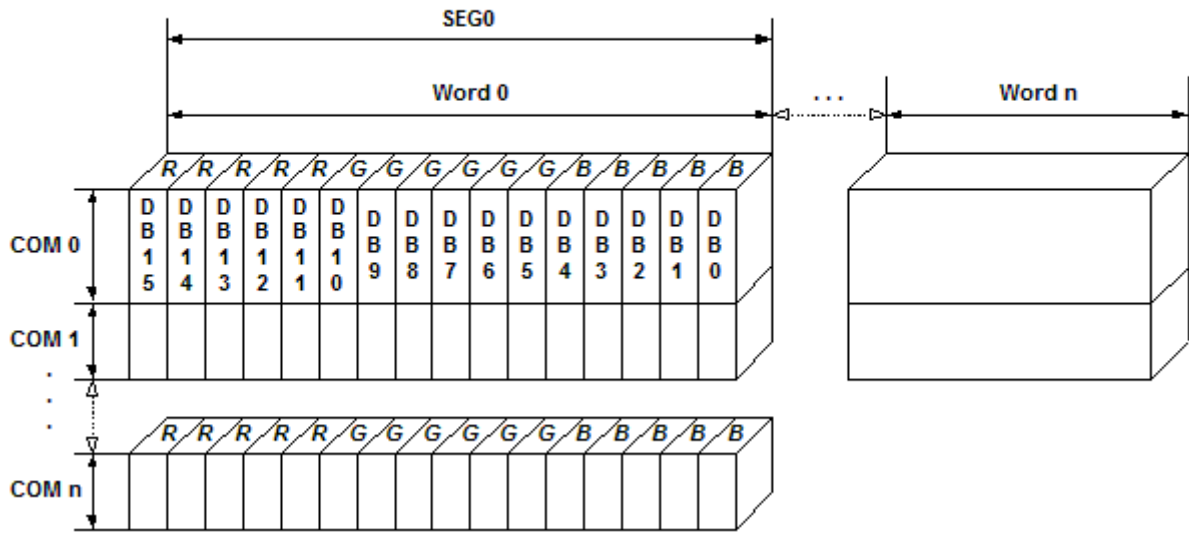

Relationship between memory and the SEG and COM lines.

### 11.7.10.5 RAM requirements

Approximately 500 bytes.

### 11.7.10.6 Run-time configuration

The table below shows the available run-time configuration routines of this driver:

| Routine  | Description   |
|--|---|
| <a href="#">GUIDRV_S1D13L02_Config()</a><br><a href="#">GUIDRV_S1D13748_Config()</a>     | Passes a pointer to a <code>CONFIG_S1D13&lt;DRV&gt;</code> structure to the driver.                                       |
| <a href="#">GUIDRV_S1D13L02_SetBus16()</a><br><a href="#">GUIDRV_S1D13748_SetBus16()</a> | Configures the driver to use the 16 bit indirect interface by passing a pointer to a <code>GUI_PORT_API</code> structure. |



### 11.7.10.6.1 GUIDRV\_S1D13L02\_Config()

### 11.7.10.6.2 GUIDRV\_S1D13748\_Config()

#### Description

Configures the driver to work according to the passed CONFIG\_S1D13<DRV> structure.

#### Prototype

```
void GUIDRV_S1D13<DRV>_Config(GUI_DEVICE      * pDevice,
                             CONFIG_S1D13<DRV> * pConfig);
```

#### Parameters

| Parameter               | Description   |
|-------------------------|---|
| <a href="#">pDevice</a> | Pointer to the driver device.                             |
| <a href="#">pConfig</a> | Pointer to a CONFIG_S1D13<DRV> structure described below. |

#### Elements of structure CONFIG\_S1D13<DRV>

| Data type | Element      | Description  |
|-----------|--------------|--|
| U32       | BufferOffset | This offset added to the VideoRAM start address, results in the start address used for the selected PIP layer. |
| int       | UseLayer     | PIP layer to be used.  |

**11.7.10.6.3 GUIDRV\_S1D13L02\_SetBus16()****11.7.10.6.4 GUIDRV\_S1D13748\_SetBus16()****Description**

Tells the driver to use the 16 bit indirect interface and passes a pointer to a `GUI_PORT_API` structure to the driver containing function pointers to the hardware routines to be used.

**Prototype**

```
void GUIDRV_S1D13748_SetBus16(GUI_DEVICE * pDevice,
                             GUI_PORT_API * pHW_API);
```

**Parameters**

| Parameter            | Description  |
|----------------------|--|
| <code>pDevice</code> | Pointer to the driver device.  |
| <code>pHW_API</code> | Pointer to a <code>GUI_PORT_API</code> structure. See required routines below. |

**11.7.10.7 Required GUI\_PORT\_API routines**

| Data type  | Element                    | Description  |
|--|----------------------------|--|
| <code>void (*)(U16 Data)</code>                  | <code>pfWrite16_A0</code>  | Pointer to a function which writes one word to the controller with C/D line low.         |
| <code>void (*)(U16 Data)</code>                  | <code>pfWrite16_A1</code>  | Pointer to a function which writes one word to the controller with C/D line high.        |
| <code>void (*)(U16 * pData, int NumItems)</code> | <code>pfWriteM16_A1</code> | Pointer to a function which writes multiple words to the controller with C/D line high.  |
| <code>U16 (*)(void)</code>                       | <code>pfRead16_A1</code>   | Pointer to a function which reads one word from the controller with C/D line high.       |
| <code>void (*)(U16 * pData, int NumItems)</code> | <code>pfReadM16_A1</code>  | Pointer to a function which reads multiple words from the controller with C/D line high. |

**11.7.10.8 Special requirements**

The driver needs to work with the fixed palette mode `GUICC_M565`. The driver does not work with other palettes or fixed palette modes.

## 11.7.11 GUIDRV\_S1D13L01

## 11.7.12 GUIDRV\_S1D13781

### Note

From a technical point of view both drivers are identically.

- <DRV> = 'L01': GUIDRV\_S1D13L01
- <DRV> = '781': GUIDRV\_S1D13781

### 11.7.12.1 Supported hardware

#### Controllers

This driver has been tested with the Epson S1D13<DRV>.

#### Bits per pixel

Currently the supported color depth is 8 and 16 bpp. This can be enhanced on demand.

#### Interfaces

Currently the driver supports only the 8-bit indirect serial host interface. Can be enhanced on demand.

### 11.7.12.2 Display orientation

The driver can be used with different orientations. The following table shows the configuration macros which can be used to create and link the driver during the initialization:

| Identifier                 | Color depth and orientation             |
|----------------------------|---|
| GUIDRV_S1D13<DRV>_8C0      | 8bpp, default orientation               |
| GUIDRV_S1D13<DRV>_OXY_8C0  | 8bpp, X and Y axis mirrored             |
| GUIDRV_S1D13<DRV>_OSY_8C0  | 8bpp, X axis mirrored, X and Y swapped  |
| GUIDRV_S1D13<DRV>_OSX_8C0  | 8bpp, Y axis mirrored, X and Y swapped  |
| GUIDRV_S1D13<DRV>_16C0     | 16bpp, default orientation              |
| GUIDRV_S1D13<DRV>_OXY_16C0 | 16bpp, X and Y axis mirrored            |
| GUIDRV_S1D13<DRV>_OSY_16C0 | 16bpp, X axis mirrored, X and Y swapped |
| GUIDRV_S1D13<DRV>_OSX_16C0 | 16bpp, Y axis mirrored, X and Y swapped |

The table above shows identifiers which can be used to select the driver.

### 11.7.12.3 Driver selection

To use GUIDRV\_S1D13<DRV> for the given display, the following command should be used for the 8bpp version:

```
pDevice = GUI_DEVICE_CreateAndLink(GUIDRV_S1D13<DRV>_8C0, GUICC_8666, 0, 0);
```

To use the 16bpp version use the following command:

```
pDevice = GUI_DEVICE_CreateAndLink(GUIDRV_S1D13<DRV>_16C0, GUICC_M565, 0, 0);
```

### 11.7.12.4 Display data RAM organization

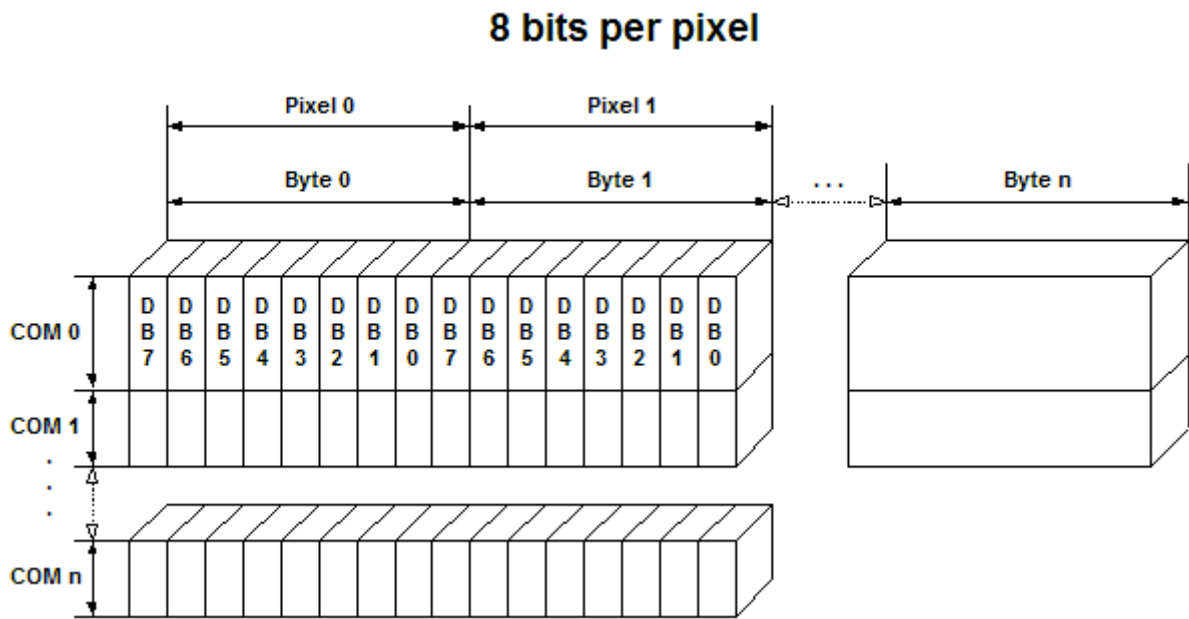

Relationship between memory and the SEG and COM lines for 8bpp mode.

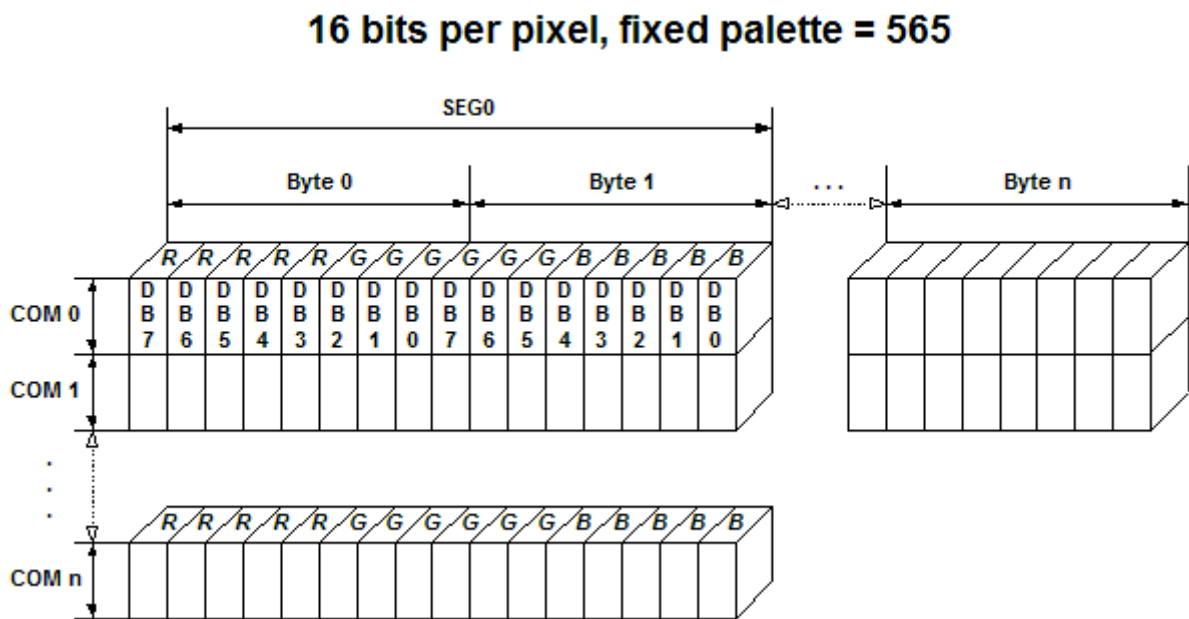

Relationship between memory and the SEG and COM lines for 16bpp mode.

### 11.7.12.5 RAM requirements

Approximately 1 KB.

### 11.7.12.6 Run-time configuration

The table below shows the available run-time configuration routines of this driver:

| Routine  | Description   |
|--|---|
| <code>GUIDRV_S1D13L01_Config()</code><br><code>GUIDRV_S1D13781_Config()</code> | Passes a pointer to a <code>CONFIG_S1D13&lt;DRV&gt;</code> structure to the driver. |

| Routine  | Description   |
|--|---|
| GUIDRV_S1D13L01_SetBusSPI()<br>GUIDRV_S1D13781_SetBusSPI()           | Configures the driver to use the 8 bit indirect serial host interface by passing a pointer to a GUI_PORT_API structure. |
| GUIDRV_S1D13L01_SetOrientation()<br>GUIDRV_S1D13781_SetOrientation() | Sets a new orientation for the given layer.   |

**11.7.12.6.1 GUIDRV\_S1D13L01\_Config()****11.7.12.6.2 GUIDRV\_S1D13781\_Config()****Description**

Configures the driver to work according to the passed CONFIG\_S1D13<DRV> structure.

**Prototype**

```
void GUIDRV_S1D13<DRV>_Config(GUI_DEVICE      * pDevice,
                             CONFIG_S1D13<DRV> * pConfig);
```

**Parameters**

| Parameter            | Description   |
|----------------------|---|
| <code>pDevice</code> | Pointer to the driver device.                             |
| <code>pConfig</code> | Pointer to a CONFIG_S1D13<DRV> structure described below. |

**Elements of structure CONFIG\_S1D13<DRV>**

| Data type | Element         | Description  |
|-----------|-----------------|--|
| U32       | BufferOffset    | This offset added to the VideoRAM start address, results in the start address used for the selected PIP layer.   |
| int       | WriteBufferSize | Number of bytes used for the write buffer. The buffer should be large enough to be able to store at least one line of data + 5 bytes. Because the layer size can be changed dynamically, it is required to set up the buffer size during the configuration. The default value of the buffer size is 500 bytes. |
| int       | UseLayer        | Should be 1 if PIP layer should be used.   |
| int       | WaitUntilVNDP   | Used for Multiple Buffering configurations only. If set to 1 the driver waits until the next vertical non display period has been reached. This can be used to reduce flickering effects with fast animations.   |

### 11.7.12.6.3 GUIDRV\_S1D13L01\_SetBusSPI()

### 11.7.12.6.4 GUIDRV\_S1D13781\_SetBusSPI()

#### Description

Tells the driver to use the 8 bit indirect serial host interface and passes a pointer to a `GUI_PORT_API` structure to the driver containing function pointers to the hardware routines to be used.

#### Prototype

```
void GUIDRV_S1D13781_SetBusSPI(GUI_DEVICE * pDevice,  
                               GUI_PORT_API * pHW_API);
```

#### Parameters

| Parameter            | Description  |
|----------------------|--|
| <code>pDevice</code> | Pointer to the driver device.  |
| <code>pHW_API</code> | Pointer to a <code>GUI_PORT_API</code> structure. See required routines below. |

### 11.7.12.6.5 GUIDRV\_S1D13L01\_SetOrientation()

### 11.7.12.6.6 GUIDRV\_S1D13781\_SetOrientation()

#### Description

This function set the given orientation for the given layer.

#### Prototype

```
int GUIDRV_S1D13781_SetOrientation(int Orientation,
                                   int LayerIndex);
```

#### Parameters

| Parameter                   | Description   |
|-----------------------------|---|
| <a href="#">Orientation</a> | The orientation to be used.                           |
| <a href="#">LayerIndex</a>  | Index of the layer the orientation should be set for. |

#### Return value

0        on success  
1        on error.

## 11.7.12.7 Required GUI\_PORT\_API routines

| Data type                          | Element                      | Description   |
|------------------------------------|------------------------------|---|
| void (*)(U8 Data)                  | <a href="#">pfWrite8_A0</a>  | Pointer to a function which writes one byte to the controller with C/D line low.  |
| void (*)(U8 Data)                  | <a href="#">pfWrite8_A1</a>  | Pointer to a function which writes one byte to the controller with C/D line high.   |
| void (*)(U8 * pData, int NumItems) | <a href="#">pfWriteM8_A1</a> | Pointer to a function which writes multiple bytes to the controller with C/D line high.   |
| U8 (*)(void)                       | <a href="#">pfRead8_A1</a>   | Pointer to a function which reads one byte from the controller with C/D line high.  |
| void (*)(U8 * pData, int NumItems) | <a href="#">pfReadM8_A1</a>  | Pointer to a function which reads multiple bytes from the controller with C/D line high.  |
| void (*)(U8 NotActive)             | <a href="#">pfSetCS</a>      | Routine which is able to toggle the CS signal of the controller:<br>NotActive = 1 means CS = high<br>NotActive = 0 means CS = low |

## 11.7.12.8 Optional functions

The following table shows the optional LCD-functions which are available with this driver:

| Routine                              | Description                                       |
|--------------------------------------|---|
| <a href="#">GUI_GetLayerPosEx()</a>  | Returns the X- and Y-position of the given layer. |
| <a href="#">GUI_SetLayerPosEx()</a>  | Sets the X- and Y-position of the given layer.    |
| <a href="#">GUI_SetLayerSizeEx()</a> | Sets the X- and Y-size of the given layer.        |
| <a href="#">GUI_SetLayerVisEx()</a>  | Sets the visibility of the given layer.           |
| <a href="#">LCD_SetAlphaEx()</a>     | Sets the layer alpha value of the given layer.    |



| Routine                               | Description                                     |
|---------------------------------------|---|
| <a href="#">LCD_SetChromaEx()</a>     | Sets the colors to be used for the chroma mode. |
| <a href="#">LCD_SetChromaModeEx()</a> | Enables the chroma mode of the given layer.     |

More details about the optional functions can be found in *MultiLayer API* on page 2913.

### 11.7.12.9 Additional information

The display driver automatically initializes the following registers:

| Register | Description           |
|----------|-----------------------|
| 0x60824  | X-size of main layer. |
| 0x60828  | Y-size of main layer. |
| 0x60840  | Main layer settings.  |

This means the above registers do not need to be initialized by the applications initialization code for the display controller.

## 11.7.13 GUIDRV\_S1D15G00

### 11.7.13.1 Supported hardware

#### Controllers

The driver supports the Epson S1D15G00 controller.

#### Bits per pixel

Supported color depth is 12bpp.

#### Interfaces

The driver supports the 8 bit indirect interface.

### 11.7.13.2 Driver selection

To use GUIDRV\_S1D15G00 for the given display, the following command should be used:

```
pDevice = GUI_DEVICE_CreateAndLink(GUIDRV_S1D15G00, GUICC_M444_12, 0, 0);
```

### 11.7.13.3 Display data RAM organization

#### 12 bits per pixel, fixed palette = M444\_12

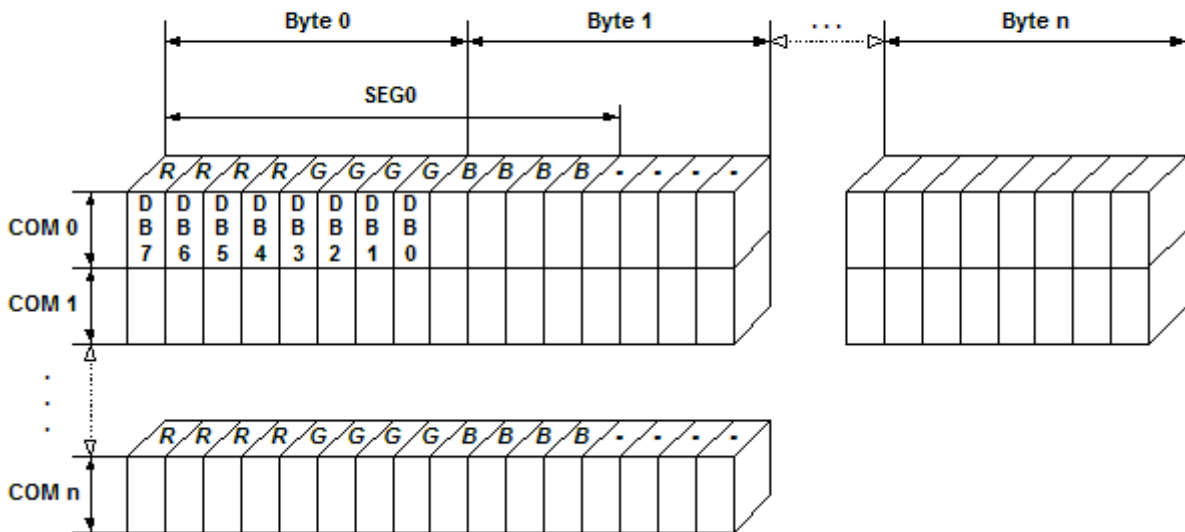

The picture above shows the relation between the display memory and the SEG and COM lines of the LCD.

### 11.7.13.4 RAM requirements

This display driver can be used with and without a display data cache, containing a complete copy of the contents of the LCD data RAM. The amount of memory used by the cache is:

```
LCD_XSIZE * LCD_YSIZE * 2 bytes
```

Using a cache is recommended only if a lot of drawing operations uses the XOR drawing mode. A cache would avoid reading the display data in this case. Normally the use of a cache is not recommended.

### 11.7.13.5 Run-time configuration

The table below shows the available run-time configuration routines of this driver:

| Routine                                | Description  |
|--|--|
| <code>GUIDRV_S1D15G00_Config()</code>  | Passes a pointer to a <code>CONFIG_S1D15G00</code> structure to the driver.  |
| <code>GUIDRV_S1D15G00_SetBus8()</code> | Tells the driver to use the 8 bit indirect interface and passes a pointer to a <code>GUI_PORT_API</code> structure to the driver containing function pointers to the hardware routines to be used. |

### 11.7.13.5.1 GUIDRV\_S1D15G00\_Config()

#### Description

Passes a pointer to a CONFIG\_S1D15G00 structure to the driver.

#### Prototype

```
void GUIDRV_S1D15G00_Config(GUI_DEVICE      * pDevice,
                           CONFIG_S1D15G00 * pConfig);
```

#### Parameters

| Parameter            | Description   |
|----------------------|---|
| <code>pDevice</code> | Pointer to the driver device.                           |
| <code>pConfig</code> | Pointer to a CONFIG_S1D15G00 structure described below. |

#### Elements of structure CONFIG\_S1D15G00

| Data type | Element  | Description  |
|-----------|----------|--|
| int       | FirstSEG | First segment address to be used in the data RAM of the display controller. The value can be determined experimentally or taken from the display documentation. The value is normally 0. |
| int       | FirstCOM | First common address to be used in the data RAM of the display controller. The value can be determined experimentally or taken from the display documentation. The value is normally 0.  |
| int       | UseCache | Enables or disables use of a data cache. Should be set to 1 for enabling and to 0 for disabling.   |

### 11.7.13.5.2 GUIDRV\_S1D15G00\_SetBus8()

#### Description

Tells the driver to use the 8 bit indirect interface and passes a pointer to a GUI\_PORT\_API structure to the driver containing function pointers to the hardware routines to be used.

#### Prototype

```
void GUIDRV_S1D15G00_SetBus8(GUI_DEVICE * pDevice,
                             GUI_PORT_API * pHW_API);
```

#### Parameters

| Parameter            | Description   |
|----------------------|---|
| <code>pDevice</code> | Pointer to the driver device.                                     |
| <code>pHW_API</code> | Pointer to a GUI_PORT_API structure. See required routines below. |

### 11.7.13.6 Required GUI\_PORT\_API routines

| Data type                                       | Element                   | Description   |
|---|---------------------------|---|
| <code>void (*)(U8 Data)</code>                  | <code>pfWrite8_A0</code>  | Pointer to a function which writes one byte to the controller with C/D line low.        |
| <code>void (*)(U8 Data)</code>                  | <code>pfWrite8_A1</code>  | Pointer to a function which writes one byte to the controller with C/D line high.       |
| <code>void (*)(U8 * pData, int NumItems)</code> | <code>pfWriteM8_A1</code> | Pointer to a function which writes multiple bytes to the controller with C/D line high. |
| <code>U8 (*)(void)</code>                       | <code>pfRead8_A1</code>   | Pointer to a function which reads one byte from the controller with C/D line high.      |

### 11.7.13.7 Configuration example

```
#define XSIZE 130
#define YSIZE 130
GUI_PORT_API _PortAPI;
void LCD_X_Config(void) {
    GUI_DEVICE * pDevice;
    CONFIG_S1D15G00 Config = {0};
    //
    // Set display driver and color conversion for 1st layer
    //
    pDevice = GUI_DEVICE_CreateAndLink(GUIDRV_S1D15G00, GUICC_M444_12, 0, 0);
    //
    // Display driver configuration
    //
    LCD_SetSizeEx (0, XSIZE, YSIZE);
    LCD_SetVSizeEx(0, XSIZE, YSIZE);
    //
    // Driver specific configuration
    //
    Config.FirstCOM = 2;
    GUIDRV_S1D15G00_Config(pDevice, &Config);
    //
    // Setup hardware access routines
    //
    _PortAPI.pfWrite8_A0 = _Write_A0;
    _PortAPI.pfWrite8_A1 = _Write_A1;
    _PortAPI.pfWriteM8_A1 = _WriteM_A1;
    GUIDRV_S1D15G00_SetBus8(pDevice, &PortAPI);
}
```

## 11.7.14 GUIDRV\_SH\_MEM

The driver supports Sharp Memory LCDs. Those kind of displays do not support reading back the display content. Further this LCDs do not support writing single pixels. The smallest unit for a writing operation is one complete line of pixels. Because of that a cache is required in the driver. To achieve the best possible performance it is recommended to lock and unlock the cache before/after large drawing operations.

### VCOM signal

Sharp Memory LCDs require a VCOM signal which should be toggled with a frequency of approx. 500-1000ms. That could be achieved per hardware (EXTMODE=H) or per software (EXTMODE=L). EXTMODE is the configuration pin of the LCD.

### EXTMODE = H

There are 2 possible ways to achieve toggling the EXTCOMIN signal. One solution is toggling the signal by a timer interrupt or a similar routine which is called with the required frequency. The second solution is using the function `GUIDRV_SH_MEM_Config()` explained later and uses a custom function called periodically by the driver.

### EXTMODE = L

In that case the driver uses the software interface of the Sharp Memory LCD to toggle the V-bit. The function `GUIDRV_SH_MEM_Config()` should be used to set the desired period.

### 11.7.14.1 Supported hardware

#### Displays

Sharp Memory LCDs (b/w and 3bpp) with 8- or 10 bit address interface and compatible displays.

#### Bits per pixel

Supported color depth is 1 and 3bpp.

#### Interfaces

The driver supports the indirect serial interface required for using that kind of LCDs.

### 11.7.14.2 Display orientation

The driver consists of several files. They are named `_[O].c` where the optional `O` stands for the desired display orientation. The following table shows the configuration macros which should be used to select the desired display orientation during the initialization:

| Identifier                       | Color depth and orientation                                     |
|----------------------------------|---|
| <code>GUIDRV_SH_MEM</code>       | 1bpp, default orientation                                       |
| <code>GUIDRV_SH_MEM_OSX</code>   | 1bpp, X and Y axis swapped, X mirrored (rotated CCW 90 degrees) |
| <code>GUIDRV_SH_MEM_OSY</code>   | 1bpp, X and Y axis swapped, Y mirrored (rotated CW 90 degrees)  |
| <code>GUIDRV_SH_MEM_OXY</code>   | 1bpp, X and Y axis mirrored (turned by 180 degrees)             |
| <code>GUIDRV_SH_MEM_3</code>     | 3bpp, default orientation                                       |
| <code>GUIDRV_SH_MEM_OSX_3</code> | 3bpp, X and Y axis swapped, X mirrored (rotated CCW 90 degrees) |
| <code>GUIDRV_SH_MEM_OSY_3</code> | 3bpp, X and Y axis swapped, Y mirrored (rotated CW 90 degrees)  |
| <code>GUIDRV_SH_MEM_OXY_3</code> | 3bpp, X and Y axis mirrored (turned by 180 degrees)             |

### 11.7.14.3 Driver selection

The following command could be used in LCD\_X\_Config():

```
pDevice = GUI_DEVICE_CreateAndLink(GUIDRV_SH_MEM, GUICC_1, 0, 0);
```

### 11.7.14.4 Display data RAM organization 1bpp

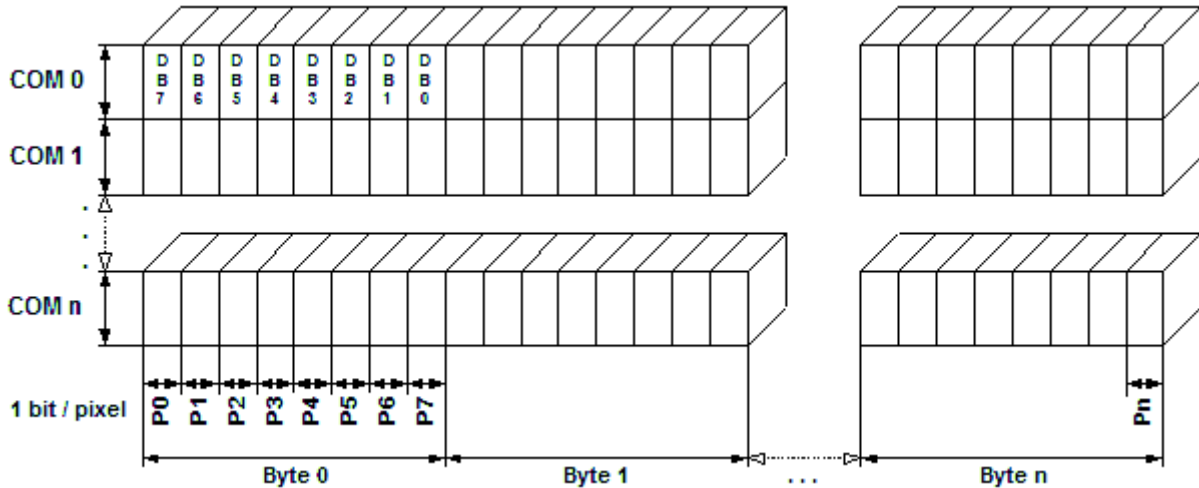

The picture above shows the relation between the display memory and the SEG and COM lines of the LCD.

### 11.7.14.5 Display data RAM organization 3bpp

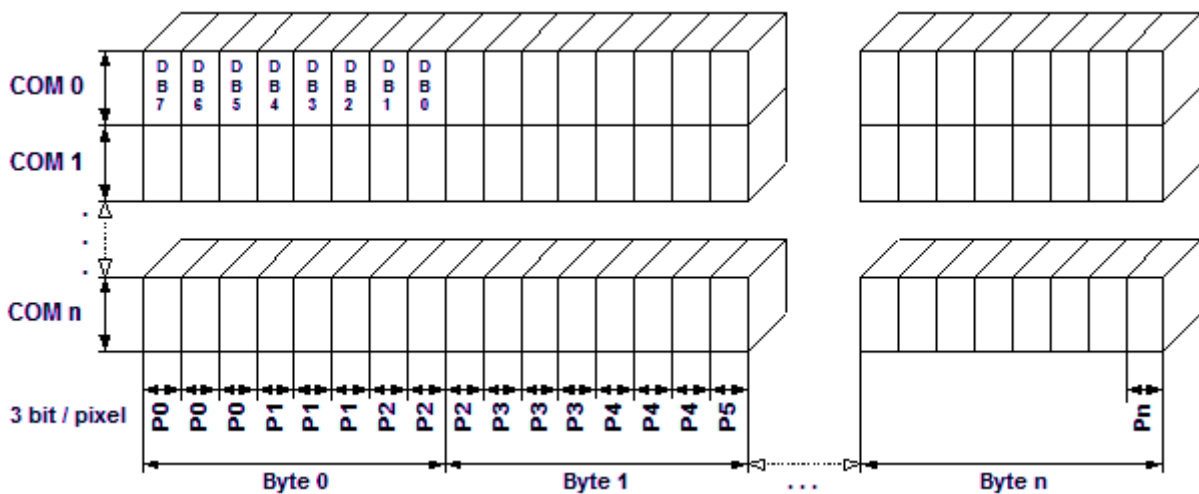

The picture above shows the relation between the display memory and the SEG and COM lines of the LCD.

### 11.7.14.6 RAM requirements

This display driver requires a display data cache containing a complete copy of the content of the LCD data RAM. The amount of memory used by the cache in bytes is:

$$\text{LCD\_YSIZE} * (\text{LCD\_XSIZE} * \text{BitsPerPixel} + 7) / 8 + (\text{LCD\_YSIZE} + 7) / 8$$

### 11.7.14.7 Run-time configuration

The table below shows the available run-time configuration routines of this driver:

| Routine                                | Description  |
|--|--|
| <code>GUIDRV_SH_MEM_Config()</code>    | Passes a pointer to a <code>CONFIG_SH_MEM</code> structure to the driver.  |
| <code>GUIDRV_SH_MEM_SetBus8()</code>   | Tells the driver to use the 8 bit indirect interface and passes pointer to a <code>GUI_PORT_API</code> structure to the driver.  |
| <code>GUIDRV_SH_MEM_3_Config()</code>  | Passes a pointer to a <code>CONFIG_SH_MEM</code> structure to the driver.  |
| <code>GUIDRV_SH_MEM_3_SetBus8()</code> | Tells the driver to use the 8 bit indirect interface and passes a pointer to a <code>GUI_PORT_API</code> structure to the driver containing function pointers to the hardware routines to be used. |



### 11.7.14.7.1 GUIDRV\_SH\_MEM\_Config()

### 11.7.14.7.2 GUIDRV\_SH\_MEM\_3\_Config()

#### Description

Passes a pointer to a `CONFIG_SH_MEM` structure to the driver.

#### Prototype

```
void GUIDRV_SH_MEM_3_Config(GUI_DEVICE * pDevice,
                           CONFIG_SH_MEM * pConfig);
```

#### Parameters

| Parameter            | Description  |
|----------------------|--|
| <code>pDevice</code> | Pointer to the driver device.                                      |
| <code>pConfig</code> | Pointer to a <code>CONFIG_SH_MEM</code> structure described below. |

#### Additional information

In most cases the member 'SendEnd' of `CONFIG_SH_MEM` has to be set to 1. Some interfaces automatically send a 'line-end-command'. In these cases 'SendEnd' has to be set to 0.

#### Elements of structure `CONFIG_SH_MEM`

| Data type      | Element                   | Description   |
|----------------|---------------------------|---|
| unsigned       | Period                    | Period for toggling VCOM. In case of 'ExtMode' is set to 1 the driver calls <code>pfToggleVCOM</code> with the given frequency. In case of 'ExtMode' is 0 it toggles the V-bit of the software interface. |
| unsigned       | ExtMode                   | Should be set to the same value as the EXTMODE pin of the LCD. If set to 1 the function pointed by <code>pfToggleVCOM</code> is called periodically for toggling the VCOM pin by a custom function.       |
| unsigned       | ExtMode                   | (see table below)   |
| void (*)(void) | <code>pfToggleVCOM</code> | Function for toggling the EXTCOMIN line of the display.   |
| unsigned       | AddressBitOrder           | Inverts the bit order of the address.   |
| unsigned       | SendEnd                   | Enables sending of line-end-command.  |

| Permitted values for BitMode         |   |
|--------------------------------------|---|
| <code>GUIDRV_SH_MEM_8BITMODE</code>  | Default setting right for the most Memory LCDs.                                     |
| <code>GUIDRV_SH_MEM_10BITMODE</code> | Must be used to support memory LCDs with 10 bit address interface like LS032B7DD02. |

### 11.7.14.7.3 GUIDRV\_SH\_MEM\_SetBus8()

### 11.7.14.7.4 GUIDRV\_SH\_MEM\_3\_SetBus8()

#### Description

Tells the driver to use the 8 bit indirect interface and passes a pointer to a GUI\_PORT\_API structure to the driver containing function pointers to the hardware routines to be used.

#### Prototype

```
void GUIDRV_SH_MEM_3_SetBus8(GUI_DEVICE * pDevice,  
                             GUI_PORT_API * pHW_API);
```

#### Parameters

| Parameter            | Description   |
|----------------------|---|
| <code>pDevice</code> | Pointer to the driver device.                                     |
| <code>pHW_API</code> | Pointer to a GUI_PORT_API structure. See required routines below. |

### 11.7.14.8 Required GUI\_PORT\_API routines

| Data type                          | Element                      | Description  |
|------------------------------------|------------------------------|--|
| void (*)(U8 NotActive)             | <a href="#">pfSetCS</a>      | Pointer to a function which is able to toggle the CS signal of the controller. |
| void (*)(U8 * pData, int NumItems) | <a href="#">pfWriteM8_A1</a> | Pointer to a function which writes multiple bytes to the controller.           |

### 11.7.14.9 Configuration Example

```

#define XSIZE 128
#define YSIZE 128
GUI_PORT_API _PortAPI;
void LCD_X_Config(void) {
    GUI_DEVICE * pDevice;
    GUI_PORT_API PortAPI = {0};
    CONFIG_SH_MEM Config = {0};
    //
    // Set display driver and color conversion
    //
    pDevice = GUI_DEVICE_CreateAndLink(GUIDRV_SH_MEM, GUICC_1, 0, 0);
    //
    // Common display driver configuration
    //
    if (LCD_GetSwapXY()) {
        LCD_SetSizeEx (0, YSIZE_PHYS, XSIZE_PHYS);
    } else {
        LCD_SetSizeEx (0, XSIZE_PHYS, YSIZE_PHYS);
    }
    //
    // Setup hardware access routines
    //
    PortAPI.pfWriteM8_A1 = _WriteM1;
    PortAPI.pfSetCS      = _SetCS;
    GUIDRV_SH_MEM_SetBus8(pDevice, &PortAPI);
    //
    // VCom management
    //
    Config.Period  = 500;
    Config.SendEnd = 1;
    GUIDRV_SH_MEM_Config(pDevice, &Config);
}

```

## 11.7.15 GUIDRV\_SLin

### 11.7.15.1 Supported hardware

#### Controllers

The driver works with the following display controllers:

- Epson S1D13700, S1D13305 (indirect interface only!)
- RAI0 8835
- Solomon SSD1325, SSD1848
- Ultrachip UC1617
- Toshiba T6963

#### Bits per pixel

Supported color depth is 1, 2 and 4 bits per pixel. Please consider that the supported controllers normally do not support all possible color depths to be used with the driver.

#### Interfaces

The driver supports the 8 bit indirect interface.

### 11.7.15.2 Color depth and display orientation

The driver can be used with different orientations and color depths. The following table shows the configuration macros which can be used to create and link the driver during the initialization:

| Identifier         | Color depth and orientation                  |
|--------------------|--|
| GUIDRV_SLIN_1      | 1bpp, default orientation                    |
| GUIDRV_SLIN_OY_1   | 1bpp, Y axis mirrored                        |
| GUIDRV_SLIN_OX_1   | 1bpp, X axis mirrored                        |
| GUIDRV_SLIN_OXY_1  | 1bpp, X and Y axis mirrored                  |
| GUIDRV_SLIN_OS_1   | 1bpp, X and Y swapped                        |
| GUIDRV_SLIN_OSY_1  | 1bpp, X and Y swapped, Y axis mirrored       |
| GUIDRV_SLIN_OSX_1  | 1bpp, X and Y swapped, X axis mirrored       |
| GUIDRV_SLIN_OSXY_1 | 1bpp, X and Y swapped, X and Y axis mirrored |
| GUIDRV_SLIN_2      | 2bpp, default orientation                    |
| GUIDRV_SLIN_OY_2   | 2bpp, Y axis mirrored                        |
| GUIDRV_SLIN_OX_2   | 2bpp, X axis mirrored                        |
| GUIDRV_SLIN_OXY_2  | 2bpp, X axis mirrored, Y axis mirrored       |
| GUIDRV_SLIN_OS_2   | 2bpp, X and Y swapped                        |
| GUIDRV_SLIN_OSY_2  | 2bpp, X and Y swapped, Y axis mirrored       |
| GUIDRV_SLIN_OSX_2  | 2bpp, X and Y swapped, X axis mirrored       |
| GUIDRV_SLIN_OSXY_2 | 2bpp, X and Y swapped, Y and X axis mirrored |
| GUIDRV_SLIN_4      | 4bpp, default orientation                    |
| GUIDRV_SLIN_OY_4   | 4bpp, Y axis mirrored                        |
| GUIDRV_SLIN_OX_4   | 4bpp, X axis mirrored                        |
| GUIDRV_SLIN_OXY_4  | 4bpp, X axis mirrored, Y axis mirrored       |
| GUIDRV_SLIN_OS_4   | 4bpp, X and Y swapped                        |
| GUIDRV_SLIN_OSY_4  | 4bpp, X and Y swapped, Y axis mirrored       |
| GUIDRV_SLIN_OSX_4  | 4bpp, X and Y swapped, X axis mirrored       |

| Identifier         | Color depth and orientation                  |
|--------------------|--|
| GUIDRV_SLIN_OSXY_4 | 4bpp, X and Y swapped, Y and X axis mirrored |

### 11.7.15.3 Driver selection

To use GUIDRV\_SLin for the given display, the following command can be used e.g.:

```
pDevice = GUI_DEVICE_CreateAndLink(GUIDRV_SLIN_OX_1, GUICC_1, 0, 0);
```

Detailed information about palette modes can be found in the chapter *Colors* on page 478.

### 11.7.15.4 Display data RAM organization

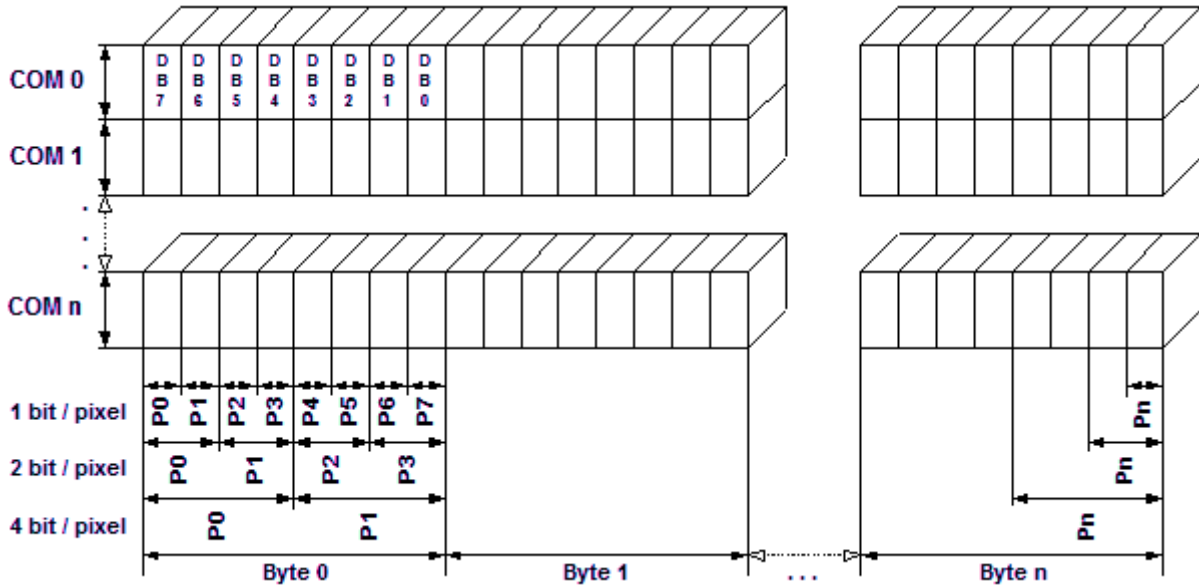

The picture above shows the relation between the display memory and the SEG and COM lines of the display.

### 11.7.15.5 RAM requirements

This display driver may be used with or without a display data cache, containing a complete copy of the frame buffer. If no cache is used, the driver only requires approx. 256 bytes of RAM.

It is recommended to use this driver with a data cache for faster LCD-access. The additional amount of memory used by the cache may be calculated as follows:

$$\text{Size of RAM (in bytes)} = \text{BitsPerPixel} * (\text{LCD\_XSIZE} + 7) / 8 * \text{LCD\_YSIZE}$$

### 11.7.15.6 Run-time configuration

The table below shows the available run-time configuration routines of this driver:

| Routine                                   | Description   |
|---|---|
| <a href="#">GUIDRV_SLin_Config()</a>      | Passes a pointer to a CONFIG_SLIN structure to the driver.  |
| <a href="#">GUIDRV_SLin_SetBus8()</a>     | Tells the driver to use the 8 bit indirect interface and passes pointer to a GUI_PORT_API structure to the driver.                    |
| <a href="#">GUIDRV_SLin_SetS1D13700()</a> | Set up the driver to use one of the following controllers: <ul style="list-style-type: none"> <li>Epson S1D13700, S1D13305</li> </ul> |

| Routine                               | Description  |
|---------------------------------------|--|
|                                       | <ul style="list-style-type: none"><li>• RAI0 8835</li></ul>  |
| <code>GUIDRV_SLin_SetSSD1325()</code> | Set up the driver to use one of the following controllers: <ul style="list-style-type: none"><li>• Solomon SSD1325</li><li>• Solomon SSD1327</li></ul> |
| <code>GUIDRV_SLin_SetSSD1848()</code> | Set up the driver to use one of the following controllers: <ul style="list-style-type: none"><li>• Solomon SSD1848</li></ul>                           |
| <code>GUIDRV_SLin_SetT6963()</code>   | Set up the driver to use one of the following controllers: <ul style="list-style-type: none"><li>• Toshiba T6963</li></ul>                             |
| <code>GUIDRV_SLin_SetUC1617()</code>  | Set up the driver to use one of the following controllers: <ul style="list-style-type: none"><li>• Ultrachip UC1617</li></ul>                          |

### 11.7.15.6.1 GUIDRV\_SLin\_Config()

#### Description

Passes a pointer to a CONFIG\_SLIN structure to the driver.

#### Prototype

```
void GUIDRV_SLin_Config(GUI_DEVICE * pDevice,
                       CONFIG_SLIN * pConfig);
```

#### Parameters

| Parameter            | Description   |
|----------------------|---|
| <code>pDevice</code> | Pointer to the driver device.                       |
| <code>pConfig</code> | Pointer to a CONFIG_SLIN structure described below. |

#### Elements of structure CONFIG\_SLIN

| Data type | Element     | Description  |
|-----------|-------------|--|
| int       | FirstSEG    | First segment address to be used in the data RAM of the display controller. The value can be determined experimentally or taken from the display documentation. The value is normally 0. |
| int       | FirstCOM    | First common address to be used in the data RAM of the display controller. The value can be determined experimentally or taken from the display documentation. The value is normally 0.  |
| int       | UseCache    | Enables or disables use of a data cache. Should be set to 1 for enabling and to 0 for disabling.   |
| int       | UseDualScan | Used only for the T6963. This element should be set to 1 in case a dual screen LCD is used.  |
| int       | UseMirror   | Used only for the SSD1848. Should be normally 1.   |

### 11.7.15.6.2 GUIDRV\_SLin\_SetBus8()

#### Description

Tells the driver to use the 16 bit indirect interface and passes a pointer to a GUI\_PORT\_API structure to the driver containing function pointers to the hardware routines to be used.

#### Prototype

```
void GUIDRV_Slin_SetBus8(GUI_DEVICE * pDevice,
                        GUI_PORT_API * pHW_API);
```

#### Parameters

| Parameter               | Description   |
|-------------------------|---|
| <a href="#">pDevice</a> | Pointer to the driver device                                      |
| <a href="#">pHW_API</a> | Pointer to a GUI_PORT_API structure. See required routines below. |

#### Required GUI\_PORT\_API routines

| Element                      | Data type                          |
|------------------------------|------------------------------------|
| <a href="#">pfWrite8_A0</a>  | void (*)(U8 Data)                  |
| <a href="#">pfWrite8_A1</a>  | void (*)(U8 Data)                  |
| <a href="#">pfWriteM8_A0</a> | void (*)(U8 * pData, int NumItems) |
| <a href="#">pfWriteM8_A1</a> | void (*)(U8 * pData, int NumItems) |
| <a href="#">pfRead8_A1</a>   | U8 (*)(void)                       |



### 11.7.15.6.3 GUIDRV\_SLin\_SetS1D13700()

#### Description

Tells the driver that an Epson S1D13700 or S1D13305 controller should be used. Works also for RAIO 8835.

#### Prototype

```
void GUIDRV_SLin_SetS1D13700(GUI_DEVICE * pDevice);
```

#### Parameters

| Parameter            | Description                  |
|----------------------|------------------------------|
| <code>pDevice</code> | Pointer to the driver device |

#### 11.7.15.6.4 GUIDRV\_SLin\_SetSSD1325()

##### Description

Tells the driver that a Solomon SSD1325 controller should be used.

##### Prototype

```
void GUIDRV_SLin_SetSSD1325(GUI_DEVICE * pDevice);
```

##### Parameters

| Parameter            | Description                  |
|----------------------|------------------------------|
| <code>pDevice</code> | Pointer to the driver device |

### 11.7.15.6.5 GUIDRV\_SLin\_SetSSD1848()

#### Description

Tells the driver that a Solomon SSD1848 controller should be used.

#### Prototype

```
void GUIDRV_SLin_SetSSD1848(GUI_DEVICE * pDevice);
```

#### Parameters

| Parameter            | Description                  |
|----------------------|------------------------------|
| <code>pDevice</code> | Pointer to the driver device |

### 11.7.15.6.6 GUIDRV\_SLin\_SetT6963()

#### Description

Tells the driver that a Toshiba T6963 controller should be used.

#### Prototype

```
void GUIDRV_SLin_SetT6963(GUI_DEVICE * pDevice);
```

#### Parameters

| Parameter            | Description                  |
|----------------------|------------------------------|
| <code>pDevice</code> | Pointer to the driver device |

### 11.7.15.6.7 GUIDRV\_SLin\_SetUC1617()

#### Description

Tells the driver that an Ultrachip UC1617 controller should be used.

#### Prototype

```
void GUIDRV_SLin_SetUC1617(GUI_DEVICE * pDevice);
```

#### Parameters

| Parameter            | Description                  |
|----------------------|------------------------------|
| <code>pDevice</code> | Pointer to the driver device |

### 11.7.15.7 Configuration example

```
#define YSIZE 240
void LCD_X_Config(void) {
    GUI_DEVICE * pDevice;
    CONFIG_SLIN Config = {0};
    GUI_PORT_API PortAPI = {0};
    //
    // Set display driver and color conversion
    //
    pDevice = GUI_DEVICE_CreateAndLink(GUIDRV_SLIN_2, GUICC_2, 0, 0);
    //
    // Common display driver configuration
    //
    LCD_SetSizeEx (0, XSIZE, YSIZE);
    LCD_SetVSizeEx(0, XSIZE, YSIZE);
    //
    // Driver specific configuration
    //
    Config.UseCache = 1;
    GUIDRV_SLin_Config(pDevice, &Config);
    //
    // Select display controller
    //
    GUIDRV_SLin_SetS1D13700(pDevice);
    //
    // Setup hardware access routines
    //
    PortAPI.pfWrite16_A0 = _Write0;
    PortAPI.pfWrite16_A1 = _Write1;
    PortAPI.pfWriteM16_A0 = _WriteM0;
    PortAPI.pfRead16_A1 = _Read1;
    GUIDRV_SLin_SetBus8(pDevice, &PortAPI);
}
```

## 11.7.16 GUIDRV\_SLinEPD

### 11.7.16.1 Description

This driver is written to drive an electronic paper display (EPD) controller. Since EPD controller do not behave like typical LCD controllers it requires some special treatment.

#### Updating the display

Since most devices using an EPD are designed to have a low power consumption emWin puts the EPD controller into a deep sleep mode after performing a screen update. When writing to the display emWin sends a `LCD_X_INITCONTROLLER` command to the driver callback `LCD_X_DisplayDriver()` to wake up the controller. Therefore `LCD_X_DisplayDriver()` gets called multiple times with `LCD_X_INITCONTROLLER` command.

The user has multiple options to update the screen after performing drawing operations with emWin.

- Call `LCD_Refresh()`
- Configure the driver for auto update mode
- Locking and unlocking the cache (for UC8451)

Per default the driver does not update the screen automatically and the user has to call `LCD_Refresh()` manually after performing the last drawing operation.

The `GUIDRV_SLinEPD` driver offers an auto update mode. When using this mode the driver checks periodically for changes in the driver cache and updates the screen automatically if changes are detected. This mode can be enabled by setting an auto update period with the function `GUIDRV_SLinEPD_Config()`.

#### Partial update

Per default the driver refreshes the entire display if `LCD_Refresh()` gets called or the a change is detected in auto update mode. With the function `GUIDRV_SLinEPD_EnablePartialMode()` it is possible to update only changed areas of the screen to reduce BUS traffic.

Due to the nature of EPDs this mode might cause artifacts on the screen showing the previous content ("ghosting" effect). This is caused by non-initialized pixels on the EPD.

The UltraChip UC8451 is always in partial mode and updates only the necessary parts of the display.

#### Fast update

The UltraChip UC8451 provides a fast update mode which allows a quick refresh of the display. The downside of fast updates is that the display is not thoroughly cleared of previous pixels which means that "ghosting" effects can be noticed.

Fast update mode can be enabled or disabled using the routine `GUIDRV_SLinEPD_EnableFastMode()`.

### 11.7.16.2 Supported hardware

#### Controllers

The driver works with the following display controllers:

- Solomon SSD1673, SSD1680
- UltraChip UC8451

#### Bits per pixel

The driver currently supports 1 bpp color depth.

## Interfaces

The driver supports the indirect interface (8 bit) of the display controller. Parallel, 4-pin SPI or I2C bus can be used.

### 11.7.16.3 Color depth and display orientation

The driver can be used with different orientations and 1bpp color depth. Each configuration requires a display driver cache. The following table shows the configuration macros which can be used to create and link the driver during the initialization:

| Identifier            | Color depth | Cache | Orientation                            |
|-----------------------|-------------|-------|--|
| GUIDRV_SLINEPD_1      | 1bpp        | Yes   | default                                |
| GUIDRV_SLINEPD_OY_1   | 1bpp        | Yes   | Y axis mirrored                        |
| GUIDRV_SLINEPD_OX_1   | 1bpp        | Yes   | X axis mirrored                        |
| GUIDRV_SLINEPD_OXY_1  | 1bpp        | Yes   | X and Y axis mirrored                  |
| GUIDRV_SLINEPD_OS_1   | 1bpp        | Yes   | X and Y swapped                        |
| GUIDRV_SLINEPD_OSY_1  | 1bpp        | Yes   | X and Y swapped, Y axis mirrored       |
| GUIDRV_SLINEPD_OSX_1  | 1bpp        | Yes   | X and Y swapped, X axis mirrored       |
| GUIDRV_SLINEPD_OSXY_1 | 1bpp        | Yes   | X and Y swapped, X and Y axis mirrored |

### 11.7.16.4 Driver selection

To use GUIDRV\_SLINEPD for the given display, the following call may be used in the function LCD\_X\_Config:

```
pDevice = GUI_DEVICE_CreateAndLink(GUIDRV_SLINEPD_1, GUICC_1, 0, 0);
```

Detailed information about palette modes can be found in the chapter *Colors* on page 478.

### 11.7.16.5 Display data RAM organization

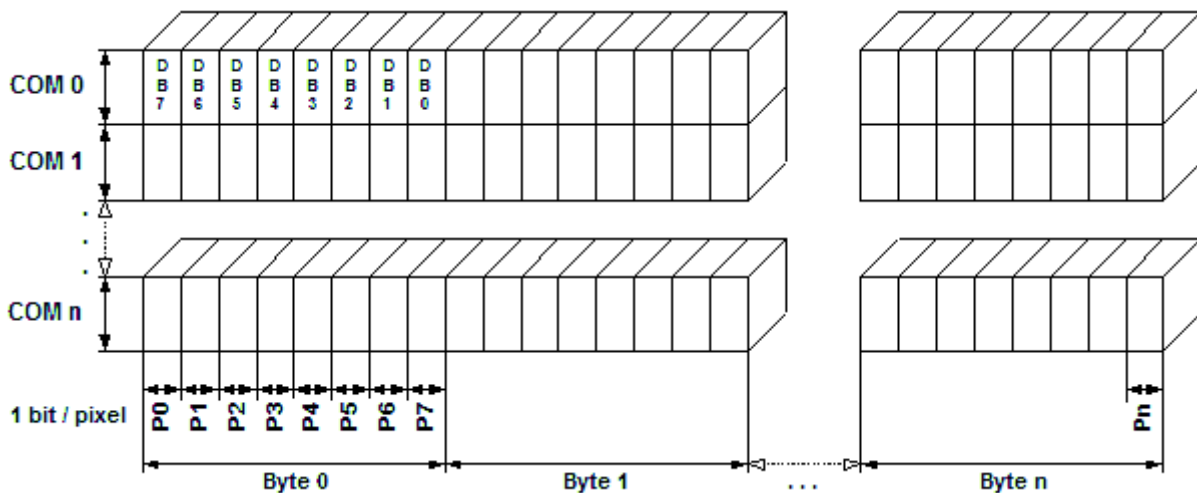

### 11.7.16.6 RAM requirements

This display driver requires a display data cache. The data cache contains a complete copy of the LCD data RAM. The amount of memory used by the cache may be calculated as follows:

```
LCD_PIXELPERBYTE == 8
Size of RAM (in bytes) = ((LCD_XSIZE + (LCD_PIXELPERBYTE - 1)) /
LCD_PIXELPERBYTE) * LCD_YSIZE
```



## UltraChip UC8451

The UltraChip UC8451 in **fast update mode** requires two caches to be present in RAM. To calculate the RAM requirement, the above formula can be doubled.

### 11.7.16.7 Run-time configuration

The table below shows the available run-time configuration routines for this driver:

| Routine   | Description   |
|---|---|
| <code>GUIDRV_SLinEPD_Config()</code>            | Passes a <code>CONFIG_SLINEPD</code> structure to the driver. |
| <code>GUIDRV_SLinEPD_EnableFastMode()</code>    | Enables/disables fast update mode for UC8451.                 |
| <code>GUIDRV_SLinEPD_EnablePartialMode()</code> | Enables/disables partial update mode for SSD1673.             |
| <code>GUIDRV_SLinEPD_SetBus8()</code>           | Sets the interface for the driver.                            |
| <code>GUIDRV_SLinEPD_SetSSD1673()</code>        | Selects SSD1673 to be driven by the driver.                   |
| <code>GUIDRV_SLinEPD_SetUC8451()</code>         | Selects UC8451 to be driven by the driver.                    |

### 11.7.16.7.1 GUIDRV\_SLinEPD\_Config()

#### Description

Passes a CONFIG\_SLINEPD structure to the driver.

#### Prototype

```
void GUIDRV_SLinEPD_Config(GUI_DEVICE      * pDevice,  
                           CONFIG_SLINEPD * pConfig);
```

#### Parameters

| Parameter               | Description  |
|-------------------------|--|
| <a href="#">pDevice</a> | Pointer to the driver device.                          |
| <a href="#">pConfig</a> | Pointer to a CONFIG_SLINEPD structure described below. |

#### Additional information

This driver has an auto update mode. This mode uses a timer which checks periodically if the data in the cache have changed. If this is the reason the timer causes the driver to perform an update of the LCD.

If this function is not called the driver does not use the auto update mode.

### 11.7.16.7.2 GUIDRV\_SLinEPD\_EnableFastMode()

#### Description

Enables fast update mode for the following controllers:

UltraChip  
UC8451

#### Prototype

```
void GUIDRV_SLinEPD_EnableFastMode(int OnOff);
```

#### Parameters

| Parameter | Description                      |
|-----------|----------------------------------|
| OnOff     | 0 for disabling, 1 for enabling. |

#### Additional information

Fast update mode requires a second cache the size of the display. By default, fast update mode is disabled.

### 11.7.16.7.3 GUIDRV\_SLinEPD\_EnablePartialMode()

#### Description

This function enables the partial update mode for the following controllers:

Solomon  
SSD1673

#### Prototype

```
void GUIDRV_SLinEPD_EnablePartialMode(int OnOff);
```

#### Parameters

| Parameter          | Description  |
|--------------------|--|
| <code>OnOff</code> | Enables (1) or disables (0) the partial update mode. |

#### 11.7.16.7.4 GUIDRV\_SLinEPD\_SetBus8()

##### Description

Tells the driver to use the 8 bit indirect interface and passes a pointer to a GUI\_PORT\_API structure to the driver containing function pointers to the hardware routines to be used.

##### Prototype

```
void GUIDRV_SLinEPD_SetBus8(GUI_DEVICE * pDevice,  
                             GUI_PORT_API * pHW_API);
```

##### Parameters

| Parameter               | Description   |
|-------------------------|---|
| <a href="#">pDevice</a> | Pointer to the driver device.                                     |
| <a href="#">pHW_API</a> | Pointer to a GUI_PORT_API structure. See required routines below. |

### 11.7.16.7.5 GUIDRV\_SLinEPD\_SetSSD1673()

#### Description

Configures the driver to use one of the following controllers:

Solomon  
SSD1673

#### Prototype

```
void GUIDRV_SLinEPD_SetSSD1673(GUI_DEVICE * pDevice);
```

#### Parameters

| Parameter            | Description                   |
|----------------------|-------------------------------|
| <code>pDevice</code> | Pointer to the driver device. |

### 11.7.16.7.6 GUIDRV\_SLinEPD\_SetUC8451()

#### Note

When using the UC8451 controller, the cache has to be locked when performing drawing operations using `LCD_ControlCache(LCD_CC_LOCK)` and `LCD_ControlCache(LCD_CC_UNLOCK)`. Unlocking the cache when the drawing operations are finished will result in a flush of the cache to the hardware and an update of the display contents. This only has to be done if the window manager is not used, since the window manager locks and unlocks the cache automatically.

#### Description

Configures the driver to use one of the following controllers:

UltraChip  
8451

#### Prototype

```
void GUIDRV_SLinEPD_SetUC8451(GUI_DEVICE * pDevice);
```

#### Parameters

| Parameter            | Description                   |
|----------------------|-------------------------------|
| <code>pDevice</code> | Pointer to the driver device. |

## 11.7.16.8 Configuration example

```
void LCD_X_Config(void) {
    GUI_DEVICE      * pDevice;
    GUI_PORT_API    PortAPI = {0};
    CONFIG_SLINEPD  Config = {0};
    //
    // Set display driver and color conversion for 1st layer
    //
    pDevice = GUI_DEVICE_CreateAndLink(GUIDRV_SLINEPD_1, GUICC_1, 0, 0);
    //
    // Display driver configuration
    //
    if (LCD_GetSwapXY()) {
        LCD_SetSizeEx (0, YSIZE_PHYS, XSIZE_PHYS);
        LCD_SetVSizeEx(0, YSIZE_PHYS, XSIZE_PHYS);
    } else {
        LCD_SetSizeEx (0, XSIZE_PHYS, YSIZE_PHYS);
        LCD_SetVSizeEx(0, XSIZE_PHYS, YSIZE_PHYS);
    }
    //
    // Choose controller
    //
    GUIDRV_SLinEPD_SetSSD1673(pDevice);
    //
    // Set up port API
    //
    PortAPI.pfWrite8_A0 = _Write8_A0;
    PortAPI.pfWrite8_A1 = _Write8_A1;
    PortAPI.pfWriteM8_A1 = _WriteM8_A1;
    PortAPI.pfRead8_A0  = _Read8_A0;
    GUIDRV_SLinEPD_SetBus8(pDevice, &PortAPI);
    //
    // Auto-Update
    //
    Config.AutoUpdatePeriod = 1000;
    GUIDRV_SLinEPD_Config(pDevice, &Config);
}
```



## 11.7.17 GUIDRV\_SPage

### 11.7.17.1 Supported hardware

#### Controllers

The driver works with the following display controllers:

- Avant Electronics SBN0064G
- Epson S1D15E05, S1D15E06, S1D15605, S1D15606, S1D15607, S1D15608, S1D15705, S1D15710, S1D15714, S1D15719, S1D15721
- Integrated Solutions Technology IST3020, IST3501
- New Japan Radio Company NJU6676
- Novatek NT7502, NT7534, NT7538, NT75451
- Samsung S6B0713, S6B0719, S6B0724, S6B1713
- Sino Wealth SH1101A
- Sitronix ST7522, ST75256, ST75320, ST7565, ST7567, ST7570, ST7591
- Solomon SSD1303, SSD1305, SSD1306, SSD1309, SSD1805, SSD1815
- Sunplus SPLC501C
- UltraChip UC1601, UC1606, UC1608, UC1611, UC1628, UC1638, UC1701

#### Bits per pixel

The driver currently supports 1, 2 and 4 bpp resolutions.

#### Interfaces

The driver supports the indirect interface (8 bit) of the display controller. Parallel, 4-pin SPI or I2C bus can be used.

### 11.7.17.2 Color depth and display orientation

The driver can be used with different orientations and color depths. Each configuration can be used with or without a display driver cache. The following table shows the configuration macros which can be used to create and link the driver during the initialization:

| Identifier            | Color depth | Cache | Orientation                            |
|-----------------------|-------------|-------|--|
| GUIDRV_SPAGE_1C0      | 1bpp        | No    | default                                |
| GUIDRV_SPAGE_OY_1C0   | 1bpp        | No    | Y axis mirrored                        |
| GUIDRV_SPAGE_OX_1C0   | 1bpp        | No    | X axis mirrored                        |
| GUIDRV_SPAGE_OXY_1C0  | 1bpp        | No    | X and Y axis mirrored                  |
| GUIDRV_SPAGE_OS_1C0   | 1bpp        | No    | X and Y swapped                        |
| GUIDRV_SPAGE_OSY_1C0  | 1bpp        | No    | X and Y swapped, Y axis mirrored       |
| GUIDRV_SPAGE_OSX_1C0  | 1bpp        | No    | X and Y swapped, X axis mirrored       |
| GUIDRV_SPAGE_OSXY_1C0 | 1bpp        | No    | X and Y swapped, X and Y axis mirrored |
| GUIDRV_SPAGE_1C1      | 1bpp        | Yes   | default                                |
| GUIDRV_SPAGE_OY_1C1   | 1bpp        | Yes   | Y axis mirrored                        |
| GUIDRV_SPAGE_OX_1C1   | 1bpp        | Yes   | X axis mirrored                        |
| GUIDRV_SPAGE_OXY_1C1  | 1bpp        | Yes   | X and Y axis mirrored                  |
| GUIDRV_SPAGE_OS_1C1   | 1bpp        | Yes   | X and Y swapped                        |
| GUIDRV_SPAGE_OSY_1C1  | 1bpp        | Yes   | X and Y swapped, Y axis mirrored       |
| GUIDRV_SPAGE_OSX_1C1  | 1bpp        | Yes   | X and Y swapped, X axis mirrored       |
| GUIDRV_SPAGE_OSXY_1C1 | 1bpp        | Yes   | X and Y swapped, X and Y axis mirrored |
| GUIDRV_SPAGE_2C0      | 2bpp        | No    | default                                |

| Identifier            | Color depth | Cache | Orientation                            |
|-----------------------|-------------|-------|--|
| GUIDRV_SPAGE_OY_2C0   | 2bpp        | No    | Y axis mirrored                        |
| GUIDRV_SPAGE_OX_2C0   | 2bpp        | No    | X axis mirrored                        |
| GUIDRV_SPAGE_OXY_2C0  | 2bpp        | No    | X and Y axis mirrored                  |
| GUIDRV_SPAGE_OS_2C0   | 2bpp        | No    | X and Y swapped                        |
| GUIDRV_SPAGE_OSY_2C0  | 2bpp        | No    | X and Y swapped, Y axis mirrored       |
| GUIDRV_SPAGE_OSX_2C0  | 2bpp        | No    | X and Y swapped, X axis mirrored       |
| GUIDRV_SPAGE_OSXY_2C0 | 2bpp        | No    | X and Y swapped, X and Y axis mirrored |
| GUIDRV_SPAGE_2C1      | 2bpp        | Yes   | default                                |
| GUIDRV_SPAGE_OY_2C1   | 2bpp        | Yes   | Y axis mirrored                        |
| GUIDRV_SPAGE_OX_2C1   | 2bpp        | Yes   | X axis mirrored                        |
| GUIDRV_SPAGE_OXY_2C1  | 2bpp        | Yes   | X and Y axis mirrored                  |
| GUIDRV_SPAGE_OS_2C1   | 2bpp        | Yes   | X and Y swapped                        |
| GUIDRV_SPAGE_OSY_2C1  | 2bpp        | Yes   | X and Y swapped, Y axis mirrored       |
| GUIDRV_SPAGE_OSX_2C1  | 2bpp        | Yes   | X and Y swapped, X axis mirrored       |
| GUIDRV_SPAGE_OSXY_2C1 | 2bpp        | Yes   | X and Y swapped, X and Y axis mirrored |
| GUIDRV_SPAGE_4C0      | 4bpp        | No    | default                                |
| GUIDRV_SPAGE_OY_4C0   | 4bpp        | No    | Y axis mirrored                        |
| GUIDRV_SPAGE_OX_4C0   | 4bpp        | No    | X axis mirrored                        |
| GUIDRV_SPAGE_OXY_4C0  | 4bpp        | No    | X and Y axis mirrored                  |
| GUIDRV_SPAGE_OS_4C0   | 4bpp        | No    | X and Y swapped                        |
| GUIDRV_SPAGE_OSY_4C0  | 4bpp        | No    | X and Y swapped, Y axis mirrored       |
| GUIDRV_SPAGE_OSX_4C0  | 4bpp        | No    | X and Y swapped, X axis mirrored       |
| GUIDRV_SPAGE_OSXY_4C0 | 4bpp        | No    | X and Y swapped, X and Y axis mirrored |
| GUIDRV_SPAGE_4C1      | 4bpp        | Yes   | default                                |
| GUIDRV_SPAGE_OY_4C1   | 4bpp        | Yes   | Y axis mirrored                        |
| GUIDRV_SPAGE_OX_4C1   | 4bpp        | Yes   | X axis mirrored                        |
| GUIDRV_SPAGE_OXY_4C1  | 4bpp        | Yes   | X and Y axis mirrored                  |
| GUIDRV_SPAGE_OS_4C1   | 4bpp        | Yes   | X and Y swapped                        |
| GUIDRV_SPAGE_OSY_4C1  | 4bpp        | Yes   | X and Y swapped, Y axis mirrored       |
| GUIDRV_SPAGE_OSX_4C1  | 4bpp        | Yes   | X and Y swapped, X axis mirrored       |
| GUIDRV_SPAGE_OSXY_4C1 | 4bpp        | Yes   | X and Y swapped, X and Y axis mirrored |

### Important note for mirroring

As far as we know nearly all supported controllers of this driver support hardware mirroring for X- and Y-axis. If one or both of axis need to be mirrored it is highly recommended to use the hardware commands for mirroring within the initialization sequence of the controller, because software mirroring could cause a negative effect on the performance.

### 11.7.17.3 Driver selection

To use GUIDRV\_SPage for the given display, the following call may be used in the function LCD\_X\_Config:

```
pDevice = GUI_DEVICE_CreateAndLink(GUIDRV_SPAGE_4C0, GUICC_4, 0, 0);
```

Detailed information about palette modes can be found in the chapter *Colors* on page 478.

### 11.7.17.4 Display data RAM organization

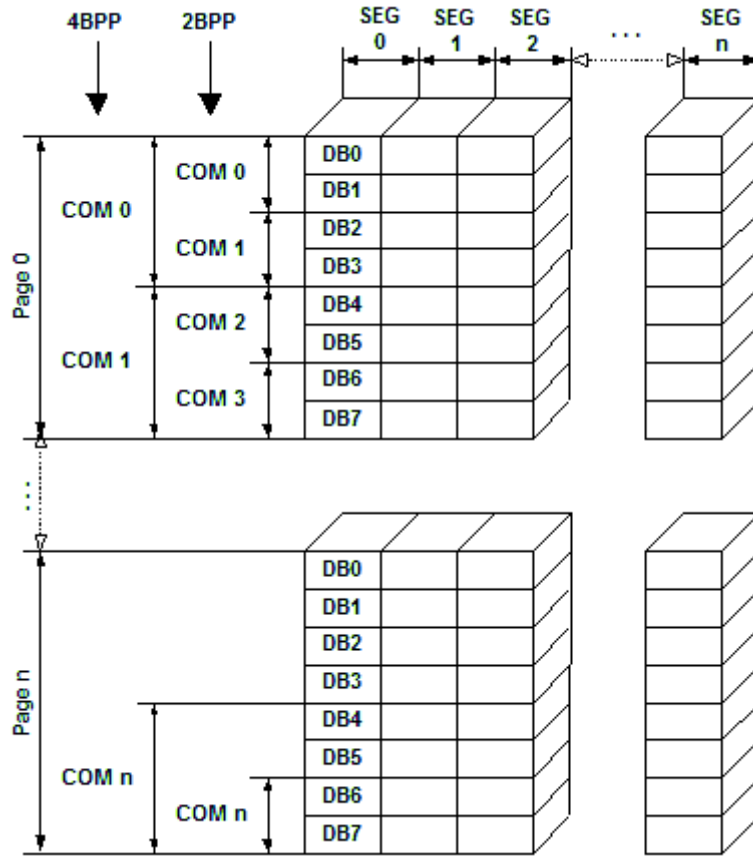

The picture above shows the relation between the display memory and the SEG and COM lines of the display.

### 11.7.17.5 RAM requirements

This display driver can be used with or without a display data cache. The data cache contains a complete copy of the LCD data RAM. If no cache is used, there are no additional RAM requirements.

It is highly recommended to use this driver with a data cache for faster LCD-access. Not using a cache degrades the performance of this driver seriously. The amount of memory used by the cache may be calculated as follows:

$$\text{Size of RAM (in bytes)} = (\text{LCD\_YSIZE} + (8 / \text{LCD\_BITSPERPIXEL} - 1)) / 8 * \text{LCD\_BITSPERPIXEL} * \text{LCD\_XSIZE}$$

### 11.7.17.6 Run-time configuration

The table below shows the available run-time configuration routines for this driver:

| Routine                             | Description  |
|-------------------------------------|--|
| <code>GUIDRV_SPage_Config()</code>  | Passes a pointer to a <code>CONFIG_SPAGE</code> structure.   |
| <code>GUIDRV_SPage_SetBus8()</code> | Configures the driver to use the 8 bit indirect interface and passes a pointer to a <code>GUI_PORT_API</code> structure to the driver. |

| Routine                                | Description   |
|--|---|
| <code>GUIDRV_SPage_Set1502()</code>    | Set up the driver to use one of the following controllers: <ul style="list-style-type: none"> <li>• Avant Electronics SBN0064G</li> <li>• Hitachi HD61202</li> <li>• S6B0108 (KS0108)</li> </ul>  |
| <code>GUIDRV_SPage_Set1510()</code>    | Set up the driver to use one of the following controllers: <ul style="list-style-type: none"> <li>• Epson S1D15605, S1D15606, S1D15607, S1D15608, S1D15705, S1D15710, S1D15714</li> <li>• Integrated Solutions Technology IST3020</li> <li>• New Japan Radio Company NJU6676</li> <li>• Novatek NT7502, NT7534, NT7538, NT75451</li> <li>• OriseTech SPLC502B</li> <li>• Samsung S6B0713, S6B0719, S6B0724, S6B1713</li> <li>• Sino Wealth SH1101A</li> <li>• Sitronix ST7522, ST7565, ST7567, ST7570, ST7571</li> <li>• Solomon SSD1303, SSD1305, SSD1805, SSD1815, SSD1821</li> <li>• Sunplus SPLC501C</li> <li>• UltraChip UC1601, UC1606, UC1608, UC1701</li> </ul> |
| <code>GUIDRV_SPage_Set1512()</code>    | Set up the driver to use one of the following controllers: <ul style="list-style-type: none"> <li>• Epson S1D15E05, S1D15E06, S1D15719, S1D15721</li> <li>• Integrated Solutions Technology IST3501</li> </ul>  |
| <code>GUIDRV_SPage_SetST75256()</code> | Set up the driver to use the following controllers: <ul style="list-style-type: none"> <li>• Sitronix ST75256, ST75160</li> </ul>   |
| <code>GUIDRV_SPage_SetST75320()</code> | Set up the driver to use the following controller: <ul style="list-style-type: none"> <li>• Sitronix ST75320</li> <li>• Sitronix ST7592</li> </ul>  |
| <code>GUIDRV_SPage_SetST7591()</code>  | Set up the driver to use the following controller: <ul style="list-style-type: none"> <li>• Sitronix ST7591</li> </ul>  |
| <code>GUIDRV_SPage_SetUC1610()</code>  | Set up the driver to use the following controller: <ul style="list-style-type: none"> <li>• UltraChip UC1610</li> </ul>   |
| <code>GUIDRV_SPage_SetUC1611()</code>  | Set up the driver to use the following controller: <ul style="list-style-type: none"> <li>• UltraChip UC1611</li> </ul>   |
| <code>GUIDRV_SPage_SetUC1628()</code>  | Set up the driver to use the following controller: <ul style="list-style-type: none"> <li>• UltraChip UC1628</li> </ul>   |
| <code>GUIDRV_SPage_SetUC1638()</code>  | Set up the driver to use the following controller: <ul style="list-style-type: none"> <li>• UltraChip UC1638</li> </ul>   |

### 11.7.17.6.1 GUIDRV\_SPage\_Config()

#### Description

Passes a pointer to a `CONFIG_SPAGE` structure to the driver.

#### Prototype

```
void GUIDRV_SPage_Config(GUI_DEVICE * pDevice,
                        CONFIG_SPAGE * pConfig);
```

#### Parameters

| Parameter            | Description   |
|----------------------|---|
| <code>pDevice</code> | Pointer to the driver device.                                     |
| <code>pConfig</code> | Pointer to a <code>CONFIG_SPAGE</code> structure described below. |

#### Elements of structure `CONFIG_SPAGE`

| Data type        | Element               | Description  |
|------------------|-----------------------|--|
| <code>int</code> | <code>FirstSEG</code> | First segment address to be used in the data RAM of the display controller. The value can be determined experimentally or taken from the display documentation. The value is normally 0. |
| <code>int</code> | <code>FirstCOM</code> | First common address to be used in the data RAM of the display controller. The value can be determined experimentally or taken from the display documentation. The value is normally 0.  |

### 11.7.17.6.2 GUIDRV\_SPage\_SetBus8()

#### Description

Tells the driver to use the 8 bit indirect interface and passes a pointer to a GUI\_PORT\_API structure to the driver containing function pointers to the hardware routines to be used.

#### Prototype

```
void GUIDRV_SPage_SetBus8(GUI_DEVICE * pDevice,
                          GUI_PORT_API * pHW_API);
```

#### Parameters

| Parameter            | Description   |
|----------------------|---|
| <code>pDevice</code> | Pointer to the driver device.                                     |
| <code>pHW_API</code> | Pointer to a GUI_PORT_API structure. See required routines below. |

#### Required GUI\_PORT\_API routines

| Element                   | Data type                                       |
|---------------------------|---|
| <code>pfWrite8_A0</code>  | <code>void (*)(U8 Data)</code>                  |
| <code>pfWrite8_A1</code>  | <code>void (*)(U8 Data)</code>                  |
| <code>pfWriteM8_A1</code> | <code>void (*)(U8 * pData, int NumItems)</code> |
| <code>pfRead8_A1</code>   | <code>U8 (*)(void)</code>                       |

### 11.7.17.6.3 GUIDRV\_SPage\_Set1502()

#### Description

Configures the driver to use one of the following controllers:

- Avant Electronics SBN0064G
- Hitachi HD61202
- Samsung S6B0108, KS0108

#### Prototype

```
void GUIDRV_SPage_Set1502(GUI_DEVICE * pDevice);
```

#### Parameters

| Parameter            | Description                   |
|----------------------|-------------------------------|
| <code>pDevice</code> | Pointer to the driver device. |

#### 11.7.17.6.4 GUIDRV\_SPage\_Set1510()

##### Description

Configures the driver to use one of the following controllers:

- Epson S1D15605, S1D15606, S1D15607, S1D15608, S1D15705, S1D15710, S1D15714
- Integrated Solutions Technology IST3020
- New Japan Radio Company NJU6676
- Novatek NT7502, NT7534, NT7538, NT75451
- Samsung S6B0713, S6B0719, S6B0724, S6B1713
- Sino Wealth SH1101A
- Sitronix ST7522, ST7565, ST7567, ST7570, ST7571
- Solomon SSD1303, SSD1305, SSD1306, SSD1309, SSD1805, SSD1815, SSD1821
- Sunplus SPLC501C
- UltraChip UC1601, UC1606, UC1608, UC1701

##### Prototype

```
void GUIDRV_SPage_Set1510(GUI_DEVICE * pDevice);
```

##### Parameters

| Parameter            | Description                   |
|----------------------|-------------------------------|
| <code>pDevice</code> | Pointer to the driver device. |



### 11.7.17.6.5 GUIDRV\_SPage\_Set1512()

#### Description

Configures the driver to use one of the following controllers:

- Epson S1D15E05, S1D15E06, S1D15719, S1D15721

#### Prototype

```
void GUIDRV_SPage_Set1512(GUI_DEVICE * pDevice);
```

#### Parameters

| Parameter            | Description                   |
|----------------------|-------------------------------|
| <code>pDevice</code> | Pointer to the driver device. |

### 11.7.17.6.6 GUIDRV\_SPage\_SetST75256()

#### Description

Configures the driver to use the Sitronix ST75256 controller.

#### Prototype

```
void GUIDRV_SPage_SetST75256(GUI_DEVICE * pDevice);
```

#### Parameters

| Parameter            | Description                   |
|----------------------|-------------------------------|
| <code>pDevice</code> | Pointer to the driver device. |

### 11.7.17.6.7 GUIDRV\_SPage\_SetST75320()

#### Description

Configures the driver to use the Sitronix ST75320 controller.

#### Prototype

```
void GUIDRV_SPage_SetST75320(GUI_DEVICE * pDevice);
```

#### Parameters

| Parameter            | Description                   |
|----------------------|-------------------------------|
| <code>pDevice</code> | Pointer to the driver device. |

### 11.7.17.6.8 GUIDRV\_SPage\_SetST7591()

#### Description

Configures the driver to use the Sitronix ST7591 controller.

#### Prototype

```
void GUIDRV_SPage_SetST7591(GUI_DEVICE * pDevice);
```

#### Parameters

| Parameter            | Description                   |
|----------------------|-------------------------------|
| <code>pDevice</code> | Pointer to the driver device. |

### 11.7.17.6.9 GUIDRV\_SPage\_SetUC1610()

#### Description

Configures the driver use to the UltraChip UC1610 controller.

#### Prototype

```
void GUIDRV_SPage_SetUC1610(GUI_DEVICE * pDevice);
```

#### Parameters

| Parameter            | Description                   |
|----------------------|-------------------------------|
| <code>pDevice</code> | Pointer to the driver device. |

### 11.7.17.6.10 GUIDRV\_SPage\_SetUC1611()

#### Description

Configures the driver use to the UltraChip UC1611 controller.

#### Prototype

```
void GUIDRV_SPage_SetUC1611(GUI_DEVICE * pDevice);
```

#### Parameters

| Parameter            | Description                   |
|----------------------|-------------------------------|
| <code>pDevice</code> | Pointer to the driver device. |

### 11.7.17.6.11 GUIDRV\_SPage\_SetUC1628()

#### Description

Configures the driver use to the UltraChip UC1628 controller.

#### Prototype

```
void GUIDRV_SPage_SetUC1628(GUI_DEVICE * pDevice);
```

#### Parameters

| Parameter            | Description                   |
|----------------------|-------------------------------|
| <code>pDevice</code> | Pointer to the driver device. |

### 11.7.17.6.12 GUIDRV\_SPage\_SetUC1638()

#### Description

Configures the driver use to the UltraChip UC1638 controller.

#### Prototype

```
void GUIDRV_SPage_SetUC1638(GUI_DEVICE * pDevice);
```

#### Parameters

| Parameter            | Description                   |
|----------------------|-------------------------------|
| <code>pDevice</code> | Pointer to the driver device. |



### 11.7.17.7 Configuration Example

```
void LCD_X_Config(void) {
    GUI_PORT_API    PortAPI = {0};
    CONFIG_SPAGE    Config = {0};
    GUI_DEVICE      * pDevice;
    //
    // Set display driver and color conversion for 1st layer
    //
    pDevice = GUI_DEVICE_CreateAndLink(DISPLAY_DRIVER, COLOR_CONVERSION, 0, 0);
    //
    // Display size configuration
    //
    if (LCD_GetSwapXY()) {
        LCD_SetSizeEx (0, YSIZE_PHYS,  XSIZE_PHYS);
        LCD_SetVSizeEx(0, VYSIZE_PHYS, VXSIZE_PHYS);
    } else {
        LCD_SetSizeEx (0, XSIZE_PHYS,  YSIZE_PHYS);
        LCD_SetVSizeEx(0, VXSIZE_PHYS, VYSIZE_PHYS);
    }
    //
    // Driver configuration
    //
    Config.FirstSEG = 0;//256 - 224;
    GUIDRV_SPage_Config(pDevice, &Config);
    //
    // Configure hardware routines
    //
    PortAPI.pfWrite8_A0 = _Write8_A0;
    PortAPI.pfWrite8_A1 = _Write8_A1;
    PortAPI.pfWriteM8_A1 = _WriteM8_A1;
    PortAPI.pfReadM8_A1  = LCD_X_8080_8_ReadM01;
    GUIDRV_SPage_SetBus8(pDevice, &PortAPI);
    //
    // Controller configuration
    //
    GUIDRV_SPage_SetUC1611(pDevice);
}
```

## 11.7.18 GUIDRV\_SSD1322

### 11.7.18.1 Supported hardware

#### Controllers

The driver works with the following display controllers:

- Solomon SSD1322

#### Bits per pixel

The driver currently supports 4 bpp color depth.

#### Interfaces

The driver supports the indirect interface (8 bit) of the display controller.

### 11.7.18.2 Driver selection

To use GUIDRV\_SSD1322 for the given display, the following command can be used e.g.:

```
pDevice = GUI_DEVICE_CreateAndLink(GUIDRV_SSD1322, GUICC_4, 0, 0);
```

Detailed information about palette modes can be found in the chapter *Colors* on page 478.

### 11.7.18.3 Display data RAM organization

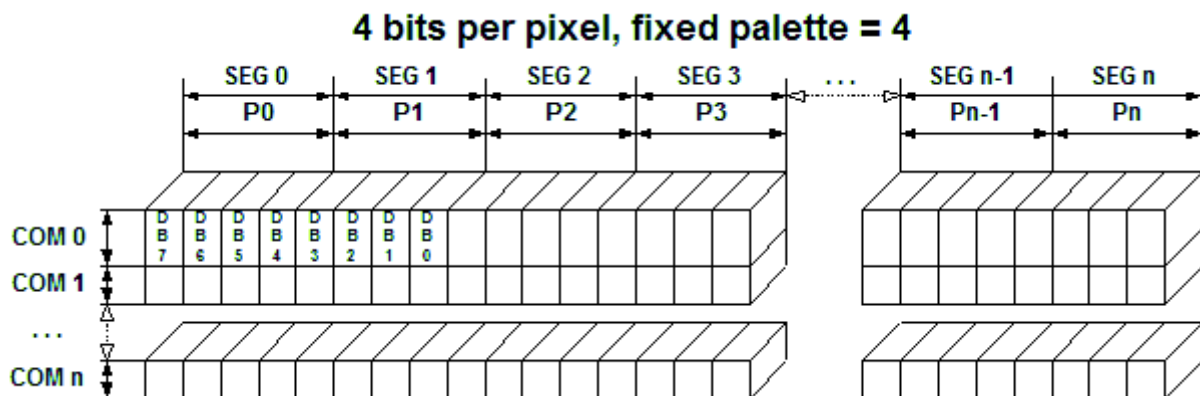

### 11.7.18.4 RAM requirements

This display driver requires a display data cache, containing a complete copy of the LCD data RAM. The amount of memory used by the cache may be calculated as follows:

```
Size of RAM (in bytes) = ((LCD_XSIZE + 1) / 2) \times LCD_YSIZE
```

### 11.7.18.5 Run-time configuration

The table below shows the available run-time configuration routines of this driver:

| Routine                               | Description  |
|---------------------------------------|--|
| <code>GUIDRV_SSD1322_Config()</code>  | Passes a pointer to a <code>CONFIG_SSD1322</code> structure to the driver.   |
| <code>GUIDRV_SSD1322_SetBus8()</code> | Tells the driver to use the 8 bit indirect interface and passes a pointer to a <code>GUI_PORT_API</code> structure to the driver containing function pointers to the hardware routines to be used. |

### 11.7.18.5.1 GUIDRV\_SSD1322\_Config()

#### Description

Passes a pointer to a CONFIG\_SSD1322 structure to the driver.

#### Prototype

```
void GUIDRV_SSD1322_Config(GUI_DEVICE      * pDevice,
                           CONFIG_SSD1322 * pConfig);
```

#### Parameters

| Parameter            | Description  |
|----------------------|--|
| <code>pDevice</code> | Pointer to the driver device.                          |
| <code>pConfig</code> | Pointer to a CONFIG_SSD1322 structure described below. |

#### Elements of structure CONFIG\_SSD1322

| Data type | Element  | Description  |
|-----------|----------|--|
| int       | FirstSEG | First segment address to be used in the data RAM of the display controller. The value can be determined experimentally or taken from the display documentation. The value is normally 0. |
| int       | FirstCOM | First common address to be used in the data RAM of the display controller. The value can be determined experimentally or taken from the display documentation. The value is normally 0.  |

### 11.7.18.5.2 GUIDRV\_SSD1322\_SetBus8()

#### Description

Tells the driver to use the 8 bit indirect interface and passes a pointer to a GUI\_PORT\_API structure to the driver containing function pointers to the hardware routines to be used.

#### Prototype

```
void GUIDRV_SSD1322_SetBus8(GUI_DEVICE * pDevice,  
                             GUI_PORT_API * pHW_API);
```

#### Parameters

| Parameter               | Description   |
|-------------------------|---|
| <a href="#">pDevice</a> | Pointer to the driver device.                                     |
| <a href="#">pHW_API</a> | Pointer to a GUI_PORT_API structure. See required routines below. |

### 11.7.18.6 Required GUI\_PORT\_API routines

| Data type  | Element                   | Description  |
|--|---------------------------|--|
| <code>void (*)(U8 Data);</code>                  | <code>pfWrite8_A0</code>  | Pointer to a function which writes one byte to the controller with C/D line low.         |
| <code>void (*)(U8 Data);</code>                  | <code>pfWrite8_A1</code>  | Pointer to a function which writes one byte to the controller with C/D line high.        |
| <code>void (*)(U8 * pData, int NumItems);</code> | <code>pfWriteM8_A1</code> | Pointer to a function which writes multiple bytes to the controller with C/D line high.  |
| <code>U8 (*)(void);</code>                       | <code>pfRead8_A1</code>   | Pointer to a function which reads one byte from the controller with C/D line high.       |
| <code>void (*)(U8 * pData, int NumItems);</code> | <code>pfReadM8_A1</code>  | Pointer to a function which reads multiple bytes from the controller with C/D line high. |

### 11.7.18.7 Configuration example

```

void LCD_X_Config(void) {
    CONFIG_SSD1322    Config = {0};
    GUI_DEVICE        * pDevice;
    GUI_PORT_API      PortAPI = {0};
    //
    // Set display driver and color conversion for 1st layer
    //
    pDevice = GUI_DEVICE_CreateAndLink(DISPLAY_DRIVER, COLOR_CONVERSION, 0, 0);
    //
    // Display size configuration
    //
    if (LCD_GetSwapXY()) {
        LCD_SetSizeEx (0, YSIZE_PHYS,  XSIZE_PHYS);
        LCD_SetVSizeEx(0, VYSIZE_PHYS, VXSIZE_PHYS);
    } else {
        LCD_SetSizeEx (0, XSIZE_PHYS,  YSIZE_PHYS);
        LCD_SetVSizeEx(0, VXSIZE_PHYS, VYSIZE_PHYS);
    }
    //
    // Driver configuration
    //
    Config.FirstSEG = 112;
    GUIDRV_SSD1322_Config(pDevice, &Config);
    //
    // Configure hardware routines
    //
    PortAPI.pfWrite8_A0 = LCD_X_SPI4_Write0;
    PortAPI.pfWrite8_A1 = LCD_X_SPI4_Write1;
    PortAPI.pfWriteM8_A1 = LCD_X_SPI4_WriteM1;
    PortAPI.pfRead8_A1  = LCD_X_SPI4_Read1;
    PortAPI.pfReadM8_A1 = LCD_X_SPI4_ReadM1;
    GUIDRV_SSD1322_SetBus8(pDevice, &PortAPI);
}

```

## 11.7.19 GUIDRV\_SSD1926

### 11.7.19.1 Supported hardware

#### Controllers

This driver works with the Solomon SSD1926 display controller.

#### Bits per pixel

Currently supported color depth is 8. The display controller supports up to 32 bits per pixel. The driver can be extended on demand if support for an other color depth is required.

#### Interfaces

The driver supports the 16 bit indirect interface.

### 11.7.19.2 Color depth and display orientation

This driver can be used with different orientations. The following table shows the configuration macros which can be used to create and link the driver during the initialization:

| Identifier            | Color depth and orientation                  |
|-----------------------|--|
| GUIDRV_SSD1926_8      | 8bpp, default orientation                    |
| GUIDRV_SSD1926_OY_8   | 8bpp, Y axis mirrored                        |
| GUIDRV_SSD1926_OX_8   | 8bpp, X axis mirrored                        |
| GUIDRV_SSD1926_OXY_8  | 8bpp, X and Y axis mirrored                  |
| GUIDRV_SSD1926_OS_8   | 8bpp, X and Y swapped                        |
| GUIDRV_SSD1926_OSY_8  | 8bpp, X and Y swapped, Y axis mirrored       |
| GUIDRV_SSD1926_OSX_8  | 8bpp, X and Y swapped, X axis mirrored       |
| GUIDRV_SSD1926_OSXY_8 | 8bpp, X and Y swapped, X and Y axis mirrored |

### 11.7.19.3 Driver selection

To use GUIDRV\_SSD1926 for the given display, the following command can be used e.g.:

```
pDevice = GUI_DEVICE_CreateAndLink(GUIDRV_SSD1926, GUICC_323, 0, 0);
```

Detailed information about palette modes can be found in the chapter *Colors* on page 478.

### 11.7.19.4 Display data RAM organization

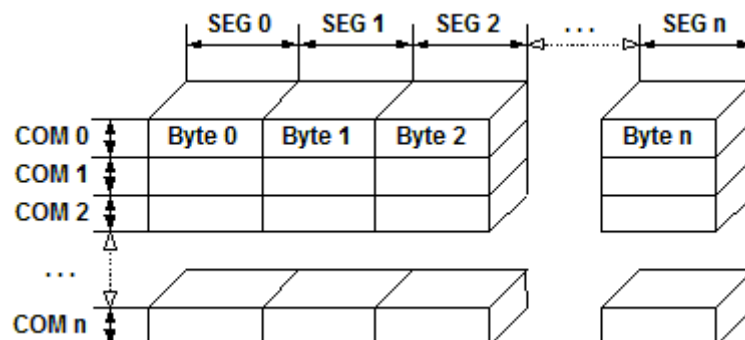

The picture above shows the relation between the display memory and the SEG and COM lines of the display.

### 11.7.19.5 RAM requirements

This display driver may be used with or without a display data cache, containing a complete copy of the LCD data RAM. If no cache is used, there are no additional RAM requirements. It is recommended to use this driver with a data cache for faster LCD-access. The amount of memory used by the cache may be calculated as follows:

```
Size of RAM (in bytes) = LCD_XSIZE \times LCD_YSIZE
```

### 11.7.19.6 Run-time configuration

The table below shows the available run-time configuration routines of this driver:

| Routine                                | Description   |
|--|---|
| <code>GUIDRV_SSD1926_Config()</code>   | Passes a pointer to a <code>CONFIG_SSD1926</code> structure to the driver.  |
| <code>GUIDRV_SSD1926_SetBus16()</code> | Tells the driver to use the 16 bit indirect interface and passes a pointer to a <code>GUI_PORT_API</code> structure to the driver containing function pointers to the hardware routines to be used. |

### 11.7.19.6.1 GUIDRV\_SSD1926\_Config()

#### Description

Passes a pointer to a CONFIG\_SSD1926 structure to the driver.

#### Prototype

```
void GUIDRV_SSD1926_Config(GUI_DEVICE * pDevice,
                           CONFIG_SSD1926 * pConfig);
```

#### Parameters

| Parameter            | Description  |
|----------------------|--|
| <code>pDevice</code> | Pointer to the driver device.                          |
| <code>pConfig</code> | Pointer to a CONFIG_SSD1926 structure described below. |

#### Elements of structure CONFIG\_SSD1926

| Data type | Element  | Description  |
|-----------|----------|--|
| int       | FirstSEG | First segment address to be used in the data RAM of the display controller. The value can be determined experimentally or taken from the display documentation. The value is normally 0. |
| int       | FirstCOM | First common address to be used in the data RAM of the display controller. The value can be determined experimentally or taken from the display documentation. The value is normally 0.  |
| int       | UseCache | Enables or disables use of a data cache. Should be set to 1 for enabling and to 0 for disabling.   |



### 11.7.19.6.2 GUIDRV\_SSD1926\_SetBus16()

#### Description

Tells the driver to use the 16 bit indirect interface and passes a pointer to a GUI\_PORT\_API structure to the driver containing function pointers to the hardware routines to be used.

#### Prototype

```
void GUIDRV_SSD1926_SetBus16(GUI_DEVICE * pDevice,
                             GUI_PORT_API * pHW_API);
```

#### Parameters

| Parameter            | Description   |
|----------------------|---|
| <code>pDevice</code> | Pointer to the driver device.                                     |
| <code>pHW_API</code> | Pointer to a GUI_PORT_API structure. See required routines below. |

### 11.7.19.7 Required GUI\_PORT\_API routines

| Data type  | Element                    | Description   |
|--|----------------------------|---|
| <code>void (*)(U16 Data)</code>                  | <code>pfWrite16_A0</code>  | Pointer to a function which writes one word to the controller with C/D line low.        |
| <code>void (*)(U16 Data)</code>                  | <code>pfWrite16_A1</code>  | Pointer to a function which writes one word to the controller with C/D line high.       |
| <code>void (*)(U16 * pData, int NumItems)</code> | <code>pfWriteM16_A0</code> | Pointer to a function which writes multiple words to the controller with C/D line low.  |
| <code>void (*)(U16 * pData, int NumItems)</code> | <code>pfWriteM16_A1</code> | Pointer to a function which writes multiple words to the controller with C/D line high. |
| <code>U16 (*)(void)</code>                       | <code>pfRead16_A1</code>   | Pointer to a function which reads one word from the controller with C/D line high.      |

### 11.7.19.8 Configuration Example

```
#define XSIZE 320L
#define YSIZE 240L
GUI_PORT_API _PortAPI;
void LCD_X_Config(void) {
    GUI_DEVICE * pDevice_0;
    CONFIG_SSD1926 Config_0 = {0};
    //
    // Set display driver and color conversion
    //
    pDevice_0 = GUI_DEVICE_CreateAndLink(GUIDRV_SSD1926_8, GUICC_8666, 0, 0);
    //
    // Common display driver configuration
    //
    LCD_SetSizeEx (0, XSIZE, YSIZE);
    LCD_SetVSizeEx(0, XSIZE, YSIZE);
    //
    // Set driver specific configuration items
    //
    Config_0.UseCache = 1;
    //
    // Set hardware access routines
    //
    _PortAPI.pfWrite16_A0 = LCD_X_8080_16_Write00_16;
    _PortAPI.pfWrite16_A1 = LCD_X_8080_16_Write01_16;
    _PortAPI.pfWriteM16_A0 = LCD_X_8080_16_WriteM00_16;
    _PortAPI.pfWriteM16_A1 = LCD_X_8080_16_WriteM01_16;
```

```
_PortAPI.pfRead16_A1 = LCD_X_8080_16_Read01_16;  
GUIDRV_SSD1926_SetBus16(pDevice, &_PortAPI);  
//  
// Pass configuration structure to driver  
//  
GUIDRV_SSD1926_Config(pDevice, &Config_0);  
}
```

## 11.7.20 GUIDRV\_UC1698G

### 11.7.20.1 Supported Hardware

#### Controllers

This driver has been tested with the UltraChip UC1698G.

#### Bits per pixel

5 bpp grayscales.

#### Interfaces

The driver supports the 8- and 16-bit indirect interface.

### 11.7.20.2 Color depth and display orientation

The driver consists of several files. They are named `_[O]_[BPP]C[CACHE].c`. The `[O]` is optional and stands for the desired display orientation. `[BPP]` means the color depth to use and `[CACHE]` is defined with 1 to use a cache and 0 to work without cache. The following table shows the driver files and the configuration macros which should be used to create and link the driver during the initialization:

| Identifier              | Color depth and orientation                                  |
|-------------------------|--|
| GUIDRV_UC1698G_5C0      | 5bpp, no cache, default orientation.                         |
| GUIDRV_UC1698G_OY_5C0   | 5bpp, no cache, Y axis mirrored.                             |
| GUIDRV_UC1698G_OX_5C0   | 5bpp, no cache, X axis mirrored.                             |
| GUIDRV_UC1698G_OXY_5C0  | 5bpp, no cache, Y and X axis mirrored.                       |
| GUIDRV_UC1698G_OS_5C0   | 5bpp, no cache, X and Y axis swapped.                        |
| GUIDRV_UC1698G_OSY_5C0  | 5bpp, no cache, Y axis mirrored, X and Y axis swapped.       |
| GUIDRV_UC1698G_OSX_5C0  | 5bpp, no cache, X axis mirrored, X and Y axis swapped.       |
| GUIDRV_UC1698G_OSXY_5C0 | 5bpp, no cache, X and Y axis mirrored, X and Y axis swapped. |
| GUIDRV_UC1698G_5C1      | 5bpp, cache, default orientation.                            |
| GUIDRV_UC1698G_OY_5C1   | 5bpp, cache, Y axis mirrored.                                |
| GUIDRV_UC1698G_OX_5C1   | 5bpp, cache, X axis mirrored.                                |
| GUIDRV_UC1698G_OXY_5C1  | 5bpp, cache, Y and X axis mirrored.                          |
| GUIDRV_UC1698G_OS_5C1   | 5bpp, cache, X and Y axis swapped.                           |
| GUIDRV_UC1698G_OSY_5C1  | 5bpp, cache, Y axis mirrored, X and Y axis swapped.          |
| GUIDRV_UC1698G_OSX_5C1  | 5bpp, cache, X axis mirrored, X and Y axis swapped.          |
| GUIDRV_UC1698G_OSXY_5C1 | 5bpp, cache, X and Y axis mirrored, X and Y axis swapped.    |

### 11.7.20.3 Driver selection

To use for the given display, the following command can be used e.g.:

```
pDevice = GUI_DEVICE_CreateAndLink(GUIDRV_UC1698G_5C1, GUICC_5, 0, 0);
```

Detailed information about palette modes can be found in the chapter *Colors* on page 478.

### 11.7.20.4 Display data RAM organization

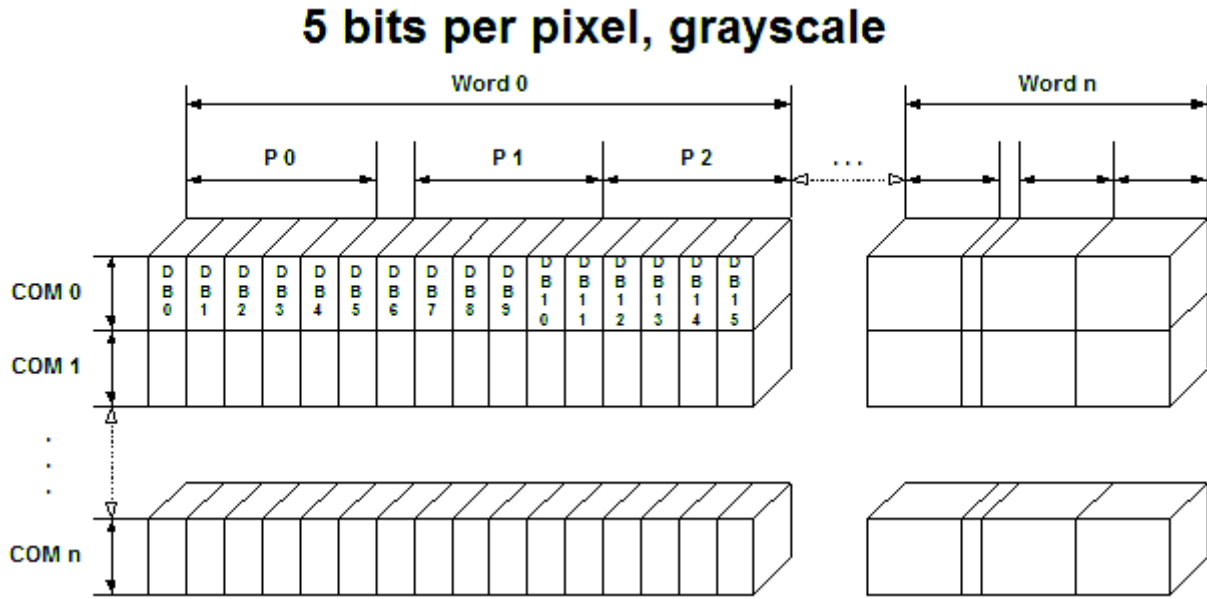

The picture above shows the relation between the display memory and the pixels of the LCD in terms of the color depth.

### 11.7.20.5 RAM requirements

This display driver requires approx. 500 Bytes to work. It can also be used with and without a display data cache, containing a complete copy of the content of the display data RAM. The amount of memory used by the cache is:

$$(LCD\_XSIZE + 2) / 3 * LCD\_YSIZE * 2$$

Using a cache avoids reading operations from the display controller in case of XOR drawing operations and further it speeds up string output operations.

### 11.7.20.6 Run-time configuration

The table below shows the available run-time configuration routines of this driver:

| Routine                                | Description  |
|--|--|
| <code>GUIDRV_UC1698G_Config()</code>   | Passes a pointer to a <code>CONFIG_UC1698G</code> structure to the driver.   |
| <code>GUIDRV_UC1698G_SetBus8()</code>  | Tells the driver to use the 8 bit indirect interface and passes pointer to a <code>GUI_PORT_API</code> structure to the driver.  |
| <code>GUIDRV_UC1698G_SetBus16()</code> | Tells the driver to use the 16 bit indirect interface and passes pointer to a <code>GUI_PORT_API</code> structure to the driver. |

### 11.7.20.6.1 GUIDRV\_UC1698G\_Config()

#### Description

Configures the driver to work according to the passed CONFIG\_UC1698G structure.

#### Prototype

```
void GUIDRV_UC1698G_Config(GUI_DEVICE * pDevice,
                           CONFIG_UC1698G * pConfig);
```

#### Parameters

| Parameter            | Description  |
|----------------------|--|
| <code>pDevice</code> | Pointer to the driver device.                          |
| <code>pConfig</code> | Pointer to a CONFIG_UC1698G structure described below. |

#### Elements of structure CONFIG\_UC1698G

| Data type | Element       | Description  |
|-----------|---------------|--|
| int       | FirstSEG      | First segment address to be used in the data RAM of the display controller. The value can be determined experimentally or taken from the display documentation. The value is normally 0. |
| int       | FirstCOM      | First common address to be used in the data RAM of the display controller. The value can be determined experimentally or taken from the display documentation. The value is normally 0.  |
| int       | NumDummyReads | Number of dummy reads to do before the actual read operation.  |

### 11.7.20.6.2 GUIDRV\_UC1698G\_SetBus8()

#### Description

Tells the driver to use the 8 bit indirect interface and passes a pointer to a GUI\_PORT\_API structure to the driver containing function pointers to the hardware routines to be used.

#### Prototype

```
void GUIDRV_UC1698G_SetBus8(GUI_DEVICE * pDevice,  
                             GUI_PORT_API * pHW_API);
```

#### Parameters

| Parameter               | Description  |
|-------------------------|--|
| <a href="#">pDevice</a> | Pointer to the driver device.  |
| <a href="#">pHW_API</a> | Pointer to a GUI_PORT_API structure. The required routines are listed below. |

### 11.7.20.6.3 GUIDRV\_UC1698G\_SetBus16()

#### Description

Tells the driver to use the 16 bit indirect interface and passes a pointer to a GUI\_PORT\_API structure to the driver containing function pointers to the hardware routines to be used.

#### Prototype

```
void GUIDRV_UC1698G_SetBus16(GUI_DEVICE * pDevice,  
                             GUI_PORT_API * pHW_API);
```

#### Parameters

| Parameter               | Description  |
|-------------------------|--|
| <a href="#">pDevice</a> | Pointer to the driver device.  |
| <a href="#">pHW_API</a> | Pointer to a GUI_PORT_API structure. The required routines are listed below. |

### 11.7.20.7 Required GUI\_PORT\_API routines

The required GUI\_PORT\_API routines depend on the used interface. If a cache is used the routines for reading data are unnecessary for each interface:

#### 8 bit interface

| Data type  | Element                      | Description  |
|--|------------------------------|--|
| <code>void (*)(U8 Data);</code>                  | <a href="#">pfWrite8_A0</a>  | Pointer to a function which writes one byte to the controller with C/D line low.         |
| <code>void (*)(U8 Data);</code>                  | <a href="#">pfWrite8_A1</a>  | Pointer to a function which writes one byte to the controller with C/D line high.        |
| <code>void (*)(U8 * pData, int NumItems);</code> | <a href="#">pfWriteM8_A0</a> | Pointer to a function which writes multiple bytes to the controller with C/D line low.   |
| <code>void (*)(U8 * pData, int NumItems);</code> | <a href="#">pfWriteM8_A1</a> | Pointer to a function which writes multiple bytes to the controller with C/D line high.  |
| <code>U8 (*)(void);</code>                       | <a href="#">pfRead8_A0</a>   | Pointer to a function which reads one byte from the controller with C/D line low.        |
| <code>U8 (*)(void);</code>                       | <a href="#">pfRead8_A1</a>   | Pointer to a function which reads one byte from the controller with C/D line high.       |
| <code>void (*)(U8 * pData, int NumItems);</code> | <a href="#">pfReadM8_A1</a>  | Pointer to a function which reads multiple bytes from the controller with C/D line high. |

#### 16 bit interface

| Data type   | Element                       | Description  |
|---|-------------------------------|--|
| <code>void (*)(U16 Data);</code>                  | <a href="#">pfWrite16_A0</a>  | Pointer to a function which writes one word to the controller with C/D line low.         |
| <code>void (*)(U16 Data);</code>                  | <a href="#">pfWrite16_A1</a>  | Pointer to a function which writes one word to the controller with C/D line high.        |
| <code>void (*)(U16 * pData, int NumItems);</code> | <a href="#">pfWriteM16_A0</a> | Pointer to a function which writes multiple words to the controller with C/D line low.   |
| <code>void (*)(U16 * pData, int NumItems);</code> | <a href="#">pfWriteM16_A1</a> | Pointer to a function which writes multiple words to the controller with C/D line high.  |
| <code>U16 (*)(void);</code>                       | <a href="#">pfRead16_A0</a>   | Pointer to a function which reads one word from the controller with C/D line low.        |
| <code>U16 (*)(void);</code>                       | <a href="#">pfRead16_A1</a>   | Pointer to a function which reads one word from the controller with C/D line high.       |
| <code>void (*)(U16 * pData, int NumItems);</code> | <a href="#">pfReadM16_A1</a>  | Pointer to a function which reads multiple words from the controller with C/D line high. |



## 11.7.21 GUIDRV\_CompactColor\_16

### 11.7.21.1 Supported Hardware

#### Controllers

This driver works with the following display controllers:

- Ampire FSA506
- Epson S1D13742, S1D13743, S1D19122
- FocalTech FT1509
- Himax HX8301, HX8312A, HX8325A, HX8340, HX8347, HX8352, HX8352B, HX8353
- Hitachi HD66766, HD66772, HD66789
- Ilitek ILI9161, ILI9220, ILI9221, ILI9320, ILI9325, ILI9326, ILI9328, ILI9342, ILI9481
- LG Electronics LGDP4531, LGDP4551
- MagnaChip D54E4PA7551
- Novatek NT39122, NT7573
- OriseTech SPFD5408, SPFD54124C, SPFD5414D, SPFD5420A
- Renesas R61505, R61509, R61516, R61526, R61580, R63401
- Samsung S6D0110A, S6D0117, S6D0128, S6D0129, S6D04H0
- Sharp LCY-A06003, LR38825
- Sitronix ST7628, ST7637, ST7687, ST7712, ST7715, ST7735, ST7787, ST7789
- Solomon SSD1284, SSD1289, SSD1298, SSD1355, SSD1961, SSD1963, SSD2119
- Toshiba JBT6K71

#### Bits per pixel

Supported color depth is 16 bpp.

#### Interfaces

The driver supports the indirect interface (8- and 16-bit) and the 3 pin SPI interface. Default mode is 8-bit indirect.

### 11.7.21.2 Driver selection and configuration

To be able to use this driver the following macro definition needs to be added to the configuration file `LCDCConf.h`:

```
#define LCD_USE_COMPACT_COLOR_16
```

After this define has been added the display driver assumes the driver specific configuration file `LCDCConf_CompactColor_16.h` in the configuration folder. All further compile time configuration macros should be defined in this file. To create a driver device using the `GUI-DRV_CompactColor_16` for the given display, e.g. the following command can be used:

```
pDevice = GUI_DEVICE_CreateAndLink(GUIDRV_COMPACT_COLOR_16, GUICC_565, 0, 0);
```

Detailed information about palette modes can be found in the chapter *Colors* on page 478.

### 11.7.21.3 Display data RAM organization

#### 16 bits per pixel, fixed palette = 565

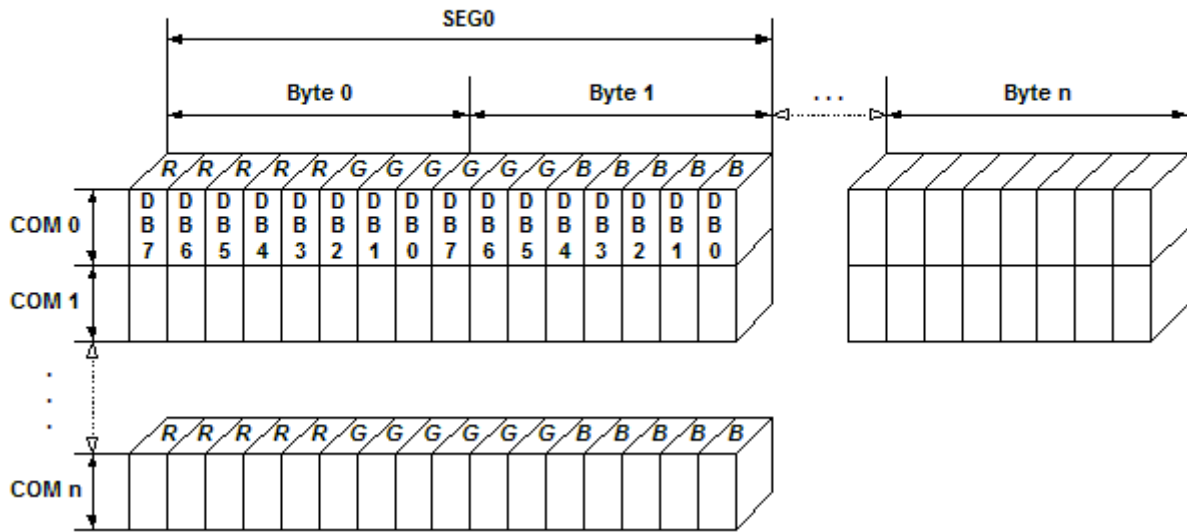

The picture above shows the relation between the display memory and the SEG and COM lines of the display.

### 11.7.21.4 RAM requirements

This display driver can be used with and without a display data cache, containing a complete copy of the contents of the display data RAM. The amount of memory used by the cache is:

```
LCD_XSIZE \times LCD_YSIZE \times 2 bytes
```

Using a cache is only recommended if it is intended to use a lot of drawing operations using the XOR drawing mode. A cache would avoid reading the display data in this case. Normally the use of a cache is not recommended.

The driver uses a write buffer for drawing multiple pixels of the same color. If multiple pixels of the same color should be drawn, the driver first fills the buffer and then performs a single call of the `LCD_WRITEITEM_A1` macro to transfer the data to the display controller at once. The default buffer size is 500 bytes.

### 11.7.21.5 Compile-time configuration

#### Controller selection

To select the desired controller the macro `LCD_CONTROLLER` should be used in the configuration file `LCDConf_CompactColor_16.h`. The following table shows the values to be used to select the appropriate controller:

| Number | Supported controller  |
|--------|---|
| 66700  | Sharp LR38825   |
| 66701  | <ul style="list-style-type: none"> <li>Ilitek ILI9326</li> <li>OriseTech SPFD5420A</li> <li>Renesas R61509, R63401</li> </ul> |
| 66702  | Solomon SSD1284, SSD1289, SSD1298   |
| 66703  | Toshiba JBT6K71   |
| 66704  | Sharp LCY-A06003  |
| 66705  | Samsung S6D0129   |

| Number | Supported controller   |
|--------|--|
| 66706  | MagnaChip D54E4PA7551  |
| 66707  | Himax HX8312   |
| 66708  | <ul style="list-style-type: none"> <li>FocalTech FT1509</li> <li>Ilitek ILI9320, ILI9325, ILI9328</li> <li>LG Electronics LGDP4531, LGDP4551</li> <li>OriseTech SPFD5408</li> <li>Renesas R61505, R61580</li> </ul>  |
| 66709  | <ul style="list-style-type: none"> <li>Epson S1D19122</li> <li>Himax HX8353</li> <li>Ilitek ILI9342, ILI9481</li> <li>Novatek NT39122</li> <li>Orisetech SPFD54124C, SPFD5414D</li> <li>Renesas R61516, R61526</li> <li>Samsung S6D04H0</li> <li>Sitronix ST7628, ST7637, ST7687, ST7715, ST7735</li> <li>Solomon SSD1355, SSD1961, SSD1963</li> </ul> |
| 66710  | Novatek NT7573   |
| 66711  | Epson S1D13742, S1D13743   |
| 66712  | Himax HX8347, HX8352   |
| 66713  | Himax HX8340   |
| 66714  | Solomon SSD2119  |
| 66715  | Himax HX8352B  |
| 66716  | Ampire FSA506  |
| 66717  | Sitronix ST7787, ST7789  |
| 66766  | <ul style="list-style-type: none"> <li>Hitachi HD66766</li> <li>Ilitek ILI9161</li> <li>Samsung S6D0110A</li> </ul>  |
| 66772  | <ul style="list-style-type: none"> <li>Himax HX8301</li> <li>Hitachi HD66772</li> <li>Ilitek ILI9220, ILI9221</li> <li>Samsung S6D0117, S6D0128</li> <li>Sitronix ST7712</li> </ul>  |
| 66789  | Hitachi HD66789  |

## Display configuration

The following table shows the available configuration macros:

| Macro                        | Description                     |
|------------------------------|---------------------------------|
| <a href="#">LCD_MIRROR_X</a> | Activate to mirror X-axis.      |
| <a href="#">LCD_MIRROR_Y</a> | Activate to mirror Y-axis.      |
| <a href="#">LCD_SWAP_XY</a>  | Activate to swap X- and Y-axis. |

For details, refer to *Display orientation* on page 2942.

## Hardware access

The following table shows the available configuration macros which can be defined in this file for configuring the hardware access:

| Macro                               | Description  |
|-------------------------------------|--|
| <a href="#">LCD_NUM_DUMMY_READS</a> | Number of required dummy reads if a read operation should be executed. The default value is 2. If using a serial interface the display controllers |

| Macro                 | Description  |
|-----------------------|--|
|                       | HD66766 and HD66772 need 5 dummy reads. Sharp LR38825 needs 3 dummy reads with a 8-bit bus.  |
| LCD_REG01             | This macro is only required if a Himax HX8312A is used. Unfortunately the register 0x01 (Control register 1) contains orientation specific settings as well as common settings. So this macro should contain the contents of this register.  |
| LCD_SERIAL_ID         | With a serial 3 wire interface this macro defines the ID signal of the device ID code. It should be 0 (default) or 1.<br><b>Please note:</b> This macro is only used with the 3 wire protocol for Hitachi HD66772, Samsung S6D0117, Himax HX8301 and Ilitek ILI9220.   |
| LCD_USE_SERIAL_3PIN   | This configuration macro has been implemented to support the 3 wire serial interface of the following controllers: Hitachi HD66772, Samsung S6D0117, Himax HX8301, Ilitek ILI9220. Should be set to 1 if the 3 wire serial interface is used. Default is 0.<br><b>Please note:</b> Do not use this macro with other display controllers!       |
| LCD_USE_PARALLEL_16   | Should be set to 1 if the 16 bit parallel interface is used. Default is 0.   |
| LCD_WRITE_BUFFER_SIZE | Defines the size of the write buffer. Using a write buffer increases the performance of the driver. If multiple pixels should be written with the same color, the driver first fills the buffer and then writes the content of the buffer using LCD_WRITEM_A1 instead of multiple calls of LCD_WRITE_A1. The default buffer size is 500 bytes. |
| LCD_WRITE_A0          | Write a byte to display controller with RS-line low.   |
| LCD_WRITE_A1          | Write a byte to display controller with RS-line high.  |
| LCD_READM_A1          | Read multiple bytes (8 bit parallel interface) or multiple words (16 bit parallel interface) from display controller with RS-line high.  |
| LCD_WRITEM_A1         | Write multiple bytes (8 bit parallel interface) or multiple words (16 bit parallel interface) to display controller with RS-line high.   |
| LCD_WRITEM_A0         | Write multiple bytes (8 bit parallel interface) or multiple words (16 bit parallel interface) to display controller with RS-line low.  |

The 'Driver Output Mode' and 'Entry Mode' registers are initialized automatically.

### 11.7.21.6 Additional configuration switches

The following table shows optional configuration switches available for this driver:

| Macro                    | Description  |
|--------------------------|--|
| LCD_CACHE                | When set to 0, no display data cache is used, which slows down the speed of the driver. Default is 1 (cache activated).  |
| LCD_FIRSTCOM0            | This macro can be used to define the first common address to be used in the data RAM of the display controller. The value can be determined experimentally or taken from the display doc.  |
| LCD_FIRSTSEG0            | This macro can be used to define the first segment address to be used in the data RAM of the display controller. The value can be determined experimentally or taken from the display doc. |
| LCD_SUPPORT_CACHECONTROL | When set to 1, LCD_ControlCache() can be used.   |

### 11.7.21.7 Configuration example

The following shows how to select the driver and how it can be configured:

#### LCDCConf.h

As explained above it should include the following for selecting the driver:

```
#define LCD_USE_COMPACT_COLOR_16
```

## LCDConf\_CompactColor\_16.h

This file contains the display driver specific configuration and could look as the following:

```
//
// General configuration of LCD
//
#define LCD_CONTROLLER      66709 // Renesas R61516
#define LCD_BITSPERPIXEL   16
#define LCD_USE_PARALLEL_16 1
#define LCD_MIRROR_Y       1
//
// Indirect interface configuration
//
void LCD_X_Write01_16(unsigned short c);
void LCD_X_Write00_16(unsigned short c);
void LCD_X_WriteM01_16(unsigned short * pData, int NumWords);
void LCD_X_WriteM00_16(unsigned short * pData, int NumWords);
void LCD_X_ReadM01_16 (unsigned short * pData, int NumWords);
#define LCD_WRITE_A1(Word) LCD_X_Write01_16(Word)
#define LCD_WRITE_A0(Word) LCD_X_Write00_16(Word)
#define LCD_WRITEM_A1(Word, NumWords) LCD_X_WriteM01_16(Word, NumWords)
#define LCD_WRITEM_A0(Word, NumWords) LCD_X_WriteM00_16(Word, NumWords)
#define LCD_READM_A1(Word, NumWords) LCD_X_ReadM01_16(Word, NumWords)
```

## LCDConf.c

The following shows how to create a display driver device with this driver and how to configure it:

```
void LCD_X_Config(void) {
    //
    // Set display driver and color conversion
    //
    GUI_DEVICE_CreateAndLink(GUIDRV_COMPACT_COLOR_16, // Display driver
                             GUICC_M565,             // Color conversion
                             0, 0);

    //
    // Display driver configuration
    //
    LCD_SetSizeEx(0, 240, 320);
    // Physical display size in pixels
}
}
```

## 11.7.22 GUIDRV\_Fujitsu\_16

This driver supports the Fujitsu Graphic display controllers. It has been tested with "Jasmine", but it should also work with "Lavender", since all relevant registers are compatible.

### 11.7.22.1 Supported hardware

#### Controllers

This driver works with the following display controllers:

- Fujitsu Jasmine
- Fujitsu Lavender

#### Bits per pixel

Supported color depths are 1, 2, 4, 8 and 16 bpp.

#### Interfaces

The driver has been tested with a 32 bit interface to the CPU. If a 16 bit interface is used, the 32-bit accesses can be replaced by 2 16-bit accesses.

### 11.7.22.2 Driver selection and configuration

To be able to use this driver the following macro definition needs to be added to the configuration file `LCDConf.h`:

```
#define LCD_USE_FUJITSU_16
```

After this define has been added the display driver assumes the driver specific configuration file `LCDConf_Fujitsu_16.h` in the configuration folder. All further compile time configuration macros should be defined in this file. To create a driver device using the `GUIDRV_Fujitsu_16` for the given display, e.g. the following command can be used:

```
pDevice = GUI_DEVICE_CreateAndLink(GUIDRV_FUJITSU_16, GUICC_556, 0, 0);
```

Detailed information about palette modes can be found in the chapter *Colors* on page 478.

### 11.7.22.3 Available configuration macros (compile time configuration)

#### Controller selection

To select the desired controller the macro `LCD_CONTROLLER` should be used in the configuration file `LCDConf_Fujitsu_16.h`. The following table shows the values to be used to select the appropriate controller:

| Number | Supported controller |
|--------|----------------------|
| 8720   | Fujitsu Jasmine      |
| 8721   | Fujitsu Lavender     |

### 11.7.22.4 Display data RAM organization

The display controller uses DRAM in an optimized, non-linear way (described in the Fujitsu documentation). Direct memory access is not used by the driver.

### 11.7.22.5 RAM requirements

About 16 bytes for some static variables.

### 11.7.22.6 Hardware configuration

This driver requires a direct interface for hardware access as described in the chapter *Configuration* on page 100. The following table lists the macros which must be defined for hardware access:

| Macro                      | Description  |
|----------------------------|--|
| <code>LCD_READ_REG</code>  | Read a register of the display controller. (as 32 bit value) (optional)  |
| <code>LCD_WRITE_REG</code> | Write a register of the display controller. (as 32 bit value) (optional) |

The driver contains a default for hardware access macros, which configures 32 bit access on the Fujitsu demonstration platform (Using an MB91361 or MB91362 and a Jasmine chip at address `0x30000000`); if the target hardware is compatible with these settings, then `LCD_READ_REG()`, `LCD_WRITE_REG()` do not need to be defined.

#### Color format (R/B swap)

It seems that on some target systems, Red and blue are swapped. This can be changed via software if the config switch `LCD_SWAP_RB` is toggled in the configuration file.

#### Hardware initialization

The display controller requires a complicated initialization. Example code is available from Fujitsu in the GDC module. This code is not part of the driver, since it depends on the actual chip used, on the clock settings, the display and a lot of other things. We recommend using the original Fujitsu code, since the documentation of the chips is not sufficient to write this code. Before calling `GUI_Init()`, the GDC should be initialized using this code (typically called as `GDC_Init(0xff)`).

#### Example

`LCDCnf.h` for VGA display, 8bpp, Jasmine:

```
#define LCD_XSIZE      640 // X-resolution of LCD, Logical color
#define LCD_YSIZE      480 // Y-resolution of LCD, Logical color
#define LCD_BITSPERPIXEL  8
#define LCD_CONTROLLER 8720 // Jasmine
```

### 11.7.22.7 Additional configuration switches

The following table shows optional configuration macros available for this driver:

| Macro                | Description  |
|----------------------|--|
| <code>LCD_ON</code>  | Function replacement macro which switches the display on.  |
| <code>LCD_OFF</code> | Function replacement macro which switches the display off. |

## 11.7.23 GUIDRV\_Page1bpp

### 11.7.23.1 Supported hardware

#### Controllers

This driver works with the following display controllers:

- Epson S1D10605, S1D15605, S1D15705, S1D15710, S1D15714, S1D15721, S1D15E05, S1D15E06, SED1520, SED1560, SED1565, SED1566, SED1567, SED1568, SED1569, SED1575
- Hitachi HD61202
- Integrated Solutions Technology IST3020
- New Japan Radio Company NJU6676, NJU6679
- Novatek NT7502, NT7534, NT7538, NT75451
- Philips PCF8810, PCF8811, PCF8535, PCD8544
- Samsung KS0108B, KS0713, KS0724, S6B0108B, S6B0713, S6B0719, S6B0724, S6B1713
- Sino Wealth SH1101A
- Sitronix ST7522, ST7565, ST7567
- Solomon SSD1303, SSD1805, SSD1815, SSD1821
- ST Microelectronics ST7548, STE2001, STE2002
- Sunplus SPLC501C
- UltraChip UC1601, UC1606, UC1608, UC1701

It should be assumed that it will also work with every similar organized controller.

#### Bits per pixel

Supported color depth is 1bpp.

#### Interfaces

The driver supports the indirect interface (8 bit) of the display controller. Parallel, 4-pin SPI or I2C bus can be used.

### 11.7.23.2 Driver selection and configuration

To be able to use this driver the following macro definition needs to be added to the configuration file `LCDCConf.h`:

```
#define LCD_USE_PAGE1BPP
```

After this define has been added the display driver assumes the driver specific configuration file `LCDCConf_Page1bpp.h` in the configuration folder. All further compile time configuration macros should be defined in this file. To create a driver device using the `GUIDRV_Page1bpp` for the given display, e.g. the following command can be used:

```
pDevice = GUI_DEVICE_CreateAndLink(GUIDRV_PAGE1BPP, GUICC_1, 0, 0);
```

Detailed information about palette modes can be found in the chapter *Colors* on page 478.

### 11.7.23.3 Compile-time configuration

#### Controller selection

To select the desired controller the macro `LCD_CONTROLLER` should be used in the configuration file `LCDCConf_Page1bpp.h`. The following table shows the values to be used to select the appropriate controller:

| Number | Supported controller                       |
|--------|--|
| 1501   | • Samsung KS0713, KS0724, S6B0713, S6B0724 |



| Number | Supported controller   |
|--------|--|
|        | <ul style="list-style-type: none"> <li>UltraChip UC1601, UC1606</li> </ul>   |
| 1502   | Samsung KS0108B S6B0108B   |
| 1503   | Hitachi HD61202  |
| 1504   | Philips PCF8810, PCF8811   |
| 1505   | Philips PCF8535  |
| 1506   | New Japan Radio Company NJU6679  |
| 1507   | Philips PCD8544  |
| 1508   | Epson S1D15710   |
| 1509   | Solomon SSD1303 OLED controller  |
| 1510   | <ul style="list-style-type: none"> <li>Epson S1D15714</li> <li>Integrated Solutions Technology IST3020</li> <li>New Japan Radio Company NJU6676</li> <li>Novatek NT7538, NT75451</li> <li>Samsung S6B0719</li> <li>Sino Wealth SH1101A</li> <li>Sitronix ST7522, ST7565, ST7567</li> <li>Solomon SSD1805, SSD1821</li> <li>UltraChip UC1608, UC1701</li> </ul> |
| 1511   | Epson S1D15721   |
| 1512   | Epson S1D15E05, S1D15E06   |
| 1513   | ST Microelectronics ST7548, STE2001, STE2002   |
| 1520   | Epson SED1520  |
| 1560   | Epson SED1560  |
| 1565   | <ul style="list-style-type: none"> <li>Epson SED1565, S1D10605, S1D15605</li> <li>Novatek NT7502, NT7534</li> <li>Samsung S6B1713</li> <li>Solomon SSD1815</li> <li>Sunplus SPLC501C</li> </ul>  |
| 1566   | Epson SED1566  |
| 1567   | Epson SED1567  |
| 1568   | Epson SED1568  |
| 1569   | Epson SED1569  |
| 1575   | Epson SED1575, S1D15705  |

### 11.7.23.4 RAM requirements

This display driver can be used with or without a display data cache in the most cases. If one display contains more than 1 display controller you can not disable the cache. The data cache contains a complete copy of the contents of the display data RAM. If a cache is not used, there are no additional RAM requirements.

It is recommended to use this driver with a data cache for faster display-access. The amount of memory used by the cache may be calculated as follows:

$$\text{Size of RAM (in bytes)} = (\text{LCD\_YSIZE} + 7) / 8 * \text{LCD\_XSIZE}$$

### 11.7.23.5 Additional driver functions

#### LCD\_ControlCache

The detailed description of this function can be found under *LCD\_ControlCache* on page 3137.

### 11.7.23.6 Hardware configuration

This driver accesses the hardware via indirect interface as described in the chapter *Configuration* on page 100. The following table lists the macros which must be defined for hardware access:

| Macro          | Description  |
|----------------|--|
| LCD_READ_A0    | Read a byte from the display controller with A-line low.         |
| LCD_READ_A1    | Read a byte from the display controller with A-line high.        |
| LCD_WRITE_A0   | Write a byte to the display controller with A-line low.          |
| LCD_WRITE_A1   | Write a byte to the display controller with A-line high.         |
| LCD_WRITE_M_A1 | Write multiple bytes to the display controller with A-line high. |

#### Display orientation

Some of the supported display controllers supports hardware mirroring of x/y axis. It is recommended to use these functions instead of the display orientation macros of emWin. If mirroring of the X axis is needed, the command `0xA1` (ADC select reverse) should be used in the initialization macro. This causes the display controller to reverse the assignment of column address to segment output. If the display size in X is smaller than the number of segment outputs of the display controller, the macro `LCD_FIRSTSEG0` can be used to add an offset to the column address to make sure, the right RAM address of the display controller is accessed.

If mirroring of the Y axis is needed the command `0xC8` (SHL select revers) should be used in the initialization macro and the macro `LCD_FIRSTCOM0` should be used to define the offset needed to access the right RAM address of the display controller.

### 11.7.23.7 Additional configuration switches

The following table shows optional configuration switches available for this driver:

| Macro                                 | Description  |
|---------------------------------------|--|
| <code>LCD_CACHE</code>                | When set to 0, no display data cache is used, which slows down the speed of the driver. Default is 1 (cache activated).  |
| <code>LCD_FIRSTCOM0</code>            | This macro can be used to define the first common address to be used in the data RAM of the display controller. The value can be determined experimentally or taken from the display doc.  |
| <code>LCD_FIRSTSEG0</code>            | This macro can be used to define the first segment address to be used in the data RAM of the display controller. The value can be determined experimentally or taken from the display doc. |
| <code>LCD_SUPPORT_CACHECONTROL</code> | When set to 1, <code>LCD_ControlCache()</code> can be used.  |

## 11.7.24 GUIDRV\_07X1

### 11.7.24.1 Supported hardware

#### Controllers

This driver works with the following display controllers:

- Novatek NT7506, NT7508
- Samsung KS0711, KS0741, S6B0711, S6B0741
- Sitronix ST7541, ST7571
- Solomon SSD1854
- ST Microelectronics STE2010
- Tomato TL0350A

#### Bits per pixel

Supported color depth is 2 bpp.

#### Interface

The controller supports either the 8-bit parallel interface as well as the 4-pin or 3-pin serial peripheral interface (SPI). The current version of the driver supports the 8-bit parallel or 4-pin SPI interface. 3 pin SPI is currently not supported.

### 11.7.24.2 Driver selection and configuration

To be able to use this driver the following macro definition needs to be added to the configuration file `LCDConf.h`:

```
#define LCD_USE_07X1
```

After this define has been added the display driver assumes the driver specific configuration file `LCDConf_07X1.h` in the configuration folder. All further compile time configuration macros should be defined in this file. To create a driver device using the `GUIDRV_07X1` for the given display, e.g. the following command can be used:

```
pDevice = GUI_DEVICE_CreateAndLink(GUIDRV_07X1, GUICC_2, 0, 0);
```

Detailed information about palette modes can be found in the chapter *Colors* on page 478.

#### Controller selection

To select the desired controller the macro `LCD_CONTROLLER` should be used in the configuration file `LCDConf_07X1.h`. The following table shows the values to be used to select the appropriate controller:

| Number | Supported controller   |
|--------|--|
| 701    | <ul style="list-style-type: none"> <li>• Novatek NT7506</li> <li>• Solomon SSD1854</li> </ul>  |
| 702    | ST Microelectronics STE2010  |
| 711    | Samsung KS0711, S6B0711  |
| 741    | <ul style="list-style-type: none"> <li>• Novatek NT7508</li> <li>• Samsung KS0741, S6B0741</li> <li>• Sitronix ST7541, ST7571</li> <li>• Tomato TL0350A</li> </ul> |

### 11.7.24.3 Display data RAM organization

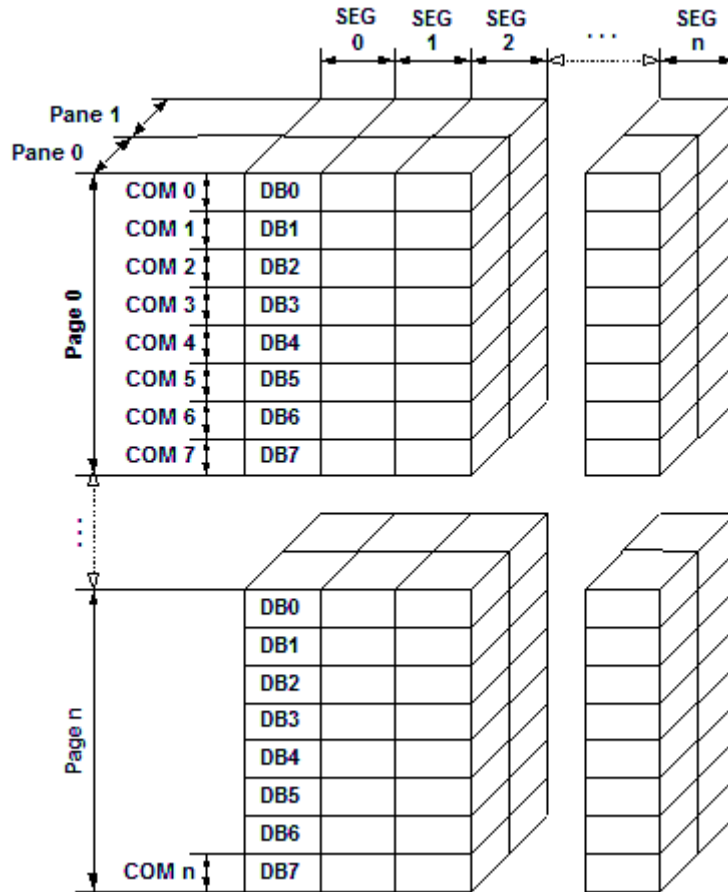

The picture above shows the relation between the display memory and the SEG and COM lines of the display. The display memory is divided into two panes for each pixel. The lower bit of each pixel is stored in pane 0 and the higher bit is stored in pane 1.

### 11.7.24.4 RAM requirements

This display driver may be used with or without a display data cache, containing a complete copy of the contents of the display data RAM. If a cache is not used, there are no additional RAM requirements.

It is recommended to use this driver with a data cache for faster display-access. The amount of memory used by the cache may be calculated as follows:

$$\text{Size of RAM (in bytes)} = (\text{LCD\_YSIZE} + 7) / 8 * \text{LCD\_XSIZE} * 2$$

### 11.7.24.5 Additional driver functions

#### LCD\_ControlCache

The detailed function description can be found {LCD\_ControlCache}.

### 11.7.24.6 Hardware configuration

This driver accesses the hardware using the indirect interface as described in the chapter *Configuration* on page 100. The following table lists the macros which must be defined for hardware access:

| Macro       | Description   |
|-------------|---|
| LCD_READ_A0 | Read a byte from display controller with A-line low. (Used only if working without cache) |

| Macro                         | Description  |
|-------------------------------|--|
| <a href="#">LCD_READ_A1</a>   | Read a byte from display controller with A-line high. (Used only if working without cache) |
| <a href="#">LCD_WRITE_A0</a>  | Write a byte to display controller with A-line low.  |
| <a href="#">LCD_WRITE_A1</a>  | Write a byte to display controller with A-line high.                                       |
| <a href="#">LCD_WRITEM_A1</a> | Write multiple bytes to display controller with A-line high.                               |

## Display orientation

The supported display controllers supports hardware mirroring of x/y axis. It is recommended to use these functions instead of the display orientation macros of emWin. If mirroring of the X axis is needed, the command `0xA1` (ADC select reverse) should be used in the initialization macro. This causes the display controller to reverse the assignment of column address to segment output. If the display size in X is smaller than the number of segment outputs of the display controller, the macro `LCD_FIRSTSEG0` can be used to add an offset to the column address to make sure, the right RAM address of the LCD controller is accessed. If mirroring of the Y axis is needed the command `0xC8` (SHL select revers) should be used in the initialization macro and the macro `LCD_FIRSTCOM0` should be used to define the offset needed to access the right RAM address of the display controller.

### 11.7.24.7 Additional configuration switches

The following table shows optional configuration switches available for this driver:

| Macro                         | Description  |
|-------------------------------|--|
| <a href="#">LCD_FIRSTCOM0</a> | This macro can be used to define the first common address to be used in the data RAM of the display controller. The value can be determined experimentally or taken from the display documentation.  |
| <a href="#">LCD_FIRSTSEG0</a> | This macro can be used to define the first segment address to be used in the data RAM of the display controller. The value can be determined experimentally or taken from the display documentation. |

## 11.7.25 GUIDRV\_6331

### 11.7.25.1 Supported hardware

#### Controllers

This driver works with the following display controllers:

- Samsung S6B33B0X, S6B33B1X, S6B33B2X

#### Bits per pixel

Supported color depth is 16 bpp.

#### Interfaces

The driver supports the indirect interface (8 bit) of the display controller. Parallel or 4-pin SPI bus can be used.

### 11.7.25.2 Driver selection and configuration

To be able to use this driver the following macro definition needs to be added to the configuration file `LCDCConf.h`:

```
#define LCD_USE_6331
```

After this define has been added the display driver assumes the driver specific configuration file `LCDCConf_6331.h` in the configuration folder. All further compile time configuration macros should be defined in this file. To create a driver device using the `GUIDRV_6331` for the given display, e.g. the following command can be used:

```
pDevice = GUI_DEVICE_CreateAndLink(GUIDRV_6331, GUICC_565, 0, 0);
```

Detailed information about palette modes can be found in the chapter *Colors* on page 478.

#### Controller selection

To select the desired controller the macro `LCD_CONTROLLER` should be used in the configuration file `LCDCConf_6331.h`. The table below shows the values to be used to select the appropriate controller:

| Number | Supported controller                 |
|--------|--------------------------------------|
| 6331   | Samsung S6B33B0X, S6B33B1X, S6B33B2X |

### 11.7.25.3 Display data RAM organization

#### 16 bits per pixel, fixed palette = 565

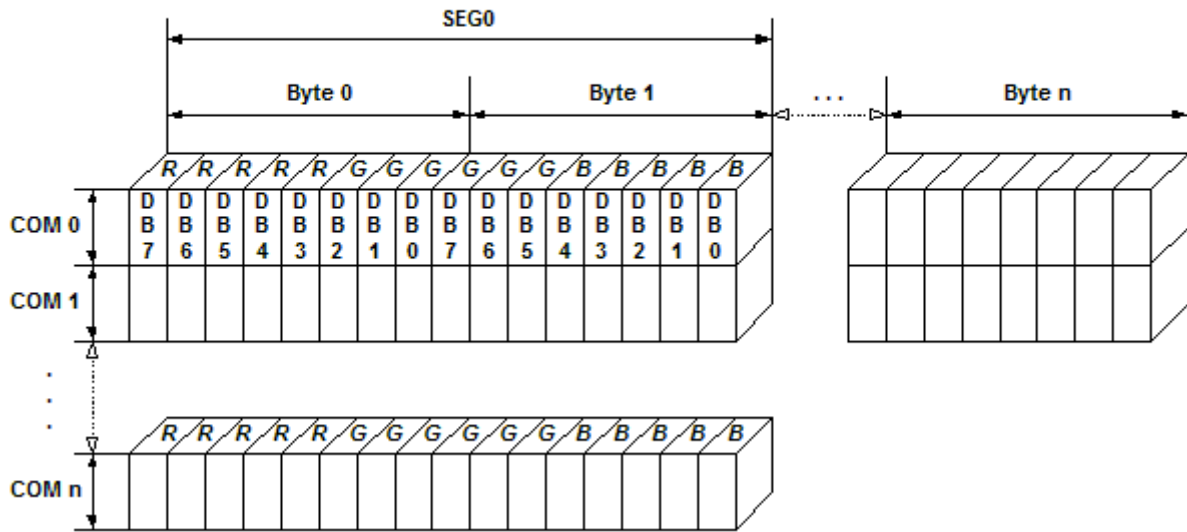

The picture above shows the relation between the display memory and the SEG and COM lines of the LCD.

### 11.7.25.4 RAM requirements

This display driver can be used with or without a display data cache, containing a complete copy of the LCD data RAM. The amount of memory used by the cache is:

```
LCD_XSIZE * LCD_YSIZE * 2 bytes.
```

### 11.7.25.5 Hardware configuration

This driver accesses the hardware with the indirect interface. The following table lists the macros which must be defined for hardware access:

| Macro                                      | Description   |
|--|---|
| <a href="#">LCD_WRITE_A0</a>               | Write a byte to display controller with A-line low.   |
| <a href="#">LCD_WRITE_A1</a>               | Write a byte to display controller with A-line high.  |
| <a href="#">LCD_WRITEM_A1</a>              | Write multiple bytes to display controller with A-line high.  |
| <a href="#">LCD_DRIVER_OUTPUT_MODE_DLN</a> | 'Display Line Number' (DLN) selection bits of the 'Driver Output Mode Set' instruction. Details can be found in the display controller documentation. |
| <a href="#">LCD_DRIVER_ENTRY_MODE_16B</a>  | Data bus width selection bit of the 'Entry Mode Set' instruction. Details can be found in the display controller documentation.                       |

The 'Driver Output Mode' and 'Entry Mode' are initializes automatically.

### 11.7.25.6 Additional configuration switches

The following table shows optional configuration switches available for this driver:

| Macro                  | Description   |
|------------------------|---|
| <code>LCD_CACHE</code> | When set to 0, no display data cache is used, which slows down the speed of the driver. Default is 1 (cache activated). |

### 11.7.25.7 Special requirements

The driver needs to work with the fixed palette mode 565. The driver does not work with other palettes or fixed palette modes. Further the driver needs to swap the red and the blue part of the color index. You should use the following macro definitions in the configuration file `LCDCConf.h`:

```
#define LCD_FIXEDPALETTE 565
#define LCD_SWAP_RB 1
```



## 11.7.26 GUIDRV\_7528

### 11.7.26.1 Supported hardware

#### Controllers

This driver works with the Sitronix ST7528 display controller.

#### Bits per pixel

Supported color depth is 4 bpp.

#### Interfaces

The driver supports the 8 bit parallel (simple bus) 4-pin SPI interface.

### 11.7.26.2 Driver selection and configuration

To be able to use this driver the following macro definition needs to be added to the configuration file `LCDConf.h`:

```
#define LCD_USE_7528
```

After this define has been added the display driver assumes the driver specific configuration file `LCDConf_7528.h` in the configuration folder. All further compile time configuration macros should be defined in this file. To create a driver device using the `GUIDRV_7528` for the given display, e.g. the following command can be used:

```
pDevice = GUI_DEVICE_CreateAndLink(GUIDRV_7528, GUICC_4, 0, 0);
```

Detailed information about palette modes can be found in the chapter *Colors* on page 478.

#### Controller selection

To select the desired controller the macro `LCD_CONTROLLER` should be used in the configuration file `LCDConf_7528.h`. The following table shows the values to be used to select the appropriate controller:

| Number | Supported controller |
|--------|----------------------|
| 7528   | Sitronix ST7528      |

### 11.7.26.3 Display data RAM organization

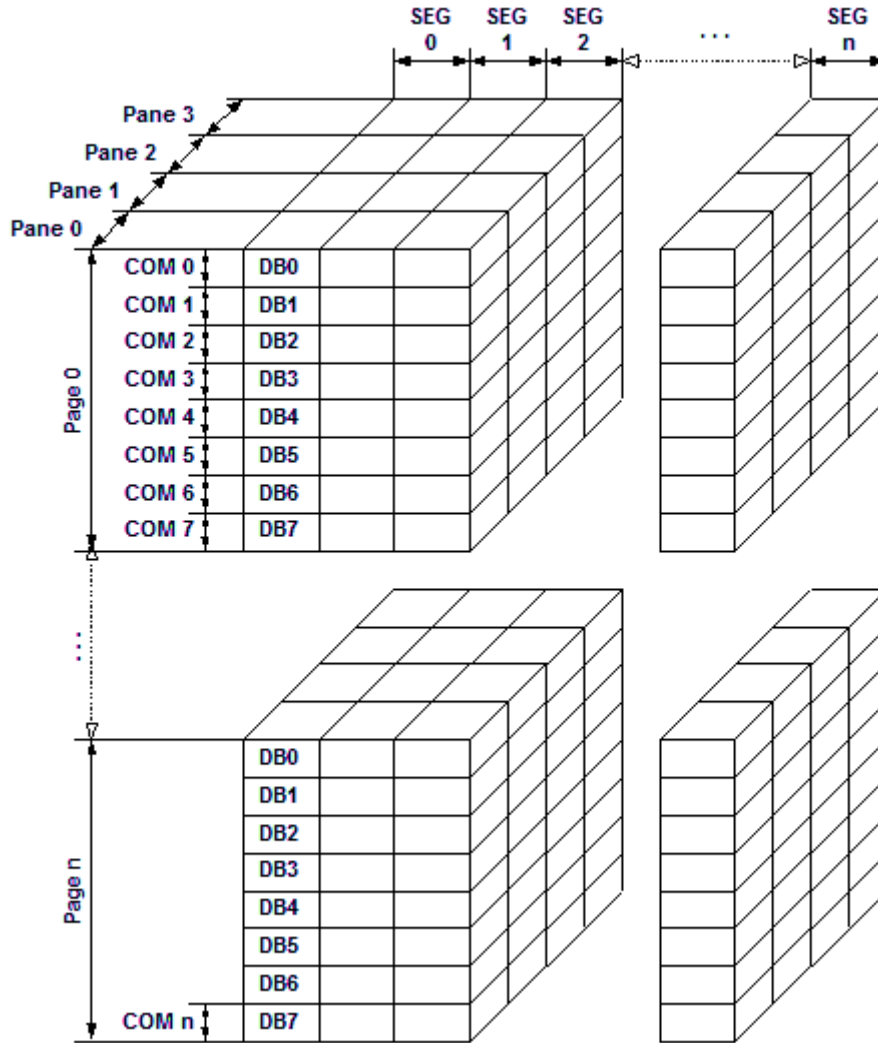

The picture above shows the relation between the display memory and the SEG and COM lines of the LCD. The display memory is divided into four panes for each pixel. The least significant bit (LSB) of each pixel is stored in pane 0 and the MSB is stored in pane 3.

### 11.7.26.4 RAM requirements

This LCD driver may be used with or without a display data cache. If the cache is used it holds a complete copy of the contents of the LCD data RAM. If cache is not used, there are no additional RAM requirements.

It is recommended to use this driver with a data cache for faster LCD-access. The amount of memory used by the cache may be calculated as follows:

$$\text{Size of RAM (in bytes)} = (\text{LCD\_YSIZE} + 7) / 8 * \text{LCD\_XSIZE} * 4$$

A cache is required in SPI mode, because SPI does not allow reading of display contents.

### 11.7.26.5 Hardware configuration

This driver accesses the hardware with the indirect interface. The following table lists the macros which must be defined for hardware access:

| Macro        | Description                                      |
|--------------|--|
| LCD_WRITE_A0 | Write a byte to LCD controller with A-line low.  |
| LCD_WRITE_A1 | Write a byte to LCD controller with A-line high. |

| Macro                        | Description   |
|------------------------------|---|
| <a href="#">LCD_WRITE_A1</a> | Write multiple bytes to display controller with A-line high.  |
| <a href="#">LCD_READ_A1</a>  | Read a single byte from display controller with A-line high. Required only if no display data cache is configured.  |
| <a href="#">LCD_READM_A1</a> | Read multiple bytes from display controller with A-line high. Required only if no display data cache is configured. |

### 11.7.26.6 Additional configuration switches

The following table shows optional configuration switches available for this driver:

| Macro                         | Description  |
|-------------------------------|--|
| <a href="#">LCD_FIRSTCOM0</a> | This macro can be used to define the first common address to be used in the data RAM of the display controller. The value can be determined experimentally or taken from the display documentation.  |
| <a href="#">LCD_FIRSTSEG0</a> | This macro can be used to define the first segment address to be used in the data RAM of the display controller. The value can be determined experimentally or taken from the display documentation.   |
| <a href="#">LCD_NUM_COM0</a>  | A Sitronix ST7528 controller can operate in 2 modes. Mode 0 with 132 segment and 128 common outputs and mode 1 with 160 segment and 100 common outputs. which mode is used depends on hardware, the mode can not be changed via command. Defines the number of available common outputs of the display controller.<br>Possible values for Sitronix ST7528 are: <ul style="list-style-type: none"> <li>• 128 (default, mode 0)</li> <li>• 100 (mode 1)</li> </ul> |
| <a href="#">LCD_NUM_SEG0</a>  | Defines the number of available segment outputs of the display controller.<br>Possible values for Sitronix ST7528 are: <ul style="list-style-type: none"> <li>• 132 (default, mode 0)</li> <li>• 160 (mode 1)</li> </ul>   |
| <a href="#">LCD_CACHE</a>     | When set to 0, no display data cache is used, which slows down the speed of the driver. Default is 1 (cache activated).  |

## 11.7.27 GUIDRV\_7529

### 11.7.27.1 Supported hardware

#### Controllers

This driver works with the Sitronix ST7529 display controller.

#### Bits per pixel

Supported color depths are 5 bpp (default), 4 bpp and 1bpp.

#### Interfaces

The driver supports the indirect interface (8 and 16 bit) of the display controller. Parallel, 3-pin SPI or 4-pin SPI access can be used.

### 11.7.27.2 Driver selection and configuration

To be able to use this driver the following macro definition needs to be added to the configuration file `LCDConf.h`:

```
#define LCD_USE_7529
```

After this define has been added the display driver assumes the driver specific configuration file `LCDConf_7529.h` in the configuration folder. All further compile time configuration macros should be defined in this file. To create a driver device using the `GUIDRV_7529` for the given display, e.g. the following command can be used:

```
pDevice = GUI_DEVICE_CreateAndLink(GUIDRV_7529, GUICC_5, 0, 0);
```

Detailed information about palette modes can be found in the chapter *Colors* on page 478.

#### Controller selection

To select the desired controller the macro `LCD_CONTROLLER` should be used in the configuration file `LCDConf_7529.h`. The following table shows the values to be used to select the appropriate controller:

| Number | Supported controller |
|--------|----------------------|
| 7529   | Sitronix ST7529      |

### 11.7.27.3 Display data RAM organization

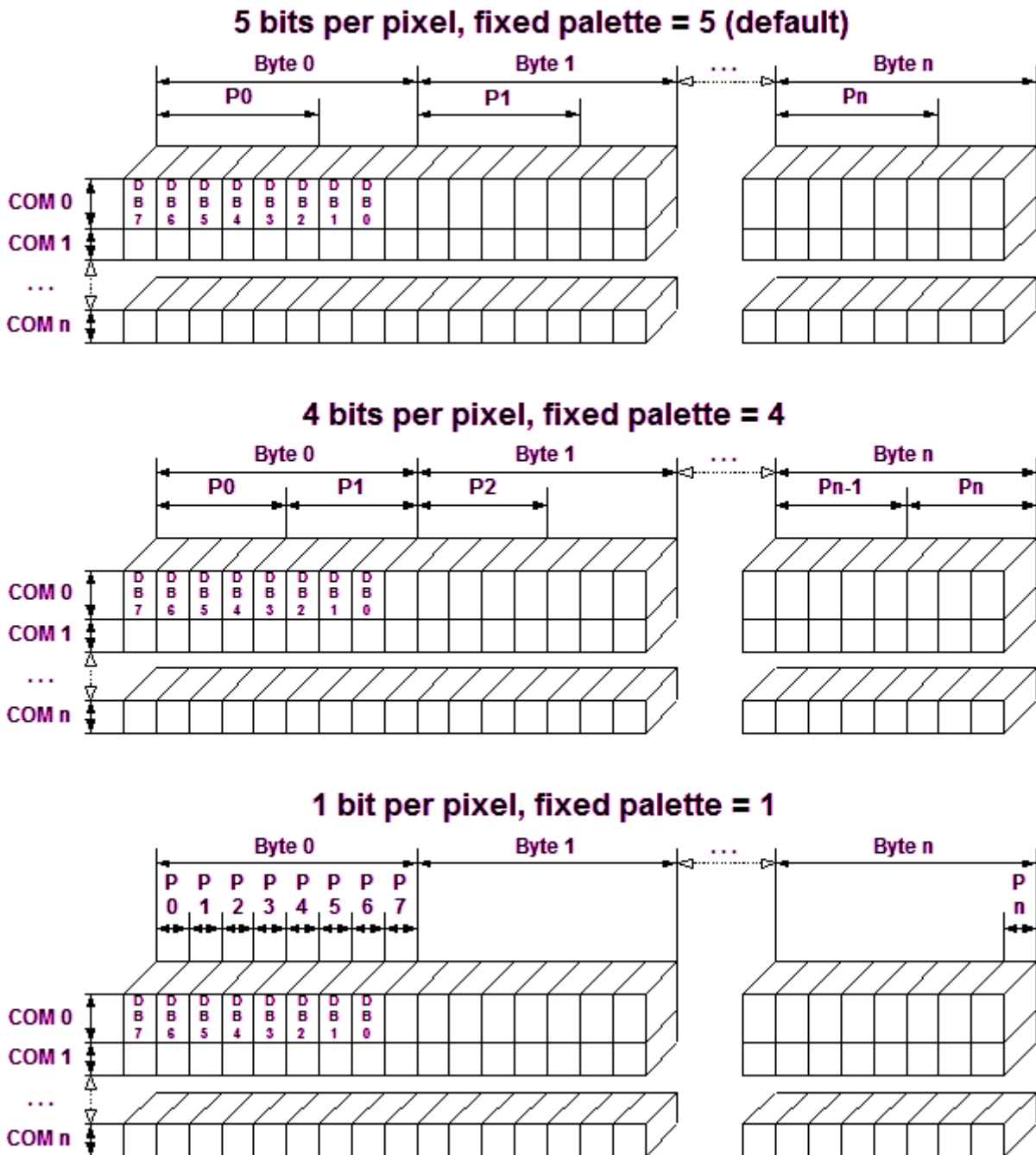

The picture above shows the relation between the display memory and the SEG and COM lines of the LCD.

### 11.7.27.4 RAM requirements

This display driver can be used with or without a display data cache, containing a complete copy of the LCD data RAM. If no cache is used, there are no additional RAM requirements. It is optional (but recommended) to use this driver with a data cache for faster LCD-access. The amount of memory used by the cache may be calculated as follows:

```

5bpp mode:
Size of RAM (in bytes) = (LCD_XSIZE + 2) / 3 * 3 * LCD_YSIZE
4bpp mode:
Size of RAM (in bytes) = ((LCD_XSIZE + 2) / 3 * 3 + 1) / 2 * LCD_YSIZE
1bpp mode:
Size of RAM (in bytes) = ((LCD_XSIZE + 2) / 3 * 3 + 7) / 8 * LCD_YSIZE
    
```

### 11.7.27.5 Hardware configuration

This driver accesses the hardware with the indirect interface. The following table lists the macros which must be defined for hardware access:

| Macro                        | Description  |
|------------------------------|--|
| <code>LCD_WRITE_A0</code>    | Write a byte to LCD controller with A-line low.  |
| <code>LCD_WRITE_A1</code>    | Write a byte to LCD controller with A-line high.   |
| <code>LCD_WRITEM_A1</code>   | Write multiple bytes to display controller with A-line high.   |
| <code>LCD_READM_A1</code>    | Read multiple bytes from display controller with A-line high. Required only if no display data cache is configured.  |
| <code>LCD_FIRSTPIXELO</code> | If the display size in X is smaller than the number of segment outputs of the display controller, this macro can be used for defining the first visible pixel of the display. It should be used if the first segment lines of the display controller are not connected to the display. |

### 11.7.27.6 Additional configuration switches

The following table shows optional configuration switches available for this driver:

| Macro                  | Description   |
|------------------------|---|
| <code>LCD_CACHE</code> | When set to 0, no display data cache is used, which slows down the speed of the driver. Default is 1 (cache activated). |

## 11.7.28 GUIDRV\_Template - Template for a new driver

This driver is part of the basic package and can be easily adapted to each display controller. It contains the complete functionality needed for a display driver.

### Adapting the template driver

To adapt the driver to a currently not supported display controller you only have to adapt the routines `_SetPixelIndex()` and `_GetPixelIndex()`. The upper layers calling this routines already make sure that the given coordinates are in range, so that no check on the parameters needs to be performed.

If a display is not readable the function `_GetPixelIndex()` won't be able to read back the contents of the display data RAM. In this case a display data cache should be implemented in the driver, so that the contents of each pixel is known by the driver. If no data cache is available in this case some functions of emWin will not work right. These are all functions which need to invert pixels. Especially the XOR draw mode and the drawing of text cursors (which also uses the XOR draw mode) will not work right. A simple application which does not use the XOR draw mode will also work without adapting the function `_GetPixelIndex()`.

In a second step it should be optimized to improve drawing speed.

## 11.8 LCD layer and display driver API

This chapter explains functions used to set and get certain layer attributes, for example size, visibility or alpha value of a layer, where each layer is represented by a display driver configured in `LCD_X_Config()`. The chapter also describes how to manage the content of a display driver cache.

Please note that most of the following functions are not thread-safe. Therefore it is recommended to use `GUI_LOCK/GUI_UNLOCK` before/after using them in multitask environments.

### 11.8.1 Display driver API

The table below lists the available routines in alphabetical order. Detailed descriptions follow.

| Routine                              | Description   |
|--------------------------------------|---|
| "Get" group                          |   |
| <code>LCD_GetBitsPerPixel()</code>   | Returns the number of bits per pixel.   |
| <code>LCD_GetBitsPerPixelEx()</code> | Returns the number of bits per pixel of given layer/display.  |
| <code>LCD_GetNumColors()</code>      | Return the number of available colors.  |
| <code>LCD_GetNumColorsEx()</code>    | Returns the number of available colors of given layer/display.  |
| <code>LCD_GetPosEx()</code>          | Returns the position of the given layer in x and y direction.   |
| <code>LCD_GetVRAMAddr()</code>       | Returns the address of the framebuffer for the current layer, more precisely the address of the current Write-Buffer. |
| <code>LCD_GetVRAMAddrEx()</code>     | Returns the address of the framebuffer for the given layer, more precisely the address of the current Write-Buffer.   |
| <code>LCD_GetVXSize()</code>         | Return virtual X-size of LCD in pixels.   |
| <code>LCD_GetVXSizeEx()</code>       | Returns virtual X-size of given layer/display in pixels.  |
| <code>LCD_GetVYSize()</code>         | Return virtual Y-size of LCD in pixels.   |
| <code>LCD_GetVYSizeEx()</code>       | Returns virtual Y-size of given layer/display in pixels.  |
| <code>LCD_GetXMag()</code>           | Returns the magnification factor in x.  |
| <code>LCD_GetXMagEx()</code>         | Returns the magnification factor of given layer/display in x.   |
| <code>LCD_GetXSize()</code>          | Return physical X-size of LCD in pixels.  |
| <code>LCD_GetXSizeEx()</code>        | Returns physical X-size of given layer/display in pixels.   |
| <code>LCD_GetYMag()</code>           | Returns the magnification factor in y.  |
| <code>LCD_GetYMagEx()</code>         | Returns the magnification factor of given layer/display in y.   |
| <code>LCD_GetYSize()</code>          | Return physical Y-size of LCD in pixels.  |
| <code>LCD_GetYSizeEx()</code>        | Returns physical Y-size of given layer/display in pixels.   |
| "Set" group                          |   |
| <code>LCD_SetAlphaEx()</code>        | Sets the layer alpha value.*1   |
| <code>LCD_SetAlphaModeEx()</code>    | Enables layer alpha mode.*1   |
| <code>LCD_SetChromaEx()</code>       | Sets colors to be used for chroma mode.*1   |
| <code>LCD_SetChromaModeEx()</code>   | Enables chroma mode.*1  |



| Routine                            | Description   |
|------------------------------------|---|
| <code>LCD_SetPosEx()</code>        | Sets the layer position of the given layer in x and y direction.                                |
| <code>LCD_SetVisEx()</code>        | Sets the visibility of a layer.*1   |
| Configuration group                |   |
| <code>LCD_SetBufferPtr()</code>    | This function is used to set an array with buffer addresses for the currently selected layer.   |
| <code>LCD_SetBufferPtrEx()</code>  | This function is used to set an array with buffer addresses for the layer with the given index. |
| <code>LCD_Off()</code>             | Switches the display off.*1   |
| <code>LCD_OffEx()</code>           | Switches the given display off.*1   |
| <code>LCD_On()</code>              | Switches the display on.*1  |
| <code>LCD_OnEx()</code>            | Switches the given display on.*1  |
| <code>LCD_Refresh()</code>         | Refreshes the currently selected layer.*1   |
| <code>LCD_RefreshEx()</code>       | Refreshes the layer with the given index.*1   |
| <code>LCD_SetDevFunc()</code>      | Sets optional or custom defined routines for the display driver.*1                              |
| <code>LCD_SetMaxNumColors()</code> | Sets the maximum number of colors used in palette based bitmaps.                                |
| <code>LCD_SetSizeEx()</code>       | Sets the physical size of the visible area of the given display/layer.                          |
| <code>LCD_SetVRAMAddrEx()</code>   | Sets the address of the video RAM of the given layer.*1   |
| <code>LCD_SetVSizeEx()</code>      | Sets the size of the virtual display area of the given layer.*1                                 |
| Cache group                        |   |
| <code>LCD_ControlCache()</code>    | Locks, unlocks and flushes the cache of the display controller if it is supported.              |

### Note

- Optional function, not supported by each driver.

## 11.8.1.1 "Get" group

### 11.8.1.1.1 LCD\_GetBitsPerPixel()

#### Description

Returns the number of bits per pixel.

#### Prototype

```
int LCD_GetBitsPerPixel(void);
```

#### Return value

Number of bits per pixel.

### 11.8.1.1.2 LCD\_GetBitsPerPixelEx()

#### Description

Returns the number of bits per pixel.

#### Prototype

```
int LCD_GetBitsPerPixelEx(int LayerIndex);
```

#### Parameters

| Parameter             | Description  |
|-----------------------|--------------|
| <a href="#">Index</a> | Layer index. |

#### Return value

Number of bits per pixel.

### 11.8.1.1.3 LCD\_GetNumColors()

#### Description

Returns the number of currently available colors on the LCD.

#### Prototype

```
U32 LCD_GetNumColors(void);
```

#### Return value

Number of available colors.

#### 11.8.1.1.4 LCD\_GetNumColorsEx()

##### Description

Returns the number of currently available colors on the LCD.

##### Prototype

```
U32 LCD_GetNumColorsEx(int LayerIndex);
```

##### Parameters

| Parameter             | Description  |
|-----------------------|--------------|
| <a href="#">Index</a> | Layer index. |

##### Return value

Number of available colors.

### 11.8.1.1.5 LCD\_GetPosEx()

#### Description

Returns the position of the given layer in x and y direction.

#### Prototype

```
int LCD_GetPosEx(int LayerIndex,  
                int * pxPos,  
                int * pyPos);
```

#### Parameters

| Parameter                  | Description                             |
|----------------------------|---|
| <a href="#">LayerIndex</a> | Layer index.                            |
| <a href="#">pxPos</a>      | Contains layer position in x direction. |
| <a href="#">pyPos</a>      | Contains layer position in y direction. |

#### Return value

0        on success  
1        on error.

#### Additional information

The content of the passed pointer is getting filled with values for x and y direction of the given layer.

### 11.8.1.1.6 LCD\_GetVRAMAddr()

#### Description

Returns the address of the framebuffer for the current layer, more precisely the address of the current WriteBuffer.

#### Prototype

```
void *LCD_GetVRAMAddr(void);
```

#### Return value

Void pointer to the framebuffer.

### 11.8.1.1.7 LCD\_GetVRAMAddrEx()

#### Description

Returns the address of the framebuffer for the given layer, more precisely the address of the current WriteBuffer.

#### Prototype

```
void *LCD_GetVRAMAddrEx(int LayerIndex);
```

#### Parameters

| Parameter          | Description  |
|--------------------|--------------|
| <code>Index</code> | Layer index. |

#### Return value

Void pointer to the framebuffer of the given layer.



### 11.8.1.1.8 LCD\_GetVXSize()

### 11.8.1.1.9 LCD\_GetVYSize()

#### Description

Returns the virtual X- or Y-size, respectively, of the LCD in pixels. In most cases, the virtual size is equal to the physical size.

#### Prototypes

```
int LCD_GetVXSize(void);
```

```
int LCD_GetVYSize(void);
```

#### Return value

Virtual X/Y-size of the display.

### 11.8.1.1.10 LCD\_GetVXSizeEx()

### 11.8.1.1.11 LCD\_GetVYSizeEx()

#### Description

Returns the virtual X- or Y-size, respectively, of the LCD in pixels. In most cases, the virtual size is equal to the physical size.

#### Prototypes

```
int LCD_GetVXSizeEx(int Index);
```

```
int LCD_GetVYSizeEx(int Index);
```

#### Parameters

| Parameter             | Description  |
|-----------------------|--------------|
| <a href="#">Index</a> | Layer index. |

#### Return value

Virtual X/Y-size of the display.

#### 11.8.1.1.12 LCD\_GetXMag()

#### 11.8.1.1.13 LCD\_GetYMag()

##### Description

Returns the magnification factor in X- or Y-axis, respectively.

##### Prototypes

```
int LCD_GetXMag(void);
```

```
int LCD_GetYMag(void);
```

##### Return value

Magnification factor in X- or Y-axis.

#### 11.8.1.1.14 LCD\_GetXMagEx()

#### 11.8.1.1.15 LCD\_GetYMagEx()

##### Description

Returns the magnification factor in X- or Y-axis, respectively.

##### Prototypes

```
int LCD_GetXMagEx(int Index);
```

```
int LCD_GetYMagEx(int Index);
```

##### Parameters

| Parameter             | Description  |
|-----------------------|--------------|
| <a href="#">Index</a> | Layer index. |

##### Return value

Magnification factor in X- or Y-axis.

#### 11.8.1.1.16 LCD\_GetXSize()

#### 11.8.1.1.17 LCD\_GetYSize()

##### Description

Returns the physical X- or Y-size, respectively, of the LCD in pixels.

##### Prototypes

```
int LCD_GetXSize(void);
```

```
int LCD_GetYSize(void);
```

##### Return value

Physical X/Y-size of the display.

### 11.8.1.1.18 LCD\_GetXSizeEx()

### 11.8.1.1.19 LCD\_GetYSizeEx()

#### Description

Returns the physical X- or Y-size, respectively, of the LCD in pixels.

#### Prototypes

```
int LCD_GetXSizeEx(int Index);
```

```
int LCD_GetYSizeEx(int Index);
```

#### Parameters

| Parameter             | Description  |
|-----------------------|--------------|
| <a href="#">Index</a> | Layer index. |

#### Return value

Physical X/Y-size of the display.

## 11.8.1.2 "Set" group

### 11.8.1.2.1 LCD\_SetAlphaEx()

#### Description

Sets the layer alpha value of the given layer.

#### Prototype

```
int LCD_SetAlphaEx(int LayerIndex,  
                  int Alpha);
```

#### Parameters

| Parameter                  | Description  |
|----------------------------|--|
| <a href="#">LayerIndex</a> | Layer index.   |
| <a href="#">Alpha</a>      | <a href="#">Alpha</a> value (0-255) to be used. 0 means opaque, 255 fully transparent. |

#### Return value

0        on success  
1        on error.

#### Additional information

This feature could only be available if the hardware supports layer alpha blending and if the driver callback function reacts on `LCD_X_SETALPHA`. Please note that the actual reaction on the given parameter(s) takes place in the driver callback function and depends on the customers implementation. The callback function is responsible for managing the appropriate SFRs to do the operation.

### 11.8.1.2.2 LCD\_SetAlphaModeEx()

#### Description

Enables the layer alpha mode of the given layer.

#### Prototype

```
int LCD_SetAlphaModeEx(int LayerIndex,  
                      int AlphaMode);
```

#### Parameters

| Parameter  | Description   |
|------------|---|
| LayerIndex | Layer index.  |
| AlphaMode  | A list of available modes can be found under <i>Transparency modes</i> on page 199. |

#### Return value

0        on success  
1        on error.

#### Additional information

This feature could only be available if the hardware supports layer alpha blending and if the driver callback function reacts on `LCD_X_SETALPHAMODE`. Please note that the actual reaction on the given parameter(s) takes place in the driver callback function and depends on the customers implementation. The callback function is responsible for managing the appropriate SFRs to do the operation. Default behavior of a layer should be pixel alpha mode.



### 11.8.1.2.3 LCD\_SetChromaEx()

#### Description

Sets the colors to be used for the chroma mode.

#### Prototype

```
int LCD_SetChromaEx(int LayerIndex,
                   LCD_COLOR ChromaMin,
                   LCD_COLOR ChromaMax);
```

#### Parameters

| Parameter                  | Description            |
|----------------------------|------------------------|
| <a href="#">LayerIndex</a> | Layer index.           |
| <a href="#">ChromaMin</a>  | See description below. |
| <a href="#">ChromaMax</a>  | See description below. |

#### Return value

0 on success  
1 on error.

#### Additional information

This feature could only be available if the hardware supports chroma blending and if the driver callback function reacts on `LCD_X_SETCHROMA`. The hardware implementations of chroma modes are very different. Because of that the function of the parameters [ChromaMin](#) and [ChromaMax](#) also could have different meanings. In many cases chroma blending only supports one specific transparent color. In that case only the first parameter [ChromaMin](#) should be used. Other systems support a range of color bits to be used or a color and a mask. Please note that the actual reaction on the given parameter(s) takes place in the driver callback function and depends on the customers implementation. The callback function is responsible for managing the appropriate SFRs to do the operation.

### 11.8.1.2.4 LCD\_SetChromaModeEx()

#### Description

Enables the chroma mode of the given layer.

#### Prototype

```
int LCD_SetChromaModeEx(int LayerIndex,  
                        int ChromaMode);
```

#### Parameters

| Parameter  | Description   |
|------------|---|
| LayerIndex | Layer index.  |
| ChromaMode | 1 for enabling chroma mode, 0 for disabling (default) |

#### Return value

0        on success  
1        on error.

#### Additional information

This feature could only be available if the hardware supports chroma blending and if the driver callback function reacts on `LCD_X_SETCHROMAMODE`. Please note that the actual reaction on the given parameter(s) takes place in the driver callback function and depends on the customers implementation. The callback function is responsible for managing the appropriate SFRs to do the operation.

### 11.8.1.2.5 LCD\_SetPosEx()

#### Description

Sets the layer position of the given layer in x and y direction.

#### Prototype

```
int LCD_SetPosEx(int LayerIndex,  
                int xPos,  
                int yPos);
```

#### Parameters

| Parameter  | Description                  |
|------------|------------------------------|
| LayerIndex | Layer index.                 |
| xPos       | New position in x direction. |
| yPos       | New position in y direction. |

#### Return value

0        on success  
1        on error.

### 11.8.1.2.6 LCD\_SetVisEx()

#### Description

Sets the visibility of the given layer.

#### Prototype

```
int LCD_SetVisEx(int LayerIndex,  
                int OnOff);
```

#### Parameters

| Parameter  | Description                               |
|------------|---|
| LayerIndex | Layer index.                              |
| OnOff      | 1 for visible (default), 0 for invisible. |

#### Return value

0        on success  
1        on error.

#### Additional information

This function works properly only if the display driver callback function appropriately reacts to the command `LCD_X_SETVIS`. This in turn requires the display driver callback function to manage the appropriate SFRs accordingly. How to do this in detail is explained in the documentation of the display controller.

## 11.8.1.3 Configuration group

### 11.8.1.3.1 LCD\_SetBufferPtr()

#### Description

This function is used to set an array with buffer addresses for the currently selected layer. This allows incoherent buffers for multi-buffering.

#### Prototype

```
int LCD_SetBufferPtr(void ** pBufferPTR);
```

#### Parameters

| Parameter               | Description                                       |
|-------------------------|---|
| <code>pBufferPTR</code> | An array with addresses to the different buffers. |

#### Return value

0        on success  
1        on error.

#### Additional information

The number of entries in the array must fit to the numbers of buffers set for multi-buffering.

#### Example

```
...  
static const U32 _aBufferPTR[] = {  
    0x00000000, // Begin first buffer  
    0x00800000 // Begin second buffer  
};  
LCD_SetBufferPtr(_aBufferPTR);  
...
```

### 11.8.1.3.2 LCD\_SetBufferPtrEx()

#### Description

This function is used to set an array with buffer addresses for the layer with the given index. This allows incoherent buffers for multi-buffering.

#### Prototype

```
int LCD_SetBufferPtrEx(int    LayerIndex,  
                      void ** pBufferPTR);
```

#### Parameters

| Parameter                  | Description                                       |
|----------------------------|---|
| <a href="#">LayerIndex</a> | Index of the layer the buffers are for.           |
| <a href="#">pBufferPTR</a> | An array with addresses to the different buffers. |

#### Return value

0        on success  
1        on error.

#### Additional information

The number of entries in the array must fit to the numbers of buffers set for multi-buffering. [pBufferPTR](#) needs to stay valid as long as the emWin driver is in use.

### 11.8.1.3.3 LCD\_Off()

#### Description

Switches the currently selected display off.

#### Return value

|   |             |
|---|-------------|
| 0 | on success. |
| 1 | on error.   |

### 11.8.1.3.4 LCD\_OffEx()

#### Description

Switches the given display off.

#### Prototype

```
int LCD_OffEx(int LayerIndex);
```

#### Parameters

| Parameter  | Description                 |
|------------|-----------------------------|
| LayerIndex | Index of the layer/display. |

#### Return value

0        on success  
1        on error.



### 11.8.1.3.5 LCD\_On()

#### Description

Switches the currently selected display on.

#### Prototype

```
void LCD_On(void);
```

#### Return value

|   |             |
|---|-------------|
| 0 | on success. |
| 1 | on error.   |

### 11.8.1.3.6 LCD\_OnEx()

#### Description

Switches the given display on.

#### Prototype

```
int LCD_OnEx(int LayerIndex);
```

#### Parameters

| Parameter  | Description  |
|------------|--------------|
| LayerIndex | Layer index. |

#### Return value

0        on success  
1        on error.

### 11.8.1.3.7 LCD\_Refresh()

#### Description

Refreshes the currently selected layer by flushing the entire cache to the LCD.

#### Prototype

```
int LCD_Refresh(void);
```

#### Return value

0        on success  
1        on error.

#### Additional information

This function is only available when using a driver with a cache.

### 11.8.1.3.8 LCD\_RefreshEx()

#### Description

Refreshes the given layer by flushing the entire cache to the LCD.

#### Prototype

```
int LCD_RefreshEx(int LayerIndex);
```

#### Parameters

| Parameter                  | Description  |
|----------------------------|--------------|
| <a href="#">LayerIndex</a> | Layer index. |

#### Return value

0        on success  
1        on error.

#### Additional information

This function is only available when using a driver with a cache.

### 11.8.1.3.9 LCD\_SetDevFunc()

#### Description

The function sets additional and / or user defined functions of the display driver.

#### Prototype

```
int LCD_SetDevFunc(int LayerIndex,
                  int IdFunc,
                  void ( *pDriverFunc)());
```

#### Parameters

| Parameter   | Description                               |
|-------------|---|
| LayerIndex  | Layer index.                              |
| IdFunc      | See table below.                          |
| pDriverFunc | Pointer to function which should be used. |

| Permitted values for element IdFunc |  |
|-------------------------------------|--|
| LCD_DEVFUNC_COPYBUFFER              | Can be used to set a custom defined routine for copying buffers. Makes only sense in combination with multiple buffers.  |
| LCD_DEVFUNC_COPYRECT                | Can be used to set a custom defined routine for copying rectangular areas.   |
| LCD_DEVFUNC_DRAWBMP_1BPP            | Can be used to set a custom routine for drawing 1bpp bitmaps. Makes sense if a custom routine should be used for drawing text and 1bpp bitmaps.  |
| LCD_DEVFUNC_DRAWBMP_8BPP            | Can be used to set a custom routine for drawing 8bpp bitmaps. Makes sense if a custom routine should be used for drawing 8bpp bitmaps.   |
| LCD_DEVFUNC_FILLRECT                | Can be used to set a custom defined routine for filling rectangles. Makes sense if for example a BitBLT engine should be used for filling operations.<br>Can be used to set a custom defined routine for reading a single pixel from the display controller. |
| LCD_DEVFUNC_READMPIXELS             | Can be used to set a custom defined routine for reading multiple pixels from the display controller.   |
| LCD_DEVFUNC_READPIXEL               | Can be used to set a custom defined routine for reading a single pixel from the display controller.  |
| LCD_DEVFUNC_REFRESH                 | Can be used to set a custom defined routine for refreshing the LCD.  |

#### LCD\_DEVFUNC\_COPYBUFFER

Can be used to set up a function which copies a frame buffer to the desired location. This can make sense if for example a BitBLT engine is available to do the job. The function pointed by pDriverFunc should be of the following type:

```
void CopyBuffer(int LayerIndex,
               int IndexSrc,
               int IndexDst);
```

| Parameter                  | Description  |
|----------------------------|--|
| <a href="#">LayerIndex</a> | Layer index.   |
| <a href="#">IndexSrc</a>   | Index of the source frame buffer to be copied.           |
| <a href="#">IndexDst</a>   | Index of the destination frame buffer to be overwritten. |

## LCD\_DEVFUNC\_COPYRECT

Can be used to set up a function which copies a rectangular area of the screen to the desired location. This can make sense if for example a BitBLT engine is available to do the job. The function pointed by [pDriverFunc](#) should be of the following type:

```
void CopyRect(int LayerIndex,
             int x0,
             int y0,
             int x1,
             int y1,
             int xSize,
             int ySize);
```

| Parameter                  | Description                                  |
|----------------------------|--|
| <a href="#">LayerIndex</a> | Layer index.                                 |
| <a href="#">x0</a>         | Leftmost pixel of the source rectangle.      |
| <a href="#">y0</a>         | Topmost pixel of the source rectangle.       |
| <a href="#">x1</a>         | Leftmost pixel of the destination rectangle. |
| <a href="#">y1</a>         | Topmost pixel of the destination rectangle.  |
| <a href="#">xSize</a>      | X-size of the rectangle.                     |
| <a href="#">ySize</a>      | Y-size of the rectangle.                     |

## LCD\_DEVFUNC\_DRAWBMP\_1BPP

Can be used to set up a function which draws 1bpp bitmaps which includes also text. This can make sense if for example a BitBLT engine is available to do the job. The function pointed by [pDriverFunc](#) should be of the following type:

```
void DrawBMP1(int LayerIndex,
             int x,
             int y,
             U8 const * p,
             int Diff,
             int xSize,
             int ySize,
             int BytesPerLine,
             const LCD_PIXELINDEX * pTrans);
```

| Parameter                    | Description   |
|------------------------------|---|
| <a href="#">LayerIndex</a>   | Layer index.  |
| <a href="#">x</a>            | Leftmost coordinate in screen coordinates of the bitmap to be drawn.        |
| <a href="#">y</a>            | Topmost coordinate in screen coordinates of the bitmap to be drawn.         |
| <a href="#">p</a>            | Pointer to the pixel data of the bitmap.                                    |
| <a href="#">Diff</a>         | Offset to the first pixel pointed by parameter p. Supported values are 0-7. |
| <a href="#">xSize</a>        | X-size in pixels of the bitmap to be drawn.                                 |
| <a href="#">ySize</a>        | Y-size in pixels of the bitmap to be drawn.                                 |
| <a href="#">BytesPerLine</a> | Number of bytes of one line of bitmap data.                                 |

| Parameter           | Description   |
|---------------------|---|
| <code>pTrans</code> | Pointer to an array of color indices to be used to draw the bitmap data. The first color index defines the background color, the second color index defines the foreground color. |

### Return value

0 on success  
1 on error.

### Additional information

Please note that it depends on the display driver which values for parameter `IdFunc` are supported or not.

### LCD\_DEVFUNC\_DRAWBMP\_8BPP

Can be used to set up a function which draws 8bpp palette based bitmaps. This can make sense if for example a BitBLT engine is available to do the job. The function pointed by `pDriverFunc` should be of the following type:

```
void DrawBMP8(
    int LayerIndex,
    int x,
    int y,
    U8 const * p,
    int xSize,
    int ySize,
    int BytesPerLine,
    const LCD_PIXELINDEX * pTrans);
```

| Parameter                 | Description  |
|---------------------------|--|
| <code>LayerIndex</code>   | Layer index.   |
| <code>x</code>            | Leftmost coordinate in screen coordinates of the bitmap to be drawn.   |
| <code>y</code>            | Topmost coordinate in screen coordinates of the bitmap to be drawn.  |
| <code>p</code>            | Pointer to the pixel data of the bitmap.   |
| <code>xSize</code>        | X-size in pixels of the bitmap to be drawn.  |
| <code>ySize</code>        | Y-size in pixels of the bitmap to be drawn.  |
| <code>BytesPerLine</code> | Number of bytes of one line of bitmap data.  |
| <code>pTrans</code>       | Pointer to an array of color indices to be used to draw the bitmap data. These colors are addressed by the index values of the pixels. |

### Return value

0 on success  
1 on error.

### Additional information

Please note that it depends on the display driver which values for parameter `IdFunc` are supported or not.

### LCD\_DEVFUNC\_FILLRECT

Can be used to set a custom function for filling operations. The function pointed by `pDriverFunc` should be of the following type:

```
void FillRect(int LayerIndex,
             int x0,
```

```

int y0,
int x1,
int y1,
U32 PixelIndex);

```

| Parameter               | Description   |
|-------------------------|---|
| <code>LayerIndex</code> | Layer index.  |
| <code>x0</code>         | Leftmost coordinate to be filled in screen coordinates.   |
| <code>y0</code>         | Topmost coordinate to be filled in screen coordinates.    |
| <code>x1</code>         | Rightmost coordinate to be filled in screen coordinates.  |
| <code>y1</code>         | Bottommost coordinate to be filled in screen coordinates. |
| <code>PixelIndex</code> | Color index to be used to fill the specified area.        |

### LCD\_DEVFUNC\_READMPIXELS

Can be used to set a custom defined routine for reading multiple pixels from the display controller. The function pointed by `pDriverFunc` should be one of the following types:

```

void _ReadMPixels(int LayerIndex,
                  U16 * pBuffer,
                  U32 NumPixels);

void _ReadMPixels(int LayerIndex,
                  U32 * pBuffer,
                  U32 NumPixels);

```

| Parameter               | Description   |
|-------------------------|---|
| <code>LayerIndex</code> | Layer index.  |
| <code>pBuffer</code>    | Pointer to the buffer in which the pixel data has to be stored. |
| <code>NumPixels</code>  | Number pixels to read.  |

The required function type depends on the configured color depth of the display driver. In 16bpp mode a `U16` pointer is required for the buffer and for 18bpp up to 32bpp a `U32` pointer is required.

### LCD\_DEVFUNC\_READPIXEL

Can be used to set a custom defined routine for reading a single pixel from the display controller. The function pointed by `pDriverFunc` should be one of the following types:

```

U16 _ReadPixel(int LayerIndex);

U32 _ReadPixel(int LayerIndex);

```

| Parameter               | Description  |
|-------------------------|--------------|
| <code>LayerIndex</code> | Layer index. |

The required type of the return value depends on the configured color depth of the display driver. In 16bpp mode `U16` is required and for 18bpp up to 32bpp `U32` is required.



### 11.8.1.3.10 LCD\_SetMaxNumColors()

#### Description

Sets the maximum number of colors used in palette based bitmaps.

#### Prototype

```
int LCD_SetMaxNumColors(unsigned MaxNumColors);
```

#### Parameters

| Parameter                 | Description   |
|---------------------------|---|
| <code>MaxNumColors</code> | Maximum number of colors used in palette based bitmaps. Default is 256. |

#### Return value

0        on success  
1        on error.

#### Additional information

During the process of initialization emWin allocates a buffer required for converting color values of the bitmaps into index values for the controller. This buffer requires 4 bytes per color. If the system is short on RAM and only a few colors are used, this function could spare up to 1016 bytes of dynamically RAM. Per default the buffer uses 1024 bytes of RAM. But if for example only 2 colors are used (typically b/w-configuration) only 8 bytes for 2 colors are required. The function needs to be called by the routine `GUI_X_Config()`.

### 11.8.1.3.11 LCD\_SetSizeEx()

#### Description

Sets the physical size of the visible area of the given display/layer.

#### Prototype

```
int LCD_SetSizeEx(int LayerIndex,  
                 int xSize,  
                 int ySize);
```

#### Parameters

| Parameter                  | Description  |
|----------------------------|--|
| <a href="#">LayerIndex</a> | Layer index.   |
| <a href="#">xSize</a>      | X-Size in pixels of the visible area of the given layer. |
| <a href="#">ySize</a>      | Y-Size in pixels of the visible area of the given layer. |

#### Return value

0        on success  
1        on error.

#### Additional information

The function requires a display driver which is able to manage dynamically changes of the display size. If the display driver does not support this feature the function fails.

### 11.8.1.3.12 LCD\_SetVRAMAddrEx()

#### Description

Sets the address of the video RAM.

#### Prototype

```
int LCD_SetVRAMAddrEx(int LayerIndex,  
                      void * pVRAM);
```

#### Parameters

| Parameter  | Description                            |
|------------|--|
| LayerIndex | Layer index.                           |
| pVRAM      | Pointer to start address of video RAM. |

#### Return value

0 on success  
1 on error.

#### Additional information

The function requires a display driver which is able to manage dynamically changes of the video RAM address. If the display driver does not support this feature the function fails.

### 11.8.1.3.13 LCD\_SetVSizeEx()

#### Description

Sets the size of the virtual display area.

#### Prototype

```
int LCD_SetVSizeEx(int LayerIndex,  
                  int xSize,  
                  int ySize);
```

#### Parameters

| Parameter                  | Description  |
|----------------------------|--|
| <a href="#">LayerIndex</a> | Layer index.   |
| <a href="#">xSize</a>      | X-Size in pixels of the virtual area of the given layer. |
| <a href="#">ySize</a>      | Y-Size in pixels of the virtual area of the given layer. |

#### Return value

0        on success.  
1        on error.

#### Additional information

The function requires a display driver which is able to manage dynamically changes of the virtual display size. If the display driver does not support this feature the function fails.

## 11.8.1.4 Cache group

### 11.8.1.4.1 LCD\_ControlCache()

#### Description

Locks, unlocks and flushes the cache of the display controller if it is supported.

#### Prototype

```
int LCD_ControlCache(int Cmd);
```

#### Parameters

| Parameter        | Description      |
|------------------|------------------|
| <code>Cmd</code> | See table below. |

| Permitted values for element <code>Cmd</code> |  |
|---|--|
| <code>LCD_CC_FLUSH</code>                     | Flushes the cache. The content of the cache which has changed since the last flushing operation is output to the display.    |
| <code>LCD_CC_LOCK</code>                      | Locks the cache. Drawing operations are cached, but not output to the display.   |
| <code>LCD_CC_UNLOCK</code>                    | Unlocks the cache. The cached data is flushed immediately. Further drawing operations are cached and output. (Write Through) |

#### Return value

0        on success  
1        on error.

#### Additional information

The function requires a display driver which is able to manage dynamically changes of the virtual display size. If the display driver does not support this feature the function fails. This function is automatically used for drawing operations of windows and strings.

# Chapter 12

## Touch drivers

---

A touch driver supports a particular family of touch controllers and all touch pads which are connected to one of these controllers. The drivers can be configured by modifying their configuration files whereas the driver itself does not need to be modified. The configuration files contain all required information for the driver including how the hardware is accessed and how the controller(s) are connected to the display. This chapter provides an overview of the touch drivers available for emWin. It explains the following in terms of each driver:

- Which touch controllers can be accessed and which interface can be used.
- RAM requirements.
- Driver specific functions.
- How to access the hardware.
- Special configuration switches.
- Special requirements for particular touch controllers.

## 12.1 GUIMTDRV\_TangoC32

The driver is written for the multi touch controller TangoC32 from PIXCIR. It is delivered along with the emWin MultiTouch feature.

The controller can be accessed via I2C interface. It provides an interrupt line which needs to be used by the application to generate an interrupt. Once the driver has been initialized right it automatically fills up the multi touch buffer of emWin.

### 12.1.1 Supported hardware

This driver works with the following controller:

- PIXCIR Tango C32

### 12.1.2 Driver initialization

A good place for initializing the touch driver is the routine `LCD_X_Config()`. This makes sure, that the touch driver and the display driver has been initialized before emWin is used by the application.

#### First part

The first part of initializing the driver is calling the drivers configuration function. It sets up the function pointers for hardware communication.

#### Second part

To be able to do its work the drivers execution function needs to be called when touching the screen. That should be done via interrupt routine. For that case the touch controller provides an interrupt line which is active if a touch event occurs. The one and only thing which then should be done in the interrupt routine is calling the drivers execution function `GUIMTDRV_TangoC32_Exec()`.

### 12.1.3 GUIMTDRV\_TangoC32 API

The following table shows the available functions of the driver.

| Routine                               | Description             |
|---------------------------------------|-------------------------|
| <code>GUIMTDRV_TangoC32_Init()</code> | Configuration function. |
| <code>GUIMTDRV_TangoC32_Exec()</code> | Execution function.     |

### 12.1.3.1 GUIMTDRV\_TangoC32\_Init()

#### Description

Passes a pointer to a `GUIMTDRV_TANGOC32_CONFIG` structure to the driver. This structure contains all required function pointers and values required by the driver.

#### Prototype

```
int GUIMTDRV_TangoC32_Init(GUIMTDRV_TANGOC32_CONFIG * pConfig);
```

#### Parameters

| Parameter            | Description   |
|----------------------|---|
| <code>pConfig</code> | Pointer to a <code>GUIMTDRV_TANGOC32_CONFIG</code> structure described below. |

#### Elements of structure `GUIMTDRV_TANGOC32_CONFIG`

| Data type   | Element                    |
|---|----------------------------|
| <code>void (*)(U8 SlaveAddr)</code>                                 | <code>pf_I2C_Init</code>   |
| <code>int (*)(U8 * pData, int Start, int Stop)</code>               | <code>pf_I2C_Read</code>   |
| <code>int (*)(U8 * pData, int NumItems, int Start, int Stop)</code> | <code>pf_I2C_ReadM</code>  |
| <code>int (*)(U8 Data, int Start, int Stop)</code>                  | <code>pf_I2C_Write</code>  |
| <code>int (*)(U8 * pData, int NumItems, int Start, int Stop)</code> | <code>pf_I2C_WriteM</code> |
| <code>U8</code>   | <code>SlaveAddr</code>     |

#### `pf_I2C_Init()`

| Parameter              | Description                                       |
|------------------------|---|
| <code>SlaveAddr</code> | I2C Slave address of touch controller to be used. |

That pointer should point to a function which initializes the I2C communication. The element `SlaveAddr` is passed to the given function to set up the slave address of the touch controller device (normally `0x5C`).

#### `pf_I2C_Read()`

| Parameter          | Description  |
|--------------------|--|
| <code>pData</code> | Pointer to an unsigned character to store the byte.                                |
| <code>Start</code> | Is set to 1 if bus communication starts, otherwise 0.                              |
| <code>Stop</code>  | Is set to 1 if bus communication should end after the read operation, otherwise 0. |

That function is responsible for reading one byte of data. The given pointer `pData` is used to store the value.

Returns 0 on success, otherwise 1.

#### `pf_I2C_ReadM()`

| Parameter             | Description  |
|-----------------------|--|
| <code>pData</code>    | Pointer to a buffer to be filled by the routine.                                   |
| <code>NumItems</code> | Number of bytes to be read.  |
| <code>Start</code>    | Is set to 1 if bus communication starts, otherwise 0.                              |
| <code>Stop</code>     | Is set to 1 if bus communication should end after the read operation, otherwise 0. |



That function is responsible for reading multiple bytes of data. The given pointer `pData` is used to store the value.

Returns 0 on success, otherwise 1.

### pf\_I2C\_Write()

| Parameter          | Description   |
|--------------------|---|
| <code>Data</code>  | Byte to be written.   |
| <code>Start</code> | Is set to 1 if bus communication starts, otherwise 0.                               |
| <code>Stop</code>  | Is set to 1 if bus communication should end after the write operation, otherwise 0. |

That function is responsible for writing one byte of data.

Returns 0 on success, otherwise 1.

### pf\_I2C\_WriteM()

| Parameter             | Description   |
|-----------------------|---|
| <code>pData</code>    | Pointer to buffer to be written.  |
| <code>NumItems</code> | Number of bytes to be written.  |
| <code>Start</code>    | Is set to 1 if bus communication starts, otherwise 0.                               |
| <code>Stop</code>     | Is set to 1 if bus communication should end after the write operation, otherwise 0. |

That function is responsible for writing multiple bytes of data. The given pointer `pData` is used to store the value.

### Return value

Returns 0 on success, otherwise 1.

## 12.2 GUITDRV\_ADS7846

### 12.2.1 Supported hardware

This driver works with the following controller:

- Texas Instruments ADS7846 touch screen controller

### 12.2.2 Driver initialization

A good place for initializing the touch driver is the routine `LCD_X_Config()`. This makes sure, that the touch driver and the display driver has been initialized before `emWin` is used by the application.

#### First part

The first part of initializing the driver is calling the drivers configuration function. It sets up the following things:

- Function pointers for hardware communication routines
- Touch panel orientation to be used
- Logical and physical AD values to be able to calculate the right position depending on the AD values of the controller

#### Second part

To be able to do its work the drivers execution function needs to be called periodically. We recommend an interval of 20-30 ms. The function call can be done from within a timer interrupt routine or from a separate task.

### 12.2.3 GUITDRV\_ADS7846 API

The following table shows the available functions of the driver.

| Routine                                   | Description                       |
|---|-----------------------------------|
| <code>GUITDRV_ADS7846_Config()</code>     | Configuration function.           |
| <code>GUITDRV_ADS7846_Exec()</code>       | Execution function.               |
| <code>GUITDRV_ADS7846_GetLastVal()</code> | Retrieves the last stored values. |

### 12.2.3.1 GUITDRV\_ADS7846\_Config()

#### Description

Passes a pointer to a GUITDRV\_ADS7846\_CONFIG structure to the driver. This structure contains all required function pointers and values required by the driver.

#### Prototype

```
void GUITDRV_ADS7846_Config(GUITDRV_ADS7846_CONFIG * pConfig);
```

#### Parameters

| Parameter            | Description  |
|----------------------|--|
| <code>pConfig</code> | Pointer to a GUITDRV_ADS7846_CONFIG structure described below. |

| Permitted values for element Orientation |                        |
|--|------------------------|
| GUI_MIRROR_X                             | Mirroring the X-axis   |
| GUI_MIRROR_Y                             | Mirroring the Y-axis   |
| GUI_SWAP_XY                              | Swapping X- and Y-axis |

| Data type                         | Element                  | Description   |
|-----------------------------------|--------------------------|---|
| <code>void (*)(U8 Data)</code>    | <code>pfSendCmd</code>   | Hardware routine for sending a byte to the controller via its SPI interface.  |
| <code>U16 (*)(void)</code>        | <code>pfGetResult</code> | Hardware routine for getting the AD conversion result of the controller via its SPI interface. The driver uses the 12 bit conversion mode. Per conversion the controller uses 16 clocks. Only the first 12 bits contain the result to be returned by this routine.  |
| <code>char (*)(void)</code>       | <code>pfGetBusy</code>   | Hardware routine for getting the busy state of the controller. The routine should return 1 if the controller is busy and 0 if not.  |
| <code>void (*)(char OnOff)</code> | <code>pfSetCS</code>     | Routine for toggling the CS signal of the controller. When receiving 1 the signal should become high and vice versa.  |
| <code>unsigned</code>             | Orientation              | One or more "OR" combined values of the table below.  |
| <code>int</code>                  | <code>xLog0</code>       | Logical X value 0 in pixels.  |
| <code>int</code>                  | <code>xLog1</code>       | Logical X value 1 in pixels.  |
| <code>int</code>                  | <code>xPhys0</code>      | A/D converter value for <code>xLog0</code> .  |
| <code>int</code>                  | <code>xPhys1</code>      | A/D converter value for <code>xLog1</code> .  |
| <code>int</code>                  | <code>yLog0</code>       | Logical Y value 0 in pixels.  |
| <code>int</code>                  | <code>yLog1</code>       | Logical Y value 1 in pixels.  |
| <code>int</code>                  | <code>yPhys0</code>      | A/D converter value for <code>yLog0</code> .  |
| <code>int</code>                  | <code>yPhys1</code>      | A/D converter value for <code>yLog1</code> .  |
| <code>char (*)(void)</code>       | <code>pfGetPENIRQ</code> | If the PENIRQ line of the touch controller is connected to a port of the target hardware a touch event can be detected by the driver. Upon polling the driver's exec routine the driver can check if a touch event is ready to be sampled by checking the PENIRQ line. Without PENIRQ line the driver will always try to sample |

| Data type | Element          | Description   |
|-----------|------------------|---|
|           |                  | <p>a touch event even if no touch happened which will consume time even if not necessary. Without PENIRQ it is the responsibility of the user's <code>pfGetResult()</code> routine to return <code>0xFFFF</code> if the measured AD value is out of bounds. If both, the PENIRQ and the touch pressure recognition are enabled first the PENIRQ will signal that there is a touch event. Afterwards the touch pressure measurement is used to confirm that this was a valid touch and the touch had enough pressure to deliver good measurements.</p> <p>The routine should return 1 if a touch event is recognized and 0 if not.</p> |
| int       | PressureMin      | Minimum pressure threshold. A measured pressure below this value means we do not have a valid touch event.  |
| int       | PressureMax      | Maximum pressure threshold. A measured pressure above this value means we do not have a valid touch event.  |
| int       | PlateResistanceX | Resistance of the X-plate of the touch screen. This value is needed for calculation of the touch pressure.  |

### 12.2.3.2 GUITDRV\_ADS7846\_Exec()

#### Description

Execution function of the touch driver.

#### Prototype

```
char GUITDRV_ADS7846_Exec(void);
```

#### Return value

- 0 No update has occurred.
- 1 Touch has been updated.

#### Additional information

We recommend to call the routine each 20-30 ms. If the routine detects a valid touch event it stores the result into the touch buffer via a function call to `GUI_TOUCH_StoreStateEx()`. Please note that the driver needs some function pointers to be filled correctly to be able to communicate with the external peripheral. The correct assignment of these function pointers is checked during driver configuration and leads to an abort to `GUI_ErrorOut()` on missing pointers.

### 12.2.3.3 GUITDRV\_ADS7846\_GetLastVal()

#### Description

Retrieves the last stored values for some internal variables that might be needed for calibration of the driver without knowing its internals.

#### Prototype

```
void GUITDRV_ADS7846_GetLastVal(GUITDRV_ADS7846_LAST_VAL * p);
```

#### Parameters

| Parameter      | Description                                      |
|----------------|--|
| <code>p</code> | Pointer to a GUITDRV_ADS7846_LAST_VAL structure. |

#### Elements of structure GUITDRV\_ADS7846\_LAST\_VAL

| Data type | Element  | Description   |
|-----------|----------|---|
| int       | xPhys    | Last measured x value   |
| int       | yPhys    | Last measured y value   |
| int       | z1Phys   | Last measured z1 value  |
| int       | z2Phys   | Last measured z2 value  |
| int       | PENIRQ   | Last sampled PENIRQ state if PENIRQ callback has been set             |
| int       | Pressure | Last measured touch pressure if touch pressure measurement is enabled |

#### Additional information

This function is an optional function and not required to be able to use the driver.

# Chapter 13

## Performance and Resource Usage

---

High performance combined with low resource usage has always been a major design consideration. emWin runs on 8/16/32-bit CPUs. Depending on which modules are being used, even single-chip systems with less than 64 KB ROM and 2 KB RAM can be supported by emWin. The actual performance and resource usage depends on many factors (CPU, compiler, memory model, optimization, configuration, display controller interface, etc.). This chapter contains benchmarks and information about resource usage in typical systems which can be used to obtain sufficient estimates for most target systems.

## 13.1 Performance

The following chapter shows driver benchmarks on different targets and performance values of image drawing operations.

### 13.1.1 Driver benchmark

We use a benchmark test to measure the speed of the display drivers on available targets. This benchmark is in no way complete, but it gives an approximation of the length of time required for common operations on various targets.

#### Configuration and performance table

| CPU                  | LCD Controller (GUIDRV_...) | bpp | Bench1 Filling | Bench2 Small fonts | Bench3 Bit fonts | Bench4 Bitmap 1bpp | Bench5 Bitmap 2bpp | Bench6 Bitmap 4bpp | Bench7 Bitmap 8bpp | Bench8 DDP bitmap |
|----------------------|-----------------------------|-----|----------------|--------------------|------------------|--------------------|--------------------|--------------------|--------------------|-------------------|
| <b>ARM Cortex-A9</b> |                             |     |                |                    |                  |                    |                    |                    |                    |                   |
| RZA1 (360MHz)        | (internal) ...LIN16         | 16  | 335M           | 15.9M              | 21.8M            | 32.6M              | 21.2M              | 19.8M              | 10.0M              | 62.4M             |
| RZA1 (360MHz)        | (internal) ...LIN32         | 32  | 182M           | 14.0M              | 20.3M            | 25.7M              | 24.2M              | 22.7M              | 12.7M              | 69.1M             |
| <b>ARM Cortex-M4</b> |                             |     |                |                    |                  |                    |                    |                    |                    |                   |
| ST-M32F429 (168MHz)  | (internal) ...LIN8          | 8   | 182M           | 2.74M              | 3.67M            | 5.67M              | 2.02M              | 1.94M              | 2.30M              | 21.4M             |
| ST-M32F429 (168MHz)  | (internal) ...LIN16         | 16  | 131M           | 3.65M              | 5.19M            | 7.68M              | 4.08M              | 3.89M              | 20.64M             | 25.59M            |
| ST-M32F429 (168MHz)  | (internal) ...LIN32         | 32  | 67.7M          | 3.65M              | 5.22M            | 7.80M              | 5.68M              | 5.14M              | 20.98M             | 20.11M            |
| ST-M32F407 (168MHz)  | (external) FLEXCOLOR *1     | 16  | 5.9M           | 1.14M              | 1.75M            | 2.52M              | 2.04M              | 1.94M              | 1.14M              | 5.67M             |
| MK66FN2 (168MHz)     | (external) FLEXCOLOR *2     | 16  | 981.35K        | 504.36K            | 564.5K           | 635.68K            | 616.09K            | 604.03K            | 560.38K            | 876.54K           |
| <b>ARM720T</b>       |                             |     |                |                    |                  |                    |                    |                    |                    |                   |
| ARM720T (50MHz)      | (internal) (3200)           | 16  | 7.14M          | 581K               | 1.85M            | 1.96M              | 694K               | 645K               | 410K               | 2.94M             |
| <b>ARM9</b>          |                             |     |                |                    |                  |                    |                    |                    |                    |                   |
| AR-M926EJ-S (200MHz) | (internal) (3200)           | 16  | 123M           | 3.79M              | 5.21M            | 7.59M              | 2.27M              | 2.21M              | 1.77M              | 15.2M             |

#### Legend

- **M** - Megapixels per second
- **K** - Kilopixels per second
- \*1 - 16 bit parallel interface
- \*2 - 8 bit serial interface



**Bench1: Filling**

Bench the speed of filling. An area of 64×64 pixels is filled with different colors.

**Bench2: Small fonts**

Bench the speed of small character output. An area of 60×64 pixels is filled with small-character text.

**Bench3: Big fonts**

Bench the speed of big character output. An area of 65×48 pixels is filled with big-character text.

**Bench4: Bitmap 1bpp**

Bench the speed of 1bpp bitmaps. An area of 58×8 pixels is filled with a 1bpp bitmap.

**Bench 5: Bitmap 2bpp**

Bench the speed of 2bpp bitmaps. An area of 32×11 pixels is filled with a 2bpp bitmap.

**Bench6: Bitmap 4bpp**

Bench the speed of 4bpp bitmaps. An area of 32×11 pixels is filled with a 4bpp bitmap.

**Bench7: Bitmap 8bpp**

Bench the speed of 8bpp bitmaps. An area of 32×11 pixels is filled with a 8bpp bitmap.

**Bench8: Device-dependent bitmap, 8 or 16 bpp**

Bench the speed of bitmaps 8 or 16 bits per pixel. An area of 64 pixels is filled with a bitmap. The color depth of the tested bitmap depends on the configuration. For configurations ≤ 8bpp, a bitmap with 8 bpp is used; 16bpp configurations use a 16-bpp bitmap.

## 13.1.2 Image drawing performance

The purpose of the following table is to show the drawing performance of the various image formats supported by emWin. The measurement for the following table has been done on an ARM Cortex-A9 (RZA1H) running with 360MHz and with 16bpp display color depth using GUIDRV\_LIN\_16:

| Image format   | Megapixels per second |
|--|-----------------------|
| Internal bitmap format: 1bpp C file                  | 47.5                  |
| Internal bitmap format: 4bpp C file                  | 27.5                  |
| Internal bitmap format: 8bpp C file                  | 41.6                  |
| Internal bitmap format: 16bpp C file, high color     | 103                   |
| Internal bitmap format: 24bpp C file, true color 888 | 8.0                   |
| Internal bitmap format: RLE4 C file                  | 14.5                  |
| Internal bitmap format: RLE8 C file                  | 16.4                  |
| Internal bitmap format: RLE16 C file                 | 10.3                  |
| BMP file 8bpp  | 44.6                  |
| BMP file 16bpp                                       | 4.6                   |
| BMP file 24bpp                                       | 5.7                   |
| BMP file 32bpp                                       | 5.6                   |
| BMP file RLE4  | 32.9                  |
| BMP file RLE8  | 23.2                  |

| Image format                 | Megapixels per second |
|------------------------------|-----------------------|
| GIF file                     | 4.1                   |
| JPEG file, H1V1              | 1.3                   |
| JPEG file, H1V1, progressive | 1.1                   |
| JPEG file, H2V2              | 1.8                   |
| JPEG file, H2V2, progressive | 1.5                   |

## 13.2 Memory requirements

The operation area of emWin varies widely, depending primarily on the application and features used. In the following sections, memory requirements of different modules are listed as well as memory requirement of example applications. The memory requirements of the GUI components have been measured on a system as follows:

- ARM7
- IAR Embedded Workbench V4.42A
- Thumb mode
- Size optimization

### 13.2.1 Memory requirements of the GUI components

The following table shows the memory requirements of the main components of emWin. These values depend a lot on the compiler options, the compiler version and the used CPU. Note that the listed values are the requirements of the basic functions of each module and that there are several additional functions available which have not been considered in the table:

| Component       | ROM               | RAM                | Description   |
|-----------------|-------------------|--------------------|---|
| Window Manager  | + 6.2 KB          | + 2.5 KB           | Additional memory requirements of a 'Hello world' application when using the Window Manager.  |
| Memory Devices  | + 4.7 KB          | + 7 KB             | Additional memory requirements of a 'Hello world' application when using Memory Devices.  |
| Antialiasing    | + 4.5 KB          | + 2 *<br>LCD_XSIZE | Additional memory requirements for the anti-aliasing software item.   |
| Driver          | + 2 - 8 KB        | 20 Bytes           | The memory requirements of the driver depend on the configured driver and if a data cache is used or not. With a data cache, the driver requires more RAM. For details, refer to the chapter <i>Display drivers</i> on page 2927. |
| MultiLayer      | + 2 - 8 KB        | -                  | If working with a MultiLayer or a Multi-Display configuration additional memory for each additional layer is required, because each layer requires its own driver.  |
| Core            | 5.2 KB            | 80 Bytes           | Memory requirements of a typical 'Hello world' application without using additional software items.   |
| Core / JPEG     | 12 KB             | 38 KB              | Basic routines for drawing JPEG files.  |
| Core / GIF      | 3.3 KB            | 17 KB              | Basic routines for drawing GIF files.   |
| Core / Sprites  | 4.7 KB            | 16 Bytes           | Routines for drawing sprites and cursors.   |
| Core / Fonts    | (see description) | -                  | Details of the ROM requirements of the standard fonts shipped with emWin can be found in the chapter <i>Fonts</i> on page 525.  |
| Widgets         | 4.5 KB            | -                  | This is the approximately basic ROM requirement for the widgets depending on the individual core functions used by the widgets.   |
| Widget / BUTTON | 1 KB              | 40 Bytes           | *1  |

| Component              | ROM    | RAM      | Description |
|------------------------|--------|----------|-------------|
| Widget / CHECKBOX      | 1 KB   | 52 Bytes | *1          |
| Widget / DROPDOWN      | 1.8 KB | 52 Bytes | *1          |
| Widget / EDIT          | 2.2 KB | 28 Bytes | *1          |
| Widget / FRAMEWIN      | 2.2 KB | 12 Bytes | *1          |
| Widget / GRAPH         | 2.9 KB | 48 Bytes | *1          |
| Widget / GRAPH_DATA_XY | 0.7 KB | -        | *1          |
| Widget / GRAPH_DATA_YT | 0.6 KB | -        | *1          |
| Widget / HEADER        | 2.8 KB | 32 Bytes | *1          |
| Widget / LISTBOX       | 3.7 KB | 56 Bytes | *1          |
| Widget / LISTVIEW      | 3.6 KB | 44 Bytes | *1          |
| Widget / MENU          | 5.7 KB | 52 Bytes | *1          |
| Widget / MULTIEDIT     | 7.1 KB | 16 Bytes | *1          |
| Widget / MULTIPAGE     | 3.9 KB | 32 Bytes | *1          |
| Widget / PROGBAR       | 1.3 KB | 20 Bytes | *1          |
| Widget / RADIOBUTTON   | 1.4 KB | 32 Bytes | *1          |
| Widget / SCROLLBAR     | 2 KB   | 14 Bytes | *1          |
| Widget / SLIDER        | 1.3 KB | 16 Bytes | *1          |
| Widget / TEXT          | 0.4 KB | 16 Bytes | *1          |

### Legend

**1.** The listed memory requirements of the widgets contain the basic routines required for creating and drawing the widget. Depending on the specific widget there are several additional functions available which are not listed in the table.

## 13.2.2 Stack requirements

The basic stack requirement is approximately 600 bytes. If using the Window Manager additional 600 bytes should be calculated. For Memory Devices further additional 200 bytes are recommended. Please note that the stack requirement also depends on the application, the used compiler and the CPU.

## 13.3 Memory requirements of example applications

This section shows the requirements of some example applications. The following table contains the summary of the memory requirements. The values are in bytes unless specified differently:

| Example            | GUI core | Fonts   | Application | Startup code | Library | Total         | GUI core | Application | Stack  | Total         |
|--------------------|----------|---------|-------------|--------------|---------|---------------|----------|-------------|--------|---------------|
|                    | ROM      |         |             |              |         | RAM           |          |             |        |               |
| Hello world        | 5.9 kB   | 1.8 kB  | 38 B        | 0.3 kB       | 0.1 kB  | <b>8.1 kB</b> | 62 B     | -           | 272 B  | <b>334 B</b>  |
| Window application | 43 kB    | 12.5 kB | 2.7 kB      | 0.3 kB       | 1.5 kB  | <b>60 kB</b>  | 5.2 kB   | 40 B        | 1.4 kB | <b>6.6 kB</b> |

For details about the examples, refer to the following sections.

## 13.4 Optimizing footprint

The amount of RAM and ROM required by emWin could be optimized in some cases. This chapter shows when it is possible to spare some RAM and/or ROM and how that could be achieved.

### 13.4.1 Optimizing RAM requirement

In general the application should not allocate much more memory as required by the application. But unfortunately it is not possible providing a simple formula which can be used for that. If the simulation is used it is possible to open a window which shows the current amount of used/free memory of the executing application by right-clicking the simulation window. For details please also refer to *View system info* on page 171. All of the below shown RAM optimizations can be done with a precompiled library.

#### Systems using bitmaps with less than 256 colors

If less than 256 colors are used by bitmaps the size of the buffer required for bitmap palette conversion could be reduced. Per default palettes with up to 256 colors can be converted. That requires  $256 * 4 = 1024$  bytes. If the bitmaps used by the application use less than 256 colors the size of the buffer could be reduced. That could be done by calling the function `LCD_SetMaxNumColors()` with the maximum number of colors used by bitmaps. Details can be found in the description of `LCD_SetMaxNumColors` on page 3133.

#### Systems using a display driver with indirect interface

If the system is short on RAM and a driver with indirect interface is used it is recommended not to use a display driver cache. If the display controller supports reading back frame buffer data it should be possible to use the driver without a cache. Details about cache configuration can be found in the respective display driver description.

#### Systems using multi tasking support (GUI\_OS == 1)

If multiple tasks are configured emWin uses a maximum of 4 tasks per default. That requires approx. 110 bytes per task which makes  $4 * 110 = 440$  bytes. If less than 4 GUI-tasks are used that can be done by fine tuning the maximum number of tasks by calling the function `GUI_TASK_SetMaxTask()` from `GUI_X_Config()`. For details please also refer to the function `GUI_TASK_SetMaxTask` on page 111.

### 13.4.2 Optimizing ROM requirement

In general here can not be done much on emWin side. But may some features could be disabled which spare a few KByte of ROM requirement. The below shown optimizations can only be done when compiling the source code of emWin.

#### Using the Window Manager without transparent windows

If the application does not require transparent windows the source of emWin can be compiled with the following option set in the configuration file `GUIConf.h`:

```
#define WM_SUPPORT_TRANSPARENCY 0
```

#### Disable text rotation

If the application does not use the functions for drawing rotated text the code required for that operations can be disabled by inserting the following define in the configuration file `GUIConf.h`:

```
#define GUI_SUPPORT_ROTATION 0
```

### 13.4.3 Features with appreciable additional RAM requirement

The following table shows the features requiring additional RAM:

| Module                         | Description  |
|--------------------------------|--|
| Language module (GUI_LANG_...) | The amount of additional RAM requirement depends on the kind of use of the language model and on the size of the text files used.  |
| Alpha blending                 | If alpha blending is used the module automatically allocates 3 buffers with the maximum virtual display size in x and a color depth of 32 bpp.   |
| Orientation device             | If a driver does not support changing the display orientation the orientation device could be used. But please note that this device uses a much memory as required to hold a copy of the complete frame buffer. |

This table does not contain the RAM requirement of each single module but shows the most appreciable ones.

# Chapter 14

## Support

---

This chapter should help if any problem occurs. This could be a problem with the tool chain, with the hardware, the use of the GUI functions or with the performance and it describes how to contact emWin support.



## 14.1 Problems with tool chain (compiler, linker)

The following shows some of the problems that can occur with the use of your tool chain. The chapter tries to show what to do in case of a problem and how to contact the emWin support if needed.

### 14.1.1 Compiler crash

You ran into a tool chain (compiler) problem, not a problem of emWin. If one of the tools of your tool chain crashes, you should contact your compiler support:

```
"Tool internal error, please contact support"
```

### 14.1.2 Compiler warnings

The code of emWin has been tested on different target systems and with different compilers. We spend a lot of time on improving the quality of the code and we do our best to avoid compiler warnings. But the sensitivity of each compiler regarding warnings is different. So we can not avoid compiler warnings for unknown tools.

#### Warnings you should not see

These kinds of warnings should not occur:

```
"Function has no prototype"  
"Incompatible pointer types"  
"Variable used without having been initialized"  
"Illegal redefinition of macro"
```

#### Warnings you may see

Warnings such as the ones below should be ignored:

```
"Integer conversion, may lose significant bits"  
"Statement not reached"  
"Descriptionless statements were deleted during optimization"  
"Condition is always true/false"  
"Unreachable code"
```

Most compilers offer a way to suppress selected warnings.

#### Warning "Parameter not used"

Depending of the used configuration sometimes not all of the parameters of the functions are used. To avoid compiler warnings regarding this problem you can define the macro `GUI_USE_PARA` in the file `GUIConf.h` like the following example:

```
#define GUI_USE_PARA(para) (void)para
```

emWin uses this macro wherever necessary to avoid this type of warning.

### 14.1.3 Compiler errors

emWin assumes that the used compiler is ANSI C compatible. The compiler should cover at least one of the following standards:

- ISO/IEC/ANSI 9899:1990 (C90) with support for C++ style comments (//)
- ISO/IEC 9899:1999 (C99)
- ISO/IEC 14882:1998 (C++)

## Limited number of arguments in a function pointer call

But some compilers are not 100% ANSI C compatible and have for example a limitation regarding the number of arguments in a function pointer call:

```
typedef int tFunc(int a, int b, int c, int d, int e,
                 int f, int g, int h, int i, int j);
static int _Func(int a, int b, int c, int d, int e,
                int f, int g, int h, int i, int j) {
    return a + b + c + d + e + f + g + h;
}
static void _Test(void) {
    int Result;
    tFunc * pFunc;
    pFunc = _Func;
    Result = pFunc(1, 2, 3, 4, 5, 6, 7, 8, 9, 10);
}
```

If the example above can not be compiled, only the core version of emWin can be used. The additional packages of emWin like the Window Manager or the Memory Device module sometimes need to pass up to 10 parameters with a function pointer call. The core package of emWin needs only up to 2 parameters in a function pointer call. But you can also use emWin if your compiler only supports one argument in a function pointer call. If so some functions are not available, for example rotating text or UTF-8 encoding.

## 14.1.4 Linker problems

### Undefined externals

If your linker shows the error message "Undefined external symbols...", check if the following files have been included to the project or library:

- All source files shipped with emWin
- In case of a simple bus interface: One of the hardware routines located in the folder **Sample\LCD\_X\_Port**. For details about this, refer to the chapter *Configuration* on page 100.
- One of the files located in the folder **Sample\GUI\_X**. Details about this can be found in the chapter *Configuration* on page 100.

### Executable too large

Some linkers are not able to link only the modules/functions referenced by the project. This results in an executable with a lot of unused code. In this case the use of a library would be very helpful. For details about how to build an emWin library, refer to the chapter *Getting Started* on page 84.

## 14.2 Problems with hardware/driver

If your tools are working fine but your display does not work may one of the following helps to find the problem.

### **Stack size to low?**

Make sure that there have been configured enough stack. Unfortunately we can not estimate exactly how much stack will be used by your configuration and with your compiler. Further the required stack size depends a lot on the application.

### **Initialization of the display wrong?**

Please check if the controller initialization has been adapted to your needs.

### **Display interface configured wrong?**

When starting to work with emWin and the display does not show something you should use an oscilloscope to measure the pins connected with the display/controller. If there is a problem, check the following:

- If using a simple bus interface: Probably the hardware routines have not been configured correctly. If possible use an emulator and step through these routines.
- If using a full bus interface: Probably the register/memory access have not been configured correctly.

## 14.3 Problems with API functions

If your tool chain and your hardware works fine but the API functions do not function as documented, make a small example as described in *Contacting support* on page 3162. This allows us to easily reproduce the problem and solve it quickly.

## 14.4 Problems with the performance

If there is any performance problem with emWin it should be determined, which part of the software causes the problem.

### Does the driver cause the problem?

To determine the cause of the problem the first step should be writing a small test routine which executes some test code and measures the time used to execute this code. Starting point should be the file `ProblemReport.c` described above. To measure the time used by the real hardware driver the shipment of emWin contains the driver `GUIDRV_NULL`. This driver can be used if no output to the hardware should be done. Selecting `GUIDRV_NULL` can be achieved by the same way as setting up a real driver:

```
GUI_DEVICE_CreateAndLink(GUIDRV_LIN_16, GUICC_565, 0, 0);
```

The difference between the used time by the real driver and `GUIDRV_NULL` shows the execution time spent in the real hardware driver.

### Driver not optimized?

If there is a significant difference between the use of the real driver and `GUIDRV_NULL` the cause of the problem could be a not optimized driver mode. If working with a driver which does not use the default orientation (nothing mirrored, nothing swapped) the driver may not be optimized for the configured mode. In this case, please contact our support, we should be able to optimize the code.

### Comparable results

To be able to measure the hardware performance for having a comparable result, emWin comes with 2 samples (located in the folder **Sample\Tutorial**) which could be used for measuring the hardware performance. The first one is `BASIC_DriverPerformance.c`. It measures the time required for different kinds of drawing operations which should be supported by each driver. The second one is `BASIC_Performance.c`. It calculates prime numbers and prints the result of reached loops/second. This sample could be used to check the basic configuration of the CPU.

## 14.5 Contacting support

If you need to contact the emWin support, send the following information to the support:

- A detailed description of the problem may written as comment in the example code.
- The configuration files `GUIConf.c`, `GUIConf.h`, `LCDConf.c`, `LCDConf.h`.
- An example source file which can be compiled in the simulation without any additional files as described in the following.
- If there are any problems with the tool chain, also send the error message of the compiler/linker.
- If there are any problems with the hardware/driver and a simple bus interface is used, also send the hardware routines including the configuration.

### Problem report

The following file can be used as a starting point when creating a problem report. Also fill in the CPU, the used tool chain and the problem description. It can be found under **Sample\Tutorial\ProblemReport.c**:

```

/*****
 *          SEGGER Microcontroller GmbH & Co. KG          *
 *      Solutions for real time microcontroller applications *
 *
 *          emWin problem report                          *
 *
 *****/
-----
File           : ProblemReport.c
CPU            :
Compiler/Tool chain :
Problem description :
-----
*/
#include "GUI.h"
/* Add further GUI header files here as required. */
/*****
 *
 *      Static code
 *
 *****/
* Please insert helper functions here if required.
*/
/*****
 *
 *      MainTask
 *
*/
void MainTask(void) {
    GUI_Init();
    /*
     * To do: Insert the code here which demonstrates the problem.
     */
    while (1); /* Make sure program does not terminate */
}

```

## 14.6 FAQ

Q: *I use a different LCD controller. Can I still use emWin?*

A: Yes. The hardware access is done in the driver module and is completely independent of the rest of the GUI. The appropriate driver can be easily written for any controller (memory-mapped or bus-driven). Please get in touch with us.

Q: *Which CPUs can I use emWin with?*

A: emWin can be used with any CPU (or MPU) for which a C compiler exists. Of course, it will work faster on 16/32-bit CPUs than on 8-bit CPUs.

Q: *Is emWin flexible enough to do what I want to do in my application?*

A: emWin should be flexible enough for any application. If for some reason you do not think it is in your case, please contact us. Believe it or not, the source code is available.

Q: *Does emWin work in a multitask environment?*

A: Yes, it has been designed with multitask kernels in mind.

Q: *Can I update my emWin application to the latest version without any problems?*

A: Yes, since emWin is kept backward compatible. For example, macros are added when a function name has been changed. However, if any migration issues appear when updating to a newer version, please contact us and let us know.

# Chapter 15

## Indexes

---



## 15.1 Function index

BUTTON\_Callback, 987  
 BUTTON\_Create, **1007**  
 BUTTON\_CreateAsChild, **1008**  
 BUTTON\_CreateEx, **1009**  
 BUTTON\_CreateIndirect, 810, 810, **1010**, 2453, 2453, 2872  
 BUTTON\_CreateUser, **1011**  
 BUTTON\_GetBitmap, **1012**  
 BUTTON\_GetBkColor, **1013**  
 BUTTON\_GetDefaultBkColor, **1014**  
 BUTTON\_GetDefaultFont, **1015**  
 BUTTON\_GetDefaultTextAlign, **1016**  
 BUTTON\_GetDefaultTextColor, **1017**  
 BUTTON\_GetFont, **1018**  
 BUTTON\_GetSkinFlexProps, 2512  
 BUTTON\_GetText, **1019**  
 BUTTON\_GetTextAlign, **1020**  
 BUTTON\_GetTextColor, **1021**  
 BUTTON\_GetUserData, **1022**  
 BUTTON\_IsPressed, **1023**  
 BUTTON\_SetBitmap, **1024**  
 BUTTON\_SetBitmapEx, **1025**  
 BUTTON\_SetBkColor, **1026**  
 BUTTON\_SetBMP, **1027**  
 BUTTON\_SetBMPEX, **1028**  
 BUTTON\_SetDefaultBkColor, **1029**  
 BUTTON\_SetDefaultFocusColor, **1030**  
 BUTTON\_SetDefaultFont, **1031**  
 BUTTON\_SetDefaultSkin, 2512  
 BUTTON\_SetDefaultTextAlign, **1032**  
 BUTTON\_SetDefaultTextColor, **1033**  
 BUTTON\_SetFocusColor, **1034**  
 BUTTON\_SetFont, **1036**  
 BUTTON\_SetFrameColor, **1037**  
 BUTTON\_SetPressed, **1038**  
 BUTTON\_SetReactOnLevel, **1039**  
 BUTTON\_SetReactOnTouch, **1040**  
 BUTTON\_SetSkin, 2512  
 BUTTON\_SetSkinFlexProps, 2512, **2526**  
 BUTTON\_SetStreamedBitmap, **1041**, 1041  
 BUTTON\_SetStreamedBitmapEx, **1042**  
 BUTTON\_SetText, **1043**, 2873  
 BUTTON\_SetTextAlign, **1044**  
 BUTTON\_SetTextColor, **1045**  
 BUTTON\_SetTextOffset, **1046**  
 BUTTON\_SetToggleMode, **1047**  
 BUTTON\_SetUserData, **1048**  
 BUTTON\_Toggle, **1049**  
 CALENDAR\_AddKey, **2463**  
 CALENDAR\_Create, **2464**  
 CALENDAR\_GetDate, **2465**  
 CALENDAR\_GetDaysOfMonth, **2466**  
 CALENDAR\_GetSel, **2467**  
 CALENDAR\_GetWeekday, **2468**  
 CALENDAR\_SetDate, **2469**  
 CALENDAR\_SetDefaultBkColor, **2471**  
 CALENDAR\_SetDefaultColor, **2472**  
 CALENDAR\_SetDefaultDays, **2473**  
 CALENDAR\_SetDefaultFont, **2474**  
 CALENDAR\_SetDefaultMonths, **2475**  
 CALENDAR\_SetDefaultSize, **2476**  
 CALENDAR\_SetSel, **2470**  
 CALENDAR\_ShowDate, **2477**  
 CHECKBOX\_Create, **1058**  
 CHECKBOX\_CreateEx, **1059**  
 CHECKBOX\_CreateIndirect, 2453, 2453  
 CHECKBOX\_GetBkColor, **1062**  
 CHECKBOX\_GetBoxBkColor, **1063**  
 CHECKBOX\_GetDefaultAlign, **1064**  
 CHECKBOX\_GetDefaultBkColor, **1065**  
 CHECKBOX\_GetDefaultFont, **1066**  
 CHECKBOX\_GetDefaultSpacing, **1067**  
 CHECKBOX\_GetDefaultTextColor, **1069**  
 CHECKBOX\_GetFocusColor, **1070**  
 CHECKBOX\_GetFont, **1071**

CHECKBOX\_GetImage, **1072**  
 CHECKBOX\_GetSkinFlexButtonSize, **2531**  
 CHECKBOX\_GetState, **1073**  
 CHECKBOX\_GetText, **1074**  
 CHECKBOX\_GetTextAlign, **1075**  
 CHECKBOX\_GetTextColor, **1076**  
 CHECKBOX\_IsChecked, **1078**  
 CHECKBOX\_SetBkColor, **1079**  
 CHECKBOX\_SetBoxBkColor, **1080**  
 CHECKBOX\_SetDefaultAlign, **1081**  
 CHECKBOX\_SetDefaultBkColor, **1082**  
 CHECKBOX\_SetDefaultFocusColor, **1083**  
 CHECKBOX\_SetDefaultFont, **1084**  
 CHECKBOX\_SetDefaultImage, **1085**  
 CHECKBOX\_SetDefaultSpacing, **1086**  
 CHECKBOX\_SetDefaultTextColor, **1088**  
 CHECKBOX\_SetFocusColor, **1089**  
 CHECKBOX\_SetFont, **1090**  
 CHECKBOX\_SetImage, **1091**  
 CHECKBOX\_SetNumStates, **1092**  
 CHECKBOX\_SetSkinFlexButtonSize, **2532**  
 CHECKBOX\_SetSkinFlexProps, **2533**  
 CHECKBOX\_SetSpacing, **1093**  
 CHECKBOX\_SetState, **1094**  
 CHECKBOX\_SetText, **1095**  
 CHECKBOX\_SetTextAlign, **1096**  
 CHECKBOX\_SetTextColor, **1097**  
 CHOOSECOLOR\_Create, **2484**  
 CHOOSECOLOR\_GetSel, **2485**  
 CHOOSECOLOR\_SetDefaultBorder, **2489**  
 CHOOSECOLOR\_SetDefaultButtonSize, **2490**  
 CHOOSECOLOR\_SetDefaultColor, **2487**  
 CHOOSECOLOR\_SetDefaultSpace, **2488**  
 CHOOSECOLOR\_SetSel, **2486**  
 CHOOSEFILE\_Create, **2494**  
 CHOOSEFILE\_EnableToolTips, **2497**  
 CHOOSEFILE\_SetButtonText, **2498**  
 CHOOSEFILE\_SetDefaultButtonText, **2499**  
 CHOOSEFILE\_SetDelim, **2500**  
 CHOOSEFILE\_SetToolTips, **2501**  
 CHOOSEFILE\_SetTopMode, **2502**  
 Draw, **2624, 2625, 2683, 2684**  
 DROPDOWN\_AddString, **1107**  
 DROPDOWN\_Callback, **987**  
 DROPDOWN\_Clear, **1108**  
 DROPDOWN\_Collapse, **1109**  
 DROPDOWN\_Create, **1110**  
 DROPDOWN\_CreateEx, **1111**  
 DROPDOWN\_CreateIndirect, **1112**  
 DROPDOWN\_CreateUser, **1113**  
 DROPDOWN\_DecSel, **1114**  
 DROPDOWN\_DecSelExp, **1115**  
 DROPDOWN\_DeleteItem, **1116**  
 DROPDOWN\_EnableMotion, **1117**  
 DROPDOWN\_Expand, **1118**  
 DROPDOWN\_GetBkColor, **1119**  
 DROPDOWN\_GetColor, **1120**  
 DROPDOWN\_GetDefaultFont, **1121**  
 DROPDOWN\_GetFont, **1122**  
 DROPDOWN\_GetItemDisabled, **1123**  
 DROPDOWN\_GetItemText, **1124**  
 DROPDOWN\_GetListbox, **1125**  
 DROPDOWN\_GetNumItems, **1126**  
 DROPDOWN\_GetSel, **1127**  
 DROPDOWN\_GetSelExp, **1128**  
 DROPDOWN\_GetTextColor, **1129**  
 DROPDOWN\_GetUserData, **1130**  
 DROPDOWN\_IncSel, **1131**  
 DROPDOWN\_IncSelExp, **1132**  
 DROPDOWN\_InsertString, **1133**  
 DROPDOWN\_SetAutoScroll, **1134**  
 DROPDOWN\_SetBkColor, **1135**  
 DROPDOWN\_SetColor, **1136**  
 DROPDOWN\_SetDefaultColor, **1137**  
 DROPDOWN\_SetDefaultFont, **1138**  
 DROPDOWN\_SetDefaultScrollbarColor, **1139**

DROPDOWN\_SetFont, **1140**  
 DROPDOWN\_SetItemDisabled, **1141**  
 DROPDOWN\_SetItemSpacing, **1142**  
 DROPDOWN\_SetListHeight, **1143**  
 DROPDOWN\_SetScrollbarColor, **1144**  
 DROPDOWN\_SetScrollbarWidth, **1145**  
 DROPDOWN\_SetSel, **1146**  
 DROPDOWN\_SetSelExp, **1147**  
 DROPDOWN\_SetSkinFlexProps, **2538**  
 DROPDOWN\_SetText, **1148**  
 DROPDOWN\_SetTextAlign, **1149**  
 DROPDOWN\_SetTextColor, **1150**  
 DROPDOWN\_SetTextHeight, **1151**  
 DROPDOWN\_SetUpMode, **1152**  
 DROPDOWN\_SetUserData, **1153**  
 EDIT\_AddKey, **1162**  
 EDIT\_Create, **1163**  
 EDIT\_CreateAsChild, **1164**  
 EDIT\_CreateEx, **1165**  
 EDIT\_CreateIndirect, **1166**, 2453, 2453, 2453, 2453  
 EDIT\_CreateUser, **1167**  
 EDIT\_EnableAutoScroll, **1168**  
 EDIT\_EnableBlink, **1169**  
 EDIT\_EnableInversion, **1170**  
 EDIT\_GetBkColor, **1171**  
 EDIT\_GetBorderSize, **1172**  
 EDIT\_GetCharAtPixel, **1173**  
 EDIT\_GetCursorCharPos, **1174**  
 EDIT\_GetCursorPixelPos, **1175**  
 EDIT\_GetDefaultBkColor, **1176**  
 EDIT\_GetDefaultFont, **1177**  
 EDIT\_GetDefaultTextAlign, **1178**  
 EDIT\_GetDefaultTextColor, **1179**  
 EDIT\_GetFloatValue, **1180**  
 EDIT\_GetFont, **1181**  
 EDIT\_GetMinMax, **1182**  
 EDIT\_GetNumChars, **1183**  
 EDIT\_GetSel, **1184**  
 EDIT\_GetSelText, **1185**  
 EDIT\_GetText, **1186**  
 EDIT\_GetTextAlign, **1187**  
 EDIT\_GetTextColor, **1188**  
 EDIT\_GetUserData, **1189**  
 EDIT\_GetValue, **1190**  
 EDIT\_SetBinMode, **1191**, 2454, 2455  
 EDIT\_SetBkColor, **1192**  
 EDIT\_SetCursorAtChar, **1193**  
 EDIT\_SetCursorAtPixel, **1194**  
 EDIT\_SetDecMode, **1195**  
 EDIT\_SetDefaultBkColor, **1196**  
 EDIT\_SetDefaultFont, **1197**  
 EDIT\_SetDefaultTextAlign, **1198**  
 EDIT\_SetDefaultTextColor, **1199**  
 EDIT\_SetFloatMode, **1200**  
 EDIT\_SetFloatValue, **1201**  
 EDIT\_SetFont, **1203**  
 EDIT\_SetHexMode, **1204**, 2454, 2455  
 EDIT\_SetInsertMode, **1205**  
 EDIT\_SetMaxLen, **1206**  
 EDIT\_SetpfAddKeyEx, **1207**  
 EDIT\_SetSel, **1208**, 1208, 1208, 1208  
 EDIT\_SetText, **1209**, 2454, 2454, 2455, 2455  
 EDIT\_SetTextAlign, **1210**, 2454, 2455  
 EDIT\_SetTextColor, **1211**  
 EDIT\_SetTextMode, **1212**  
 EDIT\_SetUlongMode, **1214**  
 EDIT\_SetUserData, **1215**  
 EDIT\_SetValue, **1213**  
 FRAMEWIN\_AddButton, **1224**  
 FRAMEWIN\_AddCloseButton, **1225**  
 FRAMEWIN\_AddMaxButton, **1226**  
 FRAMEWIN\_AddMenu, **1227**  
 FRAMEWIN\_AddMinButton, **1228**  
 FRAMEWIN\_Create, **1229**  
 FRAMEWIN\_CreateAsChild, **1230**  
 FRAMEWIN\_CreateEx, **1231**

FRAMEWIN\_CreateIndirect, 810, **1232**, 2453, 2872  
 FRAMEWIN\_CreateUser, **1233**  
 FRAMEWIN\_DrawSkinFlex, 2514, 2514  
 FRAMEWIN\_GetActive, **1234**  
 FRAMEWIN\_GetBarColor, **1235**  
 FRAMEWIN\_GetBorderSize, **1236**  
 FRAMEWIN\_GetDefaultBarColor, **1237**  
 FRAMEWIN\_GetDefaultBorderSize, **1238**  
 FRAMEWIN\_GetDefaultClientColor, **1239**  
 FRAMEWIN\_GetDefaultFont, **1240**  
 FRAMEWIN\_GetDefaultTextColor, **1241**  
 FRAMEWIN\_GetDefaultTitleHeight, **1242**  
 FRAMEWIN\_GetFont, **1243**, 1266  
 FRAMEWIN\_GetText, **1244**, 1266, 2514  
 FRAMEWIN\_GetTextAlign, **1245**, 1266  
 FRAMEWIN\_GetTitleHeight, **1246**  
 FRAMEWIN\_GetUserData, **1247**  
 FRAMEWIN\_IsMaximized, **1249**  
 FRAMEWIN\_IsMinimized, **1248**  
 FRAMEWIN\_Maximize, **1250**  
 FRAMEWIN\_Minimize, **1251**  
 FRAMEWIN\_OwnerDraw, **1252**, 1266  
 FRAMEWIN\_Restore, **1253**  
 FRAMEWIN\_SetActive, **1254**  
 FRAMEWIN\_SetBarColor, **1255**  
 FRAMEWIN\_SetBorderSize, **1256**  
 FRAMEWIN\_SetClientColor, **1257**  
 FRAMEWIN\_SetDefaultBarColor, **1258**  
 FRAMEWIN\_SetDefaultBorderSize, **1259**  
 FRAMEWIN\_SetDefaultClientColor, **1260**  
 FRAMEWIN\_SetDefaultFont, **1261**  
 FRAMEWIN\_SetDefaultTextColor, **1262**  
 FRAMEWIN\_SetDefaultTitleHeight, **1263**  
 FRAMEWIN\_SetFont, **1264**, 2873  
 FRAMEWIN\_SetMoveable, **1265**  
 FRAMEWIN\_SetOwnerDraw, **1266**, 1266  
 FRAMEWIN\_SetResizeable, **1268**  
 FRAMEWIN\_SetSkin, 2514  
 FRAMEWIN\_SetSkinFlexProps, **2542**  
 FRAMEWIN\_SetText, **1269**, 2456, 2456  
 FRAMEWIN\_SetTextAlign, **1270**, 2873  
 FRAMEWIN\_SetTextColor, **1271**  
 FRAMEWIN\_SetTextColorEx, **1272**  
 FRAMEWIN\_SetTitleHeight, **1273**  
 FRAMEWIN\_SetTitleVis, **1274**  
 FRAMEWIN\_SetUserData, **1275**  
 GAUGE\_CreateIndirect, **1282**  
 GAUGE\_CreateUser, **1283**  
 GAUGE\_GetRange, **1285**  
 GAUGE\_GetValue, **1284**  
 GAUGE\_SetAlign, **1286**  
 GAUGE\_SetBkColor, **1287**  
 GAUGE\_SetColor, **1288**  
 GAUGE\_SetOffset, **1289**  
 GAUGE\_SetRadius, **1290**  
 GAUGE\_SetRange, **1291**  
 GAUGE\_SetRoundedEnd, **1292**  
 GAUGE\_SetRoundedValue, **1293**  
 GAUGE\_SetValue, **1294**  
 GAUGE\_SetValueRange, **1295**  
 GAUGE\_SetWidth, **1296**  
 GRAPH\_AttachData, 1299, **1304**  
 GRAPH\_AttachScale, 1299, **1305**  
 GRAPH\_CreateEx, 1299, **1306**, 1326, 1350  
 GRAPH\_CreateIndirect, **1307**  
 GRAPH\_CreateUser, **1308**  
 GRAPH\_DATA\_XY\_AddPoint, **1339**  
 GRAPH\_DATA\_XY\_Clear, **1340**  
 GRAPH\_DATA\_XY\_Create, **1341**, 1350  
 GRAPH\_DATA\_XY\_Delete, **1342**  
 GRAPH\_DATA\_XY\_GetLineVis, **1343**  
 GRAPH\_DATA\_XY\_GetPoint, **1344**  
 GRAPH\_DATA\_XY\_GetPointVis, **1345**  
 GRAPH\_DATA\_XY\_SetColor, **1346**  
 GRAPH\_DATA\_XY\_SetLineStyle, **1347**  
 GRAPH\_DATA\_XY\_SetLineVis, **1348**

GRAPH\_DATA\_XY\_SetOffX, **1349**, 1349  
 GRAPH\_DATA\_XY\_SetOffY, **1349**, 1349  
 GRAPH\_DATA\_XY\_SetOwnerDraw, **1350**, 1350  
 GRAPH\_DATA\_XY\_SetPenSize, **1351**  
 GRAPH\_DATA\_XY\_SetPointVis, **1352**  
 GRAPH\_DATA\_YT\_AddValue, **1330**  
 GRAPH\_DATA\_YT\_Clear, **1331**  
 GRAPH\_DATA\_YT\_Create, 1299, **1332**  
 GRAPH\_DATA\_YT\_Delete, **1333**  
 GRAPH\_DATA\_YT\_GetValue, **1334**  
 GRAPH\_DATA\_YT\_MirrorX, **1335**  
 GRAPH\_DATA\_YT\_SetAlign, **1336**  
 GRAPH\_DATA\_YT\_SetColor, **1337**  
 GRAPH\_DATA\_YT\_SetOffY, **1338**, 1338  
 GRAPH\_DetachData, **1309**  
 GRAPH\_DetachScale, **1310**  
 GRAPH\_GetColor, **1311**  
 GRAPH\_GetScrollValue, **1312**  
 GRAPH\_GetUserData, **1313**  
 GRAPH\_InvertScrollbar, **1314**  
 GRAPH\_SCALE\_Create, 1299, **1353**  
 GRAPH\_SCALE\_Delete, **1354**  
 GRAPH\_SCALE\_SetFactor, **1355**  
 GRAPH\_SCALE\_SetFont, **1356**  
 GRAPH\_SCALE\_SetNumDecs, **1357**  
 GRAPH\_SCALE\_SetOff, **1358**  
 GRAPH\_SCALE\_SetPos, **1359**  
 GRAPH\_SCALE\_SetTextColor, **1360**  
 GRAPH\_SCALE\_SetTickDist, **1361**  
 GRAPH\_SetAutoScrollbar, **1315**  
 GRAPH\_SetBorder, **1316**  
 GRAPH\_SetColor, **1317**  
 GRAPH\_SetGridDistX, **1318**  
 GRAPH\_SetGridDistY, **1318**  
 GRAPH\_SetGridFixedX, **1319**  
 GRAPH\_SetGridOffX, **1320**  
 GRAPH\_SetGridOffY, **1321**  
 GRAPH\_SetGridVis, **1322**  
 GRAPH\_SetLineStyleH, **1323**  
 GRAPH\_SetLineStyleV, **1323**  
 GRAPH\_SetScrollValue, **1324**  
 GRAPH\_SetUserData, **1325**  
 GRAPH\_SetUserDraw, **1326**, 1327  
 GRAPH\_SetVSizeX, **1328**  
 GRAPH\_SetVSizeY, **1328**  
 GUI\_memcpy, 129  
 GUI\_AA\_DisableHiRes, **2594**, 2625  
 GUI\_AA\_DrawArc, **2600**  
 GUI\_AA\_DrawCircle, **2601**  
 GUI\_AA\_DrawLine, 2590, 2590, **2602**, 2620, 2620, 2622  
 GUI\_AA\_DrawPie, **2603**  
 GUI\_AA\_DrawPolyOutline, **2604**, 2604  
 GUI\_AA\_DrawPolyOutlineEx, **2605**  
 GUI\_AA\_DrawRoundedFrame, **2606**  
 GUI\_AA\_DrawRoundedFrameEx, **2607**  
 GUI\_AA\_DrawRoundedRect, **2608**, 2608  
 GUI\_AA\_DrawRoundedRectEx, **2609**  
 GUI\_AA\_EnableGammaAA4, **2617**  
 GUI\_AA\_EnableHiRes, **2595**, 2622, 2625  
 GUI\_AA\_FillCircle, **2610**, 2657  
 GUI\_AA\_FillEllipse, **2611**  
 GUI\_AA\_FillEllipseXL, **2612**  
 GUI\_AA\_FillPolygon, **2613**, 2624, 2624  
 GUI\_AA\_FillRoundedRect, **2614**, 2614  
 GUI\_AA\_FillRoundedRectEx, **2615**  
 GUI\_AA\_GetFactor, **2596**  
 GUI\_AA\_GetGammaAA4, **2618**  
 GUI\_AA\_SetBufferSize, **2598**  
 GUI\_AA\_SetDrawMode, **2616**  
 GUI\_AA\_SetFactor, **2599**, 2620, 2620, 2622, 2625  
 GUI\_AA\_SetFuncDrawArc, **154**  
 GUI\_AA\_SetFuncDrawCircle, **151**  
 GUI\_AA\_SetFuncDrawLine, **152**  
 GUI\_AA\_SetFuncDrawPolyOutline, **153**  
 GUI\_AA\_SetFuncFillCircle, **149**  
 GUI\_AA\_SetFuncFillPolygon, **150**

GUI\_AA\_SetGammaAA4, **2619**  
 GUI\_AA\_SetpfDrawCharAA4, **141**  
 GUI\_AddRect, **284**, 1949  
 GUI\_ALLOC\_AssignMemory, **105**, 106  
 GUI\_ALLOC\_GetMaxUsedBytes, **162**  
 GUI\_ALLOC\_GetMemInfo, **164**  
 GUI\_ALLOC\_GetNumFreeBytes, **163**  
 GUI\_ALLOC\_GetNumUsedBytes, **165**  
 GUI\_AlphaEnableFillRectHW, **136**  
 GUI\_ANIM\_AddItem, 614, 616, **620**  
 GUI\_ANIM\_AddItemById, **621**  
 GUI\_ANIM\_Create, 614, 617, 618, **622**  
 GUI\_ANIM\_CreateWithId, **623**  
 GUI\_ANIM\_Delete, **624**  
 GUI\_ANIM\_DeleteAll, **625**  
 GUI\_ANIM\_DeleteById, **626**  
 GUI\_ANIM\_Exec, **627**, 627  
 GUI\_ANIM\_Get, **628**  
 GUI\_ANIM\_GetData, **629**  
 GUI\_ANIM\_GetFirst, **630**  
 GUI\_ANIM\_GetItemData, **631**  
 GUI\_ANIM\_GetNext, **632**  
 GUI\_ANIM\_GetNumItems, **633**  
 GUI\_ANIM\_IsRunning, **634**  
 GUI\_ANIM\_Start, **635**  
 GUI\_ANIM\_StartEx, 617, 618, **636**  
 GUI\_ANIM\_StartExId, **637**  
 GUI\_ANIM\_Stop, **638**  
 GUI\_ANIM\_StopById, **639**  
 GUI\_AssignCursorLayer, **2914**  
 GUI\_BARCODE\_Draw, **373**, 373, 373  
 GUI\_BARCODE\_GetXSize, **375**  
 GUI\_BDF\_CreateFont, **551**  
 GUI\_BDF\_DeleteFont, **552**  
 GUI\_BDF\_EmboldenFont, **553**  
 GUI\_BDF\_EmboldenFontEx, **554**  
 GUI\_BDF\_GetFamilyName, **555**  
 GUI\_BDF\_GetStyleName, **556**  
 GUI\_BDF\_SetLetterSpacing, **557**  
 GUI\_BMP\_Draw, **427**  
 GUI\_BMP\_DrawEx, **428**  
 GUI\_BMP\_DrawScaled, **429**  
 GUI\_BMP\_DrawScaledEx, **430**  
 GUI\_BMP\_EnableAlpha, **431**  
 GUI\_BMP\_GetXSize, **432**  
 GUI\_BMP\_GetXSizeEx, **433**  
 GUI\_BMP\_GetYSize, **434**  
 GUI\_BMP\_GetYSizeEx, **435**  
 GUI\_BMP\_Serialize, **436**, 436  
 GUI\_BMP\_SerializeEx, **437**  
 GUI\_BMP\_SerializeExBpp, **438**  
 GUI\_CalcColorDist, **519**  
 GUI\_CalcVisColorError, **520**  
 GUI\_Clear, 209, 219, 265, 266, 291, **293**, 293, 321, 324, 357, 359, 361, 368, 483, 649, 802, 811, 811, 836,  
 844, 895, 901, 918, 918, 980, 980, 981, 2608, 2614, 2620, 2622, 2637, 2638, 2657, 2657, 2658, 2663,  
 2674, 2901, 2901, 2905, 2906  
 GUI\_ClearKeyBuffer, **733**  
 GUI\_ClearRect, **294**, 2624, 2624  
 GUI\_Color2Index, **521**  
 GUI\_Color2VisColor, **522**  
 GUI\_ColorIsAvailable, **523**  
 GUI\_CopyRect, **295**  
 GUI\_CreateBitmapFromStream, **333**, 333  
 GUI\_CreateDialogBox, 810, **2457**, 2874  
 GUI\_CURSOR\_GetState, **2779**  
 GUI\_CURSOR\_Hide, **2780**  
 GUI\_CURSOR\_Select, **2781**  
 GUI\_CURSOR\_SelectAnim, **2782**  
 GUI\_CURSOR\_SetPosition, **2783**  
 GUI\_CURSOR\_Show, **2784**  
 GUI\_DCACHE\_Clear, **159**  
 GUI\_DCACHE\_SetClearCacheHook, **160**  
 GUI\_Delay, 224, 293, 306, 362, 368, 617, 650, 741, **782**, 811, 811, 845, 901, 980, 981, 981, 981, 2621,  
 2622, 2625, 2638, 2658, 2717, 2875, 2901, 2903  
 GUI\_DEVICE\_Create, 2965, 2969, 2969, 2970, 2970

GUI\_DEVICE\_CreateAndLink, 113, **116**, 501, 714, 714, 2907, 2907, 2909, 2909, 2911, 2936, 2961, 2964, 2965, 2965, 2969, 2970, 2971, 2973, 2991, 2995, 2997, 2999, 3003, 3007, 3007, 3014, 3017, 3019, 3023, 3025, 3034, 3036, 3044, 3047, 3061, 3062, 3065, 3066, 3069, 3071, 3077, 3081, 3082, 3084, 3087, 3090, 3093, 3096, 3161  
 GUI\_DIRTYDEVICE\_Create, **392**  
 GUI\_DIRTYDEVICE\_CreateEx, **393**  
 GUI\_DIRTYDEVICE\_Delete, **394**  
 GUI\_DIRTYDEVICE\_DeleteEx, **395**  
 GUI\_DIRTYDEVICE\_Fetch, **396**  
 GUI\_DIRTYDEVICE\_FetchEx, **397**  
 GUI\_DispBin, **272**, 272  
 GUI\_DispBinAt, **273**, 273  
 GUI\_DispCEOL, **224**, 224  
 GUI\_DispChar, **225**, 225, 750, 750, 918, 918  
 GUI\_DispCharAt, **226**, 226  
 GUI\_DispChars, **227**, 227  
 GUI\_DispDec, **259**, 259, 259, 582, 2689, 2689, 2689, 2689  
 GUI\_DispDecAt, 99, 247, **260**  
 GUI\_DispDecMin, **261**, 261, 918, 918  
 GUI\_DispDecShift, **262**  
 GUI\_DispDecSpace, **263**, 263  
 GUI\_DispFloat, **266**, 266, 266  
 GUI\_DispFloatFix, 266, 266, **268**  
 GUI\_DispFloatMin, 266, 266, **269**  
 GUI\_DispHex, **274**, 274  
 GUI\_DispHexAt, **275**, 275  
 GUI\_DispNextLine, **248**, 741  
 GUI\_DispSDec, **264**  
 GUI\_DispSDecShift, **265**, 265  
 GUI\_DispSFloatFix, 266, 266, **270**  
 GUI\_DispSFloatMin, 266, 266, **271**  
 GUI\_DispString, 99, 99, 218, **228**, 228, 228, 249, 259, 259, 261, 263, 276, 537, 540, 540, 579, 582, 740, 740, 741, 811, 811, 980, 2535, 2622, 2622, 2622, 2622, 2622, 2641, 2674, 2689, 2689, 2689, 2689  
 GUI\_DispStringAt, 210, 224, 224, **229**, 229, 265, 266, 266, 266, 266, 266, 293, 361, 361, 582, 582, 582, 802, 980, 985, 2622, 2674, 2789, 2789, 2789  
 GUI\_DispStringAtCEOL, **230**  
 GUI\_DispStringHCenterAt, 219, 219, 219, 219, 220, **231**, 321, 324, 325, 368, 2620, 2620, 2620, 2625, 2625, 2901, 2901, 2905  
 GUI\_DispStringInRect, **232**, 232, 1266, 2514, 2663  
 GUI\_DispStringInRectEx, **233**, 233, 2658  
 GUI\_DispStringInRectWrap, **234**, 234  
 GUI\_DispStringInRectWrapEx, **235**  
 GUI\_DispStringLen, **236**  
 GUI\_DrawArc, **368**, 368  
 GUI\_DrawArcHR, **370**  
 GUI\_DrawArcHREx, **371**  
 GUI\_DrawBitmap, 325, **327**, 327, 333, 1454, 2514  
 GUI\_DrawBitmapEx, **328**  
 GUI\_DrawBitmapMag, **329**  
 GUI\_DrawCircle, **363**, 363  
 GUI\_DrawEllipse, **365**, 367  
 GUI\_DrawEllipseXL, **366**  
 GUI\_DrawFrame, **296**  
 GUI\_DrawFrameEx, **297**  
 GUI\_DrawGradientH, **298**, 298, 1266, 2638  
 GUI\_DrawGradientHEX, **299**  
 GUI\_DrawGradientMH, **306**, 306  
 GUI\_DrawGradientMHEX, **307**  
 GUI\_DrawGradientMV, **306**  
 GUI\_DrawGradientMVEx, **307**  
 GUI\_DrawGradientRoundedH, **302**, 302  
 GUI\_DrawGradientRoundedHEX, **303**  
 GUI\_DrawGradientRoundedV, **304**, 304  
 GUI\_DrawGradientRoundedVEx, **305**  
 GUI\_DrawGradientV, **300**, 300, 2637, 2657, 2663  
 GUI\_DrawGradientVEx, **301**  
 GUI\_DrawGraph, **372**, 372  
 GUI\_DrawHLine, 325, **346**, 2409, 2409, 2906  
 GUI\_DrawLine, 219, 219, **347**, 436, 2620, 2629, 2637, 2637, 2658, 2689  
 GUI\_DrawLineRel, **348**  
 GUI\_DrawLineTo, **349**  
 GUI\_DrawPie, **382**, 382  
 GUI\_DrawPieHR, **383**  
 GUI\_DrawPixel, **308**  
 GUI\_DrawPoint, **309**, 368, 2717  
 GUI\_DrawPolygon, **356**

GUI\_DrawPolyLine, **350**  
 GUI\_DrawRect, **310**, 1350, 2663  
 GUI\_DrawRectEx, **311**  
 GUI\_DrawRoundedFrame, **312**  
 GUI\_DrawRoundedFrameEx, **313**  
 GUI\_DrawRoundedRect, **314**  
 GUI\_DrawRoundedRectEx, **315**  
 GUI\_DrawStreamedBitmap, **337**  
 GUI\_DrawStreamedBitmapAuto, **338**  
 GUI\_DrawStreamedBitmapEx, **339**  
 GUI\_DrawStreamedBitmapExAuto, **340**  
 GUI\_DrawVLine, **351**  
 GUI\_EnableAlpha, 321, 321, **322**, 324  
 GUI\_EndDialog, 2455, 2455, 2456, 2456, **2460**  
 GUI\_EnlargePolygon, **357**, 357  
 GUI\_ErrorOut, **789**  
 GUI\_Exec, **783**, 944, 2878, 2882, 2887  
 GUI\_Exec1, **784**  
 GUI\_ExecCreatedDialog, **2458**  
 GUI\_ExecDialogBox, 2453, **2459**  
 GUI\_Exit, **97**  
 GUI\_FillCircle, 291, 291, 325, **364**, 364, 2905, 2906  
 GUI\_FillEllipse, **367**, 367, 367  
 GUI\_FillPolygon, 357, 357, **358**, 359, 361  
 GUI\_FillRect, **316**, 321, 321, 321, 321, 324, 324, 324, 2789, 2789, 2789, 2901, 2905, 2905, 2905, 2905, 2905  
 GUI\_FillRectEx, 233, 234, **317**  
 GUI\_FillRoundedRect, **318**  
 GUI\_FillRoundedRectEx, **319**  
 GUI\_FT\_DestroyCache, **558**  
 GUI\_FT\_Done, **559**  
 GUI\_FT\_GetMeasurementChars, **560**  
 GUI\_FT\_SetCacheSize, **561**  
 GUI\_FT\_SetMeasurementChars, **562**  
 GUI\_GCACHE\_4\_Create, **407**  
 GUI\_GCACHE\_4\_CreateEx, **408**  
 GUI\_GetBkColor, **507**  
 GUI\_GetBkColorIndex, **508**  
 GUI\_GetCharDistX, **563**  
 GUI\_GetCharFromPos, **237**  
 GUI\_GetClientRect, 232, **285**  
 GUI\_GetClipRect, **286**  
 GUI\_GetColor, **509**  
 GUI\_GetColorIndex, **510**  
 GUI\_GetDefaultBkColor, **512**  
 GUI\_GetDefaultColor, **511**  
 GUI\_GetDefaultFont, **564**  
 GUI\_GetDispPosX, **250**  
 GUI\_GetDispPosY, **251**  
 GUI\_GetDrawMode, **287**  
 GUI\_GetFallbackFont, **565**  
 GUI\_GetFont, **566**  
 GUI\_GetFontDistY, **567**  
 GUI\_GetFontInfo, **568**, 568  
 GUI\_GetFontSizeY, **569**  
 GUI\_GetKey, **734**  
 GUI\_GetKeyState, **735**  
 GUI\_GetLayerPosEx, **2915**  
 GUI\_GetLeadingBlankCols, **570**  
 GUI\_GetLeadingBlankRows, **571**  
 GUI\_GetLineStyle, **352**  
 GUI\_GetOrg, **2793**  
 GUI\_GetPenSize, **288**  
 GUI\_GetPixelIndex, **289**  
 GUI\_GetShowMissingCharacters, **238**  
 GUI\_GetStreamedBitmapInfo, **342**  
 GUI\_GetStreamedBitmapInfoEx, **343**  
 GUI\_GetStringDistX, **572**  
 GUI\_GetStringDistXEx, **573**  
 GUI\_GetTextAlign, **245**  
 GUI\_GetTextExtend, **574**  
 GUI\_GetTextMode, **241**  
 GUI\_GetTime, **785**  
 GUI\_GetTimeSlice, **786**  
 GUI\_GetTrailingBlankCols, **575**  
 GUI\_GetTrailingBlankRows, **576**  
 GUI\_GetVersionString, **276**, 276



GUI\_GetYDistOfFont, **577**  
 GUI\_GetYSizeOfFont, **578**  
 GUI\_GIF\_Draw, **451**  
 GUI\_GIF\_DrawEx, **452**  
 GUI\_GIF\_DrawSub, **453**  
 GUI\_GIF\_DrawSubEx, **454**  
 GUI\_GIF\_DrawSubScaled, **455**  
 GUI\_GIF\_DrawSubScaledEx, **456**  
 GUI\_GIF\_GetComment, **457**  
 GUI\_GIF\_GetCommentEx, **458**  
 GUI\_GIF\_GetImageInfo, **459**  
 GUI\_GIF\_GetImageInfoEx, **460**  
 GUI\_GIF\_GetInfo, **461**  
 GUI\_GIF\_GetInfoEx, **462**  
 GUI\_GIF\_GetXSize, **463**  
 GUI\_GIF\_GetXSizeEx, **464**  
 GUI\_GIF\_GetYSize, **465**  
 GUI\_GIF\_GetYSizeEx, **466**  
 GUI\_GotoX, **249**, 266, 266, 266, 266, 266  
 GUI\_GotoXY, **249**, 249, 918, 918  
 GUI\_GotoY, **249**  
 GUI\_Index2Color, **524**  
 GUI\_Init, **95**, 99, 99, 209, 265, 306, 327, 362, 372, 436, 439, 649, 741, 811, 844, 901, 981, 1350, 1398, 2608, 2614, 2621, 2622, 2625, 2637, 2657, 2674, 2689, 2692, 2716, 2717, 2740, 2874, 2878, 2901, 3162  
 GUI\_InvertRect, **320**  
 GUI\_IsInFont, **579**, 579  
 GUI\_IsInitialized, **96**  
 GUI\_JPEG\_Draw, 439, **442**, 2650  
 GUI\_JPEG\_DrawEx, **443**  
 GUI\_JPEG\_DrawScaled, **444**  
 GUI\_JPEG\_DrawScaledEx, **445**  
 GUI\_JPEG\_GetInfo, **446**  
 GUI\_JPEG\_GetInfoEx, **447**  
 GUI\_JPEG\_SetpfDrawEx, **156**  
 GUI\_LANG\_Clear, **762**  
 GUI\_LANG\_GetLang, **763**  
 GUI\_LANG\_GetNumItems, **764**  
 GUI\_LANG\_GetText, **765**  
 GUI\_LANG\_GetTextBuffered, **766**  
 GUI\_LANG\_GetTextBufferedEx, **767**  
 GUI\_LANG\_GetTextEx, **768**  
 GUI\_LANG\_GetTextLen, **769**  
 GUI\_LANG\_GetTextLenEx, **770**  
 GUI\_LANG\_LoadCSV, **760**  
 GUI\_LANG\_LoadCSVEx, **761**  
 GUI\_LANG\_LoadText, **758**  
 GUI\_LANG\_LoadTextEx, **759**  
 GUI\_LANG\_SetLang, **771**  
 GUI\_LANG\_SetMaxNumLang, **772**  
 GUI\_LANG\_SetSep, **773**  
 GUI\_Log, **790**  
 GUI\_MagnifyPolygon, **359**, 359  
 GUI\_MEASDEV\_ClearRect, **2685**  
 GUI\_MEASDEV\_Create, **2686**, 2689  
 GUI\_MEASDEV\_Delete, **2687**, 2689  
 GUI\_MEASDEV\_GetRect, **2688**, 2689  
 GUI\_MEASDEV\_Select, **2689**, 2689  
 GUI\_MEMDEV\_BlendColor32, **2699**  
 GUI\_MEMDEV\_BlendWinBk, **2707**  
 GUI\_MEMDEV\_BlurAndBlendWinBk, **2708**  
 GUI\_MEMDEV\_BlurWinBk, **2709**  
 GUI\_MEMDEV\_Clear, **2636**  
 GUI\_MEMDEV\_ClearAlpha, **2637**, 2638  
 GUI\_MEMDEV\_CopyFromLCD, **2639**  
 GUI\_MEMDEV\_CopyToLCD, 2629, **2640**, 2674  
 GUI\_MEMDEV\_CopyToLCDAA, **2641**, 2641  
 GUI\_MEMDEV\_CopyToLCDAt, **2642**, 2650, 2650, 2650, 2663, 2663  
 GUI\_MEMDEV\_Create, 2629, 2641, **2643**, 2674, 2674  
 GUI\_MEMDEV\_CreateAuto, 2625, **2681**, 2684  
 GUI\_MEMDEV\_CreateBlurredDevice32, **2700**  
 GUI\_MEMDEV\_CreateBlurredDevice32HQ, **2702**  
 GUI\_MEMDEV\_CreateBlurredDevice32LQ, **2703**  
 GUI\_MEMDEV\_CreateCopy, **2644**  
 GUI\_MEMDEV\_CreateEx, **2645**  
 GUI\_MEMDEV\_CreateFixed, 2637, 2638, **2646**, 2646, 2650, 2650, 2650, 2657, 2663, 2663  
 GUI\_MEMDEV\_CreateFixed32, **2647**, 2658

GUI\_MEMDEV\_Delete, **2648**  
 GUI\_MEMDEV\_DeleteAuto, **2682**, 2684  
 GUI\_MEMDEV\_Dither32, **2704**  
 GUI\_MEMDEV\_Draw, **2679**  
 GUI\_MEMDEV\_DrawAuto, 2625, 2625, **2683**, 2684  
 GUI\_MEMDEV\_DrawPerspectiveX, **2649**, 2650, 2650  
 GUI\_MEMDEV\_FadeInDevices, **2690**  
 GUI\_MEMDEV\_FadeInWindow, **2694**  
 GUI\_MEMDEV\_FadeOutDevices, **2691**  
 GUI\_MEMDEV\_FadeOutWindow, **2694**  
 GUI\_MEMDEV\_GetBitsPerPixel, **2651**  
 GUI\_MEMDEV\_GetDataPtr, **2652**  
 GUI\_MEMDEV\_GetSelMemdev, **2653**  
 GUI\_MEMDEV\_GetXSize, **2654**  
 GUI\_MEMDEV\_GetYSize, **2655**  
 GUI\_MEMDEV\_MarkDirty, **2656**  
 GUI\_MEMDEV\_MoveInWindow, **2695**  
 GUI\_MEMDEV\_MoveOutWindow, **2695**  
 GUI\_MEMDEV\_MULTIBUF\_Enable, **2710**  
 GUI\_MEMDEV\_PunchOutDevice, **2657**, 2658  
 GUI\_MEMDEV\_ReduceYSize, **2659**  
 GUI\_MEMDEV\_Select, 2629, 2629, 2637, 2637, 2638, 2638, 2641, 2646, 2650, 2650, 2650, 2657, 2658, 2658, 2663, 2663, **2665**, 2674, 2674  
 GUI\_MEMDEV\_SerializeBMP, **2666**  
 GUI\_MEMDEV\_SerializeExBMP, **2667**  
 GUI\_MEMDEV\_SetAnimationCallback, **2692**, 2692  
 GUI\_MEMDEV\_SetBlurHQ, **2705**  
 GUI\_MEMDEV\_SetBlurLQ, **2706**  
 GUI\_MEMDEV\_SetDrawMemdev16bppFunc, **143**  
 GUI\_MEMDEV\_SetOrg, **2668**  
 GUI\_MEMDEV\_SetTimePerFrame, **2693**  
 GUI\_MEMDEV\_ShiftInWindow, **2697**  
 GUI\_MEMDEV\_ShiftOutWindow, **2697**  
 GUI\_MEMDEV\_SwapWindow, **2698**  
 GUI\_MEMDEV\_Write, 2638, 2658, **2669**  
 GUI\_MEMDEV\_WriteAlpha, **2670**  
 GUI\_MEMDEV\_WriteAlphaAt, **2671**  
 GUI\_MEMDEV\_WriteAt, **2672**  
 GUI\_MEMDEV\_WriteEx, **2673**  
 GUI\_MEMDEV\_WriteExAt, **2674**, 2674  
 GUI\_MEMDEV\_WriteOpaque, **2675**  
 GUI\_MEMDEV\_WriteOpaqueAt, **2676**  
 GUI\_MessageBox, **2507**  
 GUI\_MOUSE\_DRIVER\_PS2\_Init, **684**  
 GUI\_MOUSE\_DRIVER\_PS2\_OnRx, 683, **685**  
 GUI\_MOUSE\_GetState, **681**  
 GUI\_MOUSE\_StoreState, **682**, 682  
 GUI\_MoveRel, **353**  
 GUI\_MoveTo, **354**  
 GUI\_MOVIE\_Create, **653**  
 GUI\_MOVIE\_CreateEx, 650, **654**  
 GUI\_MOVIE\_Delete, **655**  
 GUI\_MOVIE\_DrawFrame, **656**  
 GUI\_MOVIE\_GetFrameIndex, **657**  
 GUI\_MOVIE\_GetInfo, **658**  
 GUI\_MOVIE\_GetInfoEx, 650, **659**  
 GUI\_MOVIE\_GetInfoH, **660**  
 GUI\_MOVIE\_GetNumFrames, **661**  
 GUI\_MOVIE\_GetPos, **662**  
 GUI\_MOVIE\_GotoFrame, **663**  
 GUI\_MOVIE\_Pause, **664**  
 GUI\_MOVIE\_Play, **665**  
 GUI\_MOVIE\_SetPeriod, **666**  
 GUI\_MOVIE\_SetpfNotify, **667**  
 GUI\_MOVIE\_SetPos, **668**  
 GUI\_MOVIE\_Show, 650, **669**  
 GUI\_MTOUCH\_Enable, 2716, 2717, **2722**  
 GUI\_MTOUCH\_GetEvent, 2717, **2723**  
 GUI\_MTOUCH\_GetTouchInput, 2717, **2724**  
 GUI\_MTOUCH\_IsEmpty, **2725**  
 GUI\_MTOUCH\_SetOrientation, **2726**  
 GUI\_MTOUCH\_StoreEvent, **2727**  
 GUI\_MULTIBUF\_Begin, 617, 649, **718**  
 GUI\_MULTIBUF\_BeginEx, **719**  
 GUI\_MULTIBUF\_Config, 714, 714, **720**  
 GUI\_MULTIBUF\_ConfigEx, **721**

GUI\_MULTIBUF\_Confirm, 715, 716, **722**  
 GUI\_MULTIBUF\_ConfirmEx, **723**  
 GUI\_MULTIBUF\_End, 617, 649, **724**  
 GUI\_MULTIBUF\_EndEx, **725**  
 GUI\_MULTIBUF\_GetNumBuffers, **726**  
 GUI\_MULTIBUF\_GetNumBuffersEx, **727**  
 GUI\_MULTIBUF\_UseSingleBuffer, **728**  
 GUI\_PID\_GetCurrentState, **673**  
 GUI\_PID\_GetState, **674**, 674, 710  
 GUI\_PID\_IsEmpty, **675**  
 GUI\_PID\_IsPressed, **676**  
 GUI\_PID\_SetHook, **677**  
 GUI\_PID\_StoreState, **678**, 711  
 GUI\_PNG\_Draw, **470**  
 GUI\_PNG\_DrawEx, **471**  
 GUI\_PNG\_GetXSize, **472**  
 GUI\_PNG\_GetXSizeEx, **473**  
 GUI\_PNG\_GetYSize, **474**  
 GUI\_PNG\_GetYSizeEx, **475**  
 GUI\_PreserveTrans, **323**  
 GUI\_QR\_Create, **377**  
 GUI\_QR\_CreateFramed, **378**  
 GUI\_QR\_Delete, **379**  
 GUI\_QR\_Draw, **380**  
 GUI\_QR\_GetInfo, **381**  
 GUI\_RegisterAfterInitHook, **106**, 106, 106  
 GUI\_RestoreContext, **390**  
 GUI\_RestoreUserAlpha, **324**, 324  
 GUI\_RotatePolygon, **361**, 361, 2625, 2625  
 GUI\_SaveContext, **391**  
 GUI\_SelectLayer, 2629, 2629, 2901, 2905, 2905, 2906, **2916**  
 GUI\_SelectLCD, **2677**, 2689  
 GUI\_SendKeyMsg, **731**  
 GUI\_SetAfterExitHook, **409**  
 GUI\_SetAfterInitHook, **410**  
 GUI\_SetAlphaMask8888, **330**  
 GUI\_SetBkColor, 219, 219, 321, 324, 361, 368, 373, 483, **513**, 802, 811, 811, 844, 895, 901, 918, 918,  
 980, 2608, 2614, 2620, 2622, 2637, 2657, 2657, 2658, 2674, 2901, 2901, 2905, 2906  
 GUI\_SetBkColorIndex, **514**  
 GUI\_SetClearTextRectMode, **242**  
 GUI\_SetClipRect, **290**, 290, 290  
 GUI\_SetColor, 209, 219, 219, 234, 234, 321, 321, 321, 321, 324, 324, 324, 324, 325, 325, 325, 359, 361,  
 361, 367, 367, 367, 368, 373, 382, **515**, 918, 918, 1266, 2409, 2514, 2608, 2614, 2620, 2622, 2657, 2658,  
 2663, 2789, 2789, 2789, 2789, 2901, 2901, 2905, 2905, 2905, 2905, 2905, 2906, 2906  
 GUI\_SetColorIndex, **516**  
 GUI\_SetControlHook, **411**  
 GUI\_SetDefaultBkColor, **518**  
 GUI\_SetDefaultColor, **517**  
 GUI\_SetDefaultFont, 106, **580**  
 GUI\_SetDrawMode, **291**, 291, 291, 357, 2657  
 GUI\_SetFallbackFont, **581**  
 GUI\_SetFont, 210, 219, 265, 266, 325, 361, 368, 540, 540, **582**, 582, 582, 582, 582, 582, 582, 741, 1266,  
 2641, 2663  
 GUI\_SetFuncDrawAlpha, **138**  
 GUI\_SetFuncDrawCircle, **145**  
 GUI\_SetFuncDrawLine, **148**  
 GUI\_SetFuncDrawRoundedRect, **147**  
 GUI\_SetFuncFillCircle, **144**  
 GUI\_SetFuncFillRoundedRect, **146**  
 GUI\_SetFuncGetFallbackFont, **583**  
 GUI\_SetFuncGetpPalConvTable, **142**  
 GUI\_SetLayerAlphaEx, **2917**  
 GUI\_SetLayerPosEx, **2918**  
 GUI\_SetLayerSizeEx, **2919**  
 GUI\_SetLayerVisEx, **2920**  
 GUI\_SetLBorder, **246**, 2622  
 GUI\_SetLineStyle, **355**  
 GUI\_SetOnErrorFunc, **107**  
 GUI\_SetOnLogFunc, **108**  
 GUI\_SetOnWarnFunc, **109**  
 GUI\_SetOrg, 2789, 2789, **2794**  
 GUI\_SetOrientation, **2954**  
 GUI\_SetOrientationEx, **2955**  
 GUI\_SetPenSize, 219, **292**, 368, 368, 368, 2608, 2620, 2620, 2620, 2622, 2637, 2658, 2717  
 GUI\_SetpfMemcpy, **123**  
 GUI\_SetpfMemset, **124**

GUI\_SetpfStrcmp, **125**  
 GUI\_SetpfStrcpy, **126**  
 GUI\_SetpfStrlen, **127**  
 GUI\_SetRefreshHook, **412**  
 GUI\_SetSignalEventFunc, **2884**, 2884  
 GUI\_SetStreamedBitmapHook, **344**  
 GUI\_SetTextAlign, **247**, 247, 368  
 GUI\_SetTextMode, 219, 219, 219, 219, 219, 233, 234, **243**, 325, 368, 1266, 2663, 2674, 2789, 2901  
 GUI\_SetTextStyle, **244**  
 GUI\_SetTimeSlice, **787**  
 GUI\_SetUserAlpha, 324, **326**  
 GUI\_SetWaitEventFunc, **2885**, 2885  
 GUI\_SetWaitEventTimedFunc, **2886**, 2886  
 GUI\_ShowMissingCharacters, **239**  
 GUI\_SIF\_CreateFont, **537**, 537, 538  
 GUI\_SIF\_DeleteFont, **538**, 538  
 GUI\_SOFTLAYER\_Enable, 2912, **2922**  
 GUI\_SOFTLAYER\_MULTIBUF\_Enable, **2925**  
 GUI\_SOFTLAYER\_Refresh, **2923**  
 GUI\_SOFTLAYER\_SetCompositeColor, **2924**  
 GUI\_SPLINE\_Create, **384**  
 GUI\_SPLINE\_Delete, **385**  
 GUI\_SPLINE\_Draw, **386**  
 GUI\_SPLINE\_DrawAA, **387**  
 GUI\_SPLINE\_GetXSize, **389**  
 GUI\_SPLINE\_GetY, **388**  
 GUI\_SPRITE\_Create, **2761**  
 GUI\_SPRITE\_CreateAnim, **2762**  
 GUI\_SPRITE\_CreateEx, **2763**  
 GUI\_SPRITE\_CreateExAnim, **2764**  
 GUI\_SPRITE\_CreateHidden, **2765**  
 GUI\_SPRITE\_CreateHiddenEx, **2766**  
 GUI\_SPRITE\_Delete, **2767**  
 GUI\_SPRITE\_GetState, **2768**  
 GUI\_SPRITE\_Hide, **2769**  
 GUI\_SPRITE\_SetBitmap, **2770**  
 GUI\_SPRITE\_SetBitmapAndPosition, **2771**  
 GUI\_SPRITE\_SetLoop, **2772**  
 GUI\_SPRITE\_SetPosition, **2773**  
 GUI\_SPRITE\_Show, **2774**  
 GUI\_SPRITE\_StartAnim, **2775**  
 GUI\_SPRITE\_StopAnim, **2776**  
 GUI\_SPY\_Process, **2862**, 2862  
 GUI\_SPY\_SetMemHandler, **2863**  
 GUI\_SPY\_StartServer, **2864**  
 GUI\_SPY\_StartServerEx, **2865**  
 GUI\_SPY\_X\_StartServer, **2856**  
 GUI\_StoreKey, **736**  
 GUI\_StoreKeyMsg, **730**  
 GUI\_TIMER\_Create, **793**  
 GUI\_TIMER\_Delete, **794**  
 GUI\_TIMER\_Restart, **795**  
 GUI\_TIMER\_SetPeriod, **796**  
 GUI\_TOUCH\_CalcCoefficients, **706**  
 GUI\_TOUCH\_Calibrate, 692, 692, **698**, 702, 702  
 GUI\_TOUCH\_CalibratePoint, **707**  
 GUI\_TOUCH\_EnableCalibration, **708**  
 GUI\_TOUCH\_Exec, **699**  
 GUI\_TOUCH\_GetState, **687**  
 GUI\_TOUCH\_GetxPhys, **700**  
 GUI\_TOUCH\_GetyPhys, **700**  
 GUI\_TOUCH\_SetOrientation, 692, **701**, 702  
 GUI\_TOUCH\_StoreState, **688**, 688  
 GUI\_TOUCH\_StoreStateEx, **689**, 689  
 GUI\_TOUCH\_TransformPoint, **709**  
 GUI\_TTF\_CreateFont, **539**, 540, 540  
 GUI\_TTF\_CreateFontAA, **541**  
 GUI\_TTF\_EmboldenFont, **542**  
 GUI\_TTF\_EmboldenFontEx, **543**  
 GUI\_TTF\_GetFamilyName, **544**  
 GUI\_TTF\_GetStyleName, **545**  
 GUI\_TTF\_ObliqueFont, **546**  
 GUI\_TTF\_ObliqueFontEx, **547**  
 GUI\_UC\_ConvertUC2UTF8, **743**  
 GUI\_UC\_ConvertUTF82UC, **744**  
 GUI\_UC\_DispString, **755**

GUI\_UC\_EnableBIDI, **745**, 778  
 GUI\_UC\_EnableThai, **746**  
 GUI\_UC\_Encode, **747**  
 GUI\_UC\_GetBaseDir, **748**  
 GUI\_UC\_GetCharCode, **749**, 750, 750  
 GUI\_UC\_GetCharSize, **750**, 750  
 GUI\_UC\_SetBaseDir, **751**  
 GUI\_UC\_SetEncodeNone, **753**  
 GUI\_UC\_SetEncodesSJIS, **752**  
 GUI\_UC\_SetEncodeUTF8, 740, 740, 741, **754**  
 GUI\_VNC\_AttachToLayer, **2742**  
 GUI\_VNC\_EnableFileTransfer, **2743**  
 GUI\_VNC\_EnableKeyboardInput, **2744**  
 GUI\_VNC\_GetNumConnections, **2745**  
 GUI\_VNC\_Process, **2746**, 2746  
 GUI\_VNC\_RingBell, **2747**  
 GUI\_VNC\_SetFS\_API, **2748**  
 GUI\_VNC\_SetLockFrame, **2749**  
 GUI\_VNC\_SetPassword, **2750**  
 GUI\_VNC\_SetProgName, **2751**  
 GUI\_VNC\_SetRetryCount, **2752**  
 GUI\_VNC\_SetSize, **2753**  
 GUI\_VNC\_X\_StartServer, 2740, **2754**  
 GUI\_VNC\_X\_StartServerFT, **2755**  
 GUI\_WaitEvent, **2887**, 2887  
 GUI\_WaitKey, **737**  
 GUI\_Warn, **791**  
 GUI\_WrapGetNumLines, **240**  
 GUI\_X\_Delay, **118**, 627  
 GUI\_X\_ExecIdle, **119**, 2882  
 GUI\_X\_GetTaskId, **2891**, 2898, 2898, 2899  
 GUI\_X\_GetTime, **120**  
 GUI\_X\_Init, **117**  
 GUI\_X\_InitOS, **2892**, 2898, 2898, 2899  
 GUI\_X\_Lock, **2893**, 2898, 2898, 2899  
 GUI\_X\_SignalEvent, 2884, 2889, **2894**, 2898, 2898  
 GUI\_X\_Unlock, **2895**, 2898, 2898, 2899  
 GUI\_X\_WaitEvent, 2885, 2889, **2896**, 2898, 2898  
 GUI\_X\_WaitEventTimed, 2886, 2889, **2897**, 2898  
 GUI\_XBF\_CreateFont, **548**, 549  
 GUI\_XBF\_DeleteFont, **550**  
 GUI\_YUV\_Create, **398**  
 GUI\_YUV\_CreateEx, **399**  
 GUI\_YUV\_Delete, **400**  
 GUI\_YUV\_DeleteEx, **401**  
 GUI\_YUV\_GetpData, **402**  
 GUI\_YUV\_GetpDataEx, **403**  
 GUI\_YUV\_InvalidateArea, **404**  
 GUI\_YUV\_SetPeriod, **405**  
 GUI\_YUV\_SetPeriodEx, **406**  
 GUICC\_M1555I\_SetCustColorConv, **134**  
 GUICC\_M4444I\_SetCustColorConv, **134**  
 GUICC\_M565\_SetCustColorConv, **134**  
 GUICC\_M8888I\_SetCustColorConv, **134**  
 GUICC\_M888\_SetCustColorConv, **134**  
 GUIDRV\_BitPlains\_Config, **2964**  
 GUIDRV\_DCache\_AddDriver, 2966, **2967**  
 GUIDRV\_DCache\_SetModelbpp, 2965, **2968**  
 GUIDRV\_Dist\_AddDriver, 2969, 2969, **2970**, 2970, 2970  
 GUIDRV\_FlexColor\_Config, 2973, **2979**  
 GUIDRV\_FlexColor\_SetFunc, 2974, **2975**  
 GUIDRV\_FlexColor\_SetOrientation, **2980**  
 GUIDRV\_FlexColor\_SetReadFunc66709\_B16, **2983**  
 GUIDRV\_FlexColor\_SetReadFunc66720\_B16, **2988**  
 GUIDRV\_FlexColor\_SetReadFunc66772\_B16, **2990**  
 GUIDRV\_FlexColor\_SetReadFunc66772\_B8, **2989**  
 GUIDRV\_IST3088\_SetBus16, **2993**  
 GUIDRV\_S1D13513\_Config, **3001**  
 GUIDRV\_S1D13513\_SetBus16, **3002**  
 GUIDRV\_S1D13748\_Config, **3005**  
 GUIDRV\_S1D13748\_SetBus16, **3006**  
 GUIDRV\_S1D13781\_Config, **3010**  
 GUIDRV\_S1D13781\_SetBusSPI, **3011**  
 GUIDRV\_S1D13781\_SetOrientation, **3012**  
 GUIDRV\_S1D13L01\_Config, **3010**  
 GUIDRV\_S1D13L01\_SetBusSPI, **3011**

GUIDRV\_S1D13L01\_SetOrientation, **3012**  
 GUIDRV\_S1D13L02\_Config, **3005**  
 GUIDRV\_S1D13L02\_SetBus16, **3006**  
 GUIDRV\_S1D13L04\_Config, **3001**  
 GUIDRV\_S1D13L04\_SetBus16, **3002**  
 GUIDRV\_S1D15G00\_Config, **3016**, 3017  
 GUIDRV\_S1D15G00\_SetBus8, **3017**, 3017  
 GUIDRV\_SH\_MEM\_3\_Config, **3021**  
 GUIDRV\_SH\_MEM\_3\_SetBus8, **3022**  
 GUIDRV\_SH\_MEM\_Config, **3021**, 3023  
 GUIDRV\_SH\_MEM\_SetBus8, **3022**, 3023  
 GUIDRV\_SLin\_Config, 2936, 3034  
 GUIDRV\_SLin\_SetBus8, 2937, 3034  
 GUIDRV\_SLin\_Sets1D13700, 2937, **3029**, 3034  
 GUIDRV\_SLin\_SetSSD1325, **3030**  
 GUIDRV\_SLin\_SetSSD1848, **3031**  
 GUIDRV\_SLin\_SetT6963, **3032**  
 GUIDRV\_SLin\_SetUC1617, **3033**  
 GUIDRV\_SLinEPD\_Config, **3038**, 3044  
 GUIDRV\_SLinEPD\_EnableFastMode, **3039**  
 GUIDRV\_SLinEPD\_EnablePartialMode, **3040**  
 GUIDRV\_SLinEPD\_SetBus8, **3041**, 3044  
 GUIDRV\_SLinEPD\_SetSSD1673, **3042**, 3044  
 GUIDRV\_SLinEPD\_SetUC8451, **3043**  
 GUIDRV\_SPage\_Config, **3049**, 3061  
 GUIDRV\_SPage\_Set1502, **3051**  
 GUIDRV\_SPage\_Set1510, **3052**  
 GUIDRV\_SPage\_Set1512, **3053**  
 GUIDRV\_SPage\_SetBus8, **3050**, 3061  
 GUIDRV\_SPage\_SetST75256, **3054**  
 GUIDRV\_SPage\_SetST75320, **3055**  
 GUIDRV\_SPage\_SetST7591, **3056**  
 GUIDRV\_SPage\_SetUC1610, **3057**  
 GUIDRV\_SPage\_SetUC1611, **3058**, 3061  
 GUIDRV\_SPage\_SetUC1628, **3059**  
 GUIDRV\_SPage\_SetUC1638, **3060**  
 GUIDRV\_SSD1322\_Config, **3063**, 3065  
 GUIDRV\_SSD1322\_SetBus8, **3064**, 3065  
 GUIDRV\_SSD1926\_Config, **3068**, 3070  
 GUIDRV\_SSD1926\_SetBus16, **3069**, 3070  
 GUIDRV\_UC1698G\_Config, **3073**  
 GUIDRV\_UC1698G\_SetBus16, **3075**  
 GUIDRV\_UC1698G\_SetBus8, **3074**  
 GUIMTDRV\_TangoC32\_Init, **3140**  
 GUITASK\_GetMaxTask, **110**  
 GUITASK\_SetMaxTask, **111**  
 GUITDRV\_ADS7846\_Config, **3143**  
 GUITDRV\_ADS7846\_Exec, **3145**  
 GUITDRV\_ADS7846\_GetLastVal, **3146**  
 HEADER\_AddItem, **1372**, 1398, 1398  
 HEADER\_Create, **1373**, 1398  
 HEADER\_CreateAttached, **1374**  
 HEADER\_CreateEx, **1375**  
 HEADER\_CreateIndirect, **1376**  
 HEADER\_CreateUser, **1377**  
 HEADER\_DeleteItem, **1378**  
 HEADER\_GetBkColor, **1379**  
 HEADER\_GetBorderH, **1380**  
 HEADER\_GetBorderV, **1381**  
 HEADER\_GetColumnFromPos, **1382**  
 HEADER\_GetDefaultBkColor, **1383**  
 HEADER\_GetDefaultBorderH, **1384**  
 HEADER\_GetDefaultBorderV, **1385**  
 HEADER\_GetDefaultCursor, **1386**  
 HEADER\_GetDefaultFont, **1387**  
 HEADER\_GetDefaultTextColor, **1388**  
 HEADER\_GetFont, **1389**  
 HEADER\_GetHeight, **1390**  
 HEADER\_GetItemText, **1391**  
 HEADER\_GetItemWidth, **1392**  
 HEADER\_GetNumItems, **1393**  
 HEADER\_GetSel, **1394**  
 HEADER\_GetTextColor, **1395**  
 HEADER\_GetUserData, **1396**  
 HEADER\_SetBitmap, **1397**  
 HEADER\_SetBitmapEx, **1398**, 1398, 1398

HEADER\_SetBkColor, **1399**  
 HEADER\_SetBMP, **1400**  
 HEADER\_SetBMPEX, **1401**  
 HEADER\_SetBorderH, **1402**  
 HEADER\_SetBorderV, **1403**  
 HEADER\_SetDefaultBkColor, **1404**  
 HEADER\_SetDefaultBorderH, **1405**  
 HEADER\_SetDefaultBorderV, **1406**  
 HEADER\_SetDefaultCursor, **1407**  
 HEADER\_SetDefaultFont, **1398, 1408**  
 HEADER\_SetDefaultTextColor, **1398, 1409**  
 HEADER\_SetDragLimit, **1410**  
 HEADER\_SetFixed, **1411**  
 HEADER\_SetFont, **1412**  
 HEADER\_SetHeight, **1413**  
 HEADER\_SetItemText, **1414**  
 HEADER\_SetItemWidth, **1415**  
 HEADER\_SetScrollPos, **1416**  
 HEADER\_SetSkinFlexProps, **2547**  
 HEADER\_SetStreamedBitmap, **1417**  
 HEADER\_SetStreamedBitmapEx, **1418**  
 HEADER\_SetTextAlign, **1419**  
 HEADER\_SetTextColor, **1420, 1614**  
 HEADER\_SetUserData, **1421**  
 ICONVIEW\_AddBitmapItem, **1427**  
 ICONVIEW\_AddStreamedBitmapItem, **1428**  
 ICONVIEW\_CreateEx, **1429**  
 ICONVIEW\_CreateIndirect, **1430**  
 ICONVIEW\_CreateUser, **1431**  
 ICONVIEW\_DeleteItem, **1432**  
 ICONVIEW\_GetBkColor, **1434**  
 ICONVIEW\_GetFont, **1435**  
 ICONVIEW\_GetItemBitmap, **1436**  
 ICONVIEW\_GetItemText, **1437**  
 ICONVIEW\_GetItemUserData, **1438**  
 ICONVIEW\_GetNumItems, **1439**  
 ICONVIEW\_GetReleasedItem, **1440**  
 ICONVIEW\_GetSel, **1441**  
 ICONVIEW\_GetTextColor, **1442**  
 ICONVIEW\_GetUserData, **1443**  
 ICONVIEW\_InsertBitmapItem, **1444**  
 ICONVIEW\_InsertStreamedBitmapItem, **1445**  
 ICONVIEW\_OwnerDraw, **1446, 1454**  
 ICONVIEW\_SetBitmapItem, **1447**  
 ICONVIEW\_SetBkColor, **1448**  
 ICONVIEW\_SetFont, **1449**  
 ICONVIEW\_SetFrame, **1450**  
 ICONVIEW\_SetIconAlign, **1451**  
 ICONVIEW\_SetItemText, **1452**  
 ICONVIEW\_SetItemUserData, **1453**  
 ICONVIEW\_SetOwnerDraw, **1454**  
 ICONVIEW\_SetSel, **1455**  
 ICONVIEW\_SetSpace, **1456**  
 ICONVIEW\_SetStreamedBitmapItem, **1457**  
 ICONVIEW\_SetTextAlign, **1458**  
 ICONVIEW\_SetTextColor, **1459**  
 ICONVIEW\_SetUserData, **1460**  
 ICONVIEW\_SetWrapMode, **1461**  
 IMAGE\_CreateEx, **1468**  
 IMAGE\_CreateIndirect, **1469**  
 IMAGE\_CreateUser, **1470**  
 IMAGE\_EnableLQ, **1471**  
 IMAGE\_GetImageSize, **1472**  
 IMAGE\_GetUserData, **1473**  
 IMAGE\_SetAlign, **1474**  
 IMAGE\_SetAlpha, **1475**  
 IMAGE\_SetAngle, **1476**  
 IMAGE\_SetBitmap, **1477**  
 IMAGE\_SetBMP, **1478**  
 IMAGE\_SetBMPEX, **1479**  
 IMAGE\_SetDTA, **1478**  
 IMAGE\_SetDTAEX, **1479**  
 IMAGE\_SetGIF, **1478**  
 IMAGE\_SetGIFEX, **1479**  
 IMAGE\_SetJPEG, **1478**  
 IMAGE\_SetJPEGEX, **1479**

IMAGE\_SetOffset, **1480**  
 IMAGE\_SetPNG, **1478**  
 IMAGE\_SetPNGEx, **1479**  
 IMAGE\_SetScale, **1481**  
 IMAGE\_SetTiled, **1482**  
 IMAGE\_SetUserData, **1483**  
 KEYBOARD\_CreateIndirect, **1492**  
 KEYBOARD\_CreateUser, **1491**  
 KEYBOARD\_ExportLayout, **1493**, 1493  
 KEYBOARD\_ExportPatternFile, **1494**  
 KEYBOARD\_SetColor, **1497**  
 KEYBOARD\_SetFont, **1498**  
 KEYBOARD\_SetLayout, **1495**, 1495  
 KEYBOARD\_SetPeriod, **1499**  
 KEYBOARD\_SetRadius, **1500**  
 KEYBOARD\_SetSpace, **1501**  
 KEYBOARD\_SetStreamedLayout, **1496**, 1496, 1496  
 KNOB\_AddValue, **2360**  
 KNOB\_CreateEx, **2361**  
 KNOB\_CreateIndirect, **2362**  
 KNOB\_CreateUser, **2363**  
 KNOB\_GetUserData, **2364**  
 KNOB\_GetValue, **2365**  
 KNOB\_SetBkColor, **2366**  
 KNOB\_SetBkDevice, **2367**  
 KNOB\_SetDevice, **2368**  
 KNOB\_SetInvert, **2369**  
 KNOB\_SetKeyValue, **2370**  
 KNOB\_SetOffset, **2371**  
 KNOB\_SetPeriod, **2372**  
 KNOB\_SetPos, **2373**  
 KNOB\_SetRange, **2374**  
 KNOB\_SetRotateHQ, **2375**  
 KNOB\_SetRotateLQ, **2375**  
 KNOB\_SetSnap, **2376**  
 KNOB\_SetTickSize, **2377**  
 KNOB\_SetUserData, **2378**  
 LCD\_ControlCache, **3137**  
 LCD\_GetBitsPerPixel, **3102**  
 LCD\_GetBitsPerPixelEx, **3103**  
 LCD\_GetMirrorX, 692  
 LCD\_GetMirrorXEx, 702  
 LCD\_GetMirrorY, 692  
 LCD\_GetMirrorYEx, 702  
 LCD\_GetNumColors, **3104**  
 LCD\_GetNumColorsEx, **3105**  
 LCD\_GetNumLayers, **2921**  
 LCD\_GetPosEx, **3106**  
 LCD\_GetSwapXY, 692, 2964, 3023, 3044, 3061, 3065  
 LCD\_GetSwapXYEx, 702  
 LCD\_GetVRAMAddr, **3107**  
 LCD\_GetVRAMAddrEx, **3108**  
 LCD\_GetVXSize, **3109**  
 LCD\_GetVXSizeEx, **3110**  
 LCD\_GetVYSize, **3109**  
 LCD\_GetVYSizeEx, **3110**  
 LCD\_GetXMag, **3111**  
 LCD\_GetXMagEx, **3112**  
 LCD\_GetXSize, 710, 1947, **3113**  
 LCD\_GetXSizeEx, **3114**  
 LCD\_GetYMag, **3111**  
 LCD\_GetYMagEx, **3112**  
 LCD\_GetYSize, 710, 1947, **3113**  
 LCD\_GetYSizeEx, **3114**  
 LCD\_OffEx, **3124**  
 LCD\_On, **3125**  
 LCD\_OnEx, **3126**  
 LCD\_Refresh, **3127**  
 LCD\_RefreshEx, **3128**  
 LCD\_ROTATE\_AddDriver, **2944**  
 LCD\_ROTATE\_AddDriverEx, **2945**  
 LCD\_ROTATE\_DecSel, **2946**  
 LCD\_ROTATE\_DecSelEx, **2947**  
 LCD\_ROTATE\_IncSel, **2948**  
 LCD\_ROTATE\_IncSelEx, **2949**  
 LCD\_ROTATE\_SetCallback, **2950**



LCD\_ROTATE\_SetSel, **2951**  
 LCD\_ROTATE\_SetSelEx, **2952**  
 LCD\_SetAlphaEx, **3115**  
 LCD\_SetAlphaModeEx, **3116**  
 LCD\_SetBufferPtr, **3121**, 3121  
 LCD\_SetBufferPtrEx, 715, **3122**  
 LCD\_SetChromaEx, **3117**  
 LCD\_SetChromaModeEx, **3118**  
 LCD\_SetDevFunc, 715, **3129**  
 LCD\_SetLUT, **503**  
 LCD\_SetLUTEntryEx, **505**  
 LCD\_SetLUTEx, 502, **504**, 2904  
 LCD\_SetMaxNumColors, **3133**  
 LCD\_SetPosEx, **3119**  
 LCD\_SetSizeEx, 113, 2789, 2907, 2907, 2909, 2909, 2912, 2936, 2964, 2964, 2965, 2970, 2973, 2998,  
 3017, 3023, 3034, 3044, 3044, 3061, 3061, 3065, 3065, 3069, 3081, **3134**  
 LCD\_SetVisEx, **3120**  
 LCD\_SetVRAMAddrEx, 113, 2907, 2907, 2909, 2912, 2964, 2998, **3135**  
 LCD\_SetVSizeEx, 113, **2788**, 2789, 2912, 2936, 2964, 2964, 2965, 2970, 2973, 2998, 3017, 3034, 3044,  
 3044, 3061, 3061, 3065, 3065, 3069, **2788**  
 LISTBOX\_AddString, **1518**  
 LISTBOX\_Callback, 987  
 LISTBOX\_Create, **1519**, 2426  
 LISTBOX\_CreateAsChild, **1520**  
 LISTBOX\_CreateEx, **1521**  
 LISTBOX\_CreateIndirect, **1522**, 2453  
 LISTBOX\_CreateUser, **1523**  
 LISTBOX\_DecSel, **1524**  
 LISTBOX\_DeleteItem, **1525**  
 LISTBOX\_EnableMotion, **1526**  
 LISTBOX\_EnableWrapMode, **1527**  
 LISTBOX\_GetBkColor, **1528**  
 LISTBOX\_GetDefaultBkColor, **1529**  
 LISTBOX\_GetDefaultFont, **1530**  
 LISTBOX\_GetDefaultScrollStepH, **1531**  
 LISTBOX\_GetDefaultTextAlign, **1532**  
 LISTBOX\_GetDefaultTextColor, **1533**  
 LISTBOX\_GetFont, **1534**  
 LISTBOX\_GetItemDisabled, **1535**  
 LISTBOX\_GetItemSel, **1536**  
 LISTBOX\_GetItemSpacing, **1537**  
 LISTBOX\_GetItemText, **1538**  
 LISTBOX\_GetMulti, **1539**  
 LISTBOX\_GetNumItems, **1540**  
 LISTBOX\_GetOwner, **1541**  
 LISTBOX\_GetScrollStepH, **1542**  
 LISTBOX\_GetSel, **1543**  
 LISTBOX\_GetTextAlign, **1544**  
 LISTBOX\_GetTextColor, **1545**  
 LISTBOX\_GetUserData, **1546**  
 LISTBOX\_GetVisItemIndices, **1547**  
 LISTBOX\_IncSel, **1548**  
 LISTBOX\_InsertString, **1549**  
 LISTBOX\_InvalidItem, **1550**  
 LISTBOX\_IsItemPartiallyVisible, **1551**  
 LISTBOX\_OwnerDraw, **1552**, 1567, 1567  
 LISTBOX\_SetAutoScrollH, **1553**  
 LISTBOX\_SetAutoScrollV, **1554**  
 LISTBOX\_SetBkColor, **1555**  
 LISTBOX\_SetDefaultBkColor, **1556**  
 LISTBOX\_SetDefaultFont, **1557**  
 LISTBOX\_SetDefaultScrollStepH, **1558**  
 LISTBOX\_SetDefaultTextAlign, **1559**  
 LISTBOX\_SetDefaultTextColor, **1560**  
 LISTBOX\_SetFixedScrollPos, **1561**  
 LISTBOX\_SetFont, **1562**  
 LISTBOX\_SetItemDisabled, **1563**  
 LISTBOX\_SetItemSel, **1564**  
 LISTBOX\_SetItemSpacing, **1565**  
 LISTBOX\_SetMulti, **1566**  
 LISTBOX\_SetOwnerDraw, **1567**  
 LISTBOX\_SetScrollbarColor, **1569**  
 LISTBOX\_SetScrollbarWidth, **1570**  
 LISTBOX\_SetScrollStepH, **1571**  
 LISTBOX\_SetSel, **1572**  
 LISTBOX\_SetString, **1573**

LISTBOX\_SetText, 2454, 2455  
 LISTBOX\_SetTextAlign, **1574**  
 LISTBOX\_SetTextColor, **1575**  
 LISTBOX\_SetUserData, **1576**  
 LISTVIEW\_AddColumn, **1586**  
 LISTVIEW\_AddRow, **1587**  
 LISTVIEW\_Clear, **1588**  
 LISTVIEW\_CompareDec, **1589**  
 LISTVIEW\_CompareText, **1590**  
 LISTVIEW\_Create, **1591**, 1614  
 LISTVIEW\_CreateAttached, **1592**  
 LISTVIEW\_CreateEx, **1593**, 1947  
 LISTVIEW\_CreateIndirect, **1594**  
 LISTVIEW\_CreateUser, **1595**  
 LISTVIEW\_DecSel, **1596**  
 LISTVIEW\_DeleteAllRows, **1597**  
 LISTVIEW\_DeleteColumn, **1598**  
 LISTVIEW\_DeleteRow, **1599**  
 LISTVIEW\_DisableRow, **1600**  
 LISTVIEW\_DisableSort, **1601**  
 LISTVIEW\_EnableCellSelect, **1602**  
 LISTVIEW\_EnableMotion, **1603**, 1947  
 LISTVIEW\_EnableRow, **1604**  
 LISTVIEW\_EnableSort, **1605**  
 LISTVIEW\_GetBkColor, **1606**  
 LISTVIEW\_GetDefaultBkColor, **1607**  
 LISTVIEW\_GetDefaultFont, **1608**  
 LISTVIEW\_GetDefaultGridColor, **1609**  
 LISTVIEW\_GetDefaultScrollStepH, **1610**  
 LISTVIEW\_GetDefaultTextColor, **1611**  
 LISTVIEW\_GetFont, **1612**  
 LISTVIEW\_GetGridColor, **1613**  
 LISTVIEW\_GetHeader, **1614**, 1614  
 LISTVIEW\_GetItemRect, **1615**  
 LISTVIEW\_GetItemText, **1616**  
 LISTVIEW\_GetItemTextLen, **1617**  
 LISTVIEW\_GetItemTextSorted, **1618**  
 LISTVIEW\_GetLBorder, **1619**  
 LISTVIEW\_GetNumColumns, **1620**  
 LISTVIEW\_GetNumRows, **1621**  
 LISTVIEW\_GetRBorder, **1622**  
 LISTVIEW\_GetScrollStepH, **1623**  
 LISTVIEW\_GetSel, **1624**  
 LISTVIEW\_GetSelCol, **1625**  
 LISTVIEW\_GetSelUnsorted, **1626**  
 LISTVIEW\_GetTextAlign, **1627**  
 LISTVIEW\_GetTextColor, **1628**  
 LISTVIEW\_GetUserData, **1629**  
 LISTVIEW\_GetUserDataRow, **1630**  
 LISTVIEW\_GetVisRowIndices, **1631**  
 LISTVIEW\_GetWrapMode, **1632**  
 LISTVIEW\_IncSel, **1633**  
 LISTVIEW\_InsertRow, **1634**  
 LISTVIEW\_IsRowPartiallyVisible, **1635**  
 LISTVIEW\_OwnerDraw, **1636**  
 LISTVIEW\_RowIsDisabled, **1637**  
 LISTVIEW\_SetAutoScrollH, **1638**  
 LISTVIEW\_SetAutoScrollV, **1639**  
 LISTVIEW\_SetBkColor, **1640**  
 LISTVIEW\_SetColumnWidth, **1641**  
 LISTVIEW\_SetCompareFunc, **1642**, 1642  
 LISTVIEW\_SetDefaultBkColor, **1644**  
 LISTVIEW\_SetDefaultFont, **1645**  
 LISTVIEW\_SetDefaultGridColor, **1646**  
 LISTVIEW\_SetDefaultScrollStepH, **1647**  
 LISTVIEW\_SetDefaultTextColor, **1648**  
 LISTVIEW\_SetFixed, **1649**  
 LISTVIEW\_SetFont, **1650**  
 LISTVIEW\_SetGridVis, **1651**  
 LISTVIEW\_SetHeaderHeight, **1652**  
 LISTVIEW\_SetItemBitmap, **1653**  
 LISTVIEW\_SetItemBkColor, **1654**  
 LISTVIEW\_SetItemText, **1655**  
 LISTVIEW\_SetItemTextColor, **1656**  
 LISTVIEW\_SetItemTextSorted, **1657**  
 LISTVIEW\_SetLBorder, **1658**

LISTVIEW\_SetOwnerDraw, **1659**  
 LISTVIEW\_SetRBorder, **1660**  
 LISTVIEW\_SetRowHeight, **1661**  
 LISTVIEW\_SetScrollPos, **1662**  
 LISTVIEW\_SetScrollStepH, **1663**  
 LISTVIEW\_SetSel, **1664**  
 LISTVIEW\_SetSelCol, **1665**  
 LISTVIEW\_SetSelUnsorted, **1666**  
 LISTVIEW\_SetSort, **1667**  
 LISTVIEW\_SetTextAlign, **1668**  
 LISTVIEW\_SetTextColor, **1669**  
 LISTVIEW\_SetUserData, **1670**  
 LISTVIEW\_SetUserDataRow, **1671**  
 LISTVIEW\_SetWrapMode, **1672**  
 LISTWHEEL\_AddString, **2383**  
 LISTWHEEL\_CreateEx, **2384**, 2384  
 LISTWHEEL\_CreateIndirect, **2385**  
 LISTWHEEL\_CreateUser, **2386**  
 LISTWHEEL\_GetBkColor, **2387**  
 LISTWHEEL\_GetFont, **2388**  
 LISTWHEEL\_GetItemFromPos, **2389**  
 LISTWHEEL\_GetItemText, **2390**  
 LISTWHEEL\_GetLBorder, **2391**  
 LISTWHEEL\_GetLineHeight, **2392**  
 LISTWHEEL\_GetNumItems, **2393**  
 LISTWHEEL\_GetPos, **2394**  
 LISTWHEEL\_GetRBorder, **2395**  
 LISTWHEEL\_GetSel, **2396**  
 LISTWHEEL\_GetSnapPosition, **2397**  
 LISTWHEEL\_GetTextAlign, **2398**  
 LISTWHEEL\_GetTextColor, **2399**  
 LISTWHEEL\_GetUserData, **2400**  
 LISTWHEEL\_IsMoving, **2401**  
 LISTWHEEL\_MoveToPos, **2402**  
 LISTWHEEL\_OwnerDraw, **2403**, 2409  
 LISTWHEEL\_SetBkColor, **2404**  
 LISTWHEEL\_SetDeceleration, **2405**  
 LISTWHEEL\_SetFont, **2406**  
 LISTWHEEL\_SetLBorder, **2407**  
 LISTWHEEL\_SetLineHeight, **2408**  
 LISTWHEEL\_SetOwnerDraw, **2409**  
 LISTWHEEL\_SetPos, **2410**  
 LISTWHEEL\_SetRBorder, **2411**  
 LISTWHEEL\_SetSel, **2412**  
 LISTWHEEL\_SetSnapPosition, **2413**  
 LISTWHEEL\_SetText, **2414**, 2414  
 LISTWHEEL\_SetTextAlign, **2415**  
 LISTWHEEL\_SetTextColor, **2416**  
 LISTWHEEL\_SetTimerPeriod, **2417**  
 LISTWHEEL\_SetUserData, **2418**  
 LISTWHEEL\_SetVelocity, **2419**  
 MENU\_AddItem, **1680**  
 MENU\_Attach, **1681**  
 MENU\_Callback, 1676  
 MENU\_CreateEx, **1682**  
 MENU\_CreateIndirect, **1683**  
 MENU\_CreateUser, **1684**  
 MENU\_DeleteItem, **1685**  
 MENU\_DisableItem, **1686**  
 MENU\_EnableItem, **1687**  
 MENU\_GetBkColor, **1688**  
 MENU\_GetDefaultBkColor, **1689**  
 MENU\_GetDefaultBorderSize, **1690**  
 MENU\_GetDefaultEffect, **1691**  
 MENU\_GetDefaultFont, **1692**  
 MENU\_GetDefaultTextColor, **1693**  
 MENU\_GetFont, **1694**  
 MENU\_GetItem, **1695**  
 MENU\_GetItemText, **1696**  
 MENU\_GetNumItems, **1697**  
 MENU\_GetOwner, **1698**  
 MENU\_GetTextColor, **1699**  
 MENU\_GetUserData, **1700**  
 MENU\_InsertItem, **1701**  
 MENU\_Popup, **1702**  
 MENU\_SetBkColor, **1703**

MENU\_SetBorderSize, **1704**, 1704, 1704, 1704  
 MENU\_SetDefaultBkColor, **1705**  
 MENU\_SetDefaultBorderSize, **1706**  
 MENU\_SetDefaultEffect, **1707**  
 MENU\_SetDefaultFont, **1708**  
 MENU\_SetDefaultTextColor, **1709**  
 MENU\_SetFont, **1710**  
 MENU\_SetItem, **1711**  
 MENU\_SetOwner, **1712**  
 MENU\_SetSel, **1713**  
 MENU\_SetSkinFlexProps, **2553**  
 MENU\_SetTextColor, **1714**  
 MENU\_SetUserData, **1715**  
 MENU\_SkinEnableArrow, **2554**  
 MESSAGEBOX\_Create, **2508**  
 MULTIEDIT\_AddKey, **1730**  
 MULTIEDIT\_AddText, **1731**  
 MULTIEDIT\_Create, **1732**  
 MULTIEDIT\_CreateEx, **1733**, 1752, 1753  
 MULTIEDIT\_CreateIndirect, **1734**  
 MULTIEDIT\_CreateUser, **1735**  
 MULTIEDIT\_EnableBlink, **1736**  
 MULTIEDIT\_EnableMotion, **1737**  
 MULTIEDIT\_GetBkColor, **1738**  
 MULTIEDIT\_GetCursorCharPos, **1739**  
 MULTIEDIT\_GetCursorPixelPos, **1740**  
 MULTIEDIT\_GetDefaultAlign, **1741**  
 MULTIEDIT\_GetDefaultBkColor, **1742**  
 MULTIEDIT\_GetDefaultCursorColor, **1743**  
 MULTIEDIT\_GetDefaultFont, **1744**  
 MULTIEDIT\_GetDefaultHBorder, **1745**  
 MULTIEDIT\_GetDefaultTextColor, **1746**  
 MULTIEDIT\_GetFont, **1747**  
 MULTIEDIT\_GetNumChars, **1748**  
 MULTIEDIT\_GetPrompt, **1749**  
 MULTIEDIT\_GetText, **1750**  
 MULTIEDIT\_GetTextColor, **1751**  
 MULTIEDIT\_GetTextFromLine, **1752**, 1752, 1752  
 MULTIEDIT\_GetTextFromPos, **1753**, 1753, 1753, 1753  
 MULTIEDIT\_GetTextSize, **1754**  
 MULTIEDIT\_GetUserData, **1755**  
 MULTIEDIT\_SetAutoScrollH, **1756**  
 MULTIEDIT\_SetAutoScrollV, **1757**  
 MULTIEDIT\_SetBkColor, **1758**  
 MULTIEDIT\_SetBufferSize, **1759**  
 MULTIEDIT\_SetCursorCharPos, **1760**  
 MULTIEDIT\_SetCursorColor, **1761**  
 MULTIEDIT\_SetCursorOffset, **1762**  
 MULTIEDIT\_SetCursorPixelPos, **1763**  
 MULTIEDIT\_SetDefaultAlign, **1764**  
 MULTIEDIT\_SetDefaultBkColor, **1765**  
 MULTIEDIT\_SetDefaultCursorColor, **1766**  
 MULTIEDIT\_SetDefaultFont, **1767**  
 MULTIEDIT\_SetDefaultHBorder, **1768**  
 MULTIEDIT\_SetDefaultTextColor, **1769**  
 MULTIEDIT\_SetFocusable, **1770**  
 MULTIEDIT\_SetFont, **1771**  
 MULTIEDIT\_SetHBorder, **1772**  
 MULTIEDIT\_SetInsertMode, **1773**  
 MULTIEDIT\_SetInvertCursor, **1774**  
 MULTIEDIT\_SetMaxNumChars, **1775**  
 MULTIEDIT\_SetPasswordMode, **1776**  
 MULTIEDIT\_SetPrompt, **1777**  
 MULTIEDIT\_SetReadOnly, **1778**  
 MULTIEDIT\_SetText, **1779**  
 MULTIEDIT\_SetTextAlign, **1780**  
 MULTIEDIT\_SetTextColor, **1781**  
 MULTIEDIT\_SetUserData, **1782**  
 MULTIEDIT\_SetWrapChar, **1783**  
 MULTIEDIT\_SetWrapNone, **1784**  
 MULTIEDIT\_SetWrapWord, **1785**  
 MULTIEDIT\_ShowCursor, **1786**  
 MULTIPAGE\_AddEmptyPage, **1796**  
 MULTIPAGE\_AddPage, **1797**  
 MULTIPAGE\_AttachWindow, **1798**  
 MULTIPAGE\_CreateEx, **1799**

MULTIPAGE\_CreateIndirect, **1800**  
 MULTIPAGE\_CreateUser, **1801**  
 MULTIPAGE\_DeletePage, **1802**  
 MULTIPAGE\_DisablePage, **1803**  
 MULTIPAGE\_EnablePage, **1804**  
 MULTIPAGE\_EnableScrollbar, **1805**  
 MULTIPAGE\_GetBkColor, **1806**  
 MULTIPAGE\_GetDefaultAlign, **1807**  
 MULTIPAGE\_GetDefaultBkColor, **1808**  
 MULTIPAGE\_GetDefaultFont, **1809**  
 MULTIPAGE\_GetDefaultTextColor, **1810**  
 MULTIPAGE\_GetFont, **1811**  
 MULTIPAGE\_GetNumTabs, **1812**  
 MULTIPAGE\_GetPageText, **1813**  
 MULTIPAGE\_GetSelection, **1814**  
 MULTIPAGE\_GetTabHeight, **1815**  
 MULTIPAGE\_GetTabWidth, **1816**  
 MULTIPAGE\_GetTextColor, **1817**  
 MULTIPAGE\_GetUserData, **1818**  
 MULTIPAGE\_GetWindow, **1819**  
 MULTIPAGE\_IsPageEnabled, **1820**  
 MULTIPAGE\_SelectPage, **1821**  
 MULTIPAGE\_SetAlign, **1822**  
 MULTIPAGE\_SetBitmap, **1823**  
 MULTIPAGE\_SetBitmapEx, **1824**  
 MULTIPAGE\_SetBkColor, **1825**  
 MULTIPAGE\_SetDefaultAlign, **1826**  
 MULTIPAGE\_SetDefaultBkColor, **1827**  
 MULTIPAGE\_SetDefaultBorderSizeX, **1828**  
 MULTIPAGE\_SetDefaultBorderSizeY, **1829**  
 MULTIPAGE\_SetDefaultFont, **1830**  
 MULTIPAGE\_SetDefaultTextColor, **1831**  
 MULTIPAGE\_SetFont, **1832**  
 MULTIPAGE\_SetRotation, **1833**  
 MULTIPAGE\_SetSkinFlexProps, **2559**  
 MULTIPAGE\_SetTabHeight, **1834**  
 MULTIPAGE\_SetTabWidth, **1835**  
 MULTIPAGE\_SetText, **1836**  
 MULTIPAGE\_SetTextAlign, **1837**  
 MULTIPAGE\_SetTextColor, **1838**  
 MULTIPAGE\_SetUserData, **1839**  
 PROGBAR\_Create, **985, 1847**  
 PROGBAR\_CreateAsChild, **1848**  
 PROGBAR\_CreateEx, **1849**  
 PROGBAR\_CreateIndirect, **1850**  
 PROGBAR\_CreateUser, **1851**  
 PROGBAR\_GetBarColor, **1852**  
 PROGBAR\_GetFont, **1853**  
 PROGBAR\_GetMinMax, **1854**  
 PROGBAR\_GetTextColor, **1855**  
 PROGBAR\_GetUserData, **1856**  
 PROGBAR\_GetValue, **1857**  
 PROGBAR\_SetBarColor, **986, 986, 1858**  
 PROGBAR\_SetFont, **1859**  
 PROGBAR\_SetMinMax, **1860**  
 PROGBAR\_SetSkinFlexProps, **2564**  
 PROGBAR\_SetText, **1861**  
 PROGBAR\_SetTextAlign, **1862**  
 PROGBAR\_SetTextColor, **1863**  
 PROGBAR\_SetTextPos, **1864**  
 PROGBAR\_SetUserData, **1865**  
 PROGBAR\_SetValue, **986, 1866**  
 QRCODE\_CreateIndirect, **1871**  
 QRCODE\_CreateUser, **1872**  
 QRCODE\_SetEccLevel, **1873**  
 QRCODE\_SetPixelSize, **1875**  
 QRCODE\_SetText, **1876**  
 QRCODE\_SetVersion, **1874**  
 QRCODE\_SetWiFiText, **1877**  
 RADIO\_Create, **1883**  
 RADIO\_CreateEx, **1884, 1908, 1908**  
 RADIO\_CreateIndirect, **1885**  
 RADIO\_CreateUser, **1886**  
 RADIO\_Dec, **1887**  
 RADIO\_GetBkColor, **1888**  
 RADIO\_GetDefaultFont, **1889**

RADIO\_GetDefaultTextColor, **1890**  
 RADIO\_GetFocusColor, **1891**  
 RADIO\_GetFont, **1892**  
 RADIO\_GetImage, **1893**  
 RADIO\_GetNumItems, **1894**  
 RADIO\_GetSpacing, **1895**  
 RADIO\_GetText, **1896**  
 RADIO\_GetTextColor, **1897**  
 RADIO\_GetUserData, **1898**  
 RADIO\_GetValue, **1899**  
 RADIO\_Inc, **1900**  
 RADIO\_SetBkColor, **1901**  
 RADIO\_SetDefaultFocusColor, **1902**  
 RADIO\_SetDefaultFont, **1903**  
 RADIO\_SetDefaultImage, **1904**  
 RADIO\_SetDefaultTextColor, **1905**  
 RADIO\_SetFocusColor, **1906**  
 RADIO\_SetFont, **1907**  
 RADIO\_SetGroupId, **1908**, 1908, 1908  
 RADIO\_SetImage, **1909**  
 RADIO\_SetSkinFlexProps, **2569**  
 RADIO\_SetSpacing, **1910**  
 RADIO\_SetText, 1908, 1908, 1908, 1908, 1908, 1908, **1911**, 1911, 1911, 1911  
 RADIO\_SetTextColor, **1912**  
 RADIO\_SetUserData, **1913**  
 RADIO\_SetValue, **1914**  
 ROTARY\_AddAngle, **1920**  
 ROTARY\_AddValue, **1921**  
 ROTARY\_CreateEx, **1922**  
 ROTARY\_CreateIndirect, **1923**  
 ROTARY\_CreateUser, **1924**  
 ROTARY\_GetAngle, **1925**  
 ROTARY\_GetImageSize, **1926**  
 ROTARY\_GetMarkerSize, **1927**  
 ROTARY\_GetUserData, **1928**  
 ROTARY\_GetValue, **1929**  
 ROTARY\_SetAngle, **1930**  
 ROTARY\_SetBitmap, **1931**  
 ROTARY\_SetDoRotate, **1932**  
 ROTARY\_SetMarker, **1933**  
 ROTARY\_SetOffset, **1934**  
 ROTARY\_SetPeriod, **1935**  
 ROTARY\_SetRadius, **1936**  
 ROTARY\_SetRange, **1937**  
 ROTARY\_SetSnap, **1938**  
 ROTARY\_SetTickSize, **1939**  
 ROTARY\_SetUserData, **1940**  
 ROTARY\_SetValue, **1941**  
 ROTARY\_SetValueRange, **1942**  
 SCROLLBAR\_AddValue, **2424**  
 SCROLLBAR\_Create, **2425**  
 SCROLLBAR\_CreateAttached, **2426**, 2426  
 SCROLLBAR\_CreateEx, **2427**  
 SCROLLBAR\_CreateIndirect, **2428**  
 SCROLLBAR\_CreateUser, **2429**  
 SCROLLBAR\_Dec, **2430**  
 SCROLLBAR\_GetColor, **2431**  
 SCROLLBAR\_GetDefaultWidth, **2432**  
 SCROLLBAR\_GetNumItems, **2433**  
 SCROLLBAR\_GetPageSize, **2434**  
 SCROLLBAR\_GetThumbSizeMin, **2435**  
 SCROLLBAR\_GetUserData, **2436**  
 SCROLLBAR\_GetValue, **2437**  
 SCROLLBAR\_Inc, **2438**  
 SCROLLBAR\_SetColor, **2439**  
 SCROLLBAR\_SetDefaultColor, **2440**  
 SCROLLBAR\_SetDefaultWidth, **2441**  
 SCROLLBAR\_SetNumItems, **2442**  
 SCROLLBAR\_SetPageSize, **2443**  
 SCROLLBAR\_SetSkinFlexProps, **2574**  
 SCROLLBAR\_SetState, **2444**  
 SCROLLBAR\_SetThumbSizeMin, **2445**  
 SCROLLBAR\_SetUserData, **2446**  
 SCROLLBAR\_SetValue, **2447**  
 SCROLLBAR\_SetWidth, **2448**  
 SCROLLER\_AttachToWindow, **1955**

SCROLLER\_CreateAttached, 1947, 1951, **1956**  
 SCROLLER\_CreateIndirect, **1957**  
 SCROLLER\_CreateUser, **1958**  
 SCROLLER\_EnableAutoResize, **1959**  
 SCROLLER\_EnableFade, **1960**  
 SCROLLER\_EnableTouch, **1961**  
 SCROLLER\_GetAlign, **1962**  
 SCROLLER\_GetAlignOffset, **1963**  
 SCROLLER\_GetAnimEase, **1964**  
 SCROLLER\_GetBkColor, **1965**  
 SCROLLER\_GetColor, **1966**  
 SCROLLER\_GetDefaultAlign, **1967**  
 SCROLLER\_GetDefaultAlignOffset, **1968**  
 SCROLLER\_GetDefaultAnimEase, **1969**  
 SCROLLER\_GetDefaultBkColor, **1970**  
 SCROLLER\_GetDefaultColor, **1971**  
 SCROLLER\_GetDefaultPeriod, **1972**  
 SCROLLER\_GetDefaultRadius, **1973**  
 SCROLLER\_GetDefaultSize, **1975**  
 SCROLLER\_GetDefaultSpacing, **1976**  
 SCROLLER\_GetDefaultThumbSizeMin, **1974**  
 SCROLLER\_GetPeriod, **1977**  
 SCROLLER\_GetRadius, **1978**  
 SCROLLER\_GetScrollState, **1979**  
 SCROLLER\_GetSize, **1980**  
 SCROLLER\_GetSpacing, **1981**  
 SCROLLER\_GetThumbRect, **1982**  
 SCROLLER\_GetThumbSizeMin, **1983**  
 SCROLLER\_GetUserData, **1984**  
 SCROLLER\_OwnerDraw, **1985**  
 SCROLLER\_ParentMsgHandler, 1950, **1987**  
 SCROLLER\_PreventIntersect, **1988**  
 SCROLLER\_SetAlign, **1989**  
 SCROLLER\_SetAlignOffset, **1990**  
 SCROLLER\_SetAnimEase, **1991**  
 SCROLLER\_SetBkColor, **1992**  
 SCROLLER\_SetColor, **1993**  
 SCROLLER\_SetDefaultAlign, **1994**  
 SCROLLER\_SetDefaultAlignOffset, **1995**  
 SCROLLER\_SetDefaultAnimEase, **1996**  
 SCROLLER\_SetDefaultBkColor, **1997**  
 SCROLLER\_SetDefaultColor, **1998**  
 SCROLLER\_SetDefaultPeriod, **1999**  
 SCROLLER\_SetDefaultRadius, **2000**  
 SCROLLER\_SetDefaultSize, **2002**  
 SCROLLER\_SetDefaultSpacing, **2003**  
 SCROLLER\_SetDefaultThumbSizeMin, **2001**  
 SCROLLER\_SetInterfaceAPI, 1951, **2004**  
 SCROLLER\_SetOwnerDraw, **2005**  
 SCROLLER\_SetPeriod, **2006**  
 SCROLLER\_SetRadius, **2007**  
 SCROLLER\_SetScrollState, 1948, **2008**  
 SCROLLER\_SetSize, **2009**  
 SCROLLER\_SetSpacing, **2010**  
 SCROLLER\_SetState, **2011**  
 SCROLLER\_SetThumbSizeMin, **2012**  
 SCROLLER\_SetUserData, **2013**  
 SIM\_GUI\_CreateLCDInfoWindow, **211**, 211  
 SIM\_GUI\_CreateLCDWindow, 208, 209, **212**  
 SIM\_GUI\_Delay, **177**  
 SIM\_GUI\_Enable, 207, 209, **213**  
 SIM\_GUI\_EnableModifierKey, **178**  
 SIM\_GUI\_ExecIdle, **179**  
 SIM\_GUI\_Exit, 208, **214**  
 SIM\_GUI\_GetCompositeTouch, **180**  
 SIM\_GUI\_GetTime, **181**  
 SIM\_GUI\_HandleKeyEvents, 207  
 SIM\_GUI\_Init, 208, 209, **215**  
 SIM\_GUI\_IsModifierKeyEnabled, **182**  
 SIM\_GUI\_SaveBMP, **183**  
 SIM\_GUI\_SaveBMPEX, **184**  
 SIM\_GUI\_SaveCompositeBMP, **185**  
 SIM\_GUI\_SetCallback, **186**  
 SIM\_GUI\_SetCompositeColor, **187**  
 SIM\_GUI\_SetCompositeSize, **188**, 2910  
 SIM\_GUI\_SetCompositeTouch, **189**

SIM\_GUI\_SetLCDColorBlack, **190**, 190, 190  
 SIM\_GUI\_SetLCDColorWhite, **190**, 190, 190  
 SIM\_GUI\_SetLCDPos, 175, 190, 190, **192**  
 SIM\_GUI\_SetLCDWindowHook, **216**  
 SIM\_GUI\_SetMag, **193**  
 SIM\_GUI\_SetTransColor, **194**  
 SIM\_GUI\_SetTransMode, **195**, 2910, 2910, 2910  
 SIM\_GUI\_ShowDevice, **196**  
 SIM\_GUI\_UseCustomBitmaps, **197**  
 SIM\_HARDKEY\_GetNum, **201**  
 SIM\_HARDKEY\_GetState, **202**  
 SIM\_HARDKEY\_SetCallback, **203**  
 SIM\_HARDKEY\_SetMode, **204**  
 SIM\_HARDKEY\_SetState, **205**  
 SLIDER\_Create, **2023**  
 SLIDER\_CreateEx, **2024**  
 SLIDER\_CreateIndirect, **2025**, 2453, 2453  
 SLIDER\_CreateUser, **2026**  
 SLIDER\_Dec, **2027**  
 SLIDER\_EnableFocusRect, **2028**  
 SLIDER\_GetBkColor, **2029**  
 SLIDER\_GetFocusColor, **2030**  
 SLIDER\_GetRange, **2031**  
 SLIDER\_GetUserData, **2032**  
 SLIDER\_GetValue, **2033**  
 SLIDER\_Inc, **2034**  
 SLIDER\_SetBkColor, **2035**  
 SLIDER\_SetDefaultFocusColor, **2036**  
 SLIDER\_SetFocusColor, **2037**  
 SLIDER\_SetInvertDir, **2038**  
 SLIDER\_SetNumTicks, **2039**, 2040  
 SLIDER\_SetRange, **2040**, 2040, 2040, 2040  
 SLIDER\_SetSkinFlexProps, **2580**  
 SLIDER\_SetUserData, **2041**  
 SLIDER\_SetValue, **2042**, 2454, 2455  
 SLIDER\_SetWidth, **2043**, 2454, 2455  
 SPINBOX\_CreateEx, **2050**  
 SPINBOX\_CreateIndirect, **2051**  
 SPINBOX\_CreateUser, **2052**  
 SPINBOX\_EnableBlink, **2053**  
 SPINBOX\_GetBkColor, **2054**  
 SPINBOX\_GetButtonBkColor, **2055**  
 SPINBOX\_GetDefaultButtonSize, **2056**  
 SPINBOX\_GetEditHandle, **2057**  
 SPINBOX\_GetFont, **2058**  
 SPINBOX\_GetRange, **2059**  
 SPINBOX\_GetTextColor, **2060**  
 SPINBOX\_GetUserData, **2061**  
 SPINBOX\_GetValue, **2062**  
 SPINBOX\_SetBkColor, **2063**  
 SPINBOX\_SetButtonBkColor, **2064**  
 SPINBOX\_SetButtonSize, **2065**  
 SPINBOX\_SetDefaultButtonSize, **2066**  
 SPINBOX\_SetEdge, **2067**  
 SPINBOX\_SetEditMode, **2068**  
 SPINBOX\_SetFont, **2069**  
 SPINBOX\_SetRange, **2070**  
 SPINBOX\_SetSkinFlexProps, **2585**  
 SPINBOX\_SetStep, **2071**  
 SPINBOX\_SetTextColor, **2072**  
 SPINBOX\_SetTimerPeriod, **2073**  
 SPINBOX\_SetUserData, **2074**  
 SPINBOX\_SetValue, **2075**  
 SWIPELIST\_AddItem, **2088**  
 SWIPELIST\_AddItemText, **2089**  
 SWIPELIST\_AddSepItem, **2090**  
 SWIPELIST\_CreateEx, **2091**  
 SWIPELIST\_CreateIndirect, **2092**  
 SWIPELIST\_CreateUser, **2093**  
 SWIPELIST\_DeleteItem, **2094**  
 SWIPELIST\_GetBitmap, **2095**  
 SWIPELIST\_GetBitmapSpace, **2096**  
 SWIPELIST\_GetBkColor, **2097**  
 SWIPELIST\_GetBorderSize, **2098**  
 SWIPELIST\_GetDefaultBitmapSpace, **2099**  
 SWIPELIST\_GetDefaultBkColor, **2100**



SWIPELIST\_GetDefaultBorderSize, **2101**  
 SWIPELIST\_GetDefaultFont, **2102**  
 SWIPELIST\_GetDefaultOverlap, **2103**  
 SWIPELIST\_GetDefaultSepColor, **2104**  
 SWIPELIST\_GetDefaultSepSize, **2105**  
 SWIPELIST\_GetDefaultTextAlign, **2107**  
 SWIPELIST\_GetDefaultTextColor, **2106**  
 SWIPELIST\_GetDefaultThreshold, **2108**  
 SWIPELIST\_GetFont, **2109**  
 SWIPELIST\_GetItemSize, **2110**  
 SWIPELIST\_GetItemUserData, **2111**  
 SWIPELIST\_GetNumItems, **2112**  
 SWIPELIST\_GetNumText, **2113**  
 SWIPELIST\_GetOverlap, **2114**  
 SWIPELIST\_GetReleasedItem, **2115**  
 SWIPELIST\_GetScrollPos, **2116**  
 SWIPELIST\_GetSelItem, **2117**  
 SWIPELIST\_GetSepColor, **2118**  
 SWIPELIST\_GetSepSize, **2119**  
 SWIPELIST\_GetText, **2120**  
 SWIPELIST\_GetTextAlign, **2121**  
 SWIPELIST\_GetTextColor, **2122**  
 SWIPELIST\_GetThreshold, **2123**  
 SWIPELIST\_GetUserData, **2124**  
 SWIPELIST\_IsSepItem, **2125**  
 SWIPELIST\_ItemAttachWindow, **2126**  
 SWIPELIST\_ItemDetachWindow, **2127**  
 SWIPELIST\_OwnerDraw, **2128**  
 SWIPELIST\_SetAttachedWindowPos, **2129**  
 SWIPELIST\_SetBitmap, **2130**  
 SWIPELIST\_SetBitmapSpace, **2131**  
 SWIPELIST\_SetBkColor, **2132**  
 SWIPELIST\_SetBorderSize, **2133**  
 SWIPELIST\_SetDefaultBitmapSpace, **2134**  
 SWIPELIST\_SetDefaultBkColor, **2135**  
 SWIPELIST\_SetDefaultBorderSize, **2136**  
 SWIPELIST\_SetDefaultFont, **2137**  
 SWIPELIST\_SetDefaultOverlap, **2138**  
 SWIPELIST\_SetDefaultSepColor, **2139**  
 SWIPELIST\_SetDefaultSepSize, **2140**  
 SWIPELIST\_SetDefaultTextAlign, **2142**  
 SWIPELIST\_SetDefaultTextColor, **2141**  
 SWIPELIST\_SetDefaultThreshold, **2143**  
 SWIPELIST\_SetFont, **2144**  
 SWIPELIST\_SetItemSize, **2145**  
 SWIPELIST\_SetItemUserData, **2146**  
 SWIPELIST\_SetOverlap, **2147**  
 SWIPELIST\_SetOwnerDraw, **2148**  
 SWIPELIST\_SetScrollPos, **2149**  
 SWIPELIST\_SetScrollPosItem, **2150**  
 SWIPELIST\_SetSepColor, **2151**  
 SWIPELIST\_SetSepSize, **2152**  
 SWIPELIST\_SetText, **2153**  
 SWIPELIST\_SetTextAlign, **2154**  
 SWIPELIST\_SetTextColor, **2155**  
 SWIPELIST\_SetThreshold, **2156**  
 SWIPELIST\_SetUserData, **2157**  
 SWITCH\_AnimState, **2168**  
 SWITCH\_CreateIndirect, **2169**  
 SWITCH\_CreateUser, **2170**  
 SWITCH\_DisableAnimation, **2171**  
 SWITCH\_GetDefaultFont, **2172**  
 SWITCH\_GetDefaultPeriod, **2173**  
 SWITCH\_GetDefaultTextColor, **2174**  
 SWITCH\_GetState, **2175**  
 SWITCH\_GetUserData, **2176**  
 SWITCH\_SetBitmap, **2177**  
 SWITCH\_SetDefaultFont, **2178**  
 SWITCH\_SetDefaultPeriod, **2179**  
 SWITCH\_SetDefaultTextColor, **2180**  
 SWITCH\_SetFont, **2181**  
 SWITCH\_SetMode, **2182**  
 SWITCH\_SetPeriod, **2183**  
 SWITCH\_SetState, **2184**  
 SWITCH\_SetText, **2185**  
 SWITCH\_SetTextColor, **2186**

SWITCH\_SetUserData, **2187**  
 SWITCH\_Toggle, **2188**  
 TEXT\_Create, **2197**  
 TEXT\_CreateAsChild, **2198**  
 TEXT\_CreateEx, **2199**  
 TEXT\_CreateIndirect, **2200**, 2453, 2453, 2453, 2453  
 TEXT\_CreateUser, **2201**  
 TEXT\_GetBkColor, **2202**  
 TEXT\_GetDefaultFont, **2203**  
 TEXT\_GetDefaultFrameColor, **2204**  
 TEXT\_GetDefaultRotation, **2205**  
 TEXT\_GetDefaultTextColor, **2206**  
 TEXT\_GetDefaultWrapMode, **2207**  
 TEXT\_GetFont, **2208**  
 TEXT\_GetFrameColor, **2209**  
 TEXT\_GetNumLines, **2210**  
 TEXT\_GetRotation, **2211**  
 TEXT\_GetText, **2212**  
 TEXT\_GetTextAlign, **2213**  
 TEXT\_GetTextColor, **2214**  
 TEXT\_GetTextOffset, **2215**  
 TEXT\_GetUserData, **2216**  
 TEXT\_GetWrapMode, **2217**  
 TEXT\_SetBkColor, **2218**  
 TEXT\_SetDec, **2219**  
 TEXT\_SetDefaultFont, **2220**  
 TEXT\_SetDefaultFrameColor, **2221**  
 TEXT\_SetDefaultRotation, **2222**  
 TEXT\_SetDefaultTextColor, **2223**  
 TEXT\_SetDefaultWrapMode, **2224**  
 TEXT\_SetFont, **2225**  
 TEXT\_SetFrameColor, **2226**  
 TEXT\_SetRotation, **2227**  
 TEXT\_SetText, **2228**  
 TEXT\_SetTextAlign, **2229**  
 TEXT\_SetTextColor, **2230**  
 TEXT\_SetTextOffset, **2231**  
 TEXT\_SetUserData, **2232**  
 TEXT\_SetWrapMode, **2233**  
 TREEVIEW\_AttachItem, **2242**  
 TREEVIEW\_CreateEx, **2243**  
 TREEVIEW\_CreateIndirect, **2244**  
 TREEVIEW\_CreateUser, **2245**  
 TREEVIEW\_DecSel, **2246**  
 TREEVIEW\_GetDefaultBkColor, **2247**  
 TREEVIEW\_GetDefaultFont, **2248**  
 TREEVIEW\_GetDefaultLineColor, **2249**  
 TREEVIEW\_GetDefaultTextColor, **2250**  
 TREEVIEW\_GetItem, **2251**  
 TREEVIEW\_GetSel, **2252**  
 TREEVIEW\_GetUserData, **2253**  
 TREEVIEW\_IncSel, **2254**  
 TREEVIEW\_InsertItem, **2255**  
 TREEVIEW\_ITEM\_Collapse, **2276**  
 TREEVIEW\_ITEM\_CollapseAll, **2277**  
 TREEVIEW\_ITEM\_Create, **2278**  
 TREEVIEW\_ITEM\_Delete, **2279**  
 TREEVIEW\_ITEM\_Detach, **2280**  
 TREEVIEW\_ITEM\_Expand, **2281**  
 TREEVIEW\_ITEM\_ExpandAll, **2282**  
 TREEVIEW\_ITEM\_GetInfo, **2283**  
 TREEVIEW\_ITEM\_GetText, **2284**  
 TREEVIEW\_ITEM\_GetUserData, **2285**  
 TREEVIEW\_ITEM\_SetImage, **2286**  
 TREEVIEW\_ITEM\_SetText, **2287**  
 TREEVIEW\_ITEM\_SetUserData, **2288**  
 TREEVIEW\_ScrollToSel, **2256**  
 TREEVIEW\_SetAutoScrollH, **2257**  
 TREEVIEW\_SetAutoScrollV, **2258**  
 TREEVIEW\_SetBitmapOffset, **2259**  
 TREEVIEW\_SetBkColor, **2260**  
 TREEVIEW\_SetDefaultBkColor, **2261**  
 TREEVIEW\_SetDefaultFont, **2262**  
 TREEVIEW\_SetDefaultLineColor, **2263**  
 TREEVIEW\_SetDefaultTextColor, **2264**  
 TREEVIEW\_SetFont, **2265**

TREEVIEW\_SetHasLines, **2266**  
 TREEVIEW\_SetImage, **2267**  
 TREEVIEW\_SetIndent, **2268**  
 TREEVIEW\_SetLineColor, **2269**  
 TREEVIEW\_SetOwnerDraw, **2270**  
 TREEVIEW\_SetSel, **2271**  
 TREEVIEW\_SetSelMode, **2272**  
 TREEVIEW\_SetTextColor, **2273**  
 TREEVIEW\_SetTextIndent, **2274**  
 TREEVIEW\_SetUserData, **2275**  
 WHEEL\_AddBitmaps, **2303**  
 WHEEL\_AddText, **2304**  
 WHEEL\_ClrCenterBitmaps, **2306**  
 WHEEL\_ClrCenterBox, **2305**  
 WHEEL\_ClrCenterText, **2307**  
 WHEEL\_CreateEx, **2308**  
 WHEEL\_CreateIndirect, **2309**  
 WHEEL\_CreateUser, **2310**  
 WHEEL\_DelItemText, **2313**  
 WHEEL\_GetDefaultPeriod, **2311**  
 WHEEL\_GetItemText, **2312, 2312**  
 WHEEL\_GetNumText, **2315**  
 WHEEL\_GetNumTextItems, **2316**  
 WHEEL\_GetReleasedItem, **2317**  
 WHEEL\_GetSel, **2318**  
 WHEEL\_GetUserData, **2319**  
 WHEEL\_InsertItemText, **2320**  
 WHEEL\_IsMoving, **2321**  
 WHEEL\_MoveToPos, **2322**  
 WHEEL\_MoveToPosEx, **2323**  
 WHEEL\_SetAlign, **2324**  
 WHEEL\_SetBkColor, **2325**  
 WHEEL\_SetBox, **2326**  
 WHEEL\_SetCellBitmapAttrMorph, **2331**  
 WHEEL\_SetCellColorPlain, **2332**  
 WHEEL\_SetCenterBitmapAttr, **2327**  
 WHEEL\_SetCenterBitmaps, **2328**  
 WHEEL\_SetCenterBox, **2329**  
 WHEEL\_SetCenterColorPlain, **2330**  
 WHEEL\_SetCenterTextAttrMorph, **2333**  
 WHEEL\_SetCenterTextAttrPlain, **2334**  
 WHEEL\_SetDefaultPeriod, **2335**  
 WHEEL\_SetHBorder, **2336**  
 WHEEL\_SetItemText, **2337**  
 WHEEL\_SetMode, **2338**  
 WHEEL\_SetOverlay, **2339**  
 WHEEL\_SetOverlayColor, **2340**  
 WHEEL\_SetPeriod, **2341**  
 WHEEL\_SetSel, **2342**  
 WHEEL\_SetSizesMorph, **2343**  
 WHEEL\_SetSizesPlain, **2344**  
 WHEEL\_SetUserData, **2345**  
 WIDGET\_GetDefaultEffect, **997**  
 WIDGET\_SetDefaultEffect, **998**  
 WIDGET\_SetEffect, **999**  
 WIDGET\_SetFocusable, **1000**  
 WINDOW\_CreateEx, **2350**  
 WINDOW\_CreateIndirect, **2351**  
 WINDOW\_CreateUser, **2352**  
 WINDOW\_GetUserData, **2353**  
 WINDOW\_SetBkColor, **2354**  
 WINDOW\_SetDefaultBkColor, **2355**  
 WINDOW\_SetUserData, **2356**  
 WM\_Activate, **826**  
 WM\_AttachWindow, **827, 2903**  
 WM\_AttachWindowAt, **828**  
 WM\_BringToBottom, **829**  
 WM\_BringToTop, **830**  
 WM\_BroadcastMessage, **831**  
 WM\_ClrHasTrans, **832**  
 WM\_CreateTimer, **944, 944**  
 WM\_CreateWindow, **811, 833, 833, 833, 844, 901, 944, 980, 981**  
 WM\_CreateWindowAsChild, **806, 811, 834, 844, 844, 2902, 2902, 2902, 2902, 2902, 2902**  
 WM\_Deactivate, **835**  
 WM\_DefaultProc, **802, 836, 836, 844, 901, 944, 980, 980, 1950, 2453, 2454, 2456, 2873**  
 WM\_DeleteTimer, **945**

- WM\_DeleteWindow, **837**, 980, 981, 1299
- WM\_DeleteWindowSecure, **838**
- WM\_DetachWindow, **839**
- WM\_DisableMemdev, **942**
- WM\_DisableWindow, **840**, 2454, 2455
- WM\_EnableMemdev, **943**
- WM\_EnableWindow, **841**
- WM\_Exec, **842**, 842
- WM\_Exec1, **843**
- WM\_ForEachDesc, **844**, 845
- WM\_GetActiveWindow, **846**
- WM\_GetCallback, **847**, 987
- WM\_GetClientRect, **848**
- WM\_GetClientRectEx, **849**, 1949
- WM\_GetClientWindow, 814, **948**
- WM\_GetContentRect, **949**
- WM\_GetContentRectEx, **950**
- WM\_GetDesktopWindow, **850**
- WM\_GetDesktopWindowEx, **851**, 2902, 2902, 2902, 2902, 2902, 2903, 2903
- WM\_GetDlgItem, **852**, 2454, 2454, 2454, 2454, 2454, 2454, 2454, 2454, 2454, 2454, 2454, 2454, 2454, 2454, 2454, 2454, 2454, 2873
- WM\_GetFirstChild, **853**
- WM\_GetFocusedWindow, **854**
- WM\_GetHasTrans, **855**
- WM\_GetId, **951**, 2456, 2873
- WM\_GetInsideRect, **952**
- WM\_GetInsideRectEx, **953**
- WM\_GetInvalidRect, **856**
- WM\_GetModalLayer, **857**
- WM\_GetModalWindow, **858**
- WM\_GetNextSibling, **859**
- WM\_GetNumInvalidWindows, 842, **860**
- WM\_GetOrgX, **861**
- WM\_GetOrgY, **861**
- WM\_GetParent, **862**
- WM\_GetPrevSibling, **863**
- WM\_GetScrollbarH, **954**
- WM\_GetScrollbarV, **955**
- WM\_GetScrollPosH, **956**
- WM\_GetScrollPosV, **957**
- WM\_GetScrollState, **958**
- WM\_GetStayOnTop, **864**
- WM\_GetTimerId, **946**
- WM\_GetUserData, 844, **865**
- WM\_GetWindowOrgX, **866**
- WM\_GetWindowOrgY, **866**
- WM\_GetWindowRect, **867**
- WM\_GetWindowRectEx, **868**
- WM\_GetWindowSizeX, **869**
- WM\_GetWindowSizeY, **869**
- WM\_HasCaptured, **870**
- WM\_HasFocus, **871**
- WM\_HideWindow, **872**, 1949
- WM\_InvalidArea, **873**
- WM\_InvalidRect, **874**
- WM\_InvalidWindow, **875**, 1949, 2512
- WM\_IsCompletelyCovered, **876**
- WM\_IsCompletelyVisible, 814, **877**
- WM\_IsEnabled, **878**
- WM\_IsUntouchable, **879**
- WM\_IsVisible, **880**
- WM\_IsWindow, **881**
- WM\_MakeModal, **882**
- WM\_MOTION\_Enable, **927**
- WM\_MOTION\_SetDeceleration, **928**
- WM\_MOTION\_SetDefaultPeriod, **929**
- WM\_MOTION\_SetMotion, **930**
- WM\_MOTION\_SetMoveable, **931**
- WM\_MOTION\_SetMovement, **932**
- WM\_MOTION\_SetSpeed, **933**
- WM\_MOTION\_SetThreshold, **934**
- WM\_MoveChildTo, **883**
- WM\_MoveTo, **884**
- WM\_MoveWindow, 844, **885**
- WM\_MULTIBUF\_Enable, **941**
- WM\_NotifyParent, **886**

WM\_Paint, **887**  
WM\_Rect2Client, **889**  
WM\_Rect2Screen, **890**  
WM\_ReleaseCapture, **891**  
WM\_ResizeWindow, **892**  
WM\_RestartTimer, 944, **947**  
WM\_Screen2hWin, **893**  
WM\_Screen2hWinEx, **894**  
WM\_SelectWindow, **895**, 895  
WM\_SendMessage, **896**  
WM\_SendMessageNoPara, **897**  
WM\_SendToParent, **898**  
WM\_SetCallback, **899**, 981, 981  
WM\_SetCapture, **900**  
WM\_SetCaptureMove, **901**, 901  
WM\_SetCreateFlags, **902**, 902  
WM\_SetDesktopColor, 811, 844, 901, **903**  
WM\_SetDesktopColorEx, **904**  
WM\_SetEnableState, **905**  
WM\_SetFocus, **906**  
WM\_SetHasTrans, **907**  
WM\_SetId, **908**  
WM\_SetModalLayer, **909**  
WM\_SetpfPollPID, **910**, 910  
WM\_SetScrollPosH, **959**  
WM\_SetScrollPosV, **960**  
WM\_SetScrollState, **961**  
WM\_SetSize, **911**  
WM\_SetStayOnTop, **916**  
WM\_SetTransState, **917**  
WM\_SetUntouchable, **912**  
WM\_SetUserClipRect, **918**, 918, 918  
WM\_SetUserData, 844, 844, 845, **919**  
WM\_SetWindowPos, **913**  
WM\_SetXSize, **914**  
WM\_SetYSize, **915**  
WM\_ShowWindow, **920**, 1949  
WM\_TOOLTIP\_AddTool, 811, **935**  
WM\_TOOLTIP\_Create, 810, 811, **936**  
WM\_TOOLTIP\_Delete, **937**  
WM\_TOOLTIP\_SetDefaultColor, **938**  
WM\_TOOLTIP\_SetDefaultFont, **939**  
WM\_TOOLTIP\_SetDefaultPeriod, **940**  
WM\_Update, **921**  
WM\_ValidateRect, **923**  
WM\_ValidateWindow, **924**  
WM\_XY2Client, **926**  
WM\_XY2Screen, **925**

## 15.2 Type index

CALENDAR\_DATE, **2478**  
 CHOOSEFILE\_INFO, **2503**  
 GUI\_ALPHA\_STATE, 324, **413**  
 GUI\_ANIM\_INFO, 614, **640**  
 GUI\_BITMAP\_STREAM, 1041  
 GUI\_BITMAPSTREAM\_INFO, **414**  
 GUI\_BITMAPSTREAM\_PARAM, 344, **415**  
 GUI\_CALLBACK\_VOID\_U8\_P, 437, 438  
 GUI\_CURSOR\_ANIM, **2785**, 2823  
 GUI\_DEVICE, 2936, 3017, 3023, 3034, 3044, 3061, 3065, 3069  
 GUI\_DIRTYDEVICE\_INFO, **416**  
 GUI\_FONTINFO, 568, **584**  
 GUI\_GIF\_IMAGE\_INFO, **467**  
 GUI\_GIF\_INFO, **468**  
 GUI\_GRADIENT\_INFO, 306, **417**  
 GUI\_JPEG\_INFO, **448**  
 GUI\_KEY\_STATE, **738**  
 GUI\_MEASDEV\_Handle, 2689  
 GUI\_MEMDEV\_Handle, 2637, 2637, 2641, 2646, 2650, 2657, 2657, 2663, 2663, 2674  
 GUI\_MOVIE\_INFO, 649, **670**  
 GUI\_MTOUCH\_EVENT, 2717, **2728**  
 GUI\_MTOUCH\_INPUT, 2717, **2729**  
 GUI\_PID\_STATE, 674, **679**, 682, 689, 710, 817, 901, 901  
 GUI\_POINT, 357, 357, 359, 359, 361, 361, **418**, 418, 2604, 2624, 2624, 2624  
 GUI\_PORT\_API, 2936, 3017, 3023, 3023, 3034, 3044, 3061, 3065, 3069  
 GUI\_QR\_INFO, **419**  
 GUI\_RECT, **420**  
 GUI\_SIGNAL\_EVENT\_FUNC, 2884  
 GUI\_SOFTLAYER\_CONFIG, 2911, **2926**  
 GUI\_TTF\_CS, **585**  
 GUI\_TTF\_DATA, 539, **586**  
 GUI\_WAIT\_EVENT\_FUNC, 2885  
 GUI\_WRAPMODE, 234, **256**  
 IP\_FS\_API, **2756**, 2756  
 KEYBOARD\_CODES, **1504**, 1504  
 KEYDEF\_AREA, **1505**  
 KEYDEF\_BUTTON, **1509**  
 KEYDEF\_KEY, 1488, **1506**, 1506  
 KEYDEF\_KEYBOARD, **1502**, 1503  
 KEYDEF\_LINE, 1504, **1510**, 1510  
 KEYDEF\_SHIFT, 1488, **1507**, 1507  
 KEYDEF\_SWITCH, 1488, **1508**, 1508  
 LCD\_API\_COLOR\_CONV, 501  
 LCD\_COLOR, 134, 134, 501, 501, 501, 502, 2829, 2831, 2904  
 LISTBOX\_Handle, 2426  
 MENU\_ITEM\_DATA, **1716**  
 MENU\_MSG\_DATA, 1676, 1676, **1717**  
 SCROLLER\_INTERFACE\_API, 1951, **2014**, 2014  
 SIM\_GUI\_INFO, **198**  
 TOOLTIP\_INFO, 810, **962**  
 TREEVIEW\_ITEM\_INFO, **2289**  
 WM\_GESTURE\_INFO, **2730**  
 WM\_KEY\_INFO, **963**, 2455  
 WM\_MESSAGE, 802, 811, 811, 817, 836, 844, 901, 944, **964**, 964, 980, 980, 1676, 1950, 2453, 2454, 2455, 2873  
 WM\_MOTION\_INFO, 808, **965**  
 WM\_MOVE\_INFO, **966**  
 WM\_PID\_STATE\_CHANGED\_INFO, **967**  
 WM\_SCROLL\_STATE, **968**, 1948, 1949, 2014  
 WM\_ZOOM\_INFO, **2731**